

NO. OF CKTS.	DIM. A	DIM. B
1	(2.44 ± .15) .096 ± .006	—
2	(4.98 ± .15) .196 ± .006	(2.54 ± .10) .100 ± .004
3	(7.52 ± .15) .296 ± .006	(5.08 ± .10) .200 ± .004
4	(10.06 ± .15) .396 ± .006	(7.62 ± .10) .300 ± .004
5	(12.60 ± .18) .496 ± .007	(10.16 ± .13) .400 ± .005
6	(15.14 ± .18) .596 ± .007	(12.70 ± .13) .500 ± .005
7	(17.68 ± .20) .696 ± .008	(15.24 ± .15) .600 ± .006
8	(20.22 ± .20) .796 ± .008	(17.78 ± .15) .700 ± .006
9	(22.76 ± .20) .896 ± .008	(20.32 ± .15) .800 ± .006
10	(25.30 ± .25) .996 ± .010	(22.86 ± .20) .900 ± .008
11	(27.84 ± .25) 1.096 ± .010	(25.40 ± .20) 1.000 ± .008
12	(30.38 ± .25) 1.196 ± .010	(27.94 ± .20) 1.100 ± .008
13	(32.92 ± .25) 1.296 ± .010	(30.48 ± .20) 1.200 ± .008
14	(35.46 ± .25) 1.396 ± .010	(33.02 ± .20) 1.300 ± .008
15	(38.00 ± .28) 1.496 ± .011	(35.56 ± .23) 1.400 ± .009
16	(40.54 ± .28) 1.596 ± .011	(38.10 ± .23) 1.500 ± .009
17	(43.08 ± .28) 1.696 ± .011	(40.64 ± .23) 1.600 ± .009
18	(45.62 ± .28) 1.796 ± .011	(43.18 ± .23) 1.700 ± .009
19	(48.16 ± .28) 1.896 ± .011	(45.72 ± .23) 1.800 ± .009
20	(50.70 ± .30) 1.996 ± .012	(48.26 ± .25) 1.900 ± .010

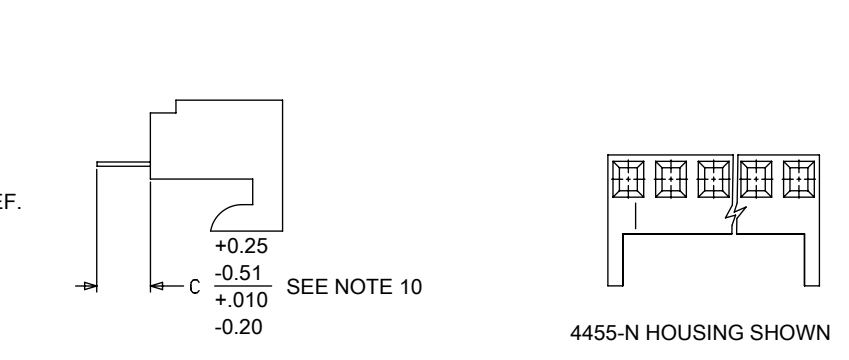

- NOTES:
- MATERIAL: NYLON, UL 94V-0, COLOR: WHITE
 - FINISH:
 - (208) - SELECT GOLD: (0.00038)/.000015 MIN., SELECT TIN: (0.00254)/.000100 MIN. OVERALL NICKEL UNDERPLATE: (0.00127)/.000050 MIN.
 - (228) - SELECT GOLD: (0.00076)/.000030 MIN., SELECT TIN: (0.00254)/.000100 MIN. OVERALL NICKEL UNDERPLATE: (0.00127)/.000050 MIN.
 - (231) - SELECT GOLD: (0.00127)/.000050 MIN., SELECT TIN: (0.00254)/.000100 MIN. OVERALL NICKEL UNDERPLATE: (0.00127)/.000050 MIN.
 - (565) - SELECT GOLD: (0.00051)/.000020 MIN., OVERALL NICKEL: (0.00076)/.000030 MIN. OVERALL GOLD FLASH: (0.00005)/.000002 MIN.
 - (P909) - OVERALL TIN: (0.00254)/.000100 MIN.
 - PARTS CONFORM TO PRODUCT SPECIFICATION PS-10-07.
 - PACKAGING: SEE CHARTS.
 - PARTS MUST CONFORM TO SOLDERABILITY SPEC 152.
 - PARTS ARE STACKABLE END TO END ON (2.54)/.100 CENTERS.
 - TYPICAL PCB THICKNESS: (1.57)/.062
 - PART CONFORMS TO CLASS B REQUIREMENTS OF COSMETIC SPECIFICATION PS-45499-002 EXCEPT PROTRUSIONS. PARTS MAY HAVE MORE THAN 2 GATE MARKS.
 - WHEN MATING ASSEMBLIES THAT USE 4455-BN HOUSINGS TO BREAKAWAY FRICTION LOCK OR POLARIZING HEADERS, THE END BACKWALLS MUST BE REMOVED.
 - DIMENSION C MEASURED WITH TERMINAL PUSHED IN AGAINST THE STOP.

DOCUMENT STATUS	P1	RELEASE DATE	2022/07/29	12:32:02
-----------------	----	--------------	------------	----------

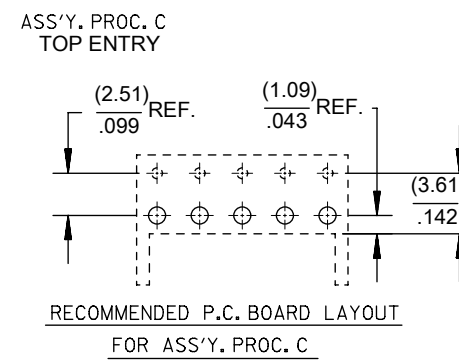
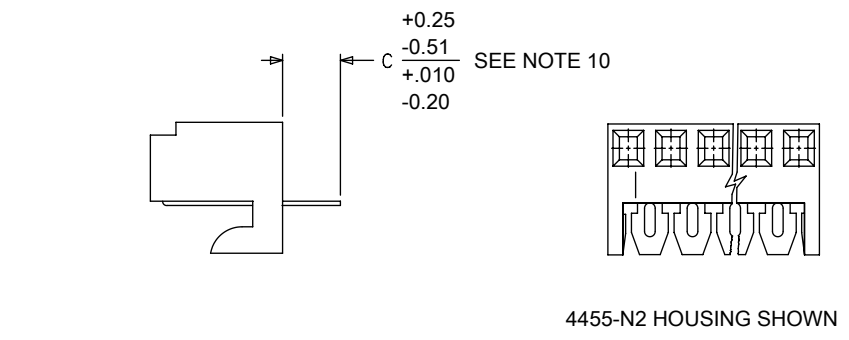
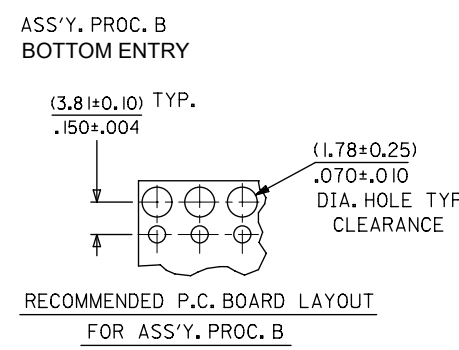
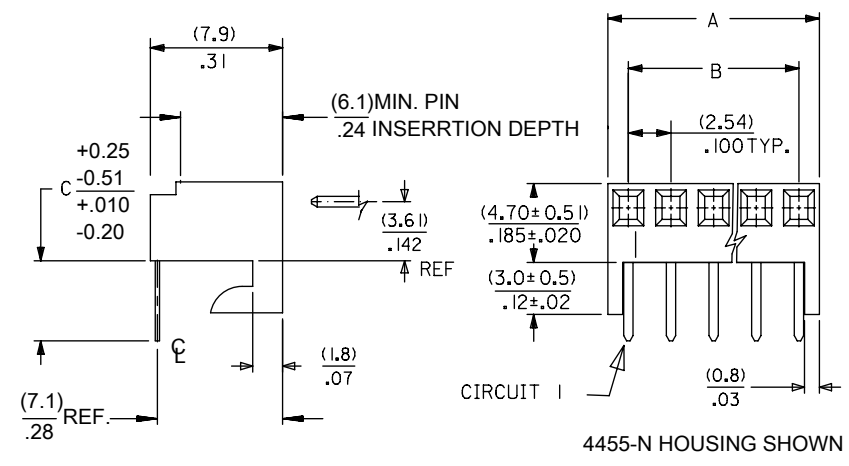
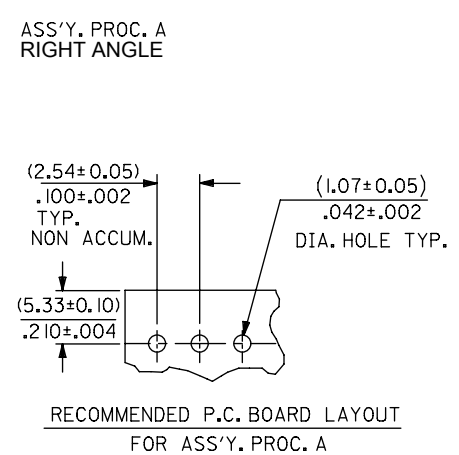
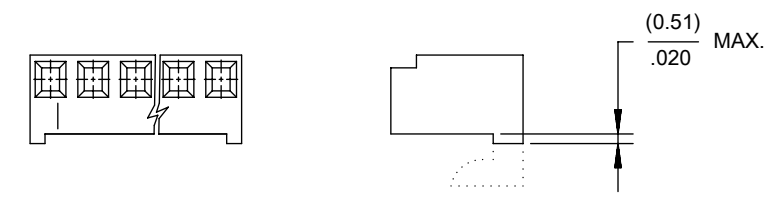
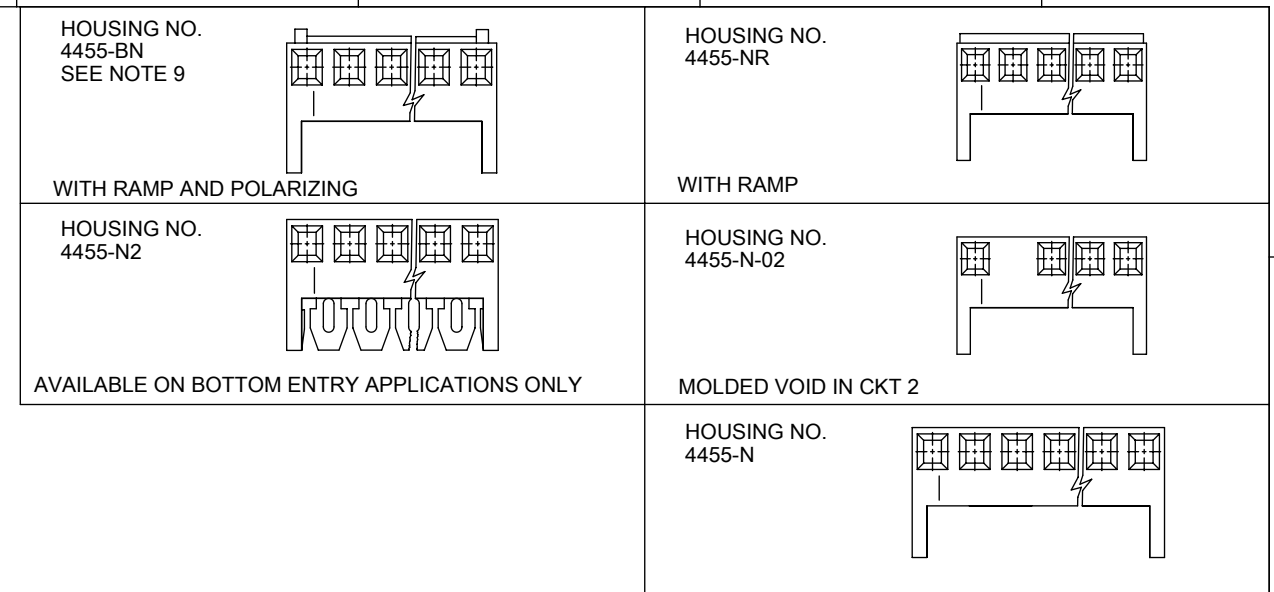

HOOKS CUT OPTION AVAILABLE ON TOP ENTRY, SEE CHART

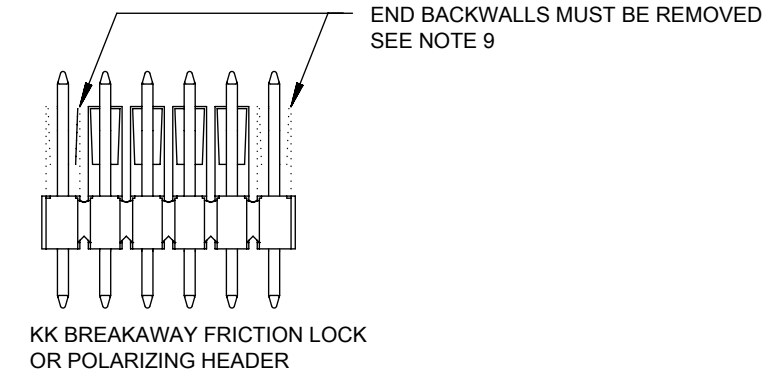

THIS DRAWING CONTAINS INFORMATION THAT IS PROPRIETARY TO MOLEX ELECTRONIC TECHNOLOGIES, LLC AND SHOULD NOT BE USED WITHOUT WRITTEN PERMISSION											
DIMENSION UNITS MM/IN		SCALE 1:1		CURRENT REV DESC: REMOVED OBSOLETE PART NUMBER AS PER PCN#512128.				molex		KK 100 PCB ASSY 4455 SERIES DWG	
GENERAL TOLERANCES (UNLESS SPECIFIED)				EC NO: 716046 DRWN: SANTHN CHKD: GGA APPR: GGA							
4 PLACES ±		±		2022/07/22				PRODUCT CUSTOMER DRAWING		DOCUMENT NUMBER	
3 PLACES ±		± 0.01		2022/07/29				SDA-4455		PSD 001 D18	
2 PLACES ±		± 0.25 ± 0.015		2022/07/29				INITIAL REVISION:		DOC TYPE DOC PART REVISION	
1 PLACE ±		± 0.36 ±		1984/05/10				DRWN: SAMIEC		1984/05/10	
0 PLACES ±		±		1984/05/10				APPR: LENZ		SERIES	
ANGULAR TOL ± 0.5°		±						MATERIAL NUMBER		CUSTOMER	
DRAFT WHERE APPLICABLE MUST REMAIN WITHIN DIMENSIONS		THIRD ANGLE PROJECTION		DRAWING		SERIES		SEE CHART		GENERAL MARKET	
		B-SIZE		4455		SHEET NUMBER		1 OF 15			

KK 100 PCB ASSY 2-25 CKT 4455 SERIES

A-4455- * * N * * - *

ASSY PROCEDURE
 A=RIGHT ANGLE
 B=BOTTOM ENTRY
 C=TOP ENTRY

HOUSING OPTION

- A=4455-AN
- B=4455-BN
- E=4455-NHH
- G=4455-BN (HOOKS CUT OFF)
- H=4455-N2 (BOTTOM ENTRY ONLY)
- P=4455-NR (HOOKS CUT OFF)
- R=4455-NR
- V=4455-N-02
- W=4455-N-02 (HOOKS CUT OFF)
- Y=4455-N (HOOKS CUT OFF)
- Z=4455-N

NO OF CIRCUITS

TERMINAL TYPE

Code	Number	Material	Form
A	4316-4	Brass	Standard
B	6516-4	Phos Bronze	Standard
C	6516-5C	Phos Bronze	Cat Ear / V
D	4316-3B	Brass	Std / V
F	6516-6C	Phos Bronze	Cat Ear / V
G	4316-3	Brass	Standard
J	6516-3B	Phos Bronze	Std / V
L	6516-3C	Phos Bronze	Cat Ear / V
M	6516-4A	Phos Bronze	Cat Ear
T	4316-4A	Brass	Cat Ear

PLATING

(SEE SHEET 1)

VOID LOCATION
 NUMBER = CIRCUIT VOIDED
 MULTIPLE VOIDS START
 WITH 51
 BLANK = NONE

Ckts	Assy Proc:	RIGHT ANGLE	Assy Proc:	RIGHT ANGLE
		Hooks Cut:	NO	Hooks Cut:
	Housing No:	4455-N	Housing No:	4455-N
	Terminal No:	4316-4(P909)	Terminal No:	4316-4(565)
	Dim C:	3.35 / .132	Dim C:	3.35 / .132
	Plating:	P909	Plating:	565
	Packaging:	PK-44646-001	Packaging:	PK-44646-001
	Voids:	NONE	Voids:	NONE
Material No	Engineer Number	Material No	Engineer Number	
2	22-15-2026	A-4455-AZ02A(P909)	22-16-2021	A-4455-AZ02A(565)
3	22-15-2036	A-4455-AZ03A(P909)	22-16-2031	A-4455-AZ03A(565)
4	22-15-2046	A-4455-AZ04A(P909)	22-16-2041	A-4455-AZ04A(565)
5	22-15-2056	A-4455-AZ05A(P909)	22-16-2051	A-4455-AZ05A(565)
6	22-15-2066	A-4455-AZ06A(P909)	22-16-2061	A-4455-AZ06A(565)
7	22-15-2076	A-4455-AZ07A(P909)	22-16-2071	A-4455-AZ07A(565)
8	22-15-2086	A-4455-AZ08A(P909)	22-16-2081	A-4455-AZ08A(565)
9	22-15-2096	A-4455-AZ09A(P909)	22-16-2091	A-4455-AZ09A(565)
10	22-15-2106	A-4455-AZ10A(P909)	22-16-2101	A-4455-AZ10A(565)
11	22-15-2116	A-4455-AZ11A(P909)	22-16-2111	A-4455-AZ11A(565)
12	22-15-2126	A-4455-AZ12A(P909)	22-16-2121	A-4455-AZ12A(565)
13	22-15-2136	A-4455-AZ13A(P909)	22-16-2131	A-4455-AZ13A(565)
14	22-15-2146	A-4455-AZ14A(P909)	22-16-2141	A-4455-AZ14A(565)
15	22-15-2156	A-4455-AZ15A(P909)	22-16-2151	A-4455-AZ15A(565)
16	22-15-2166	A-4455-AZ16A(P909)	22-16-2161	A-4455-AZ16A(565)
17	22-15-2176	A-4455-AZ17A(P909)	22-16-2171	A-4455-AZ17A(565)
18	22-15-2186	A-4455-AZ18A(P909)	22-16-2181	A-4455-AZ18A(565)
19	22-15-2196	A-4455-AZ19A(P909)	22-16-2191	A-4455-AZ19A(565)
20	22-15-2206	A-4455-AZ20A(P909)	22-16-2201	A-4455-AZ20A(565)
21				
22				
23				
24				
25				

THIS DRAWING CONTAINS INFORMATION THAT IS PROPRIETARY TO MOLEX ELECTRONIC TECHNOLOGIES, LLC AND SHOULD NOT BE USED WITHOUT WRITTEN PERMISSION											
DIMENSION UNITS MM/IN		SCALE 1:1		CURRENT REV DESC: REMOVED OBSOLETE PART NUMBER AS PER PCN#512128.				molex			
GENERAL TOLERANCES (UNLESS SPECIFIED)				EC NO: 716046 DRWN: SANTHN CHKD: GGA APPR: GGA INITIAL REVISION: DRWN: SAMIEC APPR: LENZ				KK 100 PCB ASSY 4455 SERIES DWG			
4 PLACES ±		±						2022/07/22			
3 PLACES ±		± 0.01						2022/07/29			
2 PLACES ± 0.25		± 0.015						2022/07/29			
1 PLACE ± 0.36		±						1984/05/10 1984/05/10			
0 PLACES ±		±									
ANGULAR TOL ± 0.5°		±		PRODUCT CUSTOMER DRAWING DOCUMENT NUMBER: SDA-4455 DOC TYPE: PSD DOC PART: 001 REVISION: D18							
DRAFT WHERE APPLICABLE MUST REMAIN WITHIN DIMENSIONS		THIRD ANGLE PROJECTION		DRAWING		SERIES		MATERIAL NUMBER		CUSTOMER	
				B-SIZE		4455		SEE CHART		GENERAL MARKET	
DOCUMENT STATUS		P1		RELEASE DATE		2022/07/29 12:32:02		2 OF 15			

KK 100 PCB ASSY 2-25 CKT 4455 SERIES

STANDARD PRODUCT

Ckts	Assy Proc: RIGHT ANGLE		Assy Proc: BOTTOM ENTRY		Assy Proc: BOTTOM ENTRY		Assy Proc: BOTTOM ENTRY	
	Material No	Engineer Number	Material No	Engineer Number	Material No	Engineer Number	Material No	Engineer Number
2	22-16-2020	A-4455-AZ02A(208)	22-14-2024	A-4455-BH02D(P909)	22-17-2022	A-4455-BH02D(565)	22-17-3022	A-4455-BH02D(208)
3	22-16-2030	A-4455-AZ 03 A(208)	22-14-2034	A-4455-BH 03 D(P909)	22-17-2032	A-4455-BH 03 D(565)	22-17-3032	A-4455-BH 03 D(208)
4	22-16-2040	A-4455-AZ 04 A(208)	22-14-2044	A-4455-BH 04 D(P909)	22-17-2042	A-4455-BH 04 D(565)	22-17-3042	A-4455-BH 04 D(208)
5	22-16-2050	A-4455-AZ 05 A(208)	22-14-2054	A-4455-BH 05 D(P909)	22-17-2052	A-4455-BH 05 D(565)	22-17-3052	A-4455-BH 05 D(208)
6	22-16-2060	A-4455-AZ 06 A(208)	22-14-2064	A-4455-BH 06 D(P909)	22-17-2062	A-4455-BH 06 D(565)	22-17-3062	A-4455-BH 06 D(208)
7	22-16-2070	A-4455-AZ 07 A(208)	22-14-2074	A-4455-BH 07 D(P909)	22-17-2072	A-4455-BH 07 D(565)	22-17-3072	A-4455-BH 07 D(208)
8	22-16-2080	A-4455-AZ 08 A(208)	22-14-2084	A-4455-BH 08 D(P909)	22-17-2082	A-4455-BH 08 D(565)	22-17-3082	A-4455-BH 08 D(208)
9	22-16-2090	A-4455-AZ 09 A(208)	22-14-2094	A-4455-BH 09 D(P909)	22-17-2092	A-4455-BH 09 D(565)	22-17-3092	A-4455-BH 09 D(208)
10	22-16-2100	A-4455-AZ 10 A(208)	22-14-2104	A-4455-BH 10 D(P909)	22-17-2102	A-4455-BH 10 D(565)	22-17-3102	A-4455-BH 10 D(208)
11	22-16-2110	A-4455-AZ 11 A(208)	22-14-2114	A-4455-BH 11 D(P909)	22-17-2112	A-4455-BH 11 D(565)	22-17-3112	A-4455-BH 11 D(208)
12	22-16-2120	A-4455-AZ 12 A(208)	22-14-2124	A-4455-BH 12 D(P909)	22-17-2122	A-4455-BH 12 D(565)	22-17-3122	A-4455-BH 12 D(208)
13	22-16-2130	A-4455-AZ 13 A(208)	22-14-2134	A-4455-BH 13 D(P909)	22-17-2132	A-4455-BH 13 D(565)	22-17-3132	A-4455-BH 13 D(208)
14	22-16-2140	A-4455-AZ 14 A(208)	22-14-2144	A-4455-BH 14 D(P909)	22-17-2142	A-4455-BH 14 D(565)	22-17-3142	A-4455-BH 14 D(208)
15	22-16-2150	A-4455-AZ 15 A(208)	22-14-2154	A-4455-BH 15 D(P909)	22-17-2152	A-4455-BH 15 D(565)	22-17-3152	A-4455-BH 15 D(208)
16	22-16-2160	A-4455-AZ 16 A(208)	22-14-2164	A-4455-BH 16 D(P909)	22-17-2162	A-4455-BH 16 D(565)	22-17-3162	A-4455-BH 16 D(208)
17	22-16-2170	A-4455-AZ 17 A(208)	22-14-2174	A-4455-BH 17 D(P909)	22-17-2172	A-4455-BH 17 D(565)	22-17-3172	A-4455-BH 17 D(208)
18	22-16-2180	A-4455-AZ 18 A(208)	22-14-2184	A-4455-BH 18 D(P909)			22-17-3182	A-4455-BH 18 D(208)
19	22-16-2190	A-4455-AZ 19 A(208)	22-14-2194	A-4455-BH 19 D(P909)			22-17-3192	A-4455-BH 19 D(208)
20	22-16-2200	A-4455-AZ 20 A(208)	22-14-2204	A-4455-BH 20 D(P909)	22-17-2202	A-4455-BH 20 D(565)	22-17-3202	A-4455-BH 20 D(208)
21								
22								
23	22-16-2230	A-4455-AZ 23 A(208)						
24								
25								

THIS DRAWING CONTAINS INFORMATION THAT IS PROPRIETARY TO MOLEX ELECTRONIC TECHNOLOGIES, LLC AND SHOULD NOT BE USED WITHOUT WRITTEN PERMISSION									
DIMENSION UNITS MM/IN	SCALE 1:1	CURRENT REV DESC: REMOVED OBSOLETE PART NUMBER AS PER PCN#512128.			molex				
GENERAL TOLERANCES (UNLESS SPECIFIED)				EC NO: 716046		KK 100 PCB ASSY 4455 SERIES DWG			
4 PLACES ± ±				DRWN: SANTHN					
3 PLACES ± ± 0.01				2022/07/22		PRODUCT CUSTOMER DRAWING			
2 PLACES ± 0.25 ± 0.015				CHKD: GGA					
1 PLACE ± 0.36 ±				2022/07/29		DOCUMENT NUMBER DOC TYPE DOC PART REVISION			
0 PLACES ± ±				APPR: GGA					
ANGULAR TOL ± 0.5°				INITIAL REVISION:		SDA-4455 PSD 001 D18			
DRAFT WHERE APPLICABLE MUST REMAIN WITHIN DIMENSIONS				DRWN: SAMIEC					
THIRD ANGLE PROJECTION				1984/05/10		MATERIAL NUMBER CUSTOMER SHEET NUMBER			
DRAWING SERIES				1984/05/10					
B-SIZE				4455		SEE CHART GENERAL MARKET 3 OF 15			

KK 100 PCB ASSY 2-25 CKT 4455 SERIES

Ckts	Assy Proc: TOP ENTRY		Assy Proc: TOP ENTRY		Assy Proc: TOP ENTRY		Assy Proc: RIGHT ANGLE	
	Material No	Engineer Number	Material No	Engineer Number	Material No	Engineer Number	Material No	Engineer Number
2	22-02-2025	A-4455-CZ02A(P909)	22-18-2023	A-4455-CZ02A(565)	22-18-2021	A-4455-CZ02A(208)	22-15-4025	A-4455-AZ02B(P909)
3	22-02-2035	A-4455-CZ 03A(P909)	22-18-2033	A-4455-CZ 03 A(565)	22-18-2031	A-4455-CZ 03 A(208)	22-15-4035	A-4455-AZ 03B(P909)
4	22-02-2045	A-4455-CZ 04A(P909)	22-18-2043	A-4455-CZ 04 A(565)	22-18-2041	A-4455-CZ 04 A(208)	22-15-4045	A-4455-AZ 04B(P909)
5	22-02-2055	A-4455-CZ 05A(P909)	22-18-2053	A-4455-CZ 05 A(565)	22-18-2051	A-4455-CZ 05 A(208)	22-15-4055	A-4455-AZ 05B(P909)
6	22-02-2065	A-4455-CZ 06A(P909)	22-18-2063	A-4455-CZ 06 A(565)	22-18-2061	A-4455-CZ 06 A(208)	22-15-4065	A-4455-AZ 06B(P909)
7	22-02-2075	A-4455-CZ 07A(P909)	22-18-2073	A-4455-CZ 07 A(565)	22-18-2071	A-4455-CZ 07 A(208)	22-15-4075	A-4455-AZ 07B(P909)
8	22-02-2085	A-4455-CZ 08 A(P909)	22-18-2083	A-4455-CZ 08 A(565)	22-18-2081	A-4455-CZ 08 A(208)	22-15-4085	A-4455-AZ 08B(P909)
9	22-02-2095	A-4455-CZ 09 A(P909)	22-18-2093	A-4455-CZ 09 A(565)	22-18-2091	A-4455-CZ 09 A(208)	22-15-4095	A-4455-AZ 09B(P909)
10	22-02-2105	A-4455-CZ 10 A(P909)	22-18-2103	A-4455-CZ 10 A(565)	22-18-2101	A-4455-CZ 10 A(208)	22-15-4105	A-4455-AZ 10B(P909)
11	22-02-2115	A-4455-CZ 11 A(P909)	22-18-2113	A-4455-CZ 11 A(565)	22-18-2111	A-4455-CZ 11 A(208)	22-15-4115	A-4455-AZ 11B(P909)
12	22-02-2125	A-4455-CZ 12 A(P909)	22-18-2123	A-4455-CZ 12 A(565)	22-18-2121	A-4455-CZ 12 A(208)	22-15-4125	A-4455-AZ 12B(P909)
13	22-02-2135	A-4455-CZ 13 A(P909)	22-18-2133	A-4455-CZ 13 A(565)	22-18-2131	A-4455-CZ 13 A(208)	22-15-4135	A-4455-AZ 13B(P909)
14	22-02-2145	A-4455-CZ 14 A(P909)	22-18-2143	A-4455-CZ 14 A(565)	22-18-2141	A-4455-CZ 14 A(208)	22-15-4145	A-4455-AZ 14B(P909)
15	22-02-2155	A-4455-CZ 15 A(P909)			22-18-2151	A-4455-CZ 15 A(208)	22-15-4155	A-4455-AZ 15B(P909)
16	22-02-2165	A-4455-CZ 16 A(P909)			22-18-2161	A-4455-CZ 16 A(208)	22-15-4165	A-4455-AZ 16B(P909)
17	22-02-2175	A-4455-CZ 17 A(P909)			22-18-2171	A-4455-CZ 17 A(208)	22-15-4175	A-4455-AZ 17B(P909)
18	22-02-2185	A-4455-CZ 18 A(P909)	22-18-2183	A-4455-CZ 18 A(565)	22-18-2181	A-4455-CZ 18 A(208)	22-15-4185	A-4455-AZ 18B(P909)
19	22-02-2195	A-4455-CZ 19 A(P909)			22-18-2191	A-4455-CZ 19 A(208)	22-15-4195	A-4455-AZ 19B(P909)
20	22-02-2205	A-4455-CZ 20 A(P909)	22-18-2203	A-4455-CZ 20 A(565)	22-18-2201	A-4455-CZ 20 A(208)	22-15-4205	A-4455-AZ 20B(P909)
21							22-15-4215	A-4455-AZ 21B(P909)
22							22-15-4225	A-4455-AZ 22B(P909)
23							22-15-4235	A-4455-AZ 23B(P909)
24							22-15-4245	A-4455-AZ 24B(P909)
25							22-15-4255	A-4455-AZ 25B(P909)

THIS DRAWING CONTAINS INFORMATION THAT IS PROPRIETARY TO MOLEX ELECTRONIC TECHNOLOGIES, LLC AND SHOULD NOT BE USED WITHOUT WRITTEN PERMISSION											
DIMENSION UNITS MM/IN		SCALE 1:1		CURRENT REV DESC: REMOVED OBSOLETE PART NUMBER AS PER PCN#512128.				molex			
GENERAL TOLERANCES (UNLESS SPECIFIED)						EC NO: 716046		KK 100 PCB ASSY 4455 SERIES DWG			
4 PLACES ±		MM		INCH		DRWN: SANTHN					
3 PLACES ±		0.25		0.015		CHKD: GGA		PRODUCT CUSTOMER DRAWING			
2 PLACES ±		0.25		0.015		APPR: GGA		DOCUMENT NUMBER			
1 PLACE ±		0.36		±		INITIAL REVISION:		DOC TYPE DOC PART REVISION			
0 PLACES ±		±		±		DRWN: SAMIEC		SDA-4455			
ANGULAR TOL ±		0.5°		±		APPR: LENZ		PSD 001 D18			
DRAFT WHERE APPLICABLE MUST REMAIN WITHIN DIMENSIONS				THIRD ANGLE PROJECTION		DRAWING		SERIES		MATERIAL NUMBER	
				B-SIZE		4455		SEE CHART		GENERAL MARKET	
4 OF 15				4 OF 15		4 OF 15		4 OF 15		4 OF 15	

KK 100 PCB ASSY 2-25 CKT

4455 SERIES

Ckts	Assy Proc: RIGHT ANGLE		Assy Proc: RIGHT ANGLE		Assy Proc: BOTTOM ENTRY		Assy Proc: BOTTOM ENTRY	
		Hooks Cut:	NO	Hooks Cut:	NO	Hooks Cut:	NO	Hooks Cut:
	Housing No:	4455-N	Housing No:	4455-N	Housing No:	4455-N2	Housing No:	4455-N2
	Terminal No:	6516-4(565)	Terminal No:	6516-4(208)	Terminal No:	6516-3B(565)	Terminal No:	6516-3B(208)
	Dim C:	3.35 / .132	Dim C:	3.35 / .132	Dim C:	3.35 / .132	Dim C:	3.35 / .132
	Plating:	565	Plating:	208	Plating:	565	Plating:	208
	Packaging:	PK-44646-001	Packaging:	PK-44646-001	Packaging:	PK-44646-001	Packaging:	PK-44646-001
	Voids:	NONE	Voids:	NONE	Voids:	NONE	Voids:	NONE
	Material No	Engineer Number	Material No	Engineer Number	Material No	Engineer Number	Material No	Engineer Number
2	22-16-2024	A-4455-AZ02B(565)			22-17-2021	A-4455-BH02J(565)		
3	22-16-2034	A-4455-AZ 03 B(565)			22-17-2031	A-4455-BH 03 J(565)		
4	22-16-2044	A-4455-AZ 04 B(565)			22-17-2041	A-4455-BH 04 J(565)		
5	22-16-2054	A-4455-AZ 05 B(565)			22-17-2051	A-4455-BH 05 J(565)		
6	22-16-2064	A-4455-AZ 06 B(565)			22-17-2061	A-4455-BH 06 J(565)		
7	22-16-2074	A-4455-AZ 07 B(565)			22-17-2071	A-4455-BH 07 J(565)		
8	22-16-2084	A-4455-AZ 08 B(565)			22-17-2081	A-4455-BH 08 J(565)		
9	22-16-2094	A-4455-AZ 09 B(565)			22-17-2091	A-4455-BH 09 J(565)		
10	22-16-2104	A-4455-AZ 10 B(565)			22-17-2101	A-4455-BH 10 J(565)		
11	22-16-2114	A-4455-AZ 11 B(565)			22-17-2111	A-4455-BH 11 J(565)		
12	22-16-2124	A-4455-AZ 12 B(565)			22-17-2121	A-4455-BH 12 J(565)		
13	22-16-2134	A-4455-AZ 13 B(565)			22-17-2131	A-4455-BH 13 J(565)		
14	22-16-2144	A-4455-AZ 14 B(565)			22-17-2141	A-4455-BH 14 J(565)		
15	22-16-2154	A-4455-AZ 15 B(565)			22-17-2151	A-4455-BH 15 J(565)		
16	22-16-2164	A-4455-AZ 16 B(565)			22-17-2161	A-4455-BH 16 J(565)		
17	22-16-2174	A-4455-AZ 17 B(565)			22-17-2171	A-4455-BH 17 J(565)		
18	22-16-2184	A-4455-AZ 18 B(565)			22-17-2181	A-4455-BH 18 J(565)		
19	22-16-2194	A-4455-AZ 19 B(565)			22-17-2191	A-4455-BH 19 J(565)		
20	22-16-2204	A-4455-AZ 20 B(565)			22-17-2201	A-4455-BH 20 J(565)		
21	22-16-2214	A-4455-AZ 21 B(565)			22-17-2211	A-4455-BH 21 J(565)		
22	22-16-2224	A-4455-AZ 22 B(565)			22-17-2221	A-4455-BH 22 J(565)		
23	22-16-2234	A-4455-AZ 23 B(565)			22-17-2231	A-4455-BH 23 J(565)		
24	22-16-2244	A-4455-AZ 24 B(565)			22-17-2241	A-4455-BH 24 J(565)		
25					22-17-2251	A-4455-BH 25 J(565)		

THIS DRAWING CONTAINS INFORMATION THAT IS PROPRIETARY TO MOLEX ELECTRONIC TECHNOLOGIES, LLC AND SHOULD NOT BE USED WITHOUT WRITTEN PERMISSION											
DIMENSION UNITS		SCALE		CURRENT REV DESC: REMOVED OBSOLETE PART NUMBER AS PER PCN#512128.				molex			
MM/IN		1:1									
GENERAL TOLERANCES (UNLESS SPECIFIED)				EC NO: 716046 DRWN: SANTHN 2022/07/22 CHKD: GGA 2022/07/29 APPR: GGA 2022/07/29				PRODUCT CUSTOMER DRAWING			
4 PLACES ±		±									
3 PLACES ±		± 0.01									
2 PLACES ±		± 0.25 ± 0.015									
1 PLACE ±		± 0.36 ±									
0 PLACES ±		±		INITIAL REVISION:				DOCUMENT NUMBER			
ANGULAR TOL ±		± 0.5°		DRWN: SAMIEC 1984/05/10				SDA-4455			
DRAFT WHERE APPLICABLE MUST REMAIN WITHIN DIMENSIONS		THIRD ANGLE PROJECTION		DRAWING		SERIES		MATERIAL NUMBER		CUSTOMER	
				B-SIZE		4455		SEE CHART		GENERAL MARKET	
								PSD 001		D18	
								5 OF 15			

KK 100 PCB ASSY 2-25 CKT 4455 SERIES

Ckts	Assy Proc: TOP ENTRY		Assy Proc: TOP ENTRY		Assy Proc: TOP ENTRY		Assy Proc: RIGHT ANGLE	
	Material No	Engineer Number	Material No	Engineer Number	Material No	Engineer Number	Material No	Engineer Number
2			22-18-2022	A-4455-CZ02B(565)				
3			22-18-2032	A-4455-CZ 03 B(565)				
4			22-18-2042	A-4455-CZ 04 B(565)				
5			22-18-2052	A-4455-CZ 05 B(565)				
6			22-18-2062	A-4455-CZ 06 B(565)				
7			22-18-2072	A-4455-CZ 07 B(565)			22-15-2075	A-4455-AA07A(P909)
8			22-18-2082	A-4455-CZ 08 B(565)			22-15-2085	A-4455-AA 08A(P909)
9			22-18-2092	A-4455-CZ 09 B(565)			22-15-2095	A-4455-AA 09A(P909)
10			22-18-2102	A-4455-CZ 10 B(565)			22-15-2105	A-4455-AA 10A(P909)
11			22-18-2112	A-4455-CZ 11 B(565)			22-15-2115	A-4455-AA 11A(P909)
12			22-18-2122	A-4455-CZ 12 B(565)				
13			22-18-2132	A-4455-CZ 13 B(565)			22-15-2135	A-4455-AA 13A(P909)
14			22-18-2142	A-4455-CZ 14 B(565)			22-15-2145	A-4455-AA 14A(P909)
15			22-18-2152	A-4455-CZ 15 B(565)			22-15-2155	A-4455-AA 15A(P909)
16			22-18-2162	A-4455-CZ 16 B(565)			22-15-2165	A-4455-AA 16A(P909)
17			22-18-2172	A-4455-CZ 17 B(565)			22-15-2175	A-4455-AA 17A(P909)
18			22-18-2182	A-4455-CZ 18 B(565)				
19			22-18-2192	A-4455-CZ 19 B(565)			22-15-2195	A-4455-AA 19A(P909)
20			22-18-2202	A-4455-CZ 20 B(565)				
21			22-18-2212	A-4455-CZ 21 B(565)			22-15-2215	A-4455-AA 21A(P909)
22			22-18-2222	A-4455-CZ 22 B(565)			22-15-2225	A-4455-AA 22A(P909)
23			22-18-2232	A-4455-CZ 23 B(565)				
24			22-18-2242	A-4455-CZ 24 B(565)			22-15-2245	A-4455-AA 24A(P909)
25			22-18-2252	A-4455-CZ 25 B(565)			22-15-2255	A-4455-AA 25A(P909)

THIS DRAWING CONTAINS INFORMATION THAT IS PROPRIETARY TO MOLEX ELECTRONIC TECHNOLOGIES, LLC AND SHOULD NOT BE USED WITHOUT WRITTEN PERMISSION											
DIMENSION UNITS MM/IN		SCALE 1:1		CURRENT REV DESC: REMOVED OBSOLETE PART NUMBER AS PER PCN#512128.				molex			
GENERAL TOLERANCES (UNLESS SPECIFIED)						EC NO: 716046		KK 100 PCB ASSY 4455 SERIES DWG PRODUCT CUSTOMER DRAWING			
4 PLACES ±		MM		INCH		DRWN: SANTHN 2022/07/22					
3 PLACES ±		0.25		0.015		CHKD: GGA 2022/07/29					
2 PLACES ±		0.36		±		APPR: GGA 2022/07/29					
1 PLACE ±		0.5°		ANGULAR TOL ±		INITIAL REVISION:		DOCUMENT NUMBER		DOC TYPE DOC PART REVISION	
0 PLACES ±		THIRD ANGLE PROJECTION		DRAWING		SERIES		MATERIAL NUMBER		CUSTOMER	
DRAFT WHERE APPLICABLE MUST REMAIN WITHIN DIMENSIONS		B-SIZE		4455		SEE CHART		GENERAL MARKET		SHEET NUMBER 6 OF 15	

KK 100 PCB ASSY 2-25 CKT

4455 SERIES

Ckts	Assy Proc: RIGHT ANGLE		Assy Proc: RIGHT ANGLE		Assy Proc: RIGHT ANGLE		Assy Proc: RIGHT ANGLE	
	Material No	Engineer Number	Material No	Engineer Number	Material No	Engineer Number	Material No	Engineer Number
2					22-15-4024	A-4455-AB02A(P909)		
3					22-15-4034	A-4455-AB 03A(P909)		
4					22-15-4044	A-4455-AB 04A(P909)		
5					22-15-4054	A-4455-AB 05A(P909)		
6			50-34-8518	A-4455-AB 06 A(228)	22-15-4064	A-4455-AB 06A(P909)		
7					22-15-4074	A-4455-AB 07A(P909)		
8					22-15-4084	A-4455-AB 08A(P909)		
9	22-16-2096	A-4455-AA 09 A(208)			22-15-4094	A-4455-AB 09A(P909)		
10							22-15-2102	A-4455-AE 10A(P909)
11					22-15-4114	A-4455-AB 11A(P909)		
12					22-15-4124	A-4455-AB 12A(P909)		
13					22-15-4134	A-4455-AB 13A(P909)		
14					22-15-4144	A-4455-AB 14A(P909)		
15					22-15-4154	A-4455-AB 15A(P909)		
16					22-15-4164	A-4455-AB 16A(P909)		
17					22-15-4174	A-4455-AB 17A(P909)		
18	22-16-2186	A-4455-AA 18 A(208)						
19	22-16-2196	A-4455-AA 19 A(208)			22-15-4194	A-4455-AB 19A(P909)		
20	22-16-2206	A-4455-AA 20 A(208)			22-15-4204	A-4455-AB 20A(P909)		
21	22-16-2216	A-4455-AA 21 A(208)			22-15-4214	A-4455-AB 21A(P909)		
22	22-16-2226	A-4455-AA 22 A(208)			22-15-4224	A-4455-AB 22A(P909)		
23	22-16-2236	A-4455-AA 23 A(208)			22-15-4234	A-4455-AB 23A(P909)		
24					22-15-4244	A-4455-AB 24A(P909)		
25					22-15-4254	A-4455-AB 25A(P909)	22-15-2252	A-4455-AE 25A(P909)

THIS DRAWING CONTAINS INFORMATION THAT IS PROPRIETARY TO MOLEX ELECTRONIC TECHNOLOGIES, LLC AND SHOULD NOT BE USED WITHOUT WRITTEN PERMISSION																	
DIMENSION UNITS MM/IN		SCALE 1:1		CURRENT REV DESC: REMOVED OBSOLETE PART NUMBER AS PER PCN#512128.				molex									
GENERAL TOLERANCES (UNLESS SPECIFIED)				EC NO: 716046 DRWN: SANTHN CHKD: GGA APPR: GGA INITIAL REVISION: DRWN: SAMIEC APPR: LENZ				KK 100 PCB ASSY 4455 SERIES DWG									
4 PLACES ±		±						2022/07/22				PRODUCT CUSTOMER DRAWING					
3 PLACES ±		± 0.01						2022/07/29				DOCUMENT NUMBER					
2 PLACES ± 0.25		± 0.015						2022/07/29				SDA-4455		DOC TYPE		DOC PART	
1 PLACE ± 0.36		±						1984/05/10				PSD		001		D18	
0 PLACES ±		±		1984/05/10				SERIES		MATERIAL NUMBER		CUSTOMER					
ANGULAR TOL ± 0.5°				THIRD ANGLE PROJECTION		DRAWING		B-SIZE		4455		SEE CHART		GENERAL MARKET		SHEET NUMBER	
DRAFT WHERE APPLICABLE MUST REMAIN WITHIN DIMENSIONS						7 OF 15											

KK 100 PCB ASSY 2-25 CKT 4455 SERIES

Ckts	Assy Proc: RIGHT ANGLE		Assy Proc: RIGHT ANGLE		Assy Proc: RIGHT ANGLE		Assy Proc: RIGHT ANGLE	
	Material No	Engineer Number	Material No	Engineer Number	Material No	Engineer Number	Material No	Engineer Number
2	22-15-4022	A-4455-AR02A(P909)			22-17-5023	A-4455-AZ02B(228)		
3	22-15-4032	A-4455-AR 03 A(P909)			22-17-5033	A-4455-AZ 03 B(228)		
4	22-15-4042	A-4455-AR 04 A(P909)			22-17-5043	A-4455-AZ 04 B(228)		
5	22-15-4052	A-4455-AR 05 A(P909)						
6	22-15-4062	A-4455-AR 06 A(P909)			22-17-5063	A-4455-AZ 06 B(228)		
7	22-15-4072	A-4455-AR 07 A(P909)			22-17-5073	A-4455-AZ 07 B(228)		
8	22-15-4082	A-4455-AR 08 A(P909)			22-17-5083	A-4455-AZ 08 B(228)		
9	22-15-4092	A-4455-AR 09 A(P909)			22-17-5093	A-4455-AZ 09 B(228)		
10	22-15-4102	A-4455-AR 10 A(P909)			22-17-5103	A-4455-AZ 10 B(228)		
11	22-15-4112	A-4455-AR 11 A(P909)			22-17-5113	A-4455-AZ 11 B(228)		
12	22-15-4122	A-4455-AR 12 A(P909)			22-17-5123	A-4455-AZ 12 B(228)		
13	22-15-4132	A-4455-AR 13 A(P909)			22-17-5133	A-4455-AZ 13 B(228)		
14	22-15-4142	A-4455-AR 14 A(P909)			22-17-5143	A-4455-AZ 14 B(228)		
15	22-15-4152	A-4455-AR 15 A(P909)			22-17-5153	A-4455-AZ 15 B(228)		
16	22-15-4162	A-4455-AR 16 A(P909)			22-17-5163	A-4455-AZ 16 B(228)		
17	22-15-4172	A-4455-AR 17 A(P909)			22-17-5173	A-4455-AZ 17 B(228)		
18	22-15-4182	A-4455-AR 18 A(P909)			22-17-5183	A-4455-AZ 18 B(228)		
19	22-15-4192	A-4455-AR 19 A(P909)			22-17-5193	A-4455-AZ 19 B(228)		
20	22-15-4202	A-4455-AR 20 A(P909)	22-17-5201	A-4455-AZ 20 A(228)	22-17-5203	A-4455-AZ 20 B(228)		
21	22-15-4212	A-4455-AR 21 A(P909)			22-17-5213	A-4455-AZ 21 B(228)		
22	22-15-4222	A-4455-AR 22 A(P909)			22-17-5223	A-4455-AZ 22 B(228)		
23	22-15-4232	A-4455-AR 23 A(P909)			22-17-5233	A-4455-AZ 23 B(228)		
24	22-15-4242	A-4455-AR 24 A(P909)			22-17-5243	A-4455-AZ 24 B(228)		
25	22-15-4252	A-4455-AR 25 A(P909)			22-17-5253	A-4455-AZ 25 B(228)		

THIS DRAWING CONTAINS INFORMATION THAT IS PROPRIETARY TO MOLEX ELECTRONIC TECHNOLOGIES, LLC AND SHOULD NOT BE USED WITHOUT WRITTEN PERMISSION											
DIMENSION UNITS MM/IN		SCALE 1:1		CURRENT REV DESC: REMOVED OBSOLETE PART NUMBER AS PER PCN#512128.				molex			
GENERAL TOLERANCES (UNLESS SPECIFIED)						EC NO: 716046		KK 100 PCB ASSY 4455 SERIES DWG			
4 PLACES ±		MM		INCH		DRWN: SANTHN 2022/07/22					
3 PLACES ±		0.25		0.015		CHKD: GGA 2022/07/29					
2 PLACES ±		0.36		±		APPR: GGA 2022/07/29					
1 PLACE ±		0.5		°		INITIAL REVISION:					
ANGULAR TOL ±		0.5		°		DRWN: SAMIEC 1984/05/10		DOCUMENT NUMBER			
DRAFT WHERE APPLICABLE MUST REMAIN WITHIN DIMENSIONS		THIRD ANGLE PROJECTION		DRAWING		SERIES		MATERIAL NUMBER		CUSTOMER	
				B-SIZE		4455		SEE CHART		GENERAL MARKET	
						1984/05/10		SDA-4455		PSD 001 D18	
								8 OF 15			

KK 100 PCB ASSY 2-25 CKT 4455 SERIES

Ckts	Assy Proc: TOP ENTRY		Assy Proc: TOP ENTRY		Assy Proc: TOP ENTRY		Assy Proc: TOP ENTRY	
		Hooks Cut:	YES	Hooks Cut:	YES	Hooks Cut:	YES	Hooks Cut:
	Housing No:	4455-NR	Housing No:	4455-N	Housing No:	4455-N	Housing No:	4455-BN
	Terminal No:	4316-4(208)	Terminal No:	4316-4(565)	Terminal No:	4316-4(P909)	Terminal No:	4316-4(P909)
	Dim C:	3.35 / .132	Dim C:	3.35 / .132	Dim C:	3.35 / .132	Dim C:	3.35 / .132
	Plating:	208	Plating:	565	Plating:	P909	Plating:	P909
	Packaging:	PK-44646-003	Packaging:	PK-44646-003	Packaging:	PK-44646-003	Packaging:	PK-44646-002
	Voids:	NO	Voids:	NO	Voids:	NO	Voids:	NO
Material No	Engineer Number	Material No	Engineer Number	Material No	Engineer Number	Material No	Engineer Number	
2		22-18-2026	A-4455-CY02A(565)	22-02-7023	A-4455-CY02A(P909)	22-15-4028	A-4455-CB02A(P909)	
3		22-18-2036	A-4455-CY 03 A(565)	22-02-7033	A-4455-CY 03A(P909)	22-15-4038	A-4455-CB 03A(P909)	
4		22-18-2046	A-4455-CY 04 A(565)	22-02-7043	A-4455-CY 04A(P909)	22-15-4048	A-4455-CB 04A(P909)	
5	22-18-2057	A-4455-CP 05 A(208)		22-02-7053	A-4455-CY 05A(P909)	22-15-4058	A-4455-CB 05A(P909)	
6			22-18-2066	A-4455-CY 06 A(565)	22-02-7063	A-4455-CY 06A(P909)	22-15-4068	A-4455-CB 06A(P909)
7					22-02-7073	A-4455-CY 07A(P909)	22-15-4078	A-4455-CB 07A(P909)
8					22-02-7083	A-4455-CY 08A(P909)	22-15-4088	A-4455-CB 08A(P909)
9					22-02-7093	A-4455-CY 09A(P909)	22-15-4098	A-4455-CB 09A(P909)
10					22-02-7103	A-4455-CY 10A(P909)	22-15-4108	A-4455-CB 10A(P909)
11					22-02-7113	A-4455-CY 11A(P909)	22-15-4118	A-4455-CB 11A(P909)
12			22-18-2126	A-4455-CY 12 A(565)	22-02-7123	A-4455-CY 12A(P909)	22-15-4128	A-4455-CB 12A(P909)
13					22-02-7133	A-4455-CY 13A(P909)	22-15-4138	A-4455-CB 13A(P909)
14			22-18-2146	A-4455-CY 14 A(565)	22-02-7143	A-4455-CY 14A(P909)	22-15-4148	A-4455-CB 14A(P909)
15			22-18-2156	A-4455-CY 15 A(565)	22-02-7153	A-4455-CY 15A(P909)	22-15-4158	A-4455-CB 15A(P909)
16			22-18-2166	A-4455-CY 16 A(565)	22-02-7163	A-4455-CY 16A(P909)	22-15-4168	A-4455-CB 16A(P909)
17			22-18-2176	A-4455-CY 17 A(565)	22-02-7173	A-4455-CY 17A(P909)	22-15-4178	A-4455-CB 17A(P909)
18			22-18-2186	A-4455-CY 18 A(565)	22-02-7183	A-4455-CY 18A(P909)		
19			22-18-2196	A-4455-CY 19 A(565)	22-02-7193	A-4455-CY 19A(P909)	22-15-4198	A-4455-CB 19A(P909)
20			22-18-2206	A-4455-CY 20 A(565)	22-02-7203	A-4455-CY 20A(P909)	22-15-4208	A-4455-CB 20A(P909)
21			22-18-2216	A-4455-CY 21 A(565)	22-02-7213	A-4455-CY 21A(P909)	22-15-4218	A-4455-CB 21A(P909)
22			22-18-2226	A-4455-CY 22 A(565)	22-02-7223	A-4455-CY 22A(P909)	22-15-4228	A-4455-CB 22A(P909)
23			22-18-2236	A-4455-CY 23 A(565)	22-02-7233	A-4455-CY 23A(P909)	22-15-4238	A-4455-CB 23A(P909)
24			22-18-2246	A-4455-CY 24 A(565)			22-15-4248	A-4455-CB 24A(P909)
25			22-18-2256	A-4455-CY 25 A(565)			22-15-4258	A-4455-CB 25A(P909)

THIS DRAWING CONTAINS INFORMATION THAT IS PROPRIETARY TO MOLEX ELECTRONIC TECHNOLOGIES, LLC AND SHOULD NOT BE USED WITHOUT WRITTEN PERMISSION										
DIMENSION UNITS	SCALE	CURRENT REV DESC: REMOVED OBSOLETE PART NUMBER AS PER PCN#512128.			molex					
MM/IN	1:1				KK 100 PCB ASSY 4455 SERIES DWG					
GENERAL TOLERANCES (UNLESS SPECIFIED)					PRODUCT CUSTOMER DRAWING					
	MM	INCH								
4 PLACES	±									
3 PLACES	±	0.01								
2 PLACES	±	0.25 ± 0.015								
1 PLACE	±	0.36								
0 PLACES	±									
ANGULAR TOL	±	0.5°								
DRAFT WHERE APPLICABLE MUST REMAIN WITHIN DIMENSIONS		THIRD ANGLE PROJECTION	DRAWING	SERIES	MATERIAL NUMBER	CUSTOMER	DOCUMENT NUMBER	DOC TYPE	DOC PART	REVISION
			B-SIZE	4455	SEE CHART	GENERAL MARKET	SDA-4455	PSD	001	D18
EC NO: 716046		DRWN: SANTHN			2022/07/22					
CHKD: GGA		APPR: GGA			2022/07/29					
INITIAL REVISION:		DRWN: SAMIEC			1984/05/10					
APPR: LENZ		1984/05/10								
SHEET NUMBER		10 OF 15								

KK 100 PCB ASSY 2-25 CKT 4455 SERIES

Ckts	Assy Proc: TOP ENTRY		Assy Proc: TOP ENTRY		Assy Proc: TOP ENTRY		Assy Proc: TOP ENTRY	
	Material No	Engineer Number	Material No	Engineer Number	Material No	Engineer Number	Material No	Engineer Number
2	22-65-3020	A-4455-CR02A(P909)			22-18-7023	A-4455-CY02A(208)	22-18-7021	A-4455-CY02B(228)
3	22-65-3030	A-4455-CR 03A(P909)			22-18-7033	A-4455-CY 03 A(208)	22-18-7031 38-00-1478	A-4455-CY 03 B(228)
4	22-65-3040	A-4455-CR 04A(P909)			22-18-7043	A-4455-CY 04 A(208)	22-18-7041	A-4455-CY 04 B(228)
5	22-65-3050	A-4455-CR 05A(P909)			22-18-7053	A-4455-CY 05 A(208)	22-18-7051	A-4455-CY 05 B(228)
6	22-65-3060	A-4455-CR 06A(P909)			22-18-7063	A-4455-CY 06 A(208)	22-18-7061	A-4455-CY 06 B(228)
7	22-65-3070	A-4455-CR 07A(P909)			22-18-7073	A-4455-CY 07 A(208)	22-18-7071	A-4455-CY 07 B(228)
8	22-65-3080	A-4455-CR 08A(P909)			22-18-7083	A-4455-CY 08 A(208)	22-18-7081	A-4455-CY 08 B(228)
9	22-65-3090	A-4455-CR 09A(P909)			22-18-7093	A-4455-CY 09 A(208)	22-18-7091	A-4455-CY 09 B(228)
10	22-65-3100	A-4455-CR 10A(P909)			22-18-7103	A-4455-CY 10 A(208)	22-18-7101	A-4455-CY 10 B(228)
11	22-65-3110	A-4455-CR 11A(P909)			22-18-7113	A-4455-CY 11 A(208)	22-18-7111	A-4455-CY 11 B(228)
12	22-65-3120	A-4455-CR 12A(P909)	22-18-2124	A-4455-CZ 12 B(228)	22-18-7123	A-4455-CY 12 A(208)	22-18-7121	A-4455-CY 12 B(228)
13	22-65-3130	A-4455-CR 13A(P909)			22-18-7133	A-4455-CY 13 A(208)	22-18-7131	A-4455-CY 13 B(228)
14	22-65-3140	A-4455-CR 14A(P909)			22-18-7143	A-4455-CY 14 A(208)	22-18-7141	A-4455-CY 14 B(228)
15	22-65-3150	A-4455-CR 15A(P909)			22-18-7153	A-4455-CY 15 A(208)	22-18-7151	A-4455-CY 15 B(228)
16	22-65-3160	A-4455-CR 16A(P909)	22-18-2164	A-4455-CZ 16 B(228)	22-18-7163	A-4455-CY 16 A(208)	22-18-7161	A-4455-CY 16 B(228)
17	22-65-3170	A-4455-CR 17A(P909)			22-18-7173	A-4455-CY 17 A(208)	22-18-7171	A-4455-CY 17 B(228)
18	22-65-3180	A-4455-CR 18A(P909)			22-18-7183	A-4455-CY 18 A(208)	22-18-7181	A-4455-CY 18 B(228)
19	22-65-3190	A-4455-CR 19A(P909)	22-18-2194	A-4455-CZ 19 B(228)	22-18-7193	A-4455-CY 19 A(208)	22-18-7191	A-4455-CY 19 B(228)
20	22-65-3200	A-4455-CR 20A(P909)			22-18-7203	A-4455-CY 20 A(208)	22-18-7201	A-4455-CY 20 B(228)
21	22-65-3210	A-4455-CR 21A(P909)			22-18-7213	A-4455-CY 21 A(208)	22-18-7211	A-4455-CY 21 B(228)
22	22-65-3220	A-4455-CR 22A(P909)			22-18-7223	A-4455-CY 22 A(208)	22-18-7221	A-4455-CY 22 B(228)
23	22-65-3230	A-4455-CR 23A(P909)			22-18-7233	A-4455-CY 23 A(208)	22-18-7231	A-4455-CY 23 B(228)
24	22-65-3240	A-4455-CR 24A(P909)			22-18-7243	A-4455-CY 24 A(208)		
25	22-65-3250	A-4455-CR 25A(P909)			22-18-7253	A-4455-CY 25 A(208)	22-18-7251	A-4455-CY 25 B(228)

THIS DRAWING CONTAINS INFORMATION THAT IS PROPRIETARY TO MOLEX ELECTRONIC TECHNOLOGIES, LLC AND SHOULD NOT BE USED WITHOUT WRITTEN PERMISSION									
DIMENSION UNITS MM/IN	SCALE 1:1	CURRENT REV DESC: REMOVED OBSOLETE PART NUMBER AS PER PCN#512128.			molex				
GENERAL TOLERANCES (UNLESS SPECIFIED)		EC NO: 716046			KK 100 PCB ASSY 4455 SERIES DWG				
4 PLACES ± 0.25 ± 0.015		DRWN: SANTHN 2022/07/22							
3 PLACES ± 0.25 ± 0.015		CHKD: GGA 2022/07/29			PRODUCT CUSTOMER DRAWING				
2 PLACES ± 0.25 ± 0.015		APPR: GGA 2022/07/29			DOCUMENT NUMBER		DOC TYPE	DOC PART	REVISION
1 PLACE ± 0.36 ±		INITIAL REVISION:			SDA-4455		PSD	001	D18
0 PLACES ±		DRWN: SAMIEC 1984/05/10							
ANGULAR TOL ± 0.5°		APPR: LENZ 1984/05/10			MATERIAL NUMBER		CUSTOMER		SHEET NUMBER
DRAFT WHERE APPLICABLE MUST REMAIN WITHIN DIMENSIONS		THIRD ANGLE PROJECTION		DRAWING	SERIES	SEE CHART		GENERAL MARKET	
				B-SIZE	4455			11 OF 15	

KK 100 PCB ASSY 2-25 CKT 4455 SERIES

Ckts	Assy Proc: RIGHT ANGLE		Assy Proc: BOTTOM ENTRY		Assy Proc: RIGHT ANGLE		Assy Proc: RIGHT ANGLE	
	Material No	Engineer Number	Material No	Engineer Number	Material No	Engineer Number	Material No	Engineer Number
2	38-00-1332	A-4455-AZ02C(P909)	38-00-1392	A-4455-BH02F(P909)				
3	38-00-1333	A-4455-AZ03C(P909)	38-00-1393	A-4455-BH03F(P909)				
4	38-00-1334	A-4455-AZ04C(P909)	38-00-1394	A-4455-BH04F(P909)				
5	38-00-1335	A-4455-AZ05C(P909)	38-00-1395	A-4455-BH05F(P909)				
6	38-00-1336	A-4455-AZ06C(P909)	38-00-1396	A-4455-BH06F(P909)				
7	38-00-1337	A-4455-AZ07C(P909)	38-00-1397	A-4455-BH07F(P909)	22-14-2079	A-4455-AA07B(P909)	22-14-2077	A-4455-AA07A(565)
8	38-00-1338	A-4455-AZ08C(P909)	38-00-1398	A-4455-BH08F(P909)	22-14-2089	A-4455-AA 08 B(P909)	22-14-2087	A-4455-AA 08 A(565)
9	38-00-1339	A-4455-AZ09C(P909)	38-00-1399	A-4455-BH09F(P909)	22-14-2099	A-4455-AA 09 B(P909)	22-14-2097	A-4455-AA 09 A(565)
10	38-00-1340	A-4455-AZ10C(P909)	38-00-1400	A-4455-BH10F(P909)	22-14-2109	A-4455-AA 10 B(P909)	22-14-2107	A-4455-AA 10 A(565)
11	38-00-1341	A-4455-AZ11C(P909)	38-00-1401	A-4455-BH11F(P909)	22-14-2119	A-4455-AA 11 B(P909)	22-14-2117	A-4455-AA 11 A(565)
12	38-00-1342	A-4455-AZ12C(P909)	38-00-1402	A-4455-BH12F(P909)	22-14-2129	A-4455-AA 12 B(P909)	22-14-2127	A-4455-AA 12 A(565)
13	38-00-1343	A-4455-AZ13C(P909)	38-00-1403	A-4455-BH13F(P909)	22-14-2139	A-4455-AA 13 B(P909)	22-14-2137	A-4455-AA 13 A(565)
14	38-00-1344	A-4455-AZ14C(P909)	38-00-1404	A-4455-BH14F(P909)	22-14-2149	A-4455-AA 14 B(P909)	22-14-2147	A-4455-AA 14 A(565)
15	38-00-1345	A-4455-AZ15C(P909)	38-00-1405	A-4455-BH15F(P909)	22-14-2159	A-4455-AA 15 B(P909)	22-14-2157	A-4455-AA 15 A(565)
16	38-00-1346	A-4455-AZ16C(P909)	38-00-1406	A-4455-BH16F(P909)	22-14-2169	A-4455-AA 16 B(P909)	22-14-2167	A-4455-AA 16 A(565)
17	38-00-1347	A-4455-AZ17C(P909)	38-00-1407	A-4455-BH17F(P909)	22-14-2179	A-4455-AA 17 B(P909)	22-14-2177	A-4455-AA 17 A(565)
18	38-00-1348	A-4455-AZ18C(P909)	38-00-1408	A-4455-BH18F(P909)	22-14-2189	A-4455-AA 18 B(P909)	22-14-2187	A-4455-AA 18 A(565)
19	38-00-1349	A-4455-AZ19C(P909)	38-00-1409	A-4455-BH19F(P909)	22-14-2199	A-4455-AA 19 B(P909)	22-14-2197	A-4455-AA 19 A(565)
20	38-00-1350	A-4455-AZ20C(P909)	38-00-1410	A-4455-BH20F(P909)	22-14-2209	A-4455-AA 20 B(P909)	22-14-2207	A-4455-AA 20 A(565)
21					22-14-2219	A-4455-AA 21 B(P909)	22-14-2217	A-4455-AA 21 A(565)
22					22-14-2229	A-4455-AA 22 B(P909)	22-14-2227	A-4455-AA 22 A(565)
23					22-14-2239	A-4455-AA 23 B(P909)	22-14-2237	A-4455-AA 23 A(565)
24					22-14-2249	A-4455-AA 24 B(P909)	22-14-2247	A-4455-AA 24 A(565)
25					22-14-2259	A-4455-AA 25 B(P909)	22-14-2257	A-4455-AA 25 A(565)

THIS DRAWING CONTAINS INFORMATION THAT IS PROPRIETARY TO MOLEX ELECTRONIC TECHNOLOGIES, LLC AND SHOULD NOT BE USED WITHOUT WRITTEN PERMISSION									
DIMENSION UNITS MM/IN	SCALE 1:1	CURRENT REV DESC: REMOVED OBSOLETE PART NUMBER AS PER PCN#512128.			molex				
GENERAL TOLERANCES (UNLESS SPECIFIED)		EC NO: 716046 DRWN: SANTHN CHKD: GGA APPR: GGA			KK 100 PCB ASSY 4455 SERIES DWG				
4 PLACES ±	3 PLACES ±	2 PLACES ±	1 PLACE ±	0 PLACES ±	INITIAL REVISION: DRWN: SAMIEC APPR: LENZ			PRODUCT CUSTOMER DRAWING	
ANGULAR TOL ± 0.5°	THIRD ANGLE PROJECTION			DRAWING	SERIES	MATERIAL NUMBER	CUSTOMER	DOCUMENT NUMBER	DOC TYPE DOC PART REVISION
DRAFT WHERE APPLICABLE MUST REMAIN WITHIN DIMENSIONS				B-SIZE	4455	SEE CHART	GENERAL MARKET	SDA-4455	PSD 001 D18
DOCUMENT STATUS		P1	RELEASE DATE	2022/07/29 12:32:02		SHEET NUMBER		12 OF 15	

KK 100 PCB ASSY 2-25 CKT

4455 SERIES

Ckts	Assy Proc: RIGHT ANGLE		Assy Proc: RIGHT ANGLE		Assy Proc: TOP ENTRY		Assy Proc: TOP ENTRY	
	Material No	Engineer Number	Material No	Engineer Number	Material No	Engineer Number	Material No	Engineer Number
2			22-16-3028	A-4455-AB02A(565)	38-00-1422	A-4455-CZ02C(P909)		
3			22-16-3038	A-4455-AB 03 A(565)	38-00-1423	A-4455-CZ03C(P909)		
4			22-16-3048	A-4455-AB 04 A(565)	38-00-1424	A-4455-CZ04C(P909)		
5			22-16-3058	A-4455-AB 05 A(565)	38-00-1425	A-4455-CZ05C(P909)		
6			22-16-3068	A-4455-AB 06 A(565)	38-00-1426	A-4455-CZ06C(P909)	22-02-3068	A-4455-CW06A(P909)-2
7	22-14-3617	A-4455-AA07T(P909)	22-16-3078	A-4455-AB 07 A(565)	38-00-1427	A-4455-CZ07C(P909)	50-29-0004	A-4455-CW07A(P909)-2
8	22-14-3618	A-4455-AA 08 T(P909)	22-16-3088	A-4455-AB 08 A(565)	38-00-1428	A-4455-CZ08C(P909)		
9	22-14-3619	A-4455-AA 09 T(P909)	22-16-3098	A-4455-AB 09 A(565)	38-00-1429	A-4455-CZ09C(P909)		
10	22-14-3711	A-4455-AA 10 T(P909)	22-16-3108	A-4455-AB 10 A(565)	38-00-1430	A-4455-CZ10C(P909)		
11	22-14-3712	A-4455-AA 11 T(P909)	22-16-3118	A-4455-AB 11 A(565)	38-00-1431	A-4455-CZ11C(P909)		
12	22-14-3713	A-4455-AA 12 T(P909)	22-16-3128	A-4455-AB 12 A(565)	38-00-1432	A-4455-CZ12C(P909)		
13	22-14-3714	A-4455-AA 13 T(P909)	22-16-3138	A-4455-AB 13 A(565)	38-00-1433	A-4455-CZ13C(P909)		
14	22-14-3715	A-4455-AA 14 T(P909)	22-16-3148	A-4455-AB 14 A(565)	38-00-1434	A-4455-CZ14C(P909)		
15	22-14-3716	A-4455-AA 15 T(P909)	22-16-3158	A-4455-AB 15 A(565)	38-00-1435	A-4455-CZ15C(P909)		
16	22-14-3717	A-4455-AA 16 T(P909)	22-16-3168	A-4455-AB 16 A(565)	38-00-1436	A-4455-CZ16C(P909)		
17	22-14-3718	A-4455-AA 17 T(P909)	22-16-3178	A-4455-AB 17 A(565)	38-00-1437	A-4455-CZ17C(P909)		
18	22-14-3719	A-4455-AA 18 T(P909)	22-16-3188	A-4455-AB 18 A(565)	38-00-1438	A-4455-CZ18C(P909)		
19	22-14-3811	A-4455-AA 19 T(P909)	22-16-3198	A-4455-AB 19 A(565)	38-00-1439	A-4455-CZ19C(P909)		
20	22-14-3812	A-4455-AA 20 T(P909)	22-16-3208	A-4455-AB 20 A(565)	38-00-1440	A-4455-CZ20C(P909)		
21	22-14-3813	A-4455-AA 21 T(P909)	22-16-3218	A-4455-AB 21 A(565)				
22	22-14-3814	A-4455-AA 22 T(P909)	22-16-3228	A-4455-AB 22 A(565)				
23	22-14-3815	A-4455-AA 23 T(P909)	22-16-3238	A-4455-AB 23 A(565)				
24	22-14-3816	A-4455-AA 24 T(P909)	22-16-3248	A-4455-AB 24 A(565)				
25			22-16-3258	A-4455-AB 25 A(565)				

THIS DRAWING CONTAINS INFORMATION THAT IS PROPRIETARY TO MOLEX ELECTRONIC TECHNOLOGIES, LLC AND SHOULD NOT BE USED WITHOUT WRITTEN PERMISSION															
DIMENSION UNITS MM/IN		SCALE 1:1		CURRENT REV DESC: REMOVED OBSOLETE PART NUMBER AS PER PCN#512128.				molex							
GENERAL TOLERANCES (UNLESS SPECIFIED)				EC NO: 716046 DRWN: SANTHN 2022/07/22 CHKD: GGA 2022/07/29 APPR: GGA 2022/07/29 INITIAL REVISION: DRWN: SAMIEC 1984/05/10 APPR: LENZ 1984/05/10				KK 100 PCB ASSY 4455 SERIES DWG							
								PRODUCT CUSTOMER DRAWING							
								DOCUMENT NUMBER		DOC TYPE		DOC PART		REVISION	
								SDA-4455		PSD		001		D18	
								MATERIAL NUMBER		CUSTOMER		SHEET NUMBER			
DRAFT WHERE APPLICABLE MUST REMAIN WITHIN DIMENSIONS				THIRD ANGLE PROJECTION		DRAWING		SERIES		SEE CHART					
						B-SIZE		4455		GENERAL MARKET					
										13 OF 15					

KK 100 PCB ASSY 2-25 CKT 4455 SERIES

Ckts	Assy Proc: TOP ENTRY		Assy Proc: TOP ENTRY		Assy Proc: BOTTOM ENTRY		Assy Proc: BOTTOM ENTRY	
	Material No	Engineer Number	Material No	Engineer Number	Material No	Engineer Number	Material No	Engineer Number
2								
3								
4								
5	50-29-1553	A-4455-CY 05B(P909)						
6	50-29-1554	A-4455-CY 06B(P909)	22-15-5065	A-4455-CY06A(P909)-2				
7								
8								
9								
10								
11					50-36-1881	A-4455-BH11D(P909)-10		
12								
13							26-01-3099	A-4455-BH13D(208)-51
14								
15								
16								
17								
18								
19								
20								
21								
22								
23								
24								
25								

THIS DRAWING CONTAINS INFORMATION THAT IS PROPRIETARY TO MOLEX ELECTRONIC TECHNOLOGIES, LLC AND SHOULD NOT BE USED WITHOUT WRITTEN PERMISSION													
DIMENSION UNITS	SCALE	CURRENT REV DESC: REMOVED OBSOLETE PART NUMBER AS PER PCN#512128.			molex								
MM/IN	1:1												
GENERAL TOLERANCES (UNLESS SPECIFIED)		EC NO: 716046 DRWN: SANTHN 2022/07/22 CHKD: GGA 2022/07/29 APPR: GGA 2022/07/29			KK 100 PCB ASSY 4455 SERIES DWG								
					PRODUCT CUSTOMER DRAWING								
4 PLACES	± .125				INITIAL REVISION: DRWN: SAMIEC 1984/05/10 APPR: LENZ 1984/05/10					DOCUMENT NUMBER	DOC TYPE	DOC PART	REVISION
3 PLACES	± .025									SDA-4455	PSD	001	D18
2 PLACES	± 0.25									MATERIAL NUMBER CUSTOMER SHEET NUMBER SEE CHART GENERAL MARKET 14 OF 15			
1 PLACE	± 0.36												
0 PLACES	± .015	THIRD ANGLE PROJECTION					DRAWING SERIES B-SIZE 4455						
ANGULAR TOL ± 0.5°													
DRAFT WHERE APPLICABLE MUST REMAIN WITHIN DIMENSIONS		THIRD ANGLE PROJECTION				DRAWING SERIES B-SIZE 4455							

KK 100 PCB ASSY 2-25 CKT 4455 SERIES

Ckts	Material No	Engineer Number	Material No	Engineer Number	Material No	Engineer Number	Material No	Engineer Number
2								
3			46999-0585	A-4455-CG03A(P909)			22-02-2031	A-4455-CY 03A(P909)
4			46999-0583	A-4455-CG04A(P909)				
5								
6			46999-0584	A-4455-CG06A(P909)				
7								
8					46999-0599	A-4455-CP 08A(P909)		
9								
10								
11								
12								
13								
14			46999-0586	A-4455-CG14A(P909)				
15								
16								
17	46999-0582	A-4455-AB17A(P909)-51						
18								
19								
20								
21								
22								
23								
24								
25								

THIS DRAWING CONTAINS INFORMATION THAT IS PROPRIETARY TO MOLEX ELECTRONIC TECHNOLOGIES, LLC AND SHOULD NOT BE USED WITHOUT WRITTEN PERMISSION															
DIMENSION UNITS MM/IN		SCALE 1:1		CURRENT REV DESC: REMOVED OBSOLETE PART NUMBER AS PER PCN#512128.				molex							
GENERAL TOLERANCES (UNLESS SPECIFIED)				EC NO: 716046 DRWN: SANTHN 2022/07/22 CHKD: GGA 2022/07/29 APPR: GGA 2022/07/29				KK 100 PCB ASSY 4455 SERIES DWG							
4 PLACES ±		±						PRODUCT CUSTOMER DRAWING							
3 PLACES ±		± 0.01						DOCUMENT NUMBER				DOC TYPE	DOC PART	REVISION	
2 PLACES ± 0.25		± 0.015						INITIAL REVISION:				SDA-4455	PSD	001	D18
1 PLACE ± 0.36		±						DRWN: SAMIEC 1984/05/10 APPR: LENZ 1984/05/10							
0 PLACES ±		±		ANGULAR TOL ± 0.5°				MATERIAL NUMBER		CUSTOMER		SHEET NUMBER			
DRAFT WHERE APPLICABLE MUST REMAIN WITHIN DIMENSIONS				THIRD ANGLE PROJECTION		DRAWING		SERIES		SEE CHART		GENERAL MARKET	15 OF 15		
						B-SIZE		4455							