

**ENERGIZER EN91**

**AA**



**Specifications**

**NOT INTENDED FOR RETAIL TRADE**

<b>Classification:</b>	Alkaline
<b>Chemical System:</b>	Zinc-Manganese Dioxide (Zn/MnO <sub>2</sub> ) No added mercury or cadmium
<b>Designation:</b>	ANSI-15A, IEC-LR6
<b>Nominal Voltage:</b>	1.5 volts
<b>Nominal IR:</b>	150 to 300 milliohms (fresh)
<b>Operating Temp:</b>	-18°C to 55°C (0°F to 130°F)
<b>Typical Weight:</b>	23.0 grams (0.8 oz.)
<b>Typical Volume:</b>	8.1 cubic centimeters (0.5 cubic inch)
<b>Jacket:</b>	Plastic Label
<b>Shelf Life:</b>	10 years at 21°C
<b>Terminal:</b>	Flat Contact

**Industry Standard Dimensions**

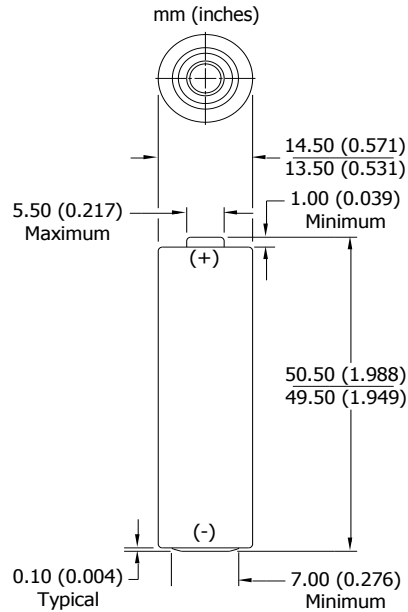

**Milliamp-Hours Capacity**

Continuous discharge to 0.8 volts at 21°C

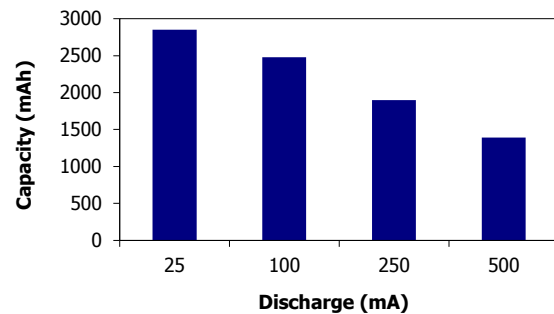

**Constant Power Performance**

Typical Characteristics (21°C)

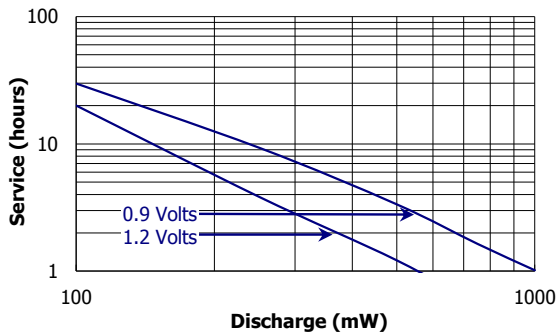

**Constant Current Performance**

Typical Characteristics (21°C)

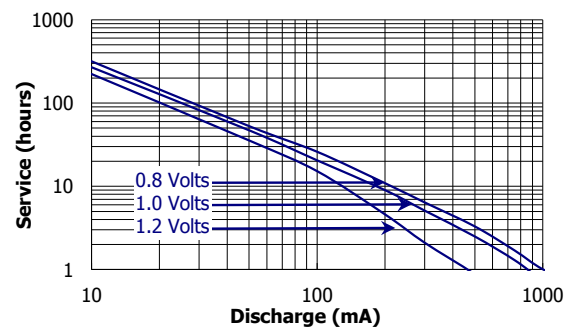

**Important Notice**

This data sheet contains typical information specific to products manufactured at the time of its publication.  
**Contents herein do not constitute a warranty and are for reference only.**

# ENERGIZER EN91

AA

## Constant Power Performance

Discharge Characteristics (21°C)

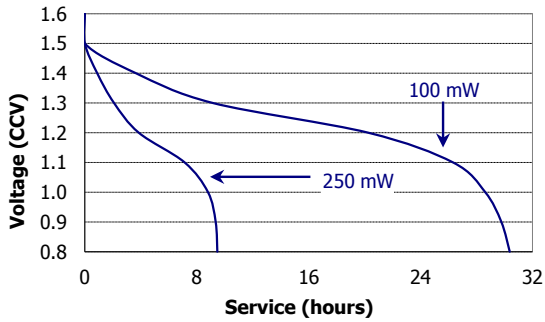

## Constant Current Performance

250 mA Discharge (-20°C / 0°C / 21°C)

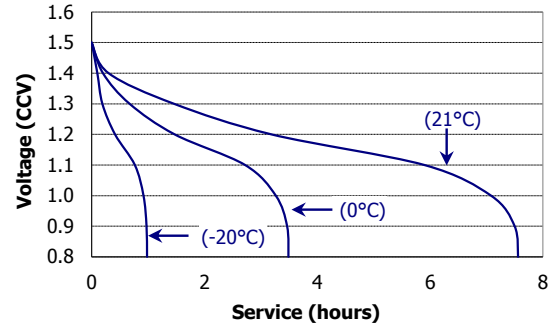

## Industry Standard Tests (21°C)

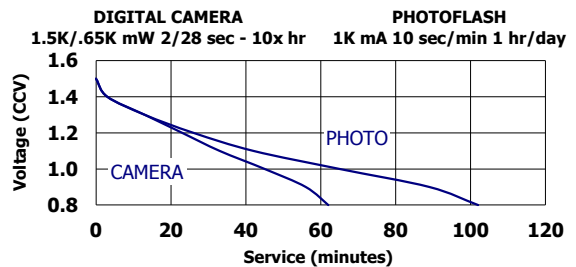
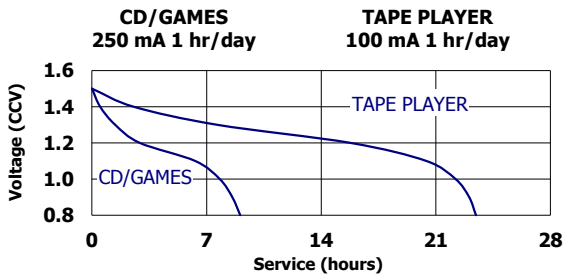
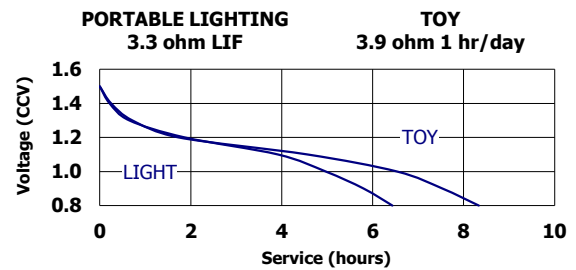
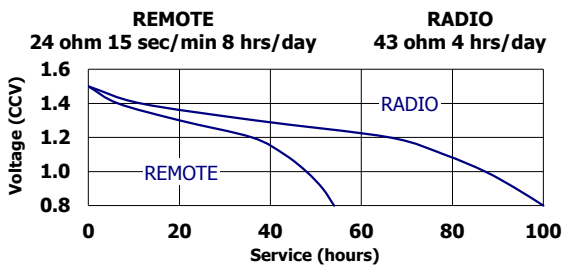

### Important Notice

This data sheet contains typical information specific to products manufactured at the time of its publication.  
**Contents herein do not constitute a warranty and are for reference only.**