

FD7-12

Description:

The FD7-12 Quick Pack small power transformer offers a significant reduction in size and weight over a standard transformer. This transformer can be used for a wide variety of applications. It is bobbin wound for reduced size and small operating space.

Electrical Specifications (@25C):

Maximum Power: 56.0VA

Input Voltage:

Series: 230VAC@50/60Hz

Parallel: 115VAC@50/60Hz

Output Voltage: 12.6VCT@4.0A¹

Recommended Fuse: UL listed 250VAC, 5.0A, Slo-Blo

Hipot: 2500VAC primary to secondary; 1500VAC windings to core.

Construction:

Split bobbin non concentric winding eliminates costly electrostatic shielding. Termination is suitable for quick connects or soldering. Built with UL Class B Insulation System.

Safety:

UL: File E53148, UL 5085-1 and 2 (formerly UL 506), General Purpose.

UL: File E65390, UL5085-1 and 3, Class 2 not wet, Class 3 wet



Dimensions:

A	B	C	D	E	F	G
2.250	3.125	3.687	1.812	2.687	.187 Dia	1.062

Notes: 1. Units: inches.

2. Terminal size: .187" X 0.021".

3. Weight: 1.70 lbs

Schematic:

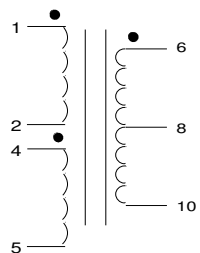

Output: 6 & 10

Input (115V): Input 1 & 2

Connect 1&4, 2&5

Input (230V): Input 1 & 5

Connect 2&4

RoHS Compliance: As of manufacturing date February 2016, all standard products meet the requirements of 2015/863/EU, known as the RoHS 3 initiative.

* Upon printing, this document is considered "uncontrolled". Please contact Triad Magnetics' website for the most current version.

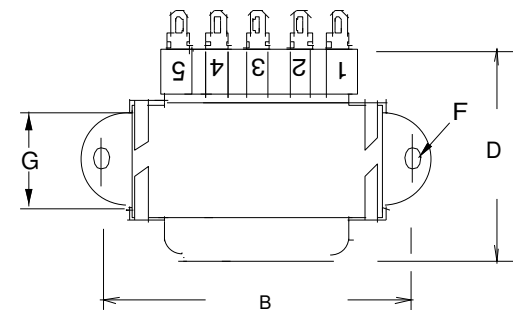
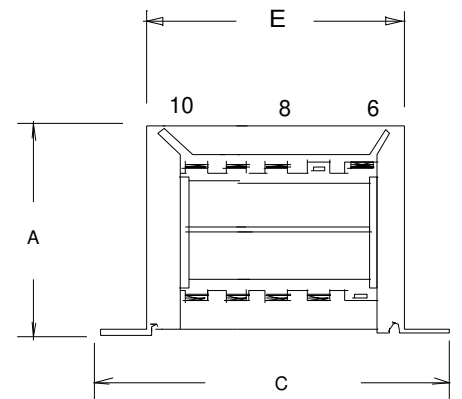
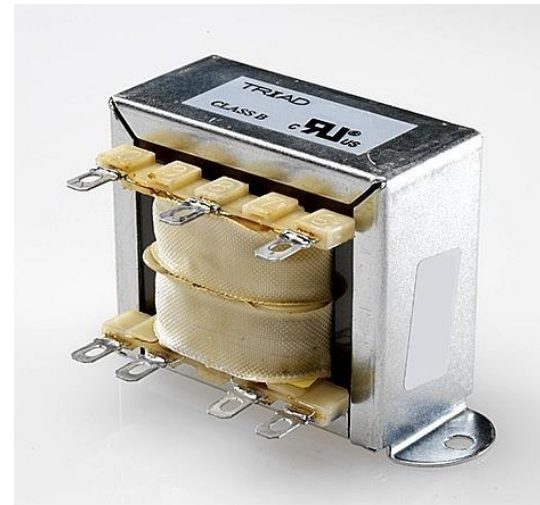

¹ Fuse must be used on **secondary** as conditions of acceptability for UL Class 2/3 operation