

GaAs PHEMT MMIC LOW NOISE AMPLIFIER, 6 - 20 GHz

Typical Applications

The HMC565 is ideal for use as a LNA or driver amplifier for:

- Point-to-Point Radios
- Point-to-Multi-Point Radios & VSAT
- Test Equipment and Sensors
- Military & Space

Features

- Noise Figure: 2.3 dB
- Gain: 22 dB
- OIP3: 20 dBm
- Single Supply: +3V @ 53 mA
- 50 Ohm Matched Input/Output
- Small size: 2.53 x 0.98 x 0.10 mm

Functional Diagram

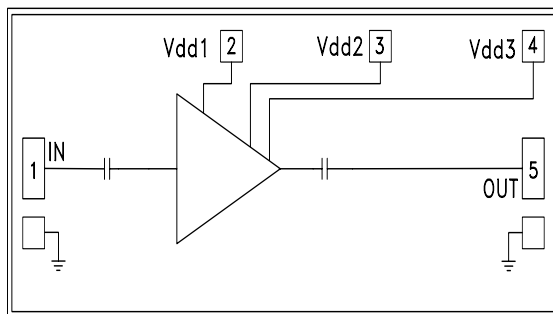

General Description

The HMC565 is a high dynamic range GaAs PHEMT MMIC Low Noise Amplifier (LNA) chip which operates from 6 to 20 GHz. The HMC565 features 22 dB of small signal gain, 2.3 dB of noise figure and has a consistent IP3 of 20 dBm across the operating band. This self-biased LNA is ideal for hybrid and MCM assemblies due to its compact size, wideband performance, single +3V supply operation, and DC blocked RF I/O's. All data is measured with the chip in a 50 Ohm test fixture connected via two 0.025 mm (1 mil) diameter bondwires of minimal length 0.31 mm (12 mil).

Electrical Specifications, $T_A = +25^\circ \text{C}$, Vdd 1, 2, 3 = +3V

| Parameter | Min. | Typ. | Max. | Min. | Typ. | Max. | Units |
|--|--------|-------|---------|------|-------|-------|--------|
| Frequency Range | 6 - 12 | | 12 - 20 | | | | GHz |
| Gain | 20 | 23 | | 17 | 21 | | dB |
| Gain Variation Over Temperature | | 0.025 | 0.035 | | 0.025 | 0.035 | dB/ °C |
| Noise Figure | | 2.3 | 2.8 | | 2.5 | 3.0 | dB |
| Input Return Loss | | 15 | | | 12 | | dB |
| Output Return Loss | | 15 | | | 10 | | dB |
| Output Power for 1 dB Compression (P1dB) | 7 | 10 | | 7 | 10 | | dBm |
| Saturated Output Power (Psat) | | 12 | | | 12 | | dBm |
| Output Third Order Intercept (IP3) | 17 | 20 | | 17 | 20 | | dBm |
| Supply Current (Idd)(Vdd = +3V) | | 53 | | | 53 | | mA |

GaAs PHEMT MMIC LOW NOISE AMPLIFIER, 6 - 20 GHz

Broadband Gain & Return Loss

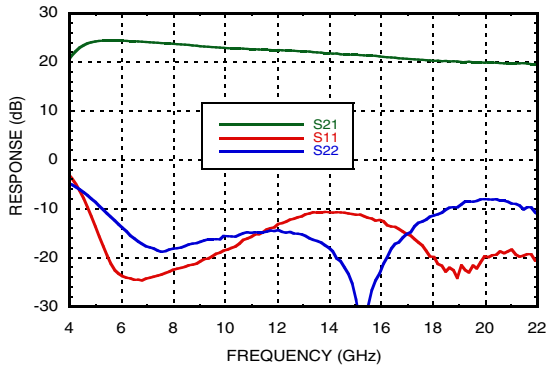

Gain vs. Temperature

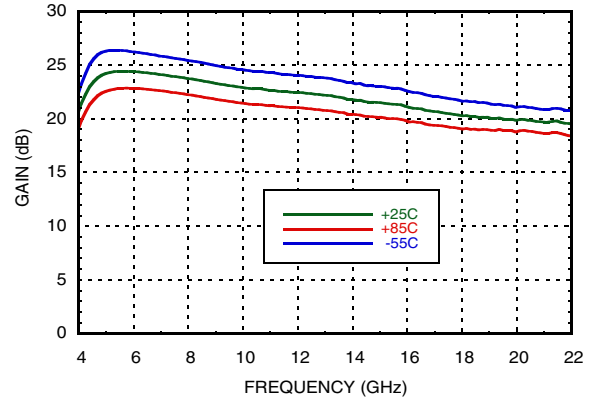

Input Return Loss vs. Temperature

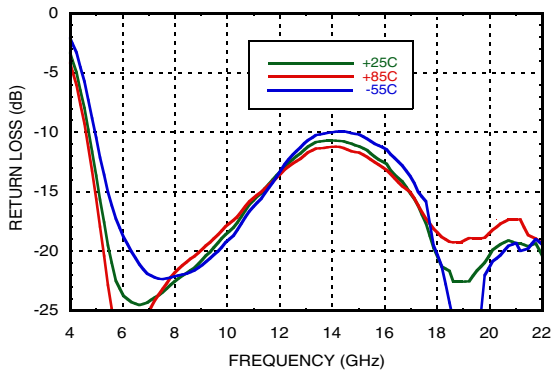

Output Return Loss vs. Temperature

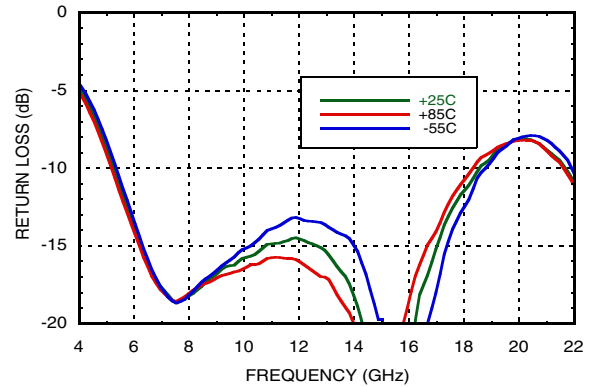

Noise Figure vs. Temperature

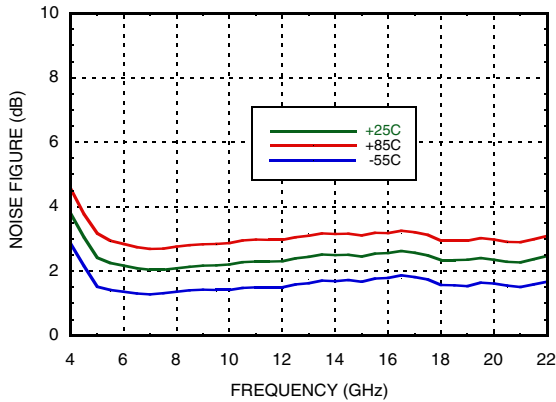

Reverse Isolation vs. Temperature

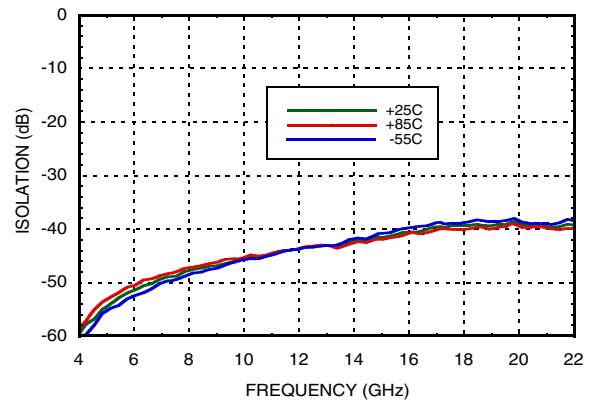

GaAs PHEMT MMIC LOW NOISE AMPLIFIER, 6 - 20 GHz

LOW NOISE AMPLIFIERS - CHIP

P1dB vs. Temperature

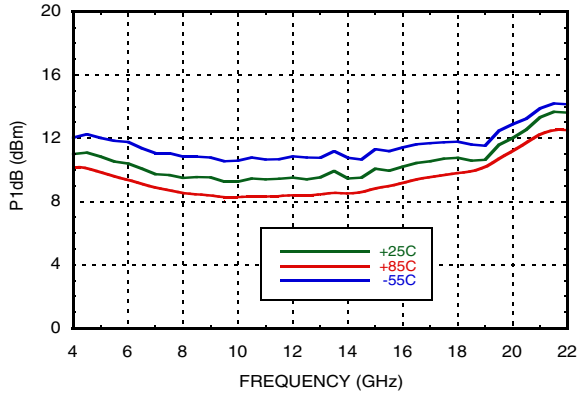

Psat vs. Temperature

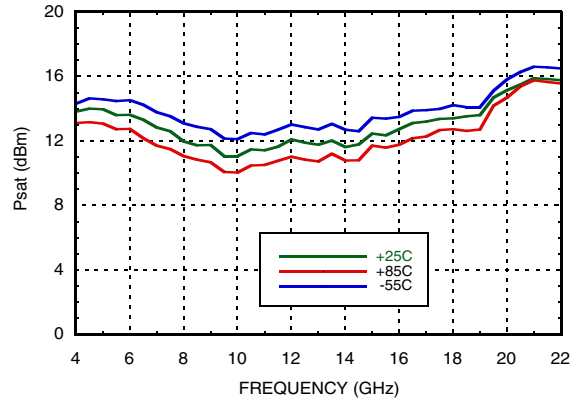

Output IP3 vs. Temperature

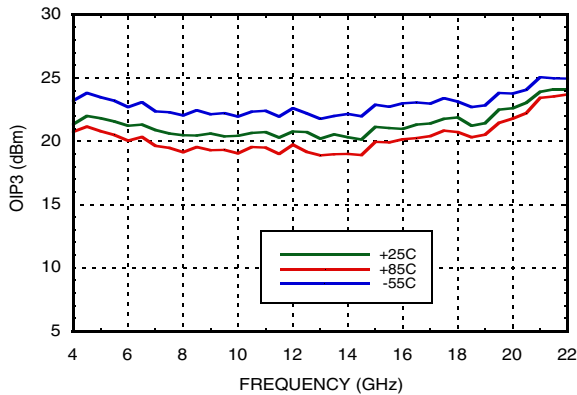

Power Compression @ 13 GHz

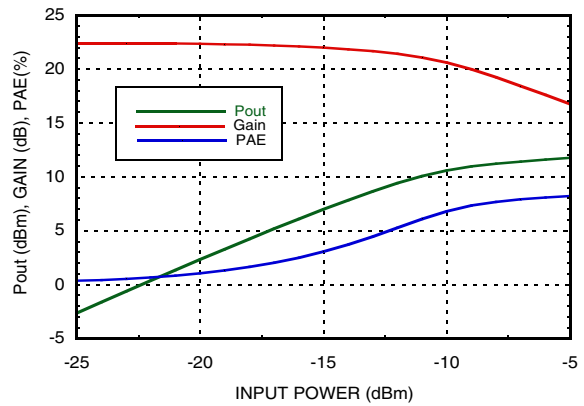

Gain, Noise Figure & Power vs. Supply Voltage @ 13 GHz

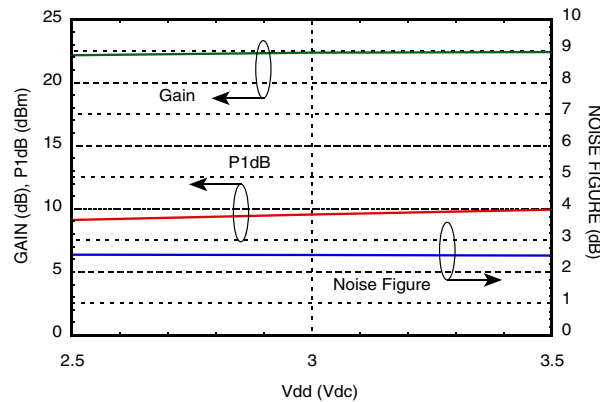

GaAs PHEMT MMIC LOW NOISE AMPLIFIER, 6 - 20 GHz

Absolute Maximum Ratings

| | |
|---|----------------|
| Drain Bias Voltage (Vdd1, Vdd2, Vdd3) | +3.5 Vdc |
| RF Input Power (RFIN)(Vdd = +3.0 Vdc) | 10 dBm |
| Channel Temperature | 175 °C |
| Continuous P _{diss} (T= 85 °C) (derate 8.9 mW/°C above 85 °C) | 0.75 W |
| Thermal Resistance (channel to die bottom) | 119 °C/W |
| Storage Temperature | -65 to +150 °C |
| Operating Temperature | -55 to +85 °C |
| ESD Sensitivity (HBM) | Class 1A |

Typical Supply Current vs. Vdd

| Vdd (Vdc) | I _{dd} (mA) |
|-----------|----------------------|
| +2.5 | 51 |
| +3.0 | 53 |
| +3.5 | 55 |

Note: Amplifier will operate over full voltage ranges shown above.



ELECTROSTATIC SENSITIVE DEVICE
OBSERVE HANDLING PRECAUTIONS

Outline Drawing

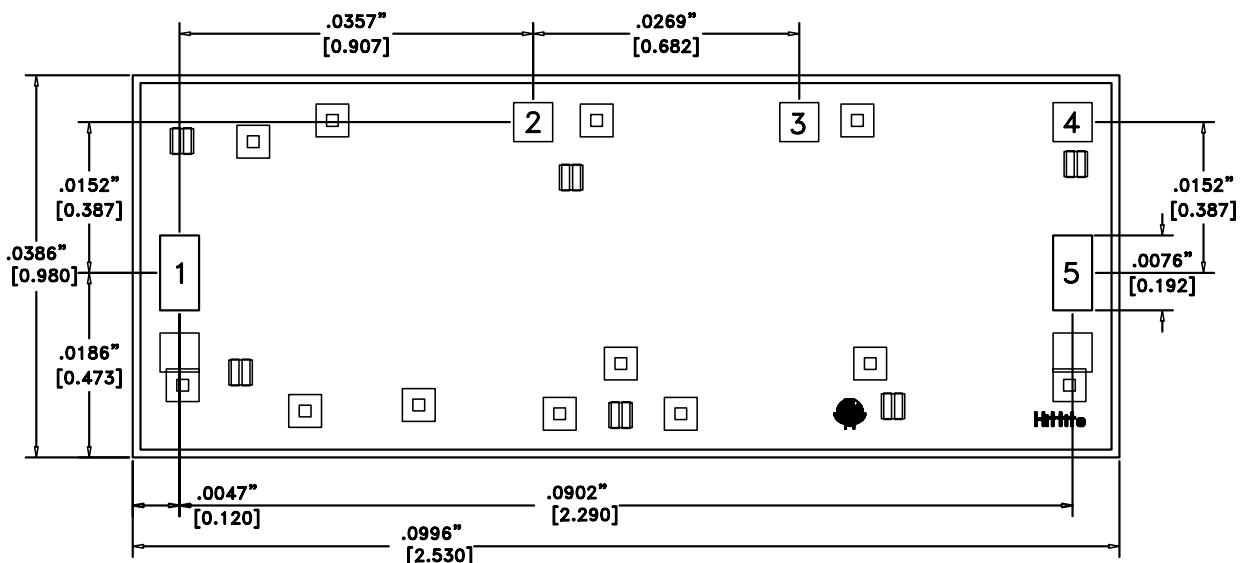

Die Packaging Information [1]

| Standard | Alternate |
|-----------------|-----------|
| GP-2 (Gel Pack) | [2] |

[1] Refer to the "Packaging Information" section for die packaging dimensions.

[2] For alternate packaging information contact Hittite Microwave Corporation.

NOTES:

- ALL DIMENSIONS ARE IN INCHES [MM]
- DIE THICKNESS IS .004"
- TYPICAL BOND IS .004" SQUARE
- BACKSIDE METALLIZATION: GOLD
- BOND PAD METALLIZATION: GOLD
- BACKSIDE METAL IS GROUND.
- CONNECTION NOT REQUIRED FOR UNLABELED BOND PADS.

GaAs PHEMT MMIC LOW NOISE AMPLIFIER, 6 - 20 GHz

Pad Descriptions

| Pad Number | Function | Description | Interface Schematic |
|------------|------------|---|---------------------|
| 1 | IN | This pad is AC coupled and matched to 50 Ohms from 6 - 20 GHz. | IN ○ — — |
| 2, 3, 4 | Vdd1, 2, 3 | Power Supply Voltage for the amplifier. External bypass capacitors of 100 pF and 0.1 μF are required. | ○ Vdd1,2,3 |
| 5 | OUT | This pad is AC coupled and matched to 50 Ohms from 6 - 20 GHz. | — — ○ OUT |
| Die Bottom | GND | Die Bottom must be connected to RF/DC ground. | ○ GND ⏏ |

Assembly Diagram

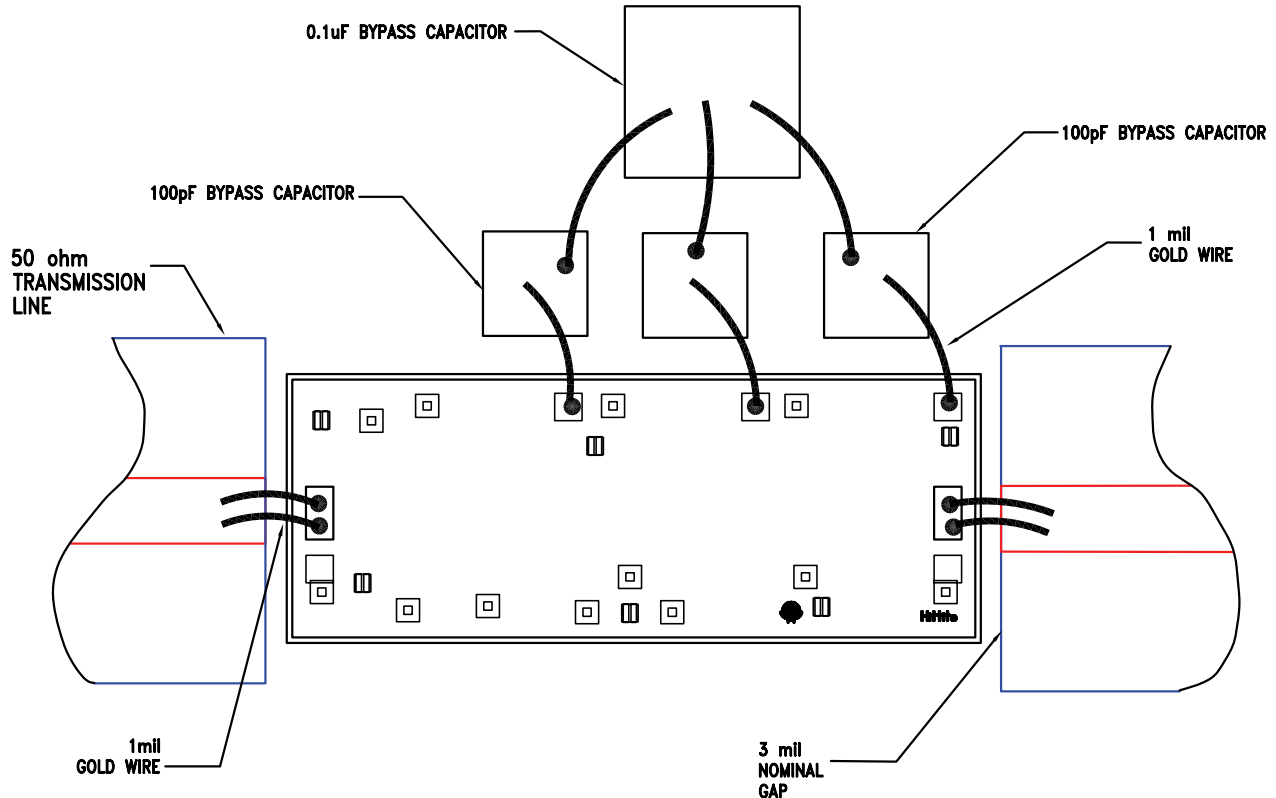

GaAs PHEMT MMIC LOW NOISE AMPLIFIER, 6 - 20 GHz

Mounting & Bonding Techniques for Millimeterwave GaAs MMICs

The die should be attached directly to the ground plane eutectically or with conductive epoxy (see HMC general Handling, Mounting, Bonding Note).

50 Ohm Microstrip transmission lines on 0.127mm (5 mil) thick alumina thin film substrates are recommended for bringing RF to and from the chip (Figure 1). If 0.254mm (10 mil) thick alumina thin film substrates must be used, the die should be raised 0.150mm (6 mils) so that the surface of the die is coplanar with the surface of the substrate. One way to accomplish this is to attach the 0.102mm (4 mil) thick die to a 0.150mm (6 mil) thick molybdenum heat spreader (moly-tab) which is then attached to the ground plane (Figure 2).

Microstrip substrates should be brought as close to the die as possible in order to minimize bond wire length. Typical die-to-substrate spacing is 0.076mm (3 mils).

Handling Precautions

Follow these precautions to avoid permanent damage.

Storage: All bare die are placed in either Waffle or Gel based ESD protective containers, and then sealed in an ESD protective bag for shipment. Once the sealed ESD protective bag has been opened, all die should be stored in a dry nitrogen environment.

Cleanliness: Handle the chips in a clean environment. DO NOT attempt to clean the chip using liquid cleaning systems.

Static Sensitivity: Follow ESD precautions to protect against $> \pm 250V$ ESD strikes.

Transients: Suppress instrument and bias supply transients while bias is applied. Use shielded signal and bias cables to minimize inductive pick-up.

General Handling: Handle the chip along the edges with a vacuum collet or with a sharp pair of bent tweezers. The surface of the chip has fragile air bridges and should not be touched with vacuum collet, tweezers, or fingers.

Mounting

The chip is back-metallized and can be die mounted with AuSn eutectic preforms or with electrically conductive epoxy. The mounting surface should be clean and flat.

Eutectic Die Attach: A 80/20 gold tin preform is recommended with a work surface temperature of 255 °C and a tool temperature of 265 °C. When hot 90/10 nitrogen/hydrogen gas is applied, tool tip temperature should be 290 °C. DO NOT expose the chip to a temperature greater than 320 °C for more than 20 seconds. No more than 3 seconds of scrubbing should be required for attachment.

Epoxy Die Attach: Apply a minimum amount of epoxy to the mounting surface so that a thin epoxy fillet is observed around the perimeter of the chip once it is placed into position. Cure epoxy per the manufacturer's schedule.

Wire Bonding

Ball or wedge bond with 0.025 mm (1 mil) diameter pure gold wire is recommended. Thermosonic wirebonding with a nominal stage temperature of 150 °C and a ball bonding force of 40 to 50 grams or wedge bonding force of 18 to 22 grams is recommended. Use the minimum level of ultrasonic energy to achieve reliable wirebonds. Wirebonds should be started on the chip and terminated on the package or substrate. All bonds should be as short as possible < 0.31 mm (12 mils).

