



2 dB NF Low Noise Amplifier, Operating from 20 MHz to 4 GHz with 25 dB Gain, 18 dBm P1dB and SMA

## TECHNICAL DATA SHEET

## PE15A1061

The PE15A1061 is a low noise coaxial amplifier operating in the 20 MHz to 4000 MHz frequency range. Impressive broadband typical performance includes 2 dB noise figure, 25 dB small signal gain, +18 dBm P1dB, and an output 3rd order intercept point of +34 dBm. This exceptional technical performance is achieved through the use of a hybrid MIC design and advanced E-pHEMT and HBT devices. The low noise amplifier requires a +5V DC power supply, and operates over a temperature range of -40°C to +75°C. The rugged and compact package supports SMA Female connectors and RFI and Ground pins. And for highly reliable operation, the model is guaranteed to meet MIL-STD-202 environmental test conditions for Humidity, Shock, Vibration, and Altitude.

### Features

- 20 MHz to 4000 MHz Frequency Range
- Low Noise Figure: 2 dB
- High Dynamic Range
- Efficient GaAs pHEMT Design
- Small Signal Gain: 25 dB
- Output P1dB: +18 dBm
- Output IP3: +34 dBm
- Operating Temperature: -40°C to +75°C
- 50 Ohm Input and Output Matched
- DC Power Supply: +5V / 160 mA
- SMA Female Connectors
- Designed to meet MIL-STD-202 Test Conditions

### Applications

- Test & Measurement
- R&D Labs
- General Purpose Amplification
- Aerospace & Defense
- Wireless Infrastructure
- Communication Systems

**Electrical Specifications** (TA = +25°C, DC Voltage = +5Vdc, DC Current = 160mA)

Description	Minimum	Typical	Maximum	Units
Frequency Range	0.02		4	GHz
Small Signal Gain	23	25		dB
Gain Flatness		±0.7	±1.5	dB
Output at 1 dB Compression Point*	+16	+18		dBm
Output 3rd Intercept Point*	+32	+34		dBm
Noise Figure		2	2.5	dB
Input VSWR*		1.6:1	2:1	
Output VSWR*		1.5:1	2:1	
Reverse Isolation*		-45		dB
Operating DC Voltage	+4.5	+5	+5.5	Volts
Operating DC Current		160	180	mA
Operating Temperature Range	-40		+75	°C

\*Test Frequency = 2 GHz

Click the following link (or enter part number in "SEARCH" on website) to obtain additional part information including price, inventory and certifications: [2 dB NF Low Noise Amplifier, Operating from 20 MHz to 4 GHz with 25 dB Gain, 18 dBm P1dB and SMA PE15A1061](#)



2 dB NF Low Noise Amplifier, Operating from 20 MHz to 4 GHz with 25 dB Gain, 18 dBm P1dB and SMA

## TECHNICAL DATA SHEET

## PE15A1061

### Absolute Maximum Rating

Parameter	Rating	Units
Supply Voltage	+6	V
RF Input Power	+13	dBm
Operating Temperature	-40 to +85	°C
Storage Temperature	-55 to +125	°C



ESD Sensitive Material,  
 Transport material in  
 Approved ESD bags.  
 Handle only in approved  
 ESD Workstation.

### Mechanical Specifications

#### Size

Length	1.25 in [31.75 mm]
Width	1.25 in [31.75 mm]
Height	0.563 in [14.3 mm]
Weight	0.085 lbs [38.56 g]
Input Connector	SMA Female
Output Connector	SMA Female

### Environmental Specifications

#### Temperature

Operating Range	-40 to +75 deg C
Storage Range	-55 to +125 deg C

Humidity  
 Shock  
 Vibration  
 Altitude

MIL-STD-202F, Method 103B, Condition B  
 MIL-STD-202F, Method 213B, Condition B  
 MIL-STD-202F, Method 204D, Condition B  
 MIL-STD-202F, Method 105C, Condition B

**Compliance Certifications** (see [product page](#) for current document)

### Plotted and Other Data

Notes:

- Values at +25 °C, sea level
- ESD Sensitive Material, Transport material in Approved ESD bags. Handle only in approved ESD Workstation.

Click the following link (or enter part number in "SEARCH" on website) to obtain additional part information including price, inventory and certifications: [2 dB NF Low Noise Amplifier, Operating from 20 MHz to 4 GHz with 25 dB Gain, 18 dBm P1dB and SMA PE15A1061](#)



2 dB NF Low Noise Amplifier, Operating from 20 MHz  
to 4 GHz with 25 dB Gain, 18 dBm P1dB and SMA

## TECHNICAL DATA SHEET

PE15A1061

### Amplifier Power-up Precautions

- 1.) Confirm that proper ESD precautions and controls are always in place before handling any Amplifier module.
- 2.) Confirm adequate thermal management is in place to effectively dissipate heat away from the Amplifier package. The Amplifier operational baseplate temperature must be within the operational temperature range stated in the Amplifier datasheet. Depending on the design and thermal requirements, using a heatsink with cooling fan is always recommended for safe reliable operation. A heat sink without a cooling fan may also be used. Damage caused from overheating will void the warranty.
- 3.) Confirm adequate system grounding is established. The DC power supply and Amplifier must have a common ground in order to operate properly.
- 4.) Power Amplifiers may require additional DC Current when initially powered-up. Depending on the design, the input current draw could range from an additional 10% to 100% above the maximum rated DC current of the Amplifier. This varies based on product part number.
- 5.) Confirm the DC power supply, if limited, is set to allow for additional start-up current that's rated for the Power Amplifier.
- 6.) Confirm the system is designed and calibrated for 50 ohms. Any impedance mismatch may cause performance issues.
- 7.) Perform a CALIBRATION (if required) with the loads before connecting the Amplifier to the Network Analyzer to ensure proper performance.
- 8.) Use a fixed attenuator between the signal source and input port of the Amplifier to optimize the input VSWR match.
- 9.) Confirm the input power level at the input port of the amplifier does not exceed the maximum rated limit for input power (as stated in the Amplifier datasheet).  
 $P_{in}$  for Small Signal Gain = P1dB-SSG-10 dB  
 $P_{in}$  for P1dB = P1dB-SSG+1 dB
- 10.) Confirm the Network Analyzer is always connected to the Amplifier first before DC power is applied to the Amplifier.
- 11.) As long as the input and output ports of the amplifier are connected to a 50Ohm load and RF signal power is applied, the Amplifier can be powered up with DC voltage.
- 12.) Confirm the Amplifier output load is matched for a 50 Ohm impedance and will not exceed the maximum rated VSWR or Return Loss limit for the Amplifier. Exceeding the maximum rated VSWR or Return Loss limit will result in reflected signal power that could damage the Amplifier and void the warranty.
- 13.) **Power Amplifier connected to an Antenna for signal transmission** - It's strongly recommended to use a high power fixed attenuator pad or an Isolator between the output port of the Amplifier and input port to the antenna. Any reflected signal power due to impedance mismatch will likely damage the Amplifier and void the warranty.
- 14.) The attenuator or isolator used at the output port of the Amplifier must be rated to handle the output power level and operational frequency band of the amplifier.

Click the following link (or enter part number in "SEARCH" on website) to obtain additional part information including price, inventory and certifications: [2 dB NF Low Noise Amplifier, Operating from 20 MHz to 4 GHz with 25 dB Gain, 18 dBm P1dB and SMA PE15A1061](#)



2 dB NF Low Noise Amplifier, Operating from 20 MHz to 4 GHz with 25 dB Gain, 18 dBm P1dB and SMA

**TECHNICAL DATA SHEET**

**PE15A1061**

**Typical Performance Data**

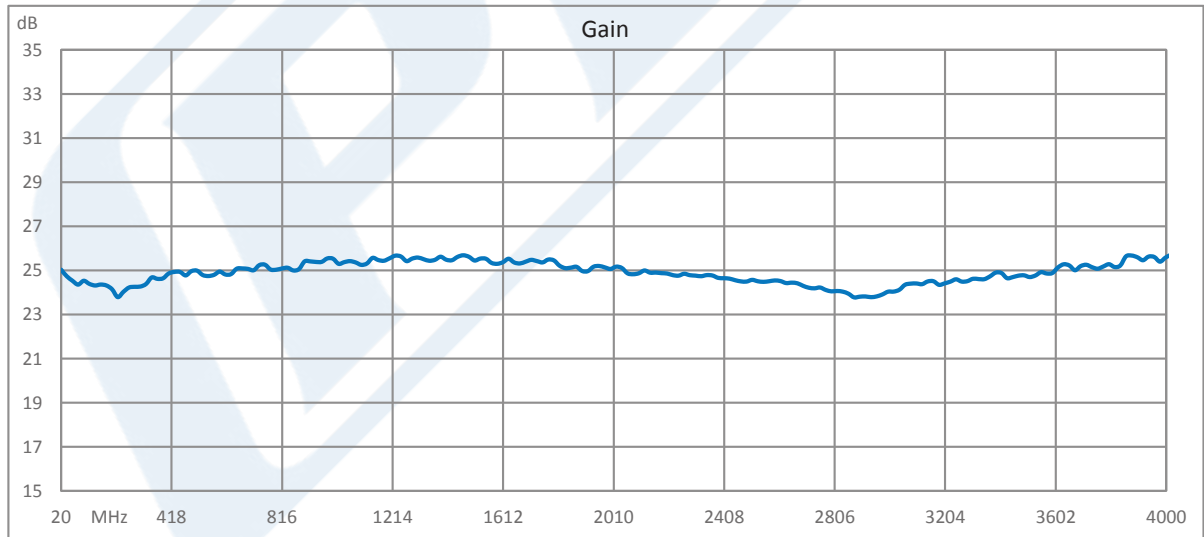
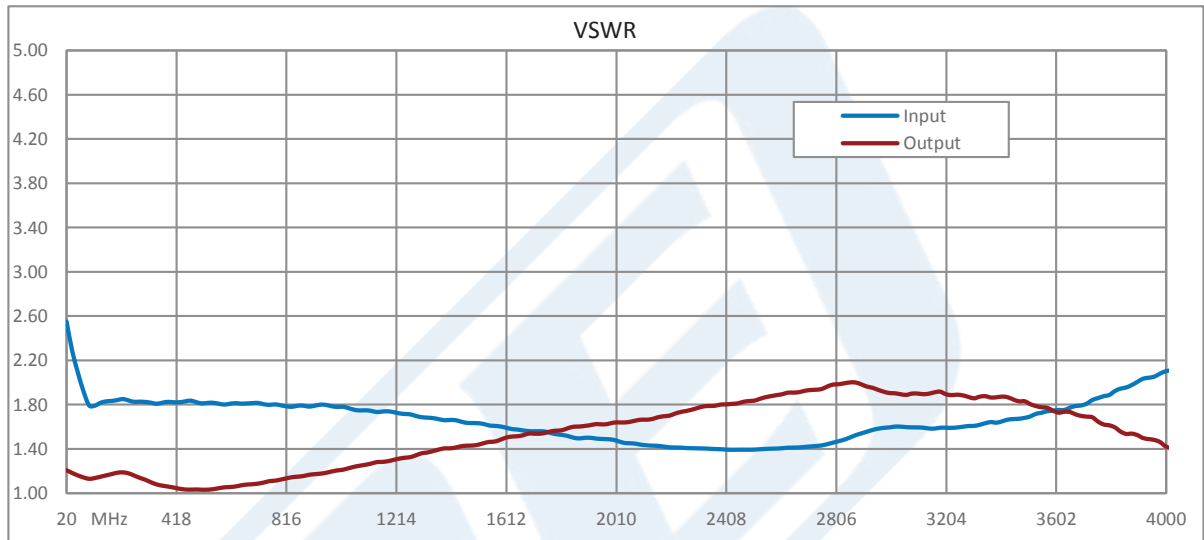

Click the following link (or enter part number in "SEARCH" on website) to obtain additional part information including price, inventory and certifications: [2 dB NF Low Noise Amplifier, Operating from 20 MHz to 4 GHz with 25 dB Gain, 18 dBm P1dB and SMA PE15A1061](#)



2 dB NF Low Noise Amplifier, Operating from 20 MHz to 4 GHz with 25 dB Gain, 18 dBm P1dB and SMA

**TECHNICAL DATA SHEET**

**PE15A1061**

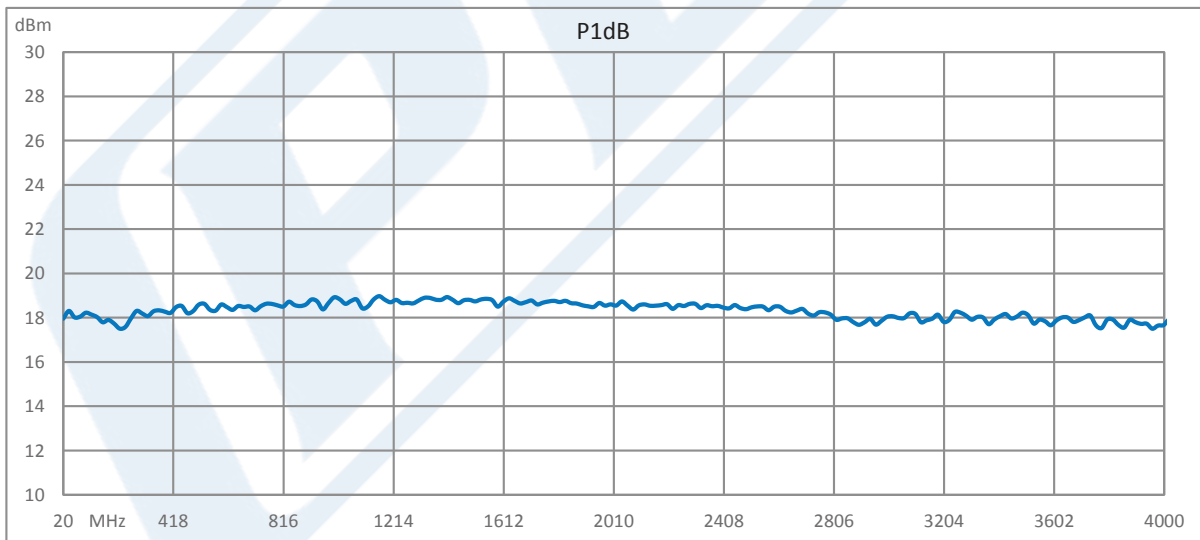
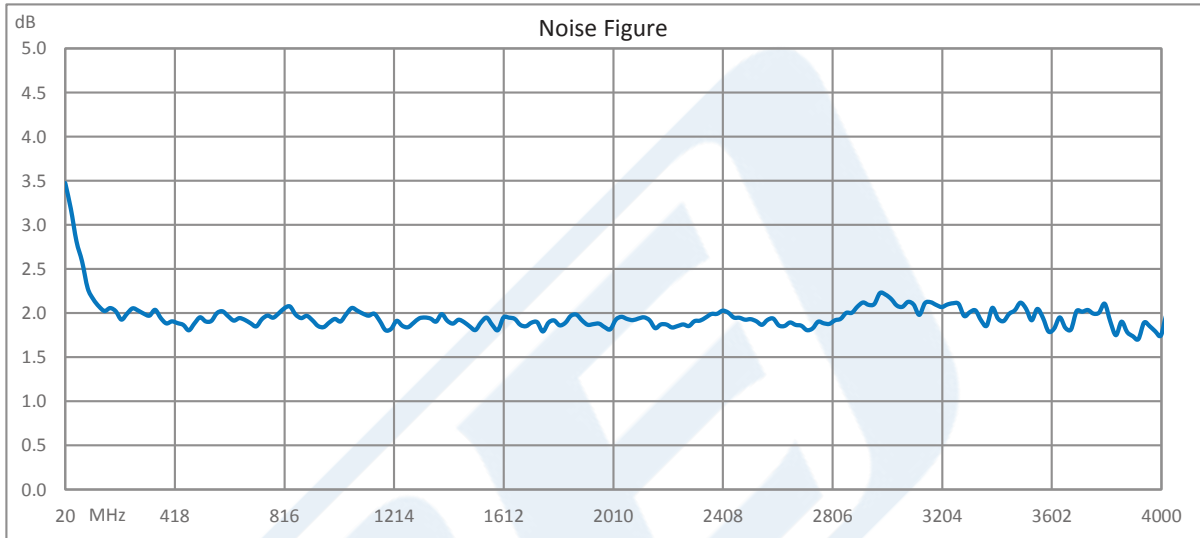

Click the following link (or enter part number in "SEARCH" on website) to obtain additional part information including price, inventory and certifications: [2 dB NF Low Noise Amplifier, Operating from 20 MHz to 4 GHz with 25 dB Gain, 18 dBm P1dB and SMA PE15A1061](#)



2 dB NF Low Noise Amplifier, Operating from 20 MHz to 4 GHz with 25 dB Gain, 18 dBm P1dB and SMA

**TECHNICAL DATA SHEET**

**PE15A1061**

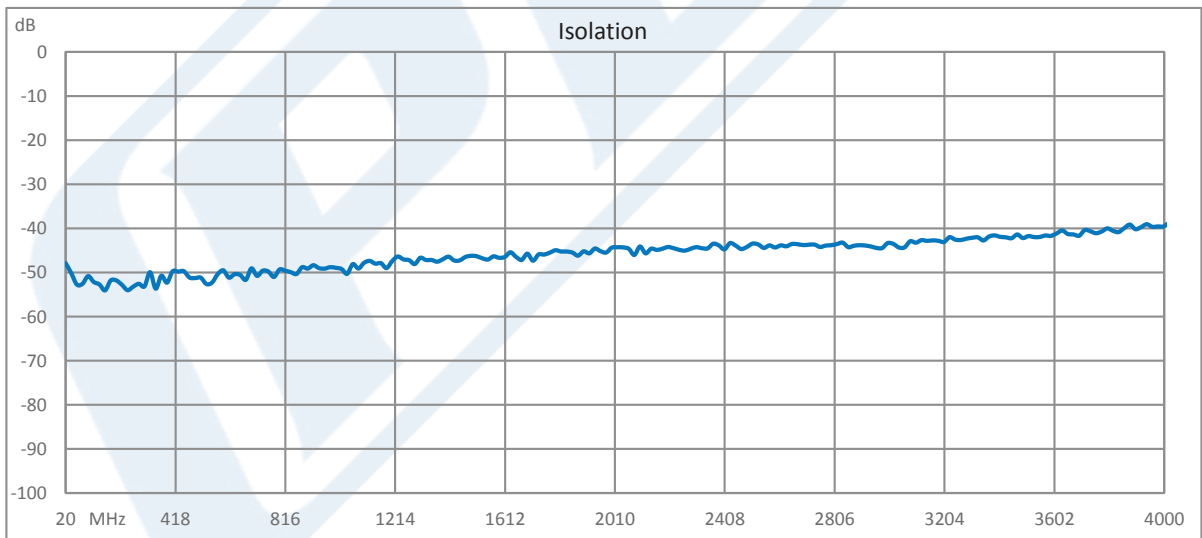
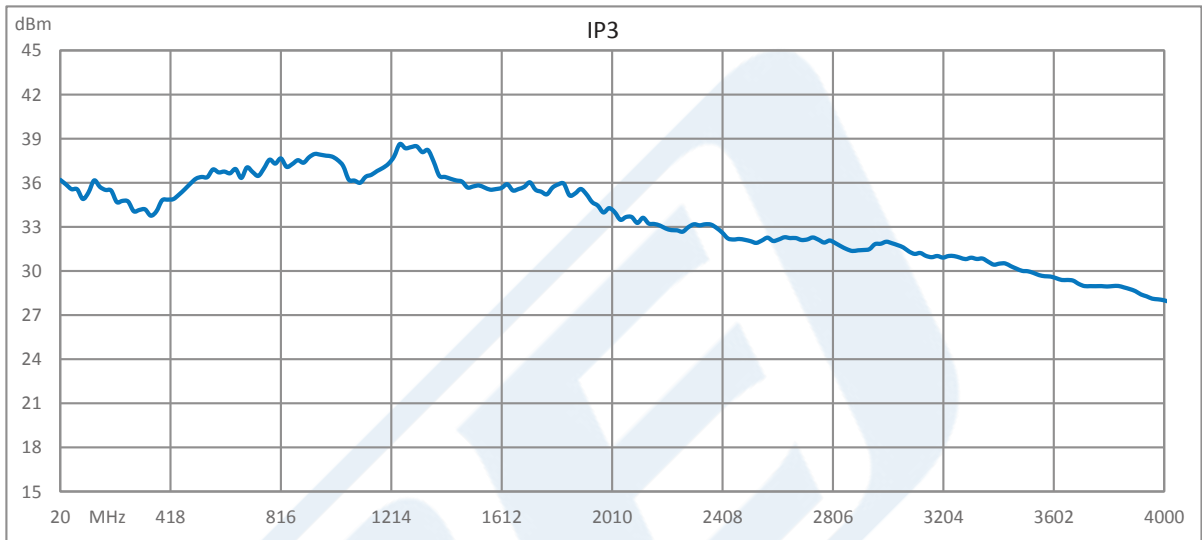

Click the following link (or enter part number in "SEARCH" on website) to obtain additional part information including price, inventory and certifications: [2 dB NF Low Noise Amplifier, Operating from 20 MHz to 4 GHz with 25 dB Gain, 18 dBm P1dB and SMA PE15A1061](#)



2 dB NF Low Noise Amplifier, Operating from 20 MHz  
to 4 GHz with 25 dB Gain, 18 dBm P1dB and SMA

## TECHNICAL DATA SHEET

**PE15A1061**

2 dB NF Low Noise Amplifier, Operating from 20 MHz to 4 GHz with 25 dB Gain, 18 dBm P1dB and SMA from Pasternack Enterprises has same day shipment for domestic and International orders. Our RF, microwave and millimeter wave products maintain a 99.4% availability and are part of the broadest selection in the industry.

Click the following link (or enter part number in "SEARCH" on website) to obtain additional part information including price, inventory and certifications: [2 dB NF Low Noise Amplifier, Operating from 20 MHz to 4 GHz with 25 dB Gain, 18 dBm P1dB and SMA PE15A1061](https://www.pasternack.com/2-db-4-ghz-low-noise-amplifier-25-db-gain-sma-pe15a1061-p.aspx)

URL: <https://www.pasternack.com/2-db-4-ghz-low-noise-amplifier-25-db-gain-sma-pe15a1061-p.aspx>

The information contained in this document is accurate to the best of our knowledge and representative of the part described herein. It may be necessary to make modifications to the part and/or the documentation of the part, in order to implement improvements. Pasternack reserves the right to make such changes as required. Unless otherwise stated, all specifications are nominal. Pasternack does not make any representation or warranty regarding the suitability of the part described herein for any particular purpose, and Pasternack does not assume any liability arising out of the use of any part or documentation.

# PE15A1061 CAD Drawing

2 dB NF Low Noise Amplifier, Operating from 20 MHz to 4 GHz with 25 dB Gain, 18 dBm P1dB and SMA

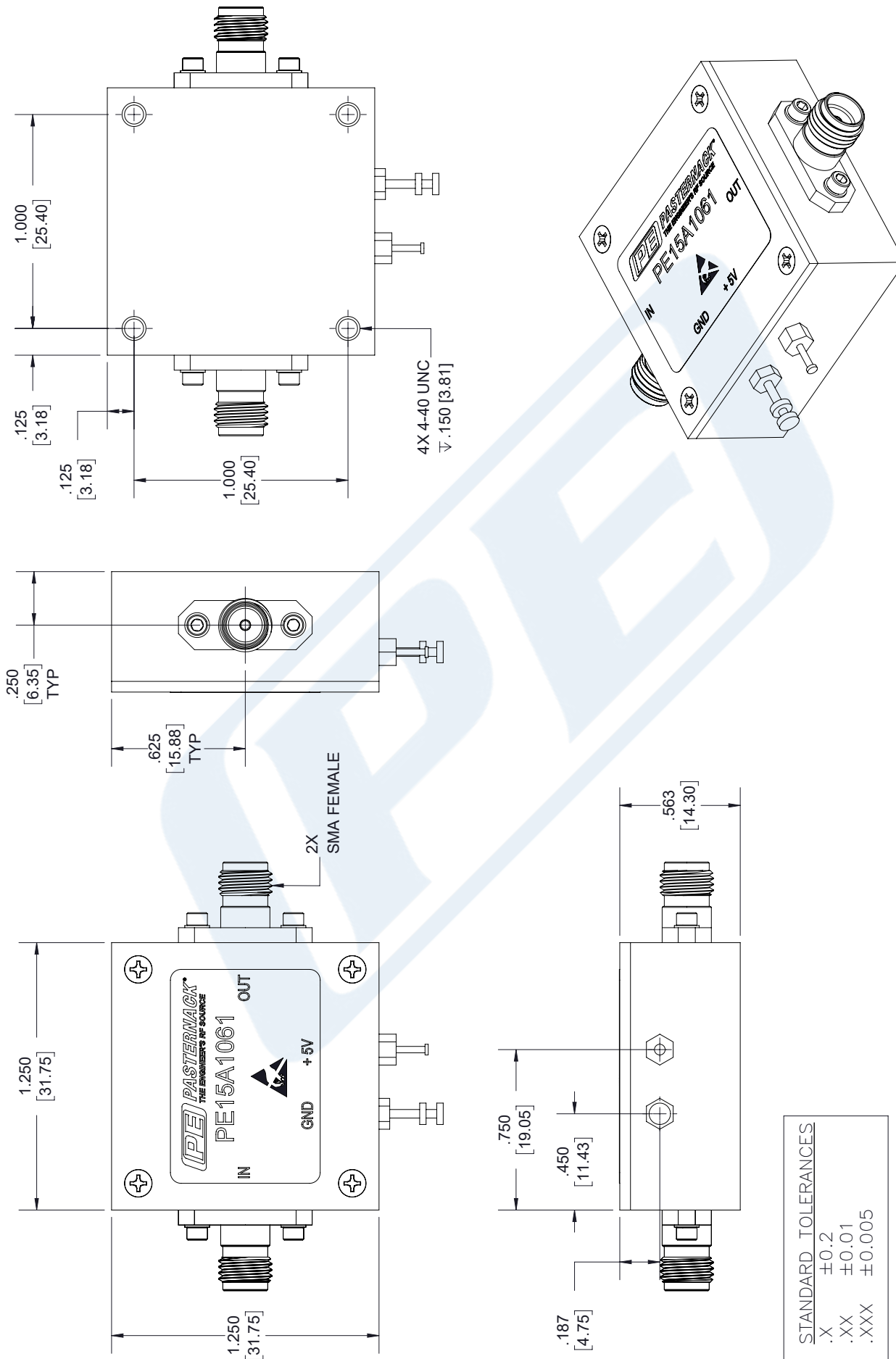

STANDARD TOLERANCES	
.X	±0.2
.XX	±0.01
.XXX	±0.005

\*STANDARD TOLERANCES APPLY ONLY TO DIMENSIONS IN INCHES

**PE PASTERNAK**  
 THE ENGINEER'S RF SOURCE  
 Pasternack Enterprises, Inc.  
 P.O. Box 16759 | Irvine | CA | 92623  
 Phone: (949) 261-1920 | Fax: (949) 261-7451  
 Website: www.pasternack.com | E-Mail: sales@pasternack.com

DWG TITLE	PE15A1061
CAGE CODE	53919

NOTES:	1. UNLESS OTHERWISE SPECIFIED ALL DIMENSIONS ARE NOMINAL. 2. ALL SPECIFICATIONS ARE SUBJECT TO CHANGE WITHOUT NOTICE AT ANY TIME. 3. DIMENSIONS ARE IN INCHES [mm].
CAD FILE	04/26/18
SCALE	N/A
SIZE	A
	7361