

### FEATURES:

- High Density uPOL Module
- 1000mA Output Current
- 95% Peak Efficiency at 12VIN
- Input Voltage Range from 4.5V to 17V
- Output Voltage Range from 1.0V to 5.0V
- Enable / PGOOD Function
- Automatic Power Saving/PWM Mode
- Protections (OCP: Non-latching, OTP)
- Adjustable Soft Start Function
- Compact Size: 3.5mm\*3.5mm\*1.7mm
- Pb-free for RoHS compliant
- MSL 2, 260°C Reflow

### APPLICATIONS:

- Point of Load Conversion
- LDOs Replacement
- Set Top Box / DSL Modem / AP Router
- Industrial Personal Computer

### GENERAL DESCRIPTION:

The uPOL module is non-isolated dc-dc converter that can deliver up to 1000mA of output current. The PWM switching regulator, high frequency power inductor are integrated in one hybrid package. It only needs input/output capacitors and one voltage dividing resistor to perform properly.

The module has automatic operation with PWM mode and power saving mode according to loading, through constant on-time control, the module offers a simpler control loop and faster transient response. Other features include remote enable function, internal soft-start, non-latching over current protection, power good, input under voltage locked-out capability.

The low profile and compact size package (3.5mm × 3.5mm × 1.7mm) is suitable for automated assembly by standard surface mount equipment. The uPOL module is Pb-free and RoHS compliance.

### TYPICAL APPLICATION CIRCUIT & PACKAGE:

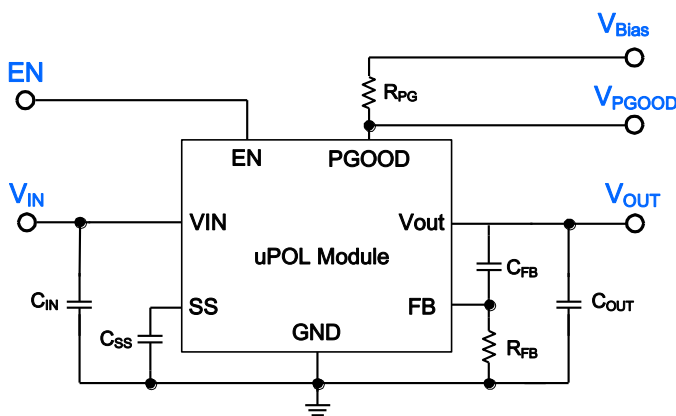

FIGURE.1 TYPICAL APPLICATION CIRCUIT

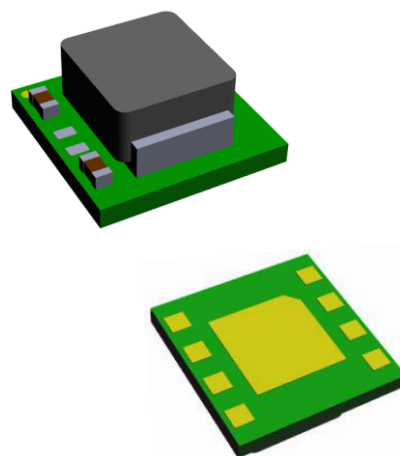
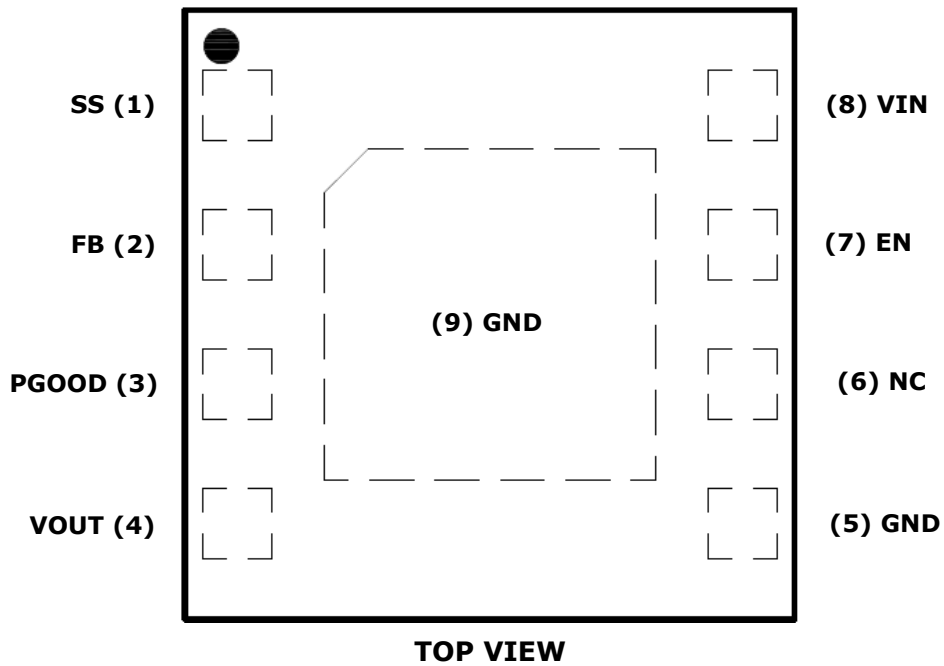

FIGURE.2 HIGH DENSITY LOW PROFILE  
uPOL MODULE

**ORDER INFORMATION:**

Part Number	Ambient Temp. Range (°C)	Package (Pb-Free)	MSL	Note
MUN12AD01-SH	-40 ~ +85	QFN	Level 2	-

Order Code	Packing	Quantity
MUN12AD01-SH	Tape and reel	1000

**PIN CONFIGURATION:**

**PIN DESCRIPTION:**

<b>Symbol</b>	<b>Pin No.</b>	<b>Description</b>
SS	1	Leave SS pin floating for default 1ms soft-start time. For longer than 1ms soft-start time, connect a capacitor from SS to GND. $T_{ss}(ms) = C_{ss}(nF) * 0.6V / 4\mu A$
FB	2	Feedback input. Connect an external resistor divider from the output to GND to set the output voltage.
PGOOD	3	Power Good indicator. The pin output is an open drain that can connect to VIN by resistor.
VOUT	4	Power output pin. Connect to output for the load.
GND	5, 9	Power ground pin for signal, input, and output return path. This pin needs to be connected to one or more ground plane directly.
NC	6	No connection
EN	7	On/Off control pin for module. EN = LOW, the module is off. EN = HIGH, the module is on. Do not float.
VIN	8	Power input pin. It needs to be connected to input rail.

**ELECTRICAL SPECIFICATIONS:**

CAUTION: Do not operate at or near absolute maximum rating listed for an extended period of time. This stress may adversely impact product reliability and result in failures outside of warranty.

Parameter	Description	Min.	Typ.	Max.	Unit
<b>■ Absolute Maximum Ratings</b>					
VIN to GND		-	-	+19.0	V
VOUT to GND		-	-	+6.5	V
FB to GND		-	-	+4.0	V
EN to GND		-	-	VIN+0.3	V
PGOOD to GND		-	-	+19.0	V
Tc	Case Temperature of Inductor	-	-	+110	°C
Tj	Junction Temperature	-40	-	+125	°C
Tstg	Storage Temperature	-40	-	+125	°C
ESD Rating	Human Body Model (HBM)	-	-	2k	V
	Machine Model (MM)	-	-	200	V
	Charge Device Model (CDM)	-	-	500	V
<b>■ Recommendation Operating Ratings</b>					
VIN	Input Supply Voltage	+4.5	-	+17.0	V
VOUT	Adjusted Output Voltage	+1.0	-	+5.0	V
PGOOD	Power Good Voltage	-	-	+17.0	V
Ta	Ambient Temperature	-40	-	+85	°C
<b>■ Thermal Information</b>					
Rth(jchoke-a)	Thermal resistance from junction to ambient. (Note 1)	-	51	-	°C/W

**NOTES:**

1. Rth(jchoke-a) is measured with the component mounted on an effective thermal conductivity test board on 0 LFM condition. The test board size is 42mm×42mm×1.6mm with 4 layers, 1oz. The test condition is complied with JEDEC EIJ/JESD 51 Standards.

**ELECTRICAL SPECIFICATIONS: (Cont.)**

Conditions:  $T_A = 25\text{ }^\circ\text{C}$ , unless otherwise specified. Test Board Information: 42mm×42mm×1.6mm, 4 layers, 1oz. The output ripple and transient response are measured by short loop probing and limited to 20MHz bandwidth.  $C_{in} = 22\mu\text{F}/25\text{V}/0805$ ,  $C_{out} = 47\mu\text{F}/10\text{V}/1206$ .

Symbol	Parameter	Conditions	Min.	Typ.	Max.	Unit
<b>■ Input Characteristics</b>						
$I_{SD(IN)}$	Input shutdown current	$V_{in} = 12\text{V}$ , $EN = \text{GND}$	-	5.5	-	$\mu\text{A}$
$I_{S(IN)}$	Input supply current	$V_{in} = 12\text{V}$ , $EN = V_{IN}$	-	-	-	-
		$I_{out} = 0\text{A}$ , $V_{out} = 3.3\text{V}$	-	0.25	-	$\text{mA}$
		$I_{out} = 1\text{mA}$ , $V_{out} = 3.3\text{V}$	-	0.6	-	$\text{mA}$
		$I_{out} = 100\text{mA}$ , $V_{out} = 3.3\text{V}$	-	33	-	$\text{mA}$
		$I_{out} = 1000\text{mA}$ , $V_{out} = 3.3\text{V}$	-	320	-	$\text{mA}$
<b>■ Output Characteristics</b>						
$I_{OUT(DC)}$	Output continuous current range	$V_{in} = 12\text{V}$ , $V_{out} = 3.3\text{V}$	0	-	1000	$\text{mA}$
$V_{O(SET)}$	Output voltage set point	With 0.5% tolerance for external resistor used to set output voltage	-3.0	-	+3.0	% $V_{O(SET)}$
$\frac{\Delta V_{OUT}}{\Delta V_{IN}}$	Line regulation accuracy	$V_{in} = 5\text{V}$ to $12\text{V}$ $V_{out} = 3.3\text{V}$ , $I_{out} = 0\text{A}$ $V_{out} = 3.3\text{V}$ , $I_{out} = 1000\text{mA}$	-	0.1	0.2	% $V_{O(SET)}$
$\frac{\Delta V_{OUT}}{\Delta I_{OUT}}$	Load regulation accuracy	$I_{out} = 0\text{A}$ to $1000\text{mA}$ $V_{in} = 12\text{V}$ , $V_{out} = 3.3\text{V}$	-	0.5	1.0	% $V_{O(SET)}$
$V_{OUT(AC)}$	Output ripple voltage	$V_{in} = 12\text{V}$ , $V_{out} = 3.3\text{V}$ $EN = V_{IN}$	-	-	-	-
		$I_{out} = 1\text{mA}$	-	14	-	$\text{mVp-p}$
		$I_{out} = 1000\text{mA}$	-	8	-	$\text{mVp-p}$
<b>■ Control Characteristics</b>						
$V_{REF}$	Reference voltage		0.591	0.600	0.609	$\text{V}$
$F_{OSC}$	Oscillator frequency	PWM Operation	-	1.0	-	$\text{MHz}$
$V_{UVLO}$	Input UVLO threshold		-	-	4.5	$\text{V}$
$V_{PGL}$	PGOOD output low	$I_{PGOOD} = 4\text{mA}$	0.04	0.15	0.3	$\text{V}$
$V_{EN\_TH}$	Enable rising threshold voltage		1.5	-	-	$\text{V}$
	Enable falling threshold voltage		-	-	0.4	$\text{V}$
<b>■ Fault Protection</b>						
$T_{OTP}$	Over temp protection		-	150	-	$^\circ\text{C}$
$I_{LIMIT\_TH}$	Current limit threshold	Peak value of inductor current	1.3	-	2.3	$\text{A}$

**TYPICAL PERFORMANCE CHARACTERISTICS: (1.0VOUT)**

Conditions:  $T_A = 25\text{ }^\circ\text{C}$ , unless otherwise specified. Test Board Information: 42mm×42mm×1.6mm, 4 layers, 1oz. The output ripple and transient response are measured by short loop probing and limited to 20MHz bandwidth.  $C_{in} = 22\mu\text{F}/25\text{V}/0805$ ,  $C_{out} = 47\mu\text{F}/10\text{V}/1206$ . The following figures are the typical characteristic curves at 1.0Vout.

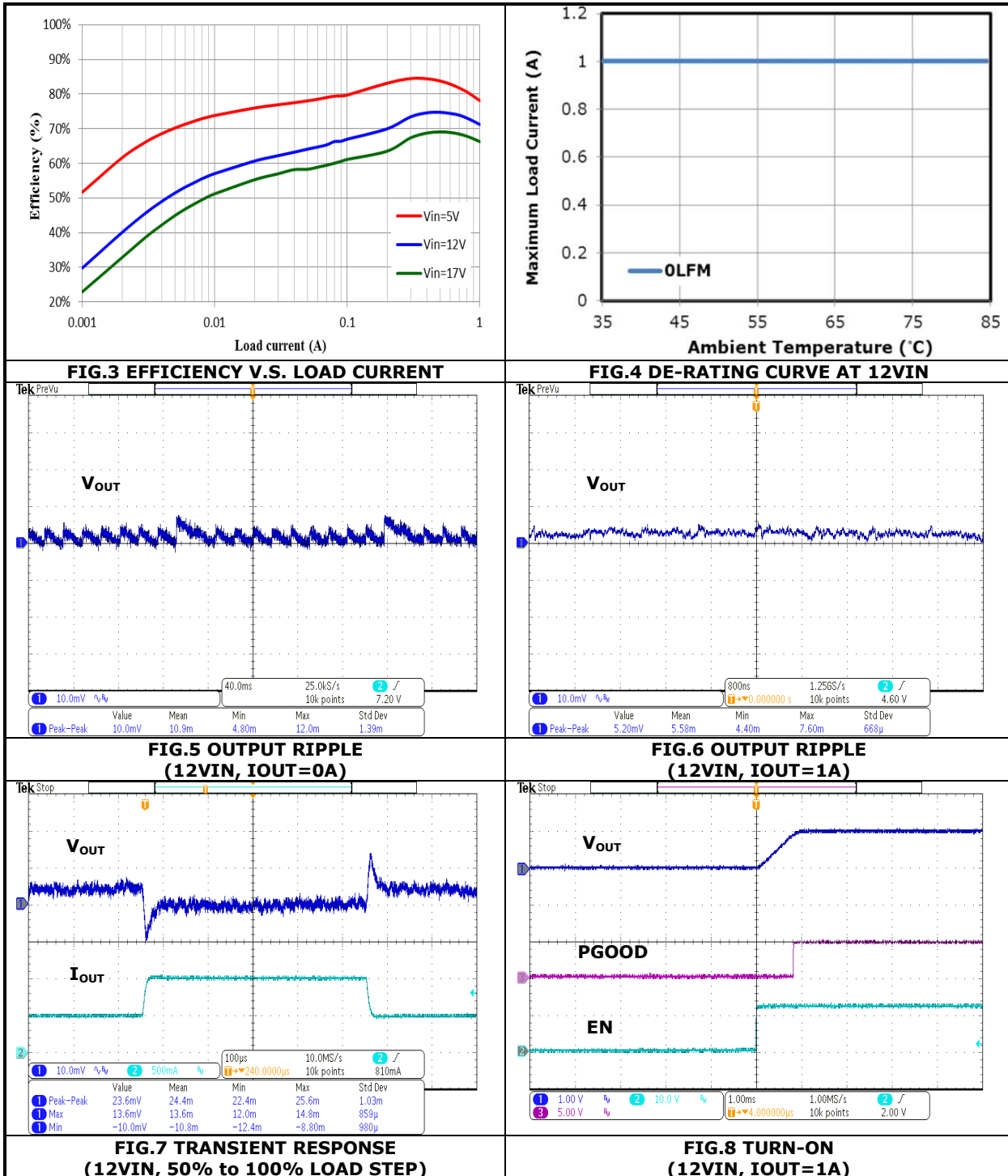

## TYPICAL PERFORMANCE CHARACTERISTICS: (1.8VOUT)

Conditions:  $T_A = 25^\circ\text{C}$ , unless otherwise specified. Test Board Information: 42mm×42mm×1.6mm, 4 layers, 1oz. The output ripple and transient response are measured by short loop probing and limited to 20MHz bandwidth.  $C_{in} = 22\mu\text{F}/25\text{V}/0805$ ,  $C_{out} = 47\mu\text{F}/10\text{V}/1206$ . The following figures are the typical characteristic curves at 1.8Vout.

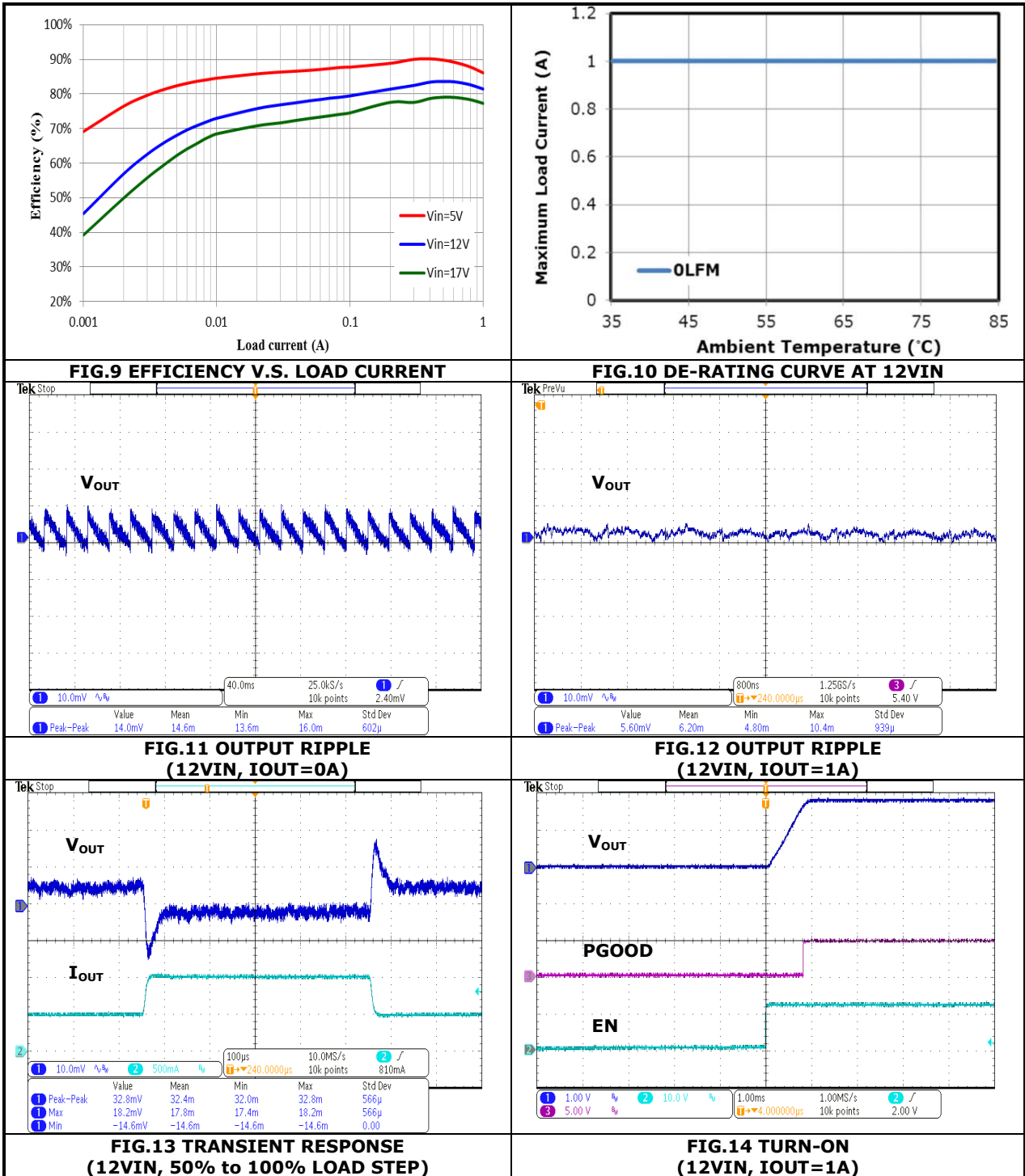

**TYPICAL PERFORMANCE CHARACTERISTICS: (3.3VOUT)**

Conditions:  $T_A = 25\text{ }^\circ\text{C}$ , unless otherwise specified. Test Board Information: 42mm×42mm×1.6mm, 4 layers, 1oz. The output ripple and transient response are measured by short loop probing and limited to 20MHz bandwidth.  $C_{in} = 22\mu\text{F}/25\text{V}/0805$ ,  $C_{out} = 47\mu\text{F}/10\text{V}/1206$ . The following figures are the typical characteristic curves at 3.3Vout.

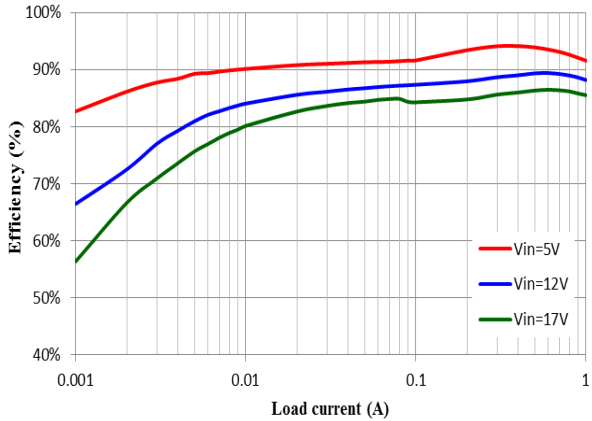
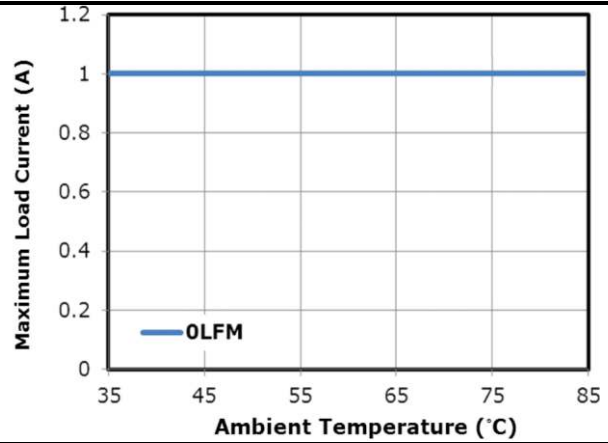
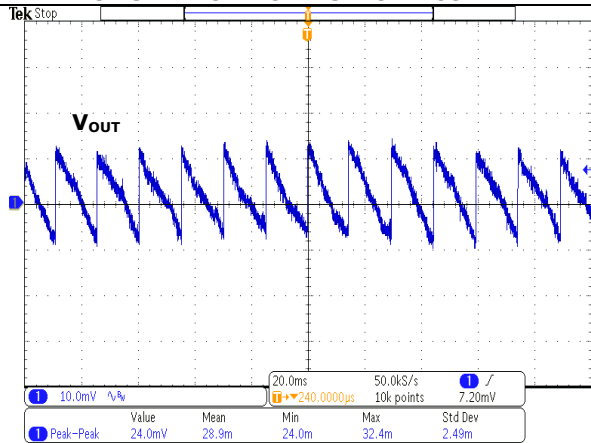
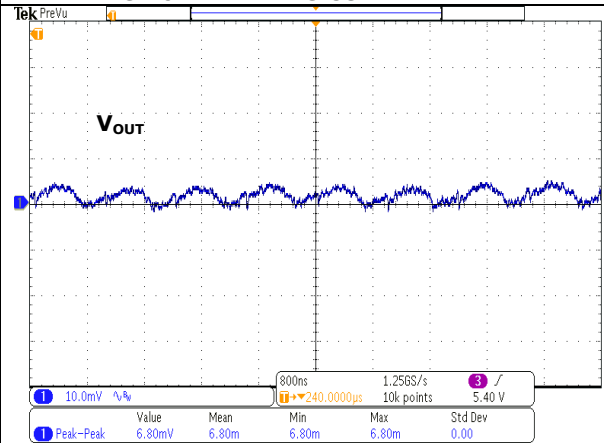
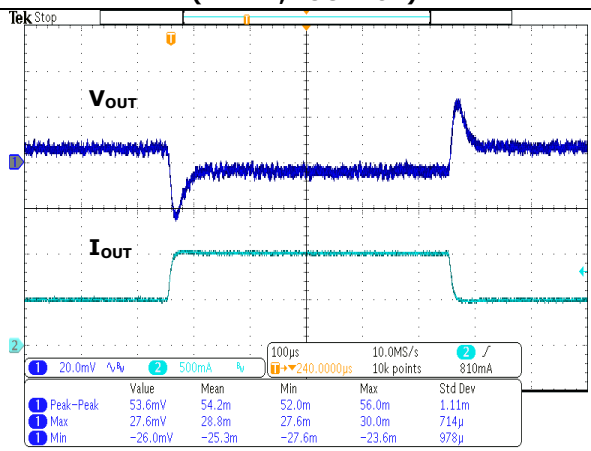
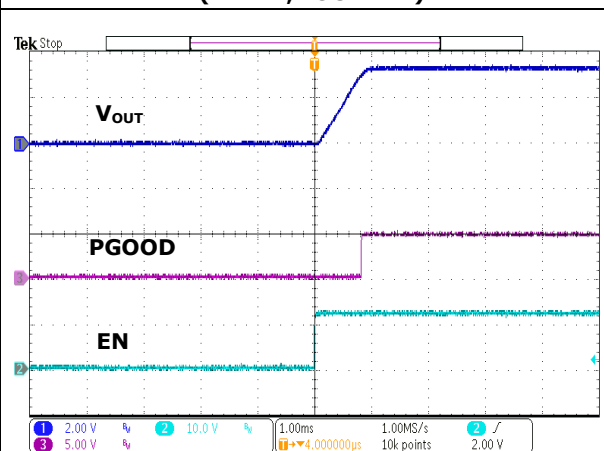
**FIG.15 EFFICIENCY V.S. LOAD CURRENT**

**FIG.16 DE-RATING CURVE AT 12VIN**

**FIG.17 OUTPUT RIPPLE (12VIN, IOU=0A)**

**FIG.18 OUTPUT RIPPLE (12VIN, IOU=1A)**

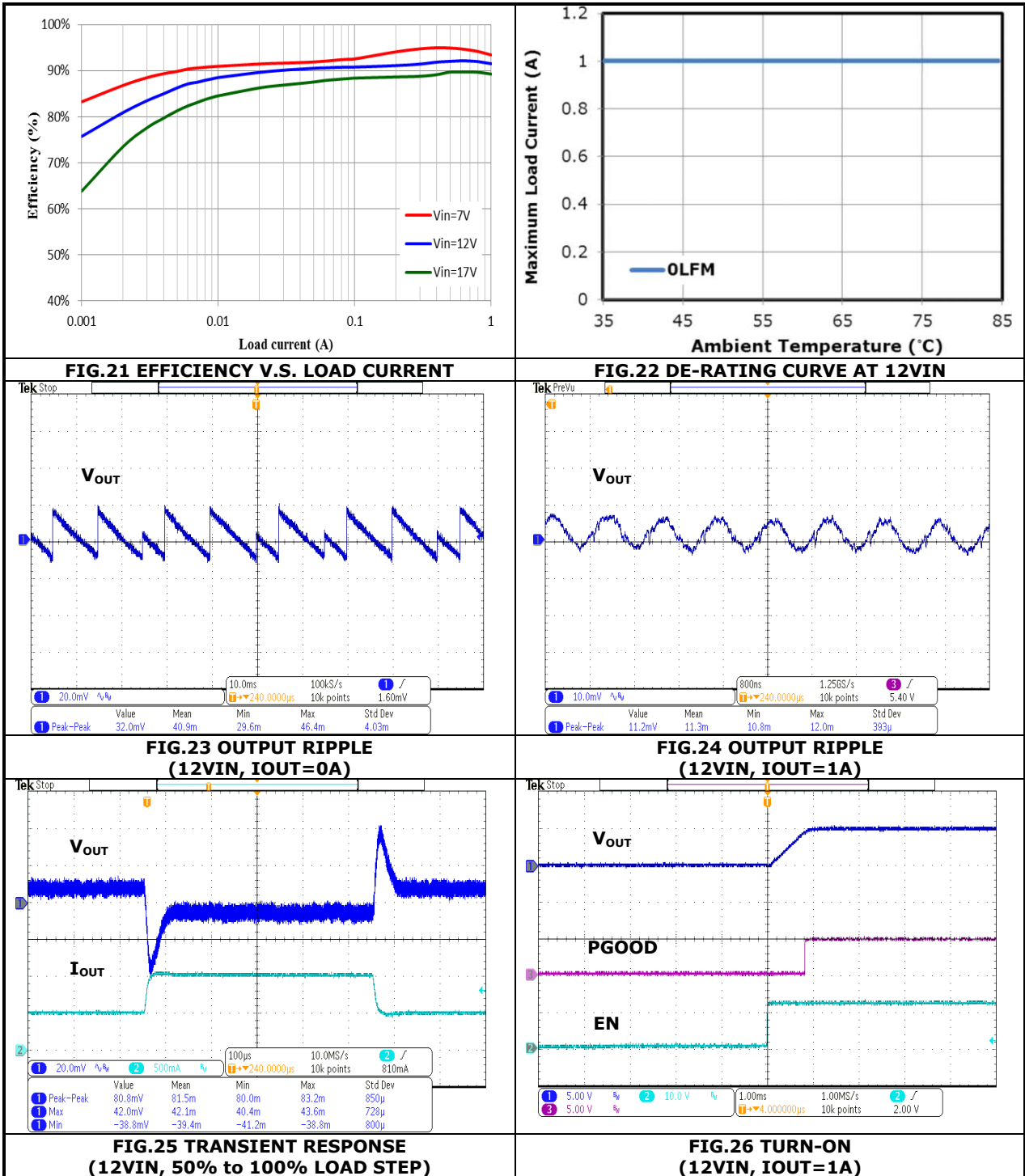
**FIG.19 TRANSIENT RESPONSE (12VIN, 50% to 100% LOAD STEP)**

**FIG.20 TURN-ON (12VIN, IOU=1A)**



## TYPICAL PERFORMANCE CHARACTERISTICS: (5.0VOUT)

Conditions:  $T_A = 25\text{ }^\circ\text{C}$ , unless otherwise specified. Test Board Information: 42mm×42mm×1.6mm, 4 layers, 1oz. The output ripple and transient response are measured by short loop probing and limited to 20MHz bandwidth.  $C_{in} = 22\mu\text{F}/25\text{V}/0805$ ,  $C_{out} = 47\mu\text{F}/10\text{V}/1206$ . The following figures are the typical characteristic curves at 5.0Vout.



**APPLICATIONS INFORMATION:**
**REFERENCE CIRCUIT FOR GENERAL APPLICATION:**

Figure 27 shows the module application schematics for input voltage +12V and turn on by input voltage directly through enable resistor (REN).

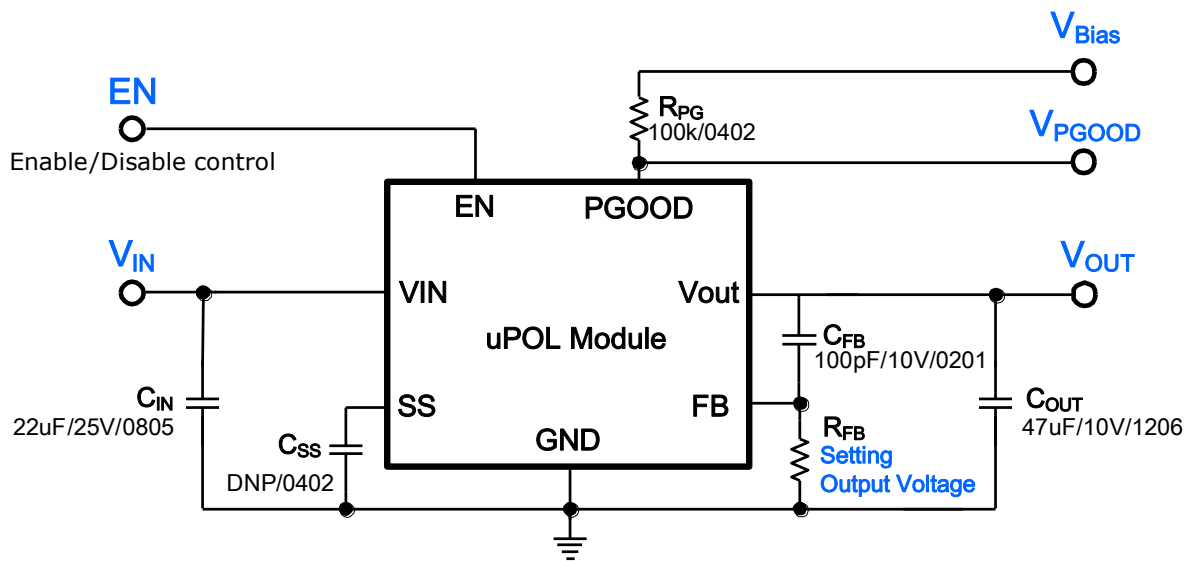
**FIG.27 REFERENCE CIRCUIT FOR GENERAL APPLICATION**

**APPLICATIONS INFORMATION: (Cont.)**
**RECOMMENDATION LAYOUT GUIDE:**

In order to achieve stable, low losses, less noise or spike, and good thermal performance some layout considerations are necessary. The recommendation layout is shown as Figure 28.

1. The ground connection between pin 5 and 9 should be a solid ground plane under the module. It can be connected one or more ground plane by using several Vias.
2. Place high frequency ceramic capacitors between pin 4 (VOUT), and pin 5, 9 (GND) for output side, as close to module as possible to minimize high frequency noise.
3. Keep the  $R_{FB}$  and  $C_{FB}$  connection trace to the module pin 2 (FB) short.
4. Use large copper area for power path (VIN, VOUT, and GND) to minimize the conduction loss and enhance heat transferring. Also, use multiple Vias to connect power planes in different layer.

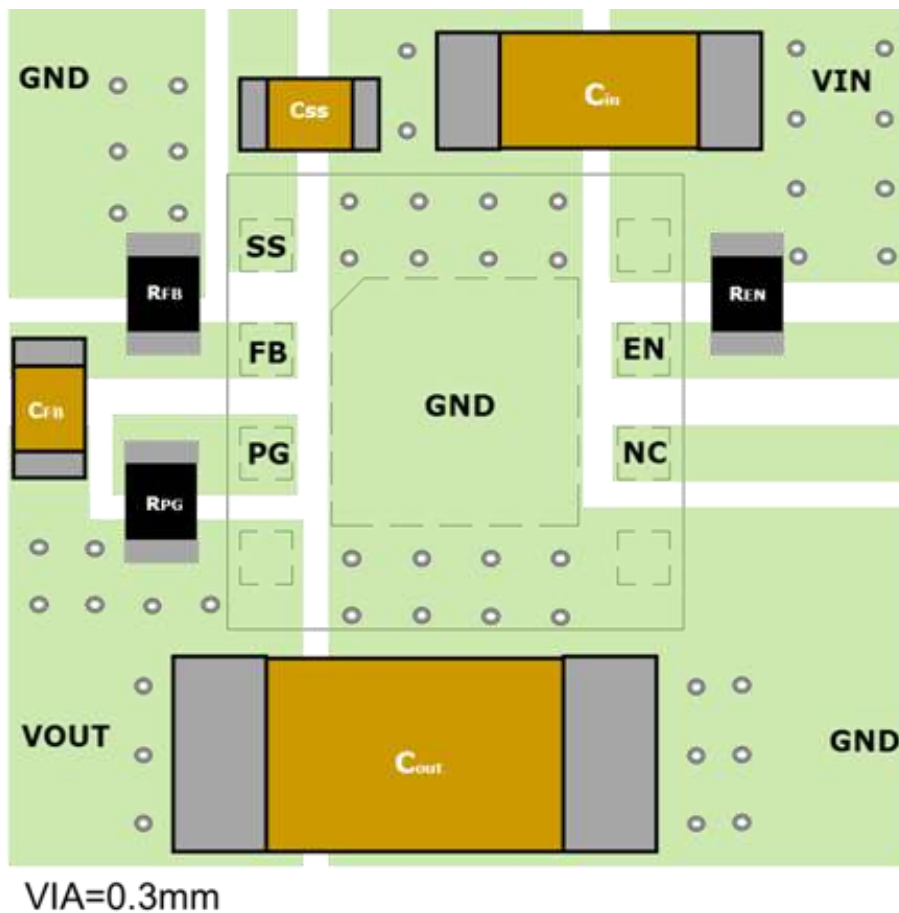
**FIG.28 RECOMMENDATION LAYOUT**

**APPLICATIONS INFORMATION: (Cont.)****SAFETY CONSIDERATIONS:**

Certain applications and/or safety agencies may require fuses at the inputs of power conversion components. Fuses should also be used when there is the possibility of sustained input voltage reversal which is not current limited. For greatest safety, we recommend a fast blow fuse installed in the ungrounded input supply line. The installer must observe all relevant safety standards and regulations. For safety agency approvals, install the converter in compliance with the end-user safety standard.

**INPUT FILTERING:**

The module should be connected to a source supply of low AC impedance and high inductance in which line inductance can affect the module stability. An input capacitor must be placed as near as possible to the input pin of the module so to minimize input ripple voltage and ensure module stability.

**OUTPUT FILTERING:**

To reduce output ripple and improve the dynamic response as the step load changes, an additional capacitor at the output must be connected. Low ESR polymer and ceramic capacitors are recommended to improve the output ripple and dynamic response of the module.

**PROGRAMMING OUTPUT VOLTAGE:**

The module has an internal  $0.6V \pm 2\%$  reference voltage. The output voltage can be programmed by the dividing resistor (RFB) which connects to both FB pin and GND pin. The output voltage can be calculated by Equation 1, resistor choice may be referred to TABLE 1.

$$V_{OUT} (V) = 0.6 \times \left( 1 + \frac{100k}{R_{FB}} \right) \quad (EQ.1)$$

VOUT (V)	RFB(kΩ)
1.0	150(1%)
1.2	100(1%)
1.8	50(1%)
2.5	31.6(1%)
3.3	22.1(1%)

**TABLE 1 Resistor values for common output voltages**

**APPLICATIONS INFORMATION: (Cont.)****Thermal Considerations:**

All of thermal testing condition is complied with JEDEC EIJ/JESD 51 Standards. Therefore, the test board size is 42mm×42mm×1.6mm with 4 layers. The case temperature of module sensing point is shown as Figure 29. Then  $R_{th(j_{choke}-a)}$  is measured with the component mounted on an effective thermal conductivity test board on 0 LFM condition. The MUN12AD01-SH power module is designed for using when the case temperature is below 110°C regardless the change of output current, input/output voltage or ambient temperature.

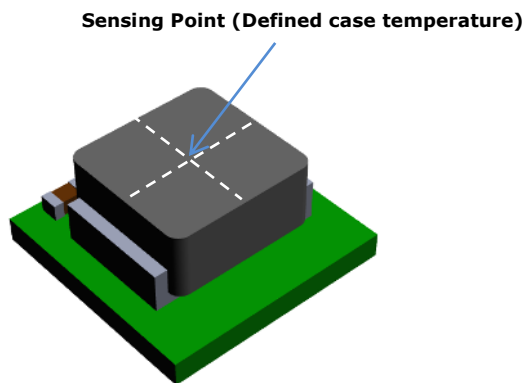

**Figure 29. Case Temperature Sensing Point**

**REFLOW PARAMETERS:**

Lead-free soldering process is a standard of electronic products production. Solder alloys like Sn/Ag, Sn/Ag/Cu and Sn/Ag/Bi are used extensively to replace the traditional Sn/Pb alloy. Sn/Ag/Cu alloy (SAC) is recommended for this power module process. In the SAC alloy series, SAC305 is a very popular solder alloy containing 3% Ag and 0.5% Cu and easy to obtain. Figure 30 shows an example of the reflow profile diagram. Typically, the profile has three stages. During the initial stage from room temperature to 150°C, the ramp rate of temperature should not be more than 3°C/sec. The soak zone then occurs from 150°C to 200°C and should last for 60 to 120 seconds. Finally, keep at over 217°C for 60 seconds limit to melt the solder and make the peak temperature at the range from 240°C to 250°C. It is noted that the time of peak temperature should depend on the mass of the PCB board. The reflow profile is usually supported by the solder vendor and one should adopt it for optimization according to various solder type and various manufacturers' formulae.

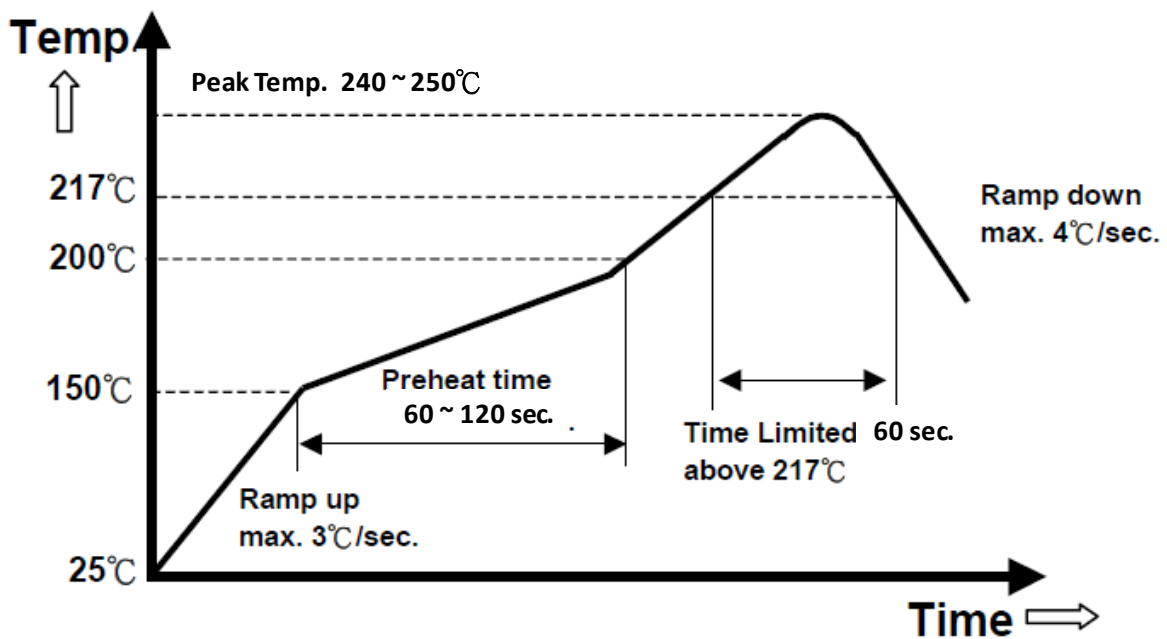
**FIG.30 Recommendation Reflow Profile**

**PACKAGE OUTLINE DRAWING:**

Unit: mm

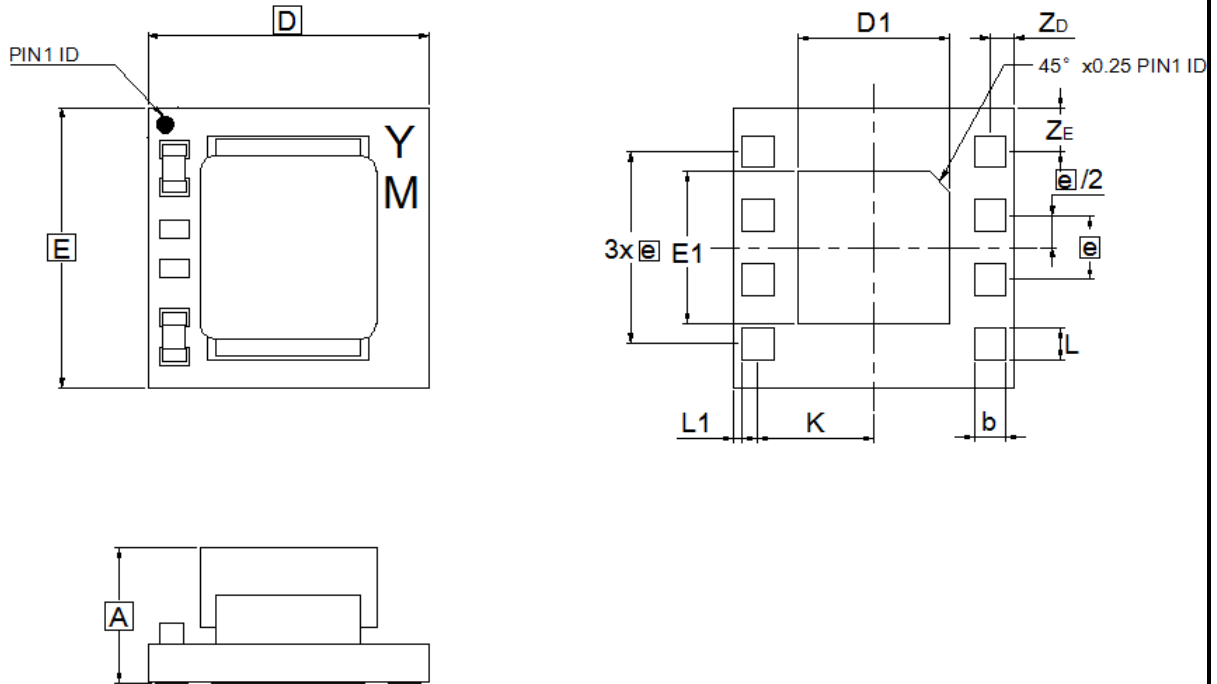

DIM	MILLIMETERS		
	MIN	NOM	MAX
A	1.40	1.55	1.70
D	3.4	3.5	3.6
D1	1.80	1.9	2.00
E	3.4	3.5	3.6
E1	1.80	1.9	2.00
K	1.40	1.45	1.50
e	0.75	0.80	0.85
b	0.30	0.40	0.50
L	0.30	0.40	0.50
L1	0.05	0.10	0.15
ZD	0.20	0.30	0.40
ZE	0.45	0.55	0.65

**LAND PATTERN REFERENCE:**

Unit: mm

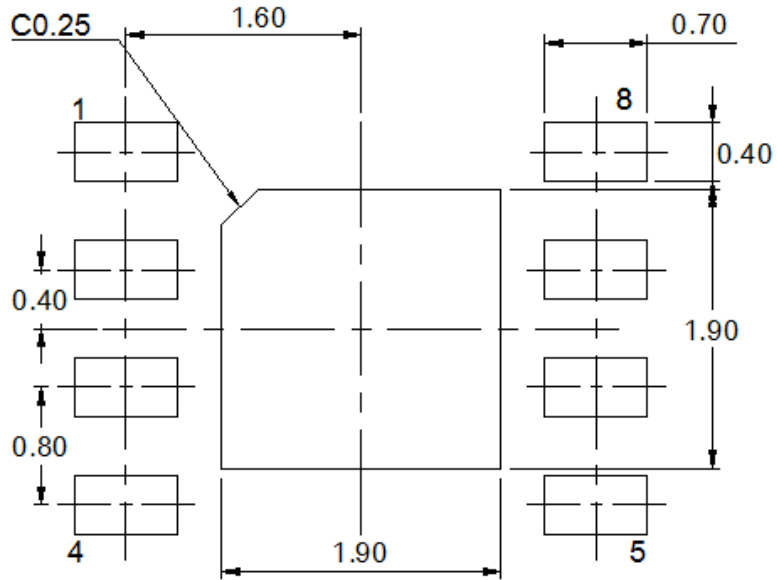
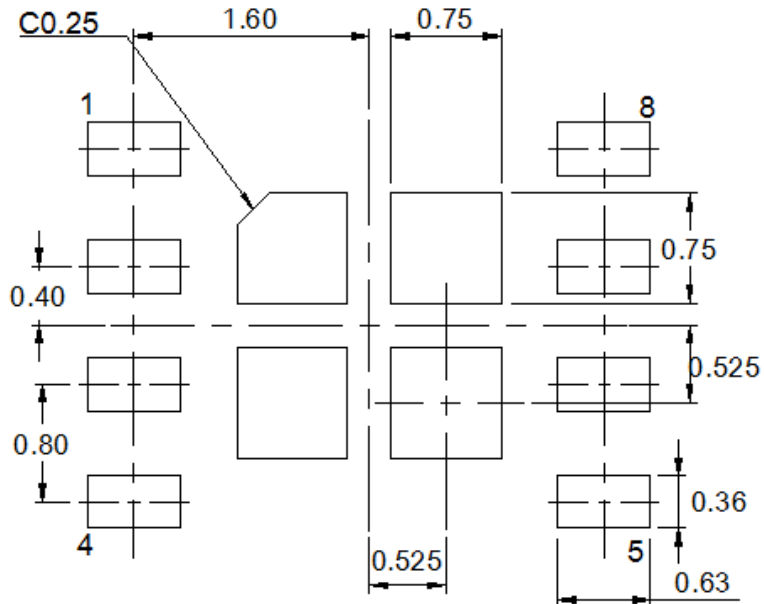
**RECOMMENDED LAND PATTERN**

**RECOMMENDED STENCIL PATTERN  
 BASED ON 0.1mm THICKNESS STENCIL**

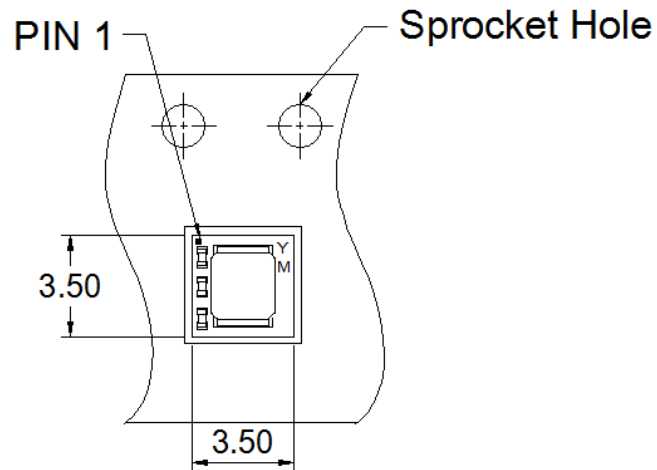

**PACKING REFERENCE:**

Unit: mm

**Package In Tape Loading Orientation**

**Tape Dimension**

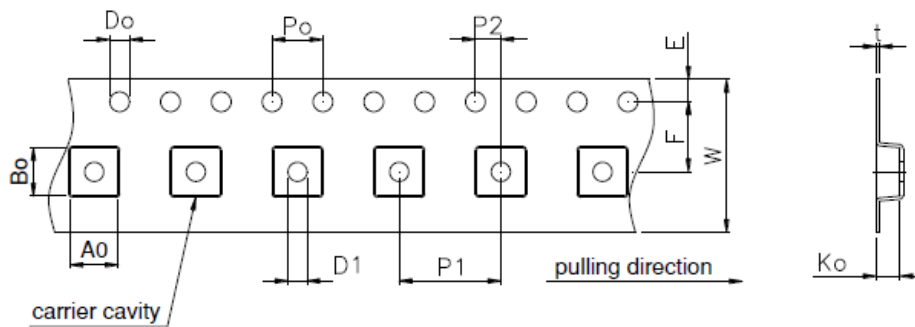
Unit:mm



A0	3.8 ± 0.10	E	1.75 ± 0.10
B0	3.8 ± 0.10	K0	1.88 ± 0.10
F	5.50 ± 0.05	P0	4.00 ± 0.10
W	12.00 ± 0.30	P1	8.00 ± 0.10
D0	φ1.55 ± 0.05	P2	2.00 ± 0.05
D1	φ1.50 ± 0.10	t	0.25 ± 0.10

**PACKING REFERENCE: (Cont.)**

Unit: mm

**Reel Dimension**

**Peel Strength of Top Cover Tape**

The peel speed shall be about 300mm/min.

The peel force of top cover tape shall be between 0.1N to 1.3N

**REVERSION HISTORY:**

<b>Date</b>	<b>Revision</b>	<b>Changes</b>
2014.06.24	00	Release the preliminary specification.
2014.07.09	01	Update application and POD drawing.
2014.09.17	02	Update Electrical specifications and packing information.
2014.11.24	03	Adjust Fig. sequence.
2014.12.11	04	Update land pattern reference.
2014.12.31	05	Update uPOL module to LDS module.
2015.02.26	06	Update POD and PIN 1 drawing.
2015.06.05	07	Update recommendation layout and schematic Change pin 6 define to N.C.
2015.06.24	08	Add REFLOW PARAMETERS
2015.09.01	09	Add constant on-time control in general description.
2015.11.17	10	Change recommendation reflow profile
2016.01.25	11	Modify outline drawing.
2016.06.28	12	Modify land pattern reference
2017.03.24	13	Add PGOOD sink current spec