



SERIES: HSE01 | **DESCRIPTION:** HEAT SINK

FEATURES

- extruded design
- thermal pad option
- aluminum alloy



MODEL

	thermal pad	thermal resistance ¹				power dissipation ¹ @ 75°C ΔT, nat conv [W]
		@ 75°C ΔT, nat conv [°C/W]	@ 1 W, nat conv [°C/W]	@ 1 W, 200 LFM [°C/W]	@ 1 W, 400 LFM [°C/W]	
HSE01-193175	no	25.44	29.0	9.2	5.8	2.95
HSE01-193175P	yes	25.44	29.0	9.2	5.8	2.95

Note: 1. See performance curves for full thermal resistance details.

THERMAL PAD SPECIFICATIONS

parameter	test method/conditions/description	min	typ	max	units
material	double sided silicone adhesive				
color	white				
thickness			0.2		mm
specific gravity			1.9		
dielectric breakdown voltage	at 100 μm		300		kV
thermal conductivity			0.7		W/m*K
thermal resistance	at 100 μm, 20 psi		1.82		cm ² *K/W

PERFORMANCE CURVES

Power [W]	Heatsink Temperature Rise Above Ambient (ΔT = T _{hs} - T _a) [°C]		
	Natural Conv.	200 LFM	400 LFM
0	0	0	0
1	29.0	9.2	5.8
2	54.7	18.5	11.8
3	77.0	27.7	17.7
4	97.3	36.9	23.5
5	117.3	45.9	29.1

T_{hs}: "hot spot" temperature measured on the heatsink
T_a: ambient temperature

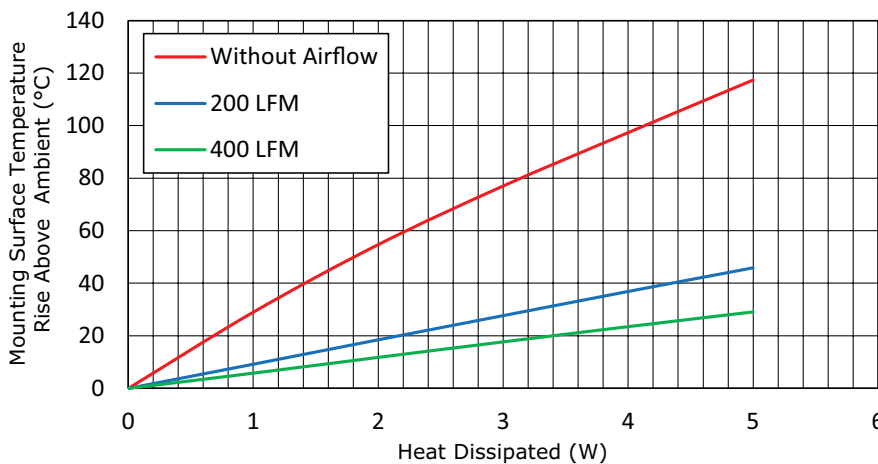

MECHANICAL DRAWING

units: mm
tolerance: ±0.5 mm

MATERIAL	AL 6063-T5
FINISH	blue anodized
WEIGHT	6.9 g

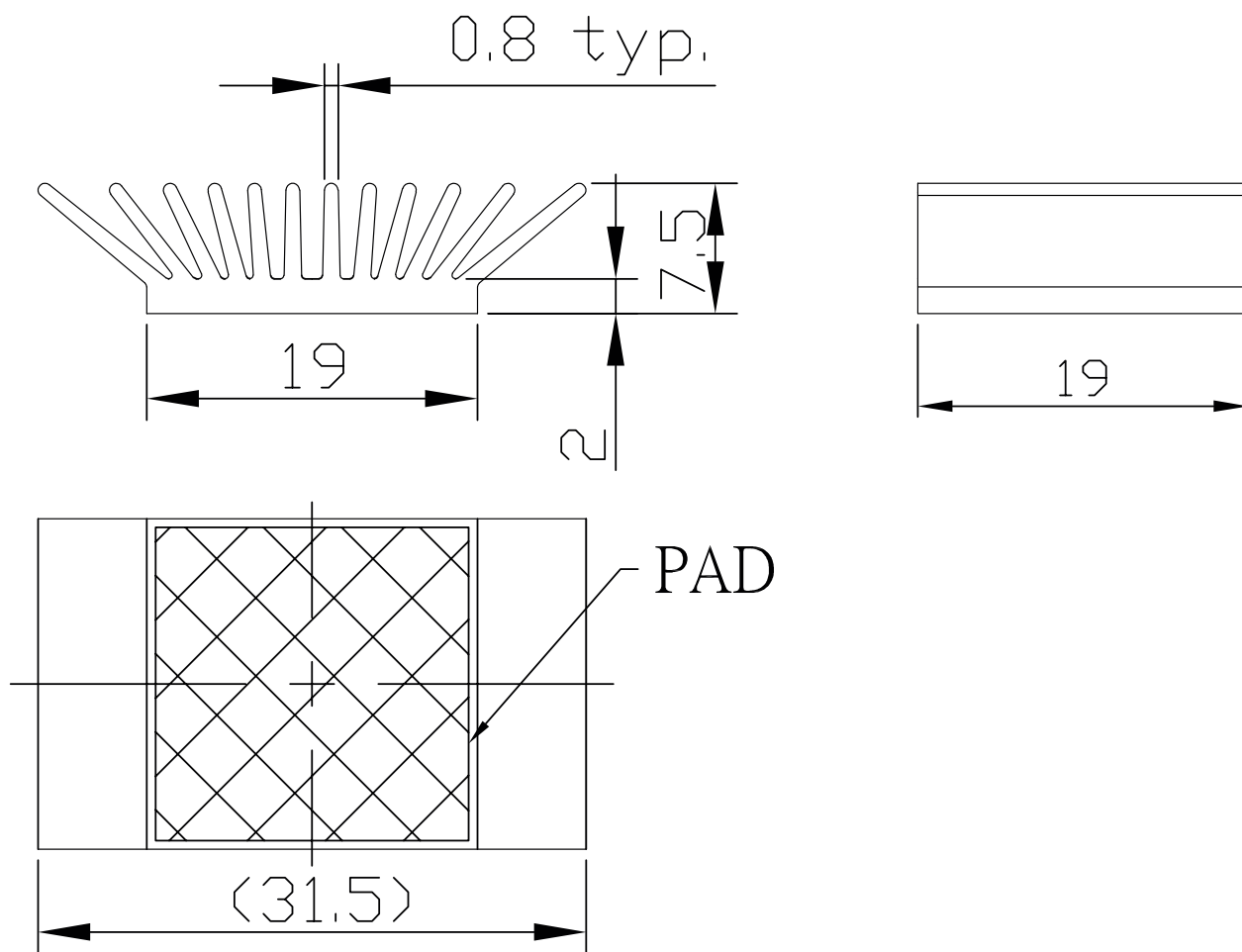

REVISION HISTORY

rev.	description	date
1.0	initial release	04/20/2022
1.01	logo, datasheet style update	08/05/2022

The revision history provided is for informational purposes only and is believed to be accurate.



CUI Devices offers a one (1) year limited warranty. Complete warranty information is listed on our website.

CUI Devices reserves the right to make changes to the product at any time without notice. Information provided by CUI Devices is believed to be accurate and reliable. However, no responsibility is assumed by CUI Devices for its use, nor for any infringements of patents or other rights of third parties which may result from its use.

CUI Devices products are not authorized or warranted for use as critical components in equipment that requires an extremely high level of reliability. A critical component is any component of a life support device or system whose failure to perform can be reasonably expected to cause the failure of the life support device or system, or to affect its safety or effectiveness.

cuidevices.com