

**Order Number  
63828-1500**

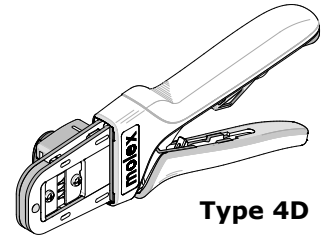

**Application Tooling Specification**



**Type 4D**

**FEATURES**

- A full cycle ratcheting hand tool ensures complete crimps
- Ergonomic soft grip handles for comfortable crimping
- A precision user-friendly terminal locator wire stop holds terminals in the proper crimping position
- Right- and left-handed applications
- This tool is IPC/WHMA-A-620 Class 2 compliant (see pages 2 and 3)
- This tool is RoHS compliant; however, RoHS compliance is not required

**SCOPE**

**Products:** Standard .093" Pin and Socket Crimp Terminals, 22 AWG Stranded Wire.

Terminal Series No.	◇ Terminal Order No.		Wire Size		✦ Insulation Diameter				Strip Length	
					IPC/WHMA-A-620 (1)		Terminal (2)			
	Loose Piece	Reel (3)	AWG	mm <sup>2</sup>	mm	In.	mm	In.	mm	In.
2273	02-09-1123	02-09-1122	22	—	1.25-2.50	.049-.098	1.25-2.50	.049-.098	4.00-5.00	.160-.200

✦ **Insulation Diameter Notes**  
**(1)** Insulation diameter range for optimum (IPC/WHMA-A-620 Class 2) insulation crimps. Use tool profile specified on page 3.  
**(2)** Insulation diameter range for the terminal product design.  
 ◇ **Terminal Order No. Note**  
**(3)** Reeled terminals must be properly cut from the reel. See Terminal Cut-Off Specifications on page 2.

**DEFINITION OF TERMS**

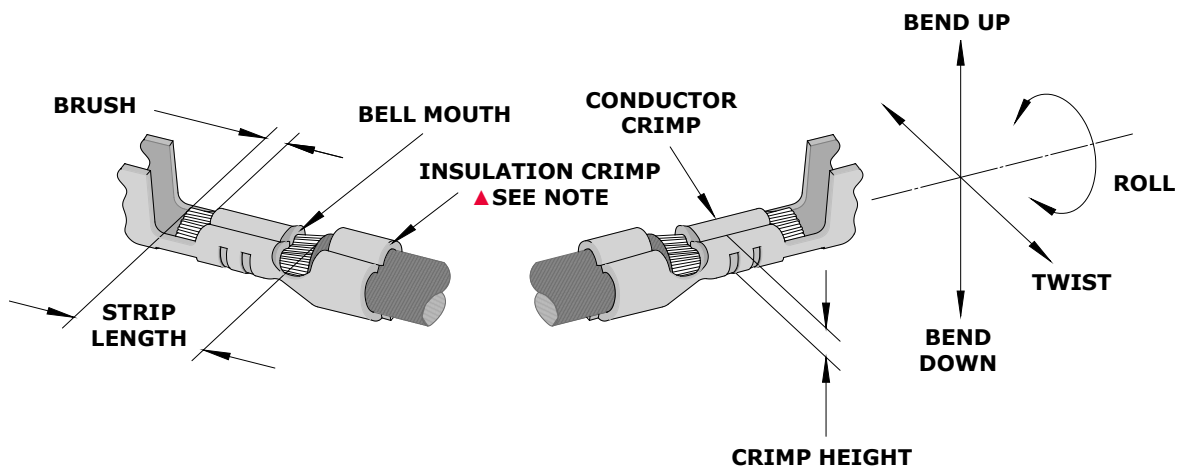

**▲ Insulation Crimp Note**

Due to the terminal's insulation grip design or insulation diameter range, this tool uses the overlap form geometry in the insulation punch. This produces an overlap insulation crimp (A-620-compliant). Although the insulation punch profile may appear lopsided, this is a normal condition for this tool. See figure to the right. Some tools with multiple crimp pockets may not have the overlap profile on all pockets.

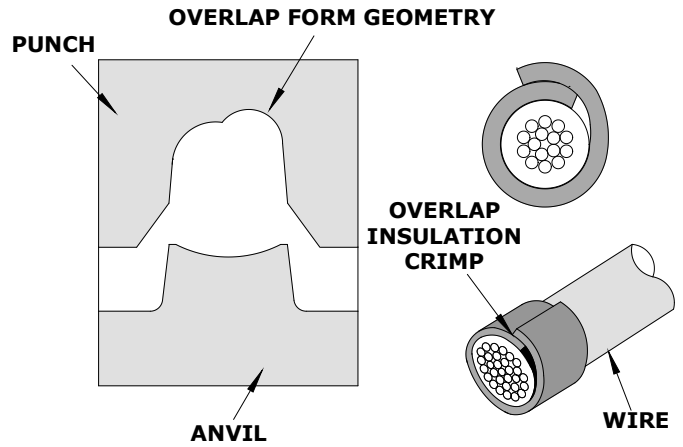

**TERMINAL CUT-OFF SPECIFICATIONS**

This hand tool operates best with loose-piece terminals. If reeled terminals are used, they must be cut from the carrier strip as specified below:

Terminal Series No.	Reeled Terminal Order No.	Cut-Off Dimension "X"	
		mm	In.
2273	02-09-1122	3.61 +/- 0.08	.142 +/- .003

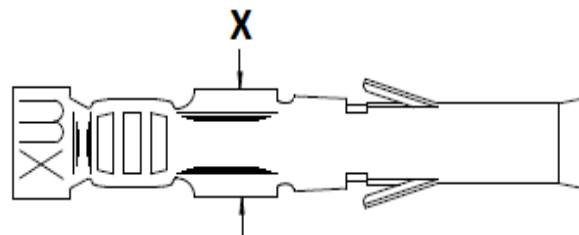

**2273 SERIES**

## Hand Crimp Tool for .093" Pin and Socket Crimp Terminals

After crimping, the crimped terminal should measure as follows:

Terminal Series No.	Wire Size		Conductor				Pull Force Minimum	
			Crimp Height		Crimp Width (Ref)			
	AWG	mm <sup>2</sup>	mm	In.	mm	In.	N	Lb.
2273	22	—	1.08-1.14	.043-.045	1.80	.071	44.5	10

To achieve IPC/WHMA-A-620 Class 2 insulation crimps, use the appropriate tool profile for the insulation diameter:

Terminal Series No.	Wire Size		UL Style (Ref)	Insulation Diameter Range		Insulation Crimp (Ref)				Tool Profile		
						Crimp Height		Crimp Width				
	AWG	mm <sup>2</sup>		mm	In.	mm	In.	mm	In.	A	B	C
2273	22	—	UL1007	1.55-1.85	.061-.073	2.65	.104	2.00	.079	X		
			UL1015	2.10-2.50	.083-.098	2.73	.108	2.58	.102		X	
			UL1061	1.25-1.55	.049-.061	2.24	.088	1.87	.074			X

Crimp attribute specifications:

Terminal Series No.	Wire Size		Bell Mouth		Brush		Bend Up	Bend Down	Twist	Roll
	AWG	mm <sup>2</sup>	mm	In.	mm	In.				
2273	22	—	0.20-0.50	.008-.020	0.30-1.00	.012-.040	3°	3°	4°	8°

### Tool Qualification Notes

- (Ref) means that the dimension provided is approximate because of the wide range of wires, conductor stranding, insulation diameter and insulation hardness.
- An occasional conductor crimp height measurement should be performed. It must lie between the minimum and maximum crimp height specification.
- Pull force should be measured with no influence from the insulation crimp. To ensure this, strip the wire long enough so the terminal insulation grips do not contact the wire insulation.

### Notes

- This tool should only be used for the terminals and wire gauges specified on this sheet.
- Variations in tools, terminals, wire stranding and insulation types may affect crimp height.
- This tool is intended for AWG conductor sizes. It may not give good insulation crimp support for insulation sizes outside of the specified range.
- Molex does not repair hand tools. See warranty on page 7. The replacement parts listed are the only parts available for repair. If the handles or crimp tooling become damaged or worn, a new tool must be purchased.
- Conductor crimp height should be used as the final criterion for an acceptable crimp. Refer to Molex Quality Crimping Handbook 63800-0029 for additional information on crimping and crimp testing.
- Molex does not certify hand crimp tools.

## OPERATION



**CAUTION:** Crimp only the Molex terminals listed in the scope for this tool. Do not crimp hardened objects as damage can occur to the tool frame or crimp dies.

Open the tool by squeezing the handles together. At the end of the closing stroke, the ratchet mechanism will release the handles and the hand tool will spring open. See Figure 1.

### Crimping Terminals

1. Select the desired terminal listed in the preceding charts.
2. Make sure the center of the locator is in the down position. With the locator attached, push the locator button on the back of the hand tool to bring the locator forward through the tooling. See Figure 2.
3. While holding the locator button in, load the terminal into the proper nest opening in the locator based on the wire insulation diameter markings on the crimp jaws. See Figure 3.

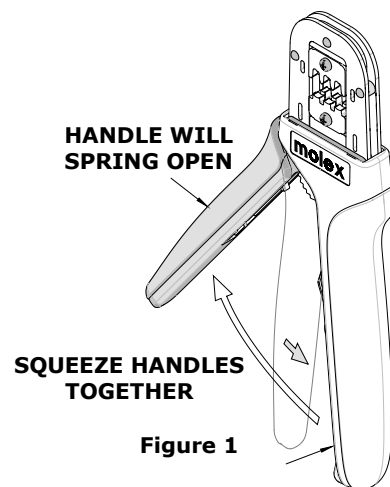

Figure 1

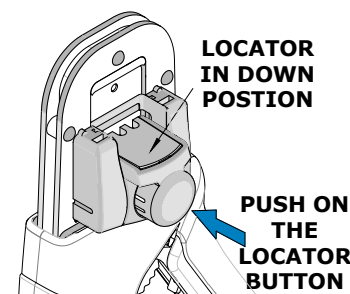

Figure 2

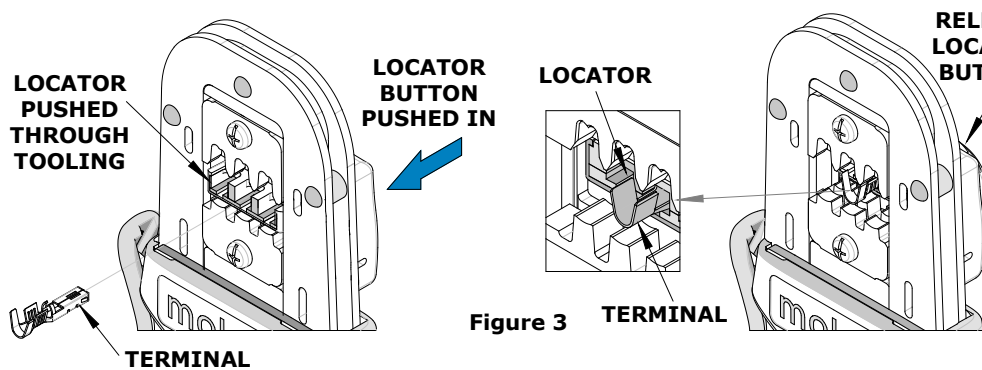

Figure 3

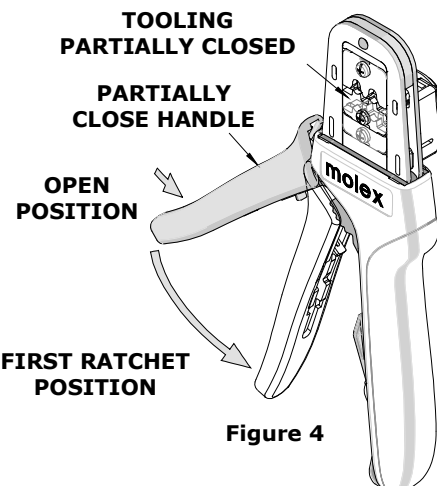

Figure 4

4. Release the locator button, allowing the locator to return to the crimping position.
5. Close the tool handle until the first ratchet position engages. See Figure 4.
6. Insert the properly stripped wire through the terminal and against the wire stop. See Figure 5.
7. Crimp the terminal by squeezing the tool handles until the ratchet mechanism cycle has been completed. Release the handles to open the jaws.

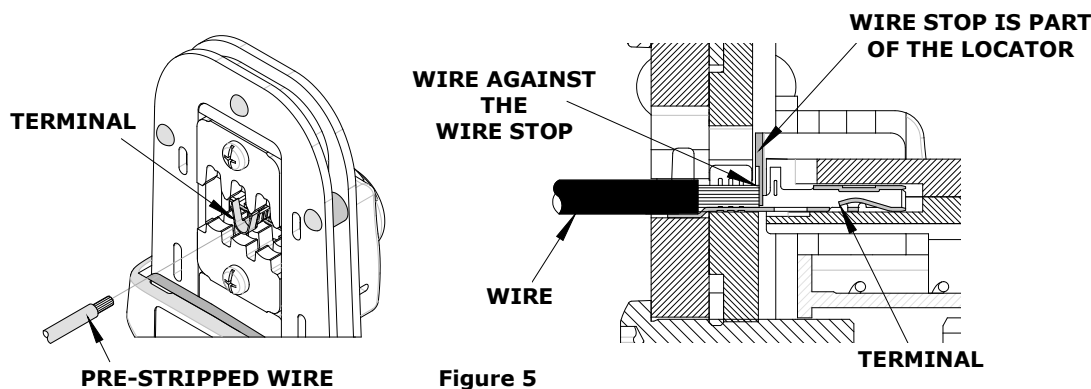

Figure 5

**Note:** The tamper-proof ratchet action will not release the tool until it has been fully closed.

8. Remove the crimped terminal from the terminal locator by pulling on the wire.
9. Visually inspect the crimped terminal for proper crimp location.
10. On some large O.D. wires, it may not be possible to insert the wire with the tool partially closed. Those wires should be inserted with the hand tool in the open position. Insert the wire above the terminal in the punch and against the wire stop then close the tool. See Figure 6.

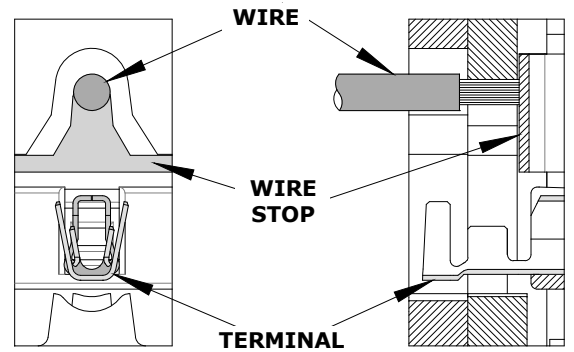

Figure 6

### Locator Replacement

See the parts list on the last page of this document for the proper locator order number. Follow the steps below to replace the locator:

1. Open the hand crimp tool.
2. Squeeze gently on the lower area shown in Figure 7A with your thumb and index finger. The lower tabs of the locator should disengage from the hand tool.
3. Lift and pull away from the hand tool. The top locator hooks should slip out of the top slots easily. See Figure 7A.
4. To reinstall the new locator, make sure the hand tool is in the open position.
5. Press the center of the locator down as far as it will go as shown in Figure 7B.
6. Holding onto the lower part of the locator with your thumb and index finger, insert the locator's top hooks into the hand tool top slots.
7. Rotate the locator down, and press the lower tabs into the two bottom slots of the hand tool. To secure the locator into place, the lower tabs must snap into place on the hand tool frame.

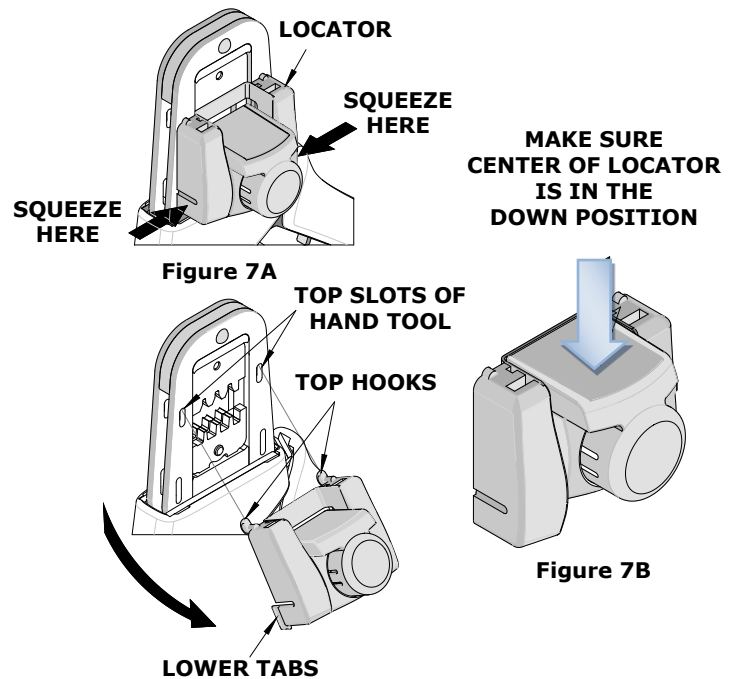

Figure 7A

Figure 7B

### Right- or Left-Handed Operation

This hand tool can be converted from a right-handed application to a left-handed application. It is necessary to reverse the tooling if using the left-handed application along with the locator. Follow the steps below:

1. The locator must be removed before reversing the tooling.
2. Remove the M3 BHCS that is holding the upper tooling.
3. Flip the upper tooling to the opposite side, and replace the M3 BHCS. Make sure the small markings on the front and back of the hand tool frame match up and are on the outside of the hand tool frame. See Figures 8 and 9.
4. Do the same thing with the lower tooling, and tighten the M3 screws. Be sure the small markings line up.
5. Reinstall the locator by following the instructions in the locator replacement section.

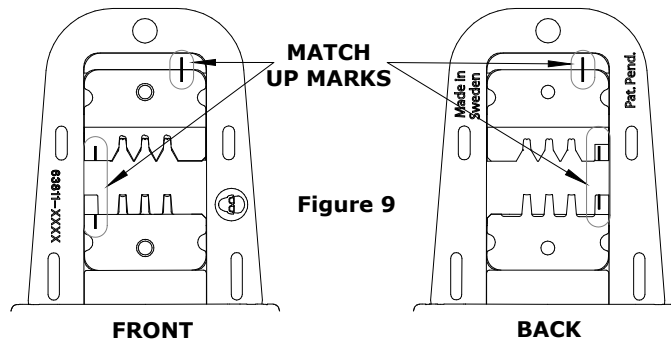
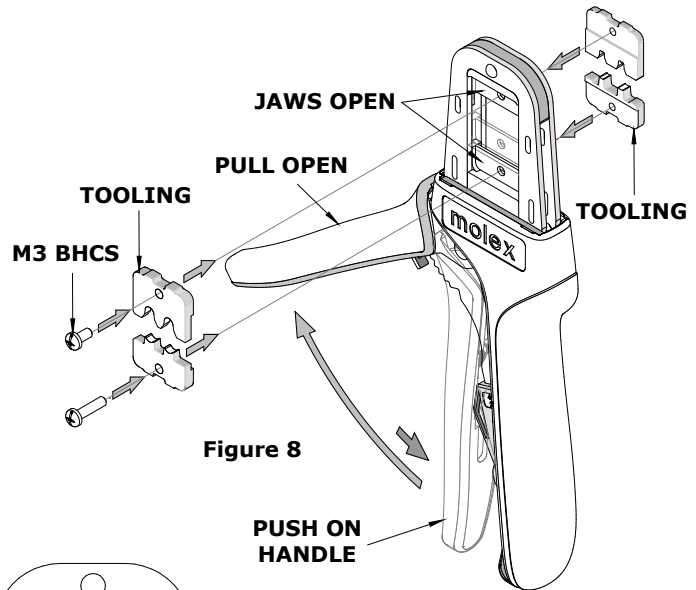

### MAINTENANCE

It is recommended that each operator of the tool be made aware of and responsible for the following maintenance steps:

1. Remove dust, moisture and other contaminants with a clean brush or a soft, lint-free cloth.
2. Do not use any abrasive materials that could damage the tool.
3. Make certain all pins, pivot points and bearing surfaces are protected with a thin coat of high-quality machine oil. See Figure 10. Do not oil excessively. The tool was engineered for durability, but like any other equipment, it needs cleaning and lubrication for a maximum service life of trouble-free crimping. Light oil such as 30 weight automotive oil used at the oil points every 5,000 crimps or 3 months will significantly enhance the tool life.
4. Wipe excess oil from hand tool, particularly from the crimping area. Oil transferred from the crimping area onto certain terminations may affect the electrical characteristics of an application.
5. When the tool is not in use, keep the handles closed to prevent objects from becoming lodged in the crimping dies, and store the tool in a clean, dry area.

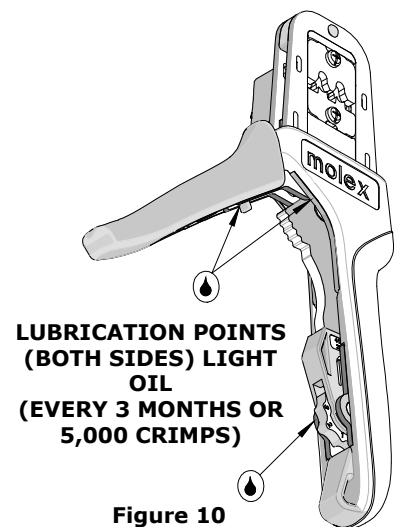

### Miscrimps or Jams

Should this tool ever become stuck or jammed in a partially closed position, **do not force the handles open or closed**. The tool will open easily by pressing up on the ratchet release lever in the movable handle. See Figure 11.

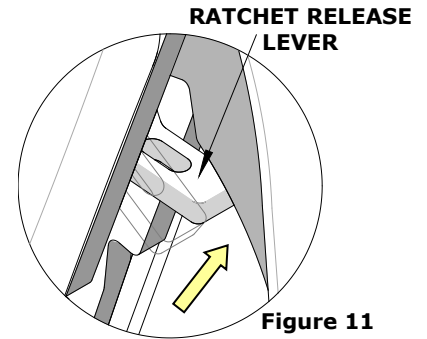

Figure 11

### How to Adjust Tool Preload (See Figure 12)

Hand tool frame preload is factory preset to ensure crimp quality. It may be necessary over the life of the tool to adjust tool handle preload force. Listed below are the steps required to adjust the crimping force of the hand tool to obtain proper crimp conditions:

1. Open the hand tool.
2. Close the handle 2 ratchet clicks.
3. Hold the hand tool in the palm of your hand as shown in Figure 12. Using your index finger, squeeze the link toward the top of the hand tool frame. This will release the preload adjustment wheel.
4. Rotate the setting wheel counterclockwise (CCW) to increase handle force. The numbers will display higher. To decrease handle force, rotate the setting wheel clockwise (CW).
5. Release the link to lock the setting wheel in place.
6. Check the crimp specifications or conduct a pull test after tool handle preload force is adjusted.

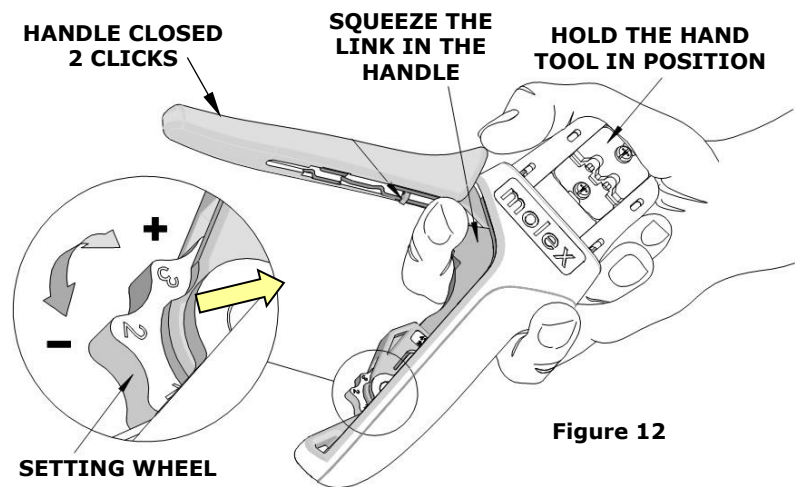

Figure 12

### Warranty

This tool is for electrical terminal crimping purposes only. This tool is made of the best quality materials. All vital components are long-life tested. All tools are warranted to be free of manufacturing defects for a period of 30 days. Should such a defect occur, Molex will repair or exchange the tool free of charge. This repair or exchange will not be applicable to altered, misused or damaged tools. This tool is designed for hand use only. Any clamping, fixturing or use of handle extensions voids this warranty.

**CAUTION:** Molex crimp specifications are valid only when used with Molex terminals and tooling.

### CAUTIONS:

1. Manually powered hand tools are intended for low-volume use or field repair. This tool is **NOT** intended for production use. Repetitive use of this tool should be avoided.
2. Insulated rubber handles are not protection against electrical shock.
3. Wear eye protection at all times.
4. Use only the Molex terminals specified for crimping with this tool.

## PARTS LIST

Item Number	Order Number	Description	Quantity
REF	63828-1500	Hand Crimp Tool	Figure 13
1	63828-1575	Locator Assembly (red)	1
2	63810-0104	Spring, Return	1
3	63810-0105	Spring, Ratchet	1

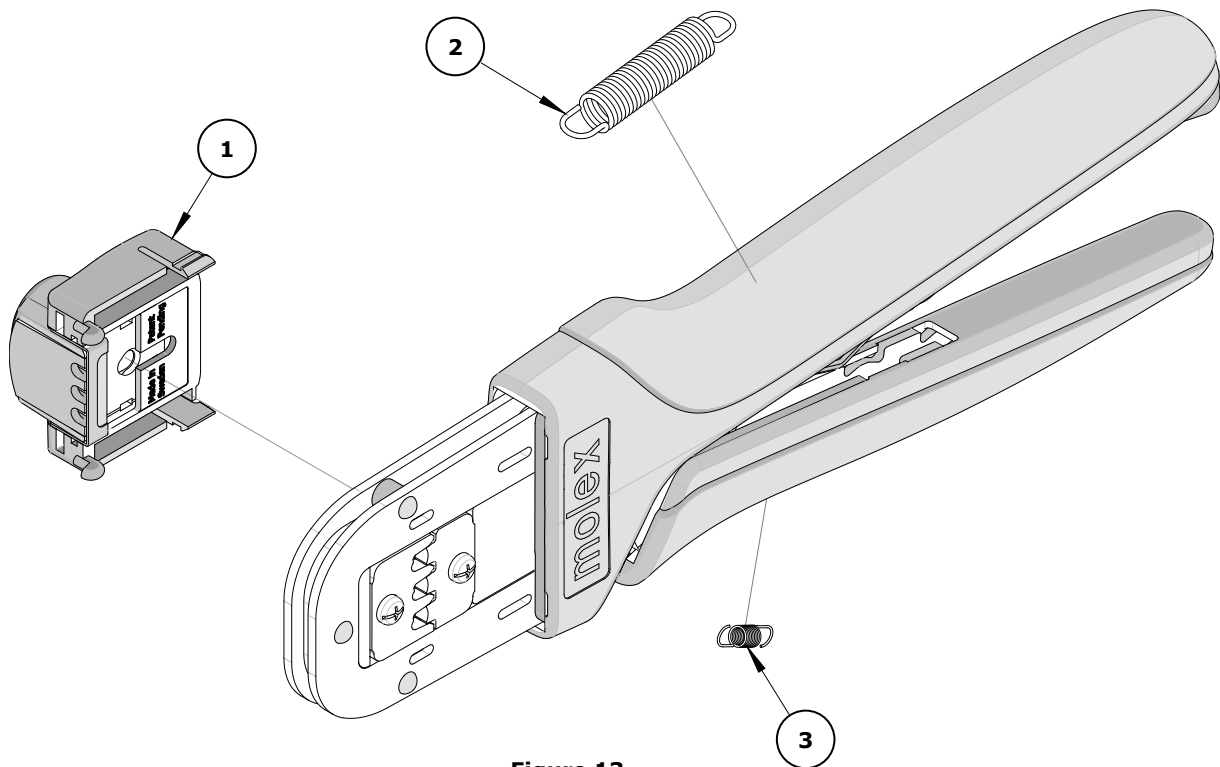

Figure 13

### Application Tooling Support

**Phone:** (402) 458-TOOL (8665)

**E-Mail:** [toolingsupport@molex.com](mailto:toolingsupport@molex.com)

**Website:** [www.molex.com/applicationtooling](http://www.molex.com/applicationtooling)

Molex is a registered trademark of Molex, LLC in the United States of America and may be registered in other countries; all other trademarks listed herein belong to their respective owners.