

# **Dual Mode (WPC and PMA) Integrated Wireless Receiver Power Supply**

---



---

The bq51221EVM-520 (PWR520-001) wireless power receiver evaluation kit (EVM) from Texas Instruments is a high performance, easy-to-use development kit for the design of wireless power solutions. It helps designers to evaluate the operation and performance of the bq51221 IC, (also, this EVM can be used to evaluate the bq51021 IC, a WPC-only receiver) a secondary-side receiver device for wireless power transfer in portable applications. The bq51221 device is a fully contained wireless power receiver capable of operating in both the WPC and PMA protocols which enables a system to not be confined to one standard. The bq51221 provides a single stage power conversion while integrating the digital control and communication. The bq51221 complies with the WPC v1.1 and PMA communication protocol. The kit enables designers to speed up the development of their end-applications.

## **Contents**

1	Introduction .....	3
2	Considerations with this EVM .....	3
3	Modifications.....	4
4	Recommended Operation Condition .....	4
5	Equipment and EVM Setup.....	5
	5.1 Schematic.....	5
	5.2 Connector and Test Point Descriptions .....	6
	5.3 Jumpers/Switches .....	6
	5.4 Test Point Descriptions .....	7
	5.5 Pin Description of the IC .....	7
6	Test Procedure .....	8
	6.1 Definition .....	8
	6.2 Recommended Test Equipment .....	8
	6.3 Equipment Setup.....	8
	6.4 Procedure .....	9
7	Test Results .....	11
	7.1 Steady State Operation with bq2425x Charger .....	11
	7.2 Load Step .....	12
	7.3 TS Control Function.....	14
	7.4 Efficiency Data.....	15
	7.5 AD Insertion and Removal .....	15
	7.6 Thermal Performance.....	16
8	Dual Mode Coil Design Consideration.....	17
	8.1 Shielding.....	17
	8.2 Receiver Detection: Attraction and Alignment.....	17
	8.3 Inductor Value .....	17
9	Layout and Bill of Materials .....	18
	9.1 bq5122x Traces .....	18
	9.2 Layout Guidelines .....	18
	9.3 Printed-Circuit Board Layout Example .....	18
	9.4 bq51221EVM-520 Layout .....	20
	9.5 Bill of Materials .....	23

## **List of Figures**

1	bq51221EVM-520 Schematic .....	5
2	bq51221 in Steady State Operation with bq24250EVM.....	11
3	Load Step (PMA) with VIN_DPM .....	12
4	Load Step (WPC).....	13
5	TS Control Function .....	14
6	System Efficiency versus Output Current .....	15
7	AD Insertion and Removal .....	15
8	Thermal Image in WPC Transmitter (1000-mA Load) .....	16
9	Thermal Image in PMA Transmitter (1000-mA Load) .....	16
10	Dual Mode Coil Example .....	17
11	bq51221EVM-520 Layout Example .....	19
12	bq51221EVM-520 Top Assembly .....	20
13	bq51221EVM-520 Layer 1 .....	20
14	bq51221EVM-520 Layer 2 .....	21
15	bq51221EVM-520 Layer 3 .....	21
16	bq51221EVM-520 Layer 4 .....	22

**List of Tables**

1	bq51221EVM-520 Electrical Performance Specifications .....	4
2	Pin Description .....	7
3	bq51221EVM-520 Rev. B Bill of Materials .....	23

## 1 Introduction

The bq5122x is an advanced, flexible, secondary-side device for wireless power transfer in portable applications. The bq5122X devices integrate an ultra-low-impedance synchronous rectifier, a very high efficiency post regulator, digital control, and accurate voltage and current loops. The bq5122X devices provide the AC/DC power conversion while integrating the digital control required. The IC complies with both WPC v1.1 and PMA communication protocol.

Together with the bq50xxx primary-side controller or any type-1 PMA transmitter, the bq5122X enables a complete contactless power transfer system for a wireless power supply solution. By utilizing near-field inductive power transfer, the secondary coil embedded in the mobile device can pick up the power transmitted by the primary coil. The voltage from the secondary coil is then rectified and regulated to be used as a power supply for down-system electronics. Global feedback is established from the secondary to the primary in order to control the power transfer process.

In WPC, the system communication is digital - packets are transferred from the secondary to the primary. Differential bi-phase encoding is used for the packets. The bit rate is 2 Kbits/s. Various types of communication packets have been defined. These include identification and authentication packets, error packets, control packets, power usage packets and efficiency packets, among others.

A PMA-compliant receiver communicates based on continuous transmission of signals from the receiver to the transmitter. The PMA system defines six different communications symbols. These are PMA INC, PMA DEC, PMA NoCHG, PMA EOC, PMA MsgBit and PMA TBD (proprietary for future use). The PMA receiver will transmit these signals back to back with no gaps between them to control the operation point. Each PMA receiver will have a unique PMA RXID, transmitted in the RXID message. Note that the first build of these EVMs do not have RX ID implemented.

## 2 Considerations with this EVM

The bq51221EVM-520 evaluation module (PWR520-001) demonstrates the receiver portion of the wireless power system. This receiver EVM is a complete receiver-side solution that produces 5-W output power at up to 1-A load with adjustable output voltage.

- The receiver can be used in any number of low-power battery portable devices as a power supply for a battery charger. With contact-free charging capability, no connections to the device are needed.
- Highly integrated wireless power receiver solution
  - Ultra efficient synchronous rectifier
  - Very high efficiency post regulator
  - WPC v1.1- and PMA-compliant communication and control
  - Only one IC required between RX coil and DC output
- Programmable output voltage to optimize performance for any application
- Adaptive communication current limit (CM\_ILIM) for robust communication in WPC mode
- Supports 20-V max input
- Low-power dissipative over voltage clamp
- Over voltage, over current , over temperature protection for both PMA and WPC modes
- Low-profile, external pick-up coil
- Frame is configured to provide correct receiver to transmitter spacing
- Room above coil for testing with battery, key for Foreign Object Detection (FOD) tuning.
- Options to adjust the input current limit and output voltage using resistor or I2C
- Flexibility for FOD tuning
- Adjustable resistor that can be used to set RFOD
- Temperature sensing can be adjusted using external resistors
- Micro-USB connector for adapter testing configuration
- I2C connector (USB-TO-GPIO “HPA172” kit for I2C communication through computer is required)
- $\overline{WPG}$  LED indicator (turns on as the VOUT goes high)

### 3 Modifications

See the bq51221 data sheet ([SLUSBS9](#)) when changing components. To aid in such customization of the EVM, the board was designed with devices having 0402 and 0603 or larger footprints. A real implementation likely occupies less total board space.

Note that changing components can improve or degrade EVM performance.

### 4 Recommended Operation Condition

[Table 1](#) provides a summary of the bq51221EVM-520 performance specifications. All specifications are given for an ambient temperature of 25°C.

**Table 1. bq51221EVM-520 Electrical Performance Specifications**

Parameter		Test Condition	MIN	TYP	MAX	Unit
V <sub>RECT</sub>	Rect voltage range		4		10	V
I <sub>AD_EN_SINK</sub>	Sink current				1	mA
I <sub>IN</sub>	Input current range				1.5	A
I <sub>OUT</sub>	Output current range	Current limit programming range			1.5	A
V <sub>OUT(REG)</sub>	Programmable Output Voltage <sup>(1)</sup>	POUT = 5 W	4.5		8	V
F <sub>s</sub>	Switching Frequency	WPC	110		205	kHz
		PMA	235		275	
T <sub>J</sub>	Junction Temperature			125		°C

<sup>(1)</sup> The output voltage can be adjusted using I2C or the VIREG and VOREG resistors. Also the coil needs to be changed for different voltage for optimal operation of the EVM.

## 5 Equipment and EVM Setup

### 5.1 Schematic

Figure 1 illustrates the bq51221 EVM-520 schematic.

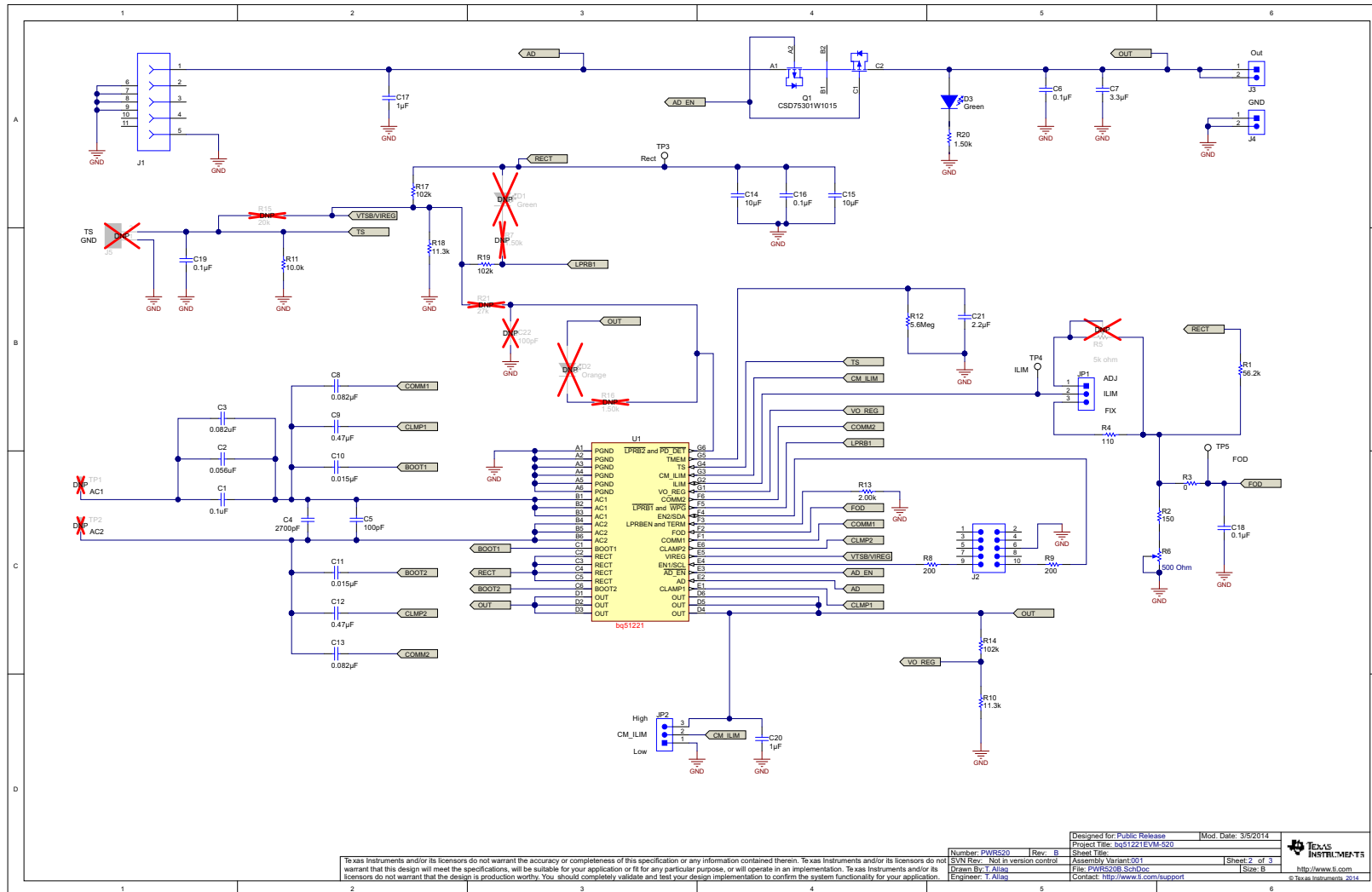

Figure 1. bq51221 EVM-520 Schematic

## 5.2 Connector and Test Point Descriptions

The connections points are described in the following paragraphs:

### J1 – AD External Adapter Input

Power can be provided to simulate an external adapter applied to the receiver in the bq51221EVM-520 (PWR520-001).

### J2 – Programming Connector

This connector is populated and is used for I2C communication using the USB-TO-GPIO “HPA172” kit.

### J3 – Output Voltage

Output voltage in wireless power mode up to 1 A; the adapter option is also supported in this PWR520-001.

### J4 –GND

Ground return

### J5 – TS and Return Connector

External connection for temperature sense resistor, see the bq51221 data sheet ([SLUSBS9](#)) for additional information. Not populated in this spin.

## 5.3 Jumpers/Switches

The control jumpers and switches are described in the following paragraphs:

### JP1– ILIM - Fix or ADJ

Max output current is set by ILIM pin. In the FIX position, the current is set to a fixed value of R4. In the ADJ position current is set by R5. Note that R5 is not installed in this EVM.

### JP2 – CM\_ILIM

Enables the CM\_ILIM feature when pulled low and disables when pulled up (High).

## 5.4 Test Point Descriptions

The test points are described in the following paragraphs:

### TP1 & 2 – AC1 and AC2 Inputs

These are not populated, they can be used for measuring AC voltage applied to the EVM from the receiver coil.

### TP3– Rectified Voltage

The input AC voltage is rectified into unregulated DC voltage (RECT); additional capacitance is used to filter the voltage before the regulator.

### TP4– ILIM

Programming pin for over current limit protection, pin G2 of the IC.

### TP5 – FOD

Input for rectified power measurement for Foreign Object Detection feature in WPC, pin F2 of the IC. FOD pin for the bq51221.

## 5.5 Pin Description of the IC

**Table 2. Pin Description**

Pin Number (WCSP)	bq5122x
A1, A2, A3, A4, A5, A6	PGND
B1, B2, B3	AC1,
B4, B5, B6	AC2,
C1	BOOT1
C2, C3, C4, C5	RECT
C6	BOOT2
D1, D2, D3, D4, D5, D6	OUT
E1	CLAMP1
E2	AD
E3	AD_EN
E4	SCL
E5	VIREC
E6	CLAMP2
F1	COMM1
F2	FOD
F3	LPRB_EN and TERM
F4	SDA
F5	LPRB1 and WPG
F6	COMM2
G1	VO_REG
G2	ILIM
G3	CM_ILIM
G4	TS
G5	TMEM
G6	LPRB2 and PD_DET

## 6 Test Procedure

This procedure describes test configuration of the bq51221EVM-520 evaluation board (PWR520-001) for bench evaluation.

### 6.1 Definition

The following naming conventions are used:

**VXXX** : External voltage supply name (VAD, VOUT, VTS)

**LOADW**: External load name (LOADR, LOADI)

**V(TPyy)**: Voltage at internal test point TPyy. For example, V(TP02) means the voltage at TP02.

**V(Jxx)**: Voltage at header Jxx

**V(TP(XXX))**: Voltage at test point XXX. For example, V(ACDET) means the voltage at the test point which is marked as ACDET.

**V(XXX, YYY)**: Voltage across point XXX and YYY.

**I(JXX(YYY))**: Current going out from the YYY terminal of header XX.

**Jxx(BBB)**: Terminal or pin BBB of header xx.

**JPx ON** : Internal jumper Jxx terminals are shorted.

**JPx OFF**: Internal jumper Jxx terminals are open.

**JPx (-YY-) ON**: Internal jumper Jxx adjacent terminals marked as YY are shorted.

Assembly drawings have location for jumpers, test points, and individual components.

### 6.2 Recommended Test Equipment

The following equipment is needed to complete this test procedure:

#### Power Supplies

Power Supply #1 (PS #1) capable of supplying 19 V at 1 A is required power plug to supply the PMA transmitter (An adapter usually included on the PMA TX module).

#### Loads

A resistive load or electronic load that can be set to 5  $\Omega$ /1000 mA, 10  $\Omega$ /500 mA, and 5 k $\Omega$ /1 mA power rating should be 5 W.

#### Meters

Two DC voltmeters and two DC ammeters are required.

#### Oscilloscopes

Not required.

#### bqTesla Transmitter and PMA Transmitter

- The transmitter HPA689 or equivalent will be used to test WPC mode
- PMA to test PMA mode (Duracell Powermat for 2 Devices “PMA compatible”—M2PB1)
- For proper operation, 22-AWG wire is recommended

### 6.3 Equipment Setup

#### 6.3.1 Test Set Up

- The final assembly will be tested using a bqTesla transmitter (HPA689). Input voltage to the transmitter is set to 19 VDC  $\pm$ 200 mV with current limit of 1.0 A.
- Connect power supply to J1 and J2 of transmitter, HPA689
- Set power supply to OFF
- Place Unit Under Test (UUT) on transmitter coil



- UUT will be placed in the center of HPA689 TX coil. Other bqTesla transmitter base units are also acceptable for this test (Just make sure to apply the right input voltage).
- A PMA (Duracell Powermat TX) transmitter is needed to test the PMA compliance

### 6.3.2 Load

- The load is connected between J3-OUT and J4-GND of the UUT
- A DC ammeter is connected between UUT and Load
- Set the load for 5  $\Omega$ /1000 mA

### 6.3.3 Jumper Settings

JP1 → ILIM and FIX are shorted  
JP2 → CM\_ILIM and high are shorted

### 6.3.4 Voltage and Current Meters

Connect ammeter to measure 19-V input current to transmitter. Connect voltmeter to monitor input voltage at J1 and J2 of TX unit. On UUT a voltmeter is used to measure output voltage at J3 with ground at J4. Connect ammeter to measure load current.

### 6.3.5 RFOD : R6 Set Up

Connect an ohmmeter between TP5 (FOD) and J4 (GND). Adjust R6 to 480 ohm reading on the ohmmeter.

## 6.4 Procedure

### 6.4.1 Turn ON Operation and Operation at 1000-mA Load

- Turn ON Transmitter power supply (19 V)
- Transmitter—Verify LED D2 is “ON”
- UUT—Adjust load current to 1000 mA  $\pm$ 50 mA
- Put the receiver EVM on the Transmitter coil and align them correctly
- After 5 seconds verify that:
  - Transmitter—Status LED D5 should be green flashing ~ 1 sec
  - You should hear a beep from the transmitter
  - Transmitter—LED D2 still ON
  - Receiver—LED D1 is ON
- UUT—Verify that Vout is 4.9 V to 5.1 V ( Between J3 and J4)
- UUT—Verify that rectified voltage should be 5 V to 5.4 V (between TP3 and GND) (note: a modulation signal is present on this voltage every 250 ms and may cause fluctuation in the reading use lower value or base line)

### 6.4.2 Efficiency Test (1000-mA Load)

- Verify that input current to TX is less than 500 mA with input voltage at 19 VDC
- Turn OFF Transmitter Power Supply (19 V)

### 6.4.3 Turn ON Operation and Operation at 500-mA Load

- Turn ON Transmitter power supply (19 V)
- Transmitter—Verify LED D2 is “ON”
- UUT—Adjust load current to 500 mA  $\pm$ 50 mA
- Put the receiver EVM on the Transmitter coil and align them correctly

- After 5 seconds verify that:
- Transmitter—Status LED D5 should be green flashing ~ 1 sec
- You should hear a beep from the transmitter
- Transmitter—LED D2 still ON
- Receiver—LED D1 is ON
- UUT—Verify that Vout is 4.9 V to 5.2 V ( Between J3 or TP7 and J4)
- UUT—Verify that rectified voltage should be 5 V to 5.4 V (between TP3 and GND) (Note: a modulation signal is present on this voltage every 250 ms and may cause fluctuation in the reading use lower value or base line)

#### 6.4.4 Efficiency Test (500-mA Load)

- Verify that input current to TX is less than 260 mA with input voltage at 19 VDC
- Turn OFF Transmitter Power Supply (19 V)

#### 6.4.5 Operation (1-mA Load)

- Turn ON Transmitter power supply (19 V)
- Transmitter—Verify LED D2 is “ON”
- UUT—Adjust load current to 1 mA  $\pm$ 200  $\mu$ A
- Put the receiver EVM on the Transmitter coil and align them correctly
- After 5 seconds verify that:
- Transmitter—Status LED D5 should be green flashing ~ 1 sec.
- You should hear a beep from the transmitter
- Transmitter—LED D2 still ON
- Receiver—LED D1 is ON
- UUT—Verify that Vout is 4.9 V to 5.2 V ( Between J3 and J4)
- UUT—Verify that rectified voltage should be 6.6 V to 8.6 V (between TP3 and GND) (Note: a modulation signal is present on this voltage every 250 ms and may cause fluctuation in the reading use lower value or base line)

#### 6.4.6 Efficiency Test (1-mA Load)

- Verify that input current to TX is less than 80 mA with input voltage at 19 VDC
- Turn OFF Transmitter Power Supply (19 V)

#### 6.4.7 PMA Test (1000-mA Load)

- Turn ON PMA Transmitter power supply(18 V) or by using the adapter that comes with the PMA transmitter
- Put the receiver EVM on the Transmitter coil and align them correctly
- After 5 seconds verify that:
  1. You should hear a beep from the transmitter
  2. Receiver—LED D3 is ON
- UUT—Adjust load current to 1000 mA  $\pm$ 50 mA
- UUT—Verify that Vout is 4.9 V to 5.2 V ( Between J3 and J4)
- UUT—Verify that rectified voltage should be 5 V to 5.4 V (between TP3 and GND) (Note: a modulation signal is present on this voltage every 250 ms and may cause fluctuation in the reading use lower value or base line)

### 6.4.8 Adapter Test (500-mA Load)

- Connect 5-V  $\pm 200$  mV adapter on J1 on the PWR520-001 Receiver
- Adjust load current to 500 mA  $\pm 50$  mA (J3 “OUT” and J4 “GND”)
- Verify that:
  1. UUT—LED D3 is ON
  2. UUT—Vout is 5.0 V to 6 V (J3)
  3. Transmitter—Status LED D5 is off

## 7 Test Results

### 7.1 Steady State Operation with bq2425x Charger

With the power supply off, connect supply to the PMA transmitter.

- Set up the test bench as described in [Section 6](#)
- Power PMA TX with 18 V or with the PMA power adapter
- Connect the output of RX to a battery charger (bq24250EVM-150) to charge a battery
- Set the VBAT to 3.8 V
- Set the charger current to  $\sim 1.2$  A
- Set input current limit from the charger to 1 A
- Monitor the IOOUT and VOUT from the RX after putting the receiver EVM on the transmitter coil and align them correctly
- [Figure 2](#) shows the VOUT and IOOUT from the RX as the battery charges

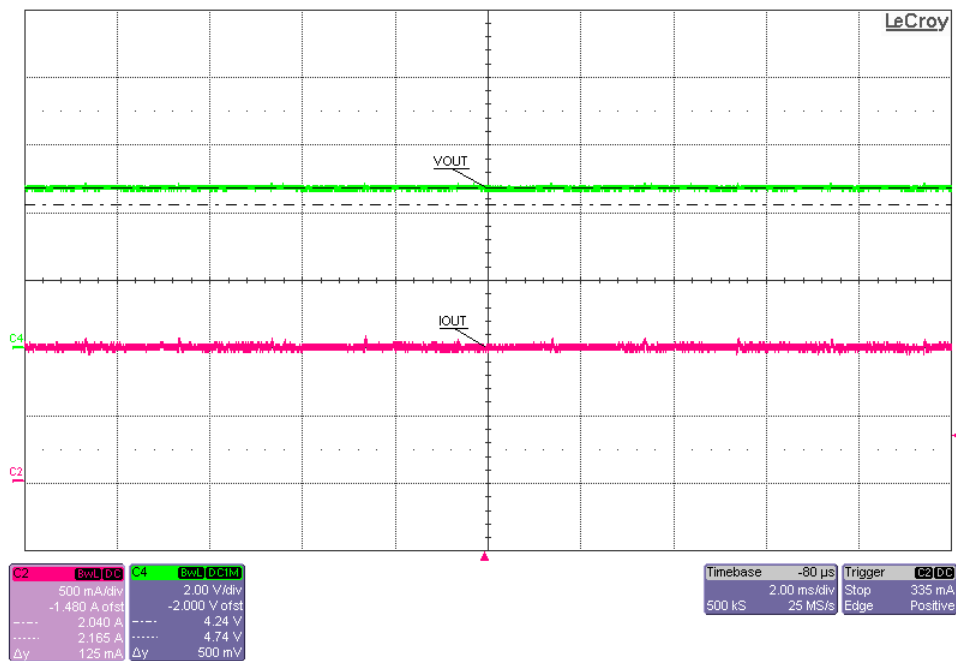

**Figure 2. bq51221 in Steady State Operation with bq24250EVM**

## 7.2 Load Step

The procedure for load step in PMA mode is as follows:

- Set up the test bench as described in [Section 6](#)
- Power PMA TX with 18 V or with the PMA power adapter
- Connect the output of RX to a battery charger (bq24250EVM-150) to charge a battery
- Set the VIN\_DPM of the charger to 4.6 V
- Set a battery voltage to full charge state and connect system load to system output of the charger. Then, put the receiver EVM on the transmitter coil and align them correctly.
- Provide a load step from no-load (high impedance) to 1000-mA on the system load
- Monitor on side RX: load current, rectifier voltage, and output voltage as shown in [Figure 3](#)

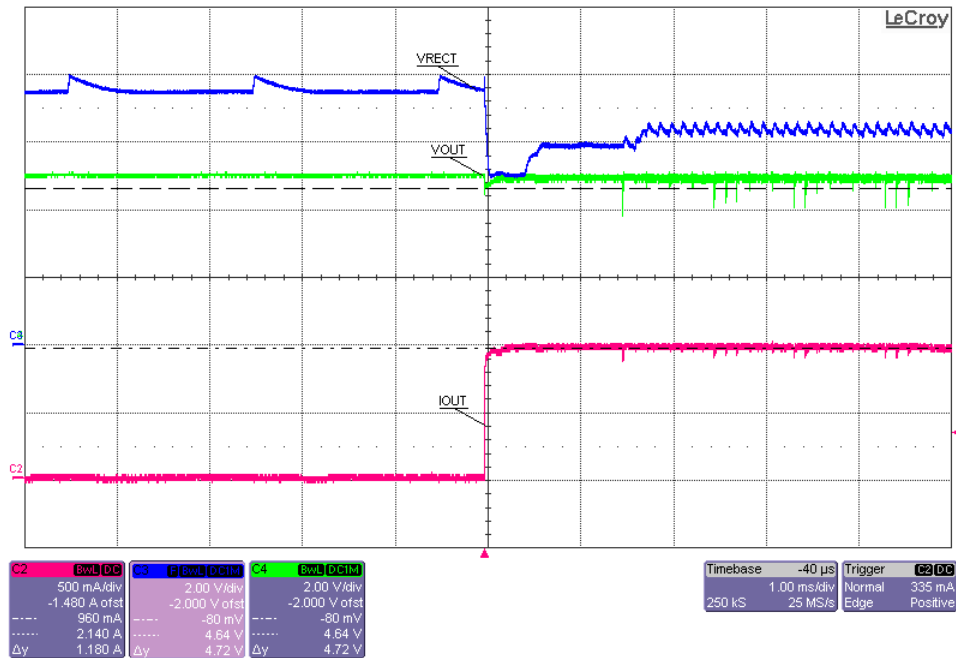
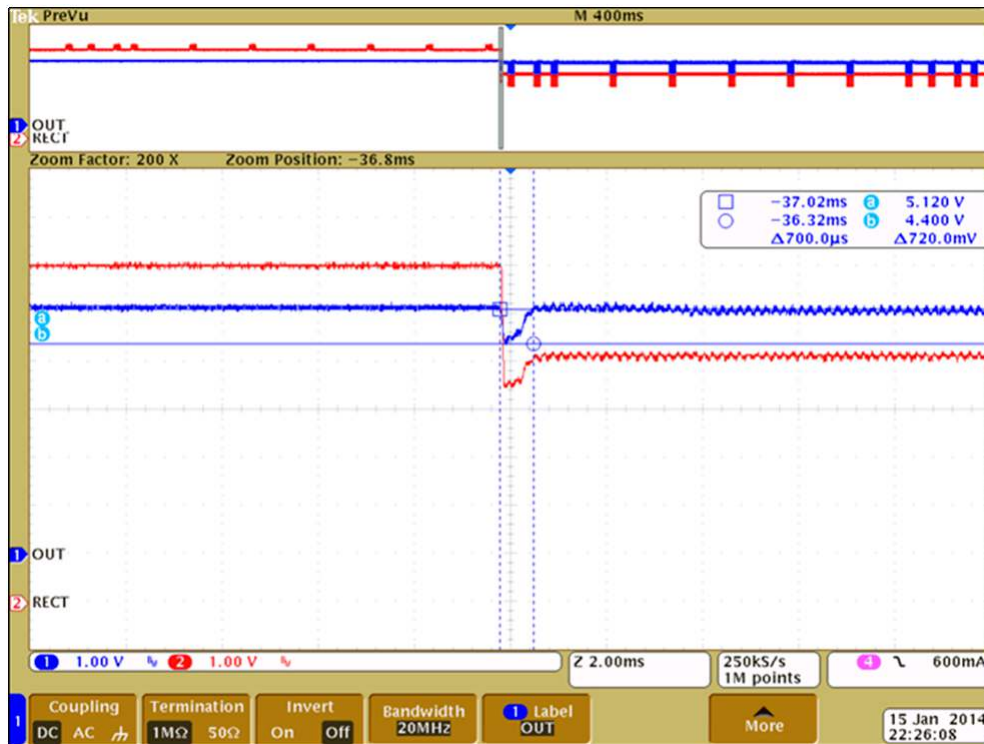

Figure 3. Load Step (PMA) with VIN\_DPM

The procedure for load step in WPC mode is as follows:

- Set up the test bench as described in [Section 6](#) for a WPC transmitter
- Power WPC TX with 19 V. Then put the receiver EVM on the transmitter coil and align them correctly.
- Provide a load step from no-load (high impedance) 1000 mA (if using current source load)
- Monitor on side RX: Rectifier voltage, and output voltage as shown in [Figure 4](#)



0 to 1000 mA Step

Figure 4. Load Step (WPC)

### 7.3 TS Control Function

The procedure for temperature sensing (TS) control functions when the TS pin is held high:

- Set up the test bench as described in [Section 6](#)
- Power the PMA TX. Then put the receiver EVM on the transmitter coil and align them correctly.
- Drive the TS pin high (2 V) using external power supply
- Monitor the TS pin, PMA signal (If a test fixture is used—to see End of Charge),  $\overline{WPG}$ , and output voltage as shown in [Figure 5](#)

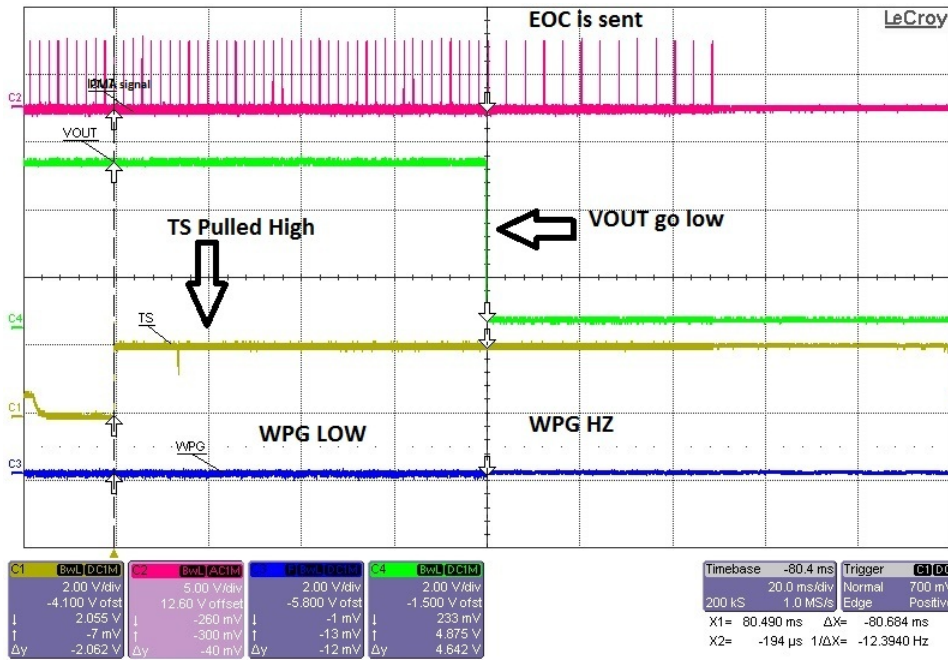

Figure 5. TS Control Function

### 7.4 Efficiency Data

The plot shown in Figure 6 illustrates the system (DC-DC) efficiency of the bq51221EVM-520 under different transmitters.

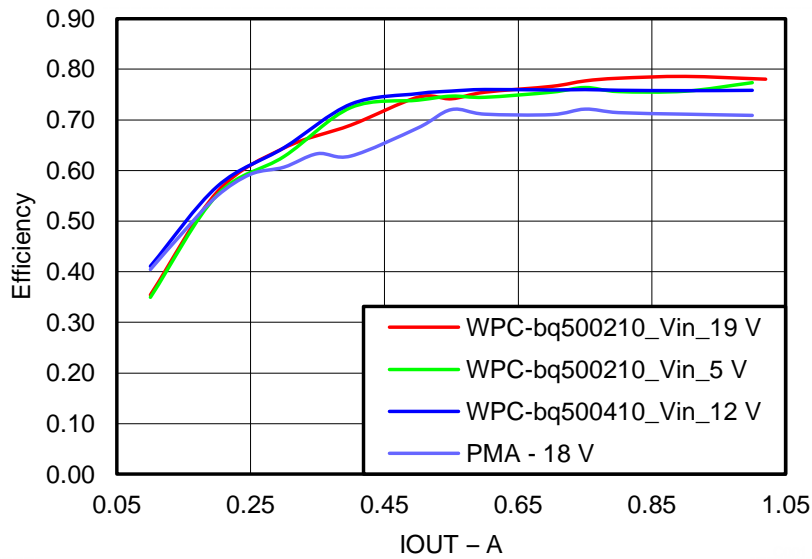

Figure 6. System Efficiency versus Output Current

### 7.5 AD Insertion and Removal

The plot shown in Figure 7 illustrates the behavior of the bq51221 when the AD is inserted while the EVM is on the transmitter pad. There is a 36-ms off time during the transition between wireless power and wired power modes.

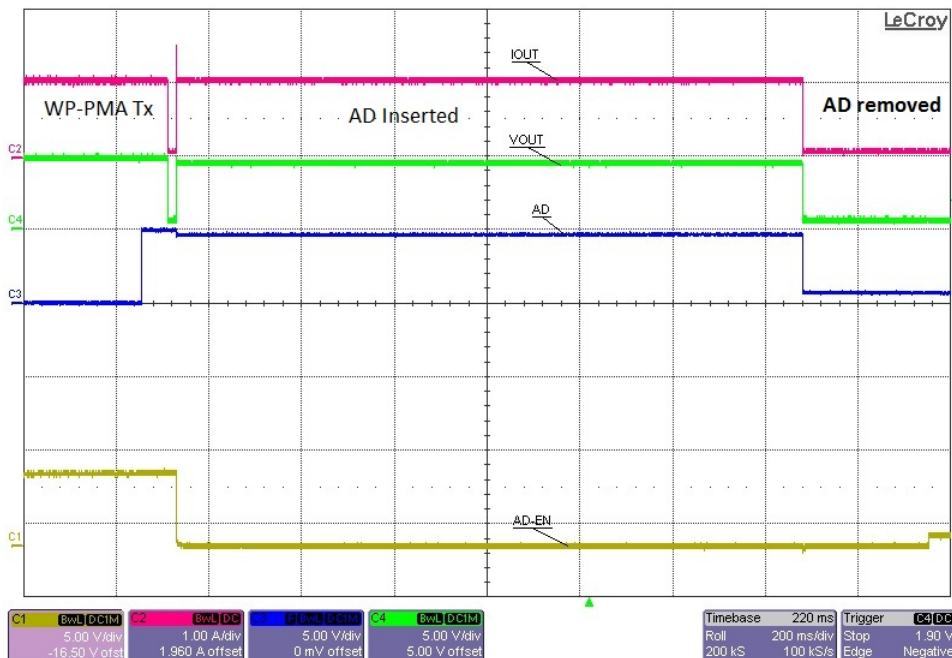

Figure 7. AD Insertion and Removal



## 7.6 Thermal Performance

This section shows a thermal image of the bq51221EVM-520 in both WPC and PMA. A 1-A load is used and output voltage is set to 5 V. There is no air flow and the ambient temperature is 25°C. The peak temperature of the IC (39°C in WPC and 37°C in PMA) is well below the maximum recommended operating condition listed in the data sheet.

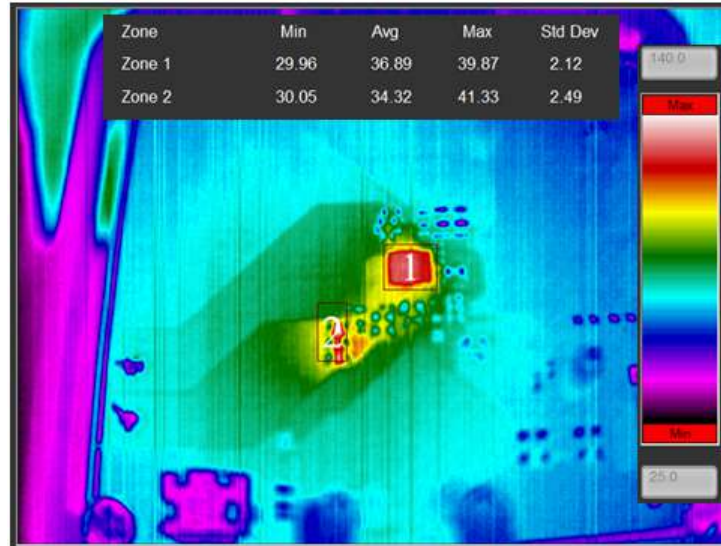

Figure 8. Thermal Image in WPC Transmitter (1000-mA Load)

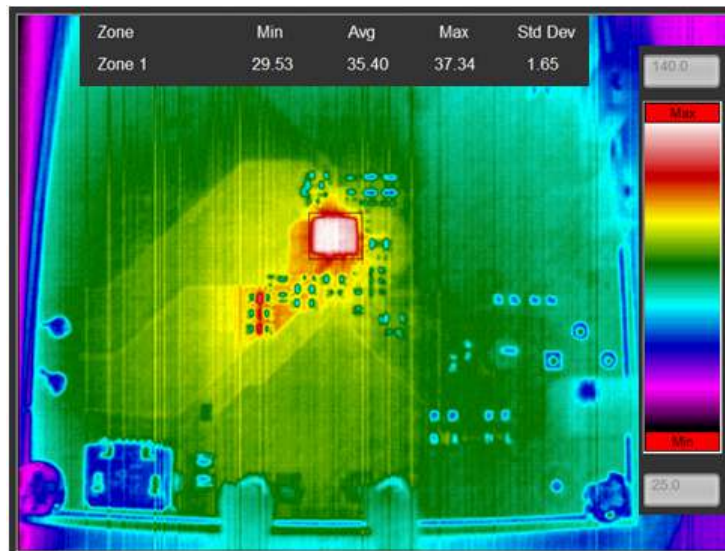

Figure 9. Thermal Image in PMA Transmitter (1000-mA Load)



## 8 Dual Mode Coil Design Consideration

### 8.1 Shielding

Implementation of a shielding mechanism is recommended as part of receiver device. Shielding provides protection from possible bi-directional interference between wireless charging system and consumer electronic device. The interference causes may include coupling interference causing development of heat due to eddy currents, impact on wireless charging data transfer, and so forth. It is recommended to apply the shield on all the magnetically active area (between the secondary coil and the electronic device).

### 8.2 Receiver Detection: Attraction and Alignment

When a PMA Transmitter is in standby phase and a receiver is placed on the charging surface, the transmitter detects the presence of the receiver by using either passive method with a “Hall Effect Sensor” or by active method with digital pinging.

In the passive method, the transmitter uses a Hall Effect Sensor to detect the presence of a receiver coil. It measures the voltage difference between no coil on TX and a full aligned coil on TX. If the difference in the hall sensor measurements between the two cases is above 200 mV, the power transfer phase will start as required by PMA. In the active method, it uses a digital pinging method instead. This detection method uses a periodic short pulse or short burst of pulses applied to the primary coil. By measuring the resultant interference on the primary coil, the presence of a receiver can be detected.

For both methods, a PMA-compliant receiver coil design shall include materials that can trigger the Hall Effect Sensor and create enough interference on the digital pinging on the PMA transmitters. The implementation is vendor specific and may rely on the magnetic material used for alignment aid, the shielding, or any other material designers select.

The alignment aid ferrite should have no more than 2 mm distance from charged device outer surface. The recommended shielding ferrite placed on the receiver antenna and the alignment aid fit into the hole at the center of the shielding ferrite as indicated in [Figure 10](#).

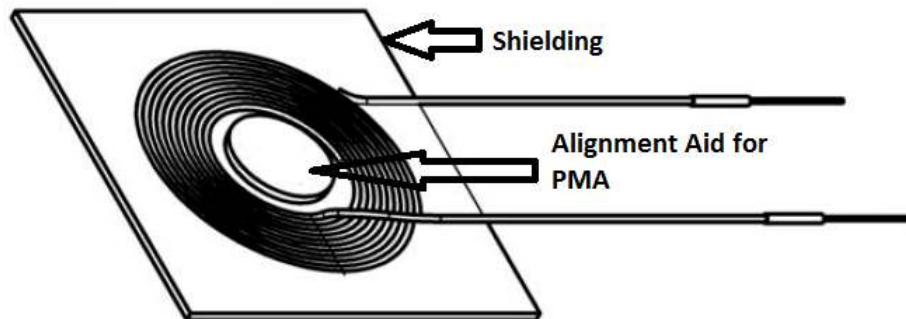

Figure 10. Dual Mode Coil Example

### 8.3 Inductor Value

A PMA-compliant receiver operating frequency is between 232 kHz and 278 kHz. For best efficient PMA only systems, the recommended coil self-inductance is around 4- $\mu$ H range and coil self-resistance is around 300 m $\Omega$ . The operating frequency for PMA is higher than WPC. Thus, for dual mode solution the inductance has to be increased to meet WPC requirements. For dual mode applications, a recommended coil self-inductance is about 7.5  $\mu$ H and coil self-resistance is around 300 m $\Omega$ .

In this EVM, the 760308102210 coil from Wurth electronics is used as an example for dual mode solution. Other coils also can be used such as KNCWZ08C409 from Panasonic and ASC-353583M08-S0 V1.0 from Amotech. The resonant capacitors are not required for PMA mode only. To support WPC and PMA, tuning resonant caps according to WPC requirement and with the final configuration of the board is a must. Note that the coil inductance and the required shielding may vary from application to application depending on the final configuration of the board.

## 9 Layout and Bill of Materials

### 9.1 bq5122x Traces

The bq5122x device pins traces can be classified as follows:

- **Signal/Sensing Traces**

TS/CTRL, SDA, SCL, LPRB2/PD\_DET, LPRB1/WPG, COMM, CHG, ILIM, AD, AD\_EN, FOD, TMEM, CM\_ILIM, VO\_REG, VIREG, LPRB\_EN/TERM.

Make sure these trace are not being interfered by the noisy traces.

- **Noisy Traces**

AC1, AC2, BOOT, COMM

Make sure to isolated these traces from other traces, you can use ground plan.

- **Power Traces**

AC1, AC2, OUT, CLAMP, PGND

Make sure to use the right width for the right current rating.

### 9.2 Layout Guidelines

- The traces from the input connector to the inputs of the bq5122x IC pin should be as wide as possible to minimize the impedance in the lines. Otherwise, a voltage drop and thermal issue will be caused.
- Keep the trace resistance as low as possible on AC1, AC2, and OUT.
- Use the appropriate current rating traces (width) on the AC, OUT, CLAMP and GND.
- The PCB should have a ground plane (return) connected directly to the return of all components through vias (At least two vias per capacitor for power-stage capacitors, one via per capacitor for small-signal components).
- The dissipation of heat path is important. Adding internal layers increases the thermal performance. Multiple vias in the PGND pulls of the IC is recommended to decrease the thermal resistance in the board and allow much easier thermal dissipation through inner layer and power ground layers.
- The via interconnect is important and must be optimized near the power pad of the IC and the GND.
- 2-oz copper or greater is recommended
- For high-current applications, the balls for the power paths should be connected to as much copper in the board as possible. This allows better thermal performance because the board conducts heat away from the IC.
- It is always a good practice to place high frequency bypass capacitors next to RECT and OUT.

### 9.3 Printed-Circuit Board Layout Example

The primary concerns when doing a layout for a custom receiver PCB are as follows:

- AC1 and AC2, GND return trace resistance
- OUT trace resistance
- GND connection
- Copper weight  $\geq 2$  oz

For a 1-A fast charge current application, the current rating for each net is as follows:

- AC1 = AC2 = 1.2 A
- BOOT1 = BOOT2 = 1 A
- RECT = 10 mA
- OUT = 1 A
- COMM1 = COMM2 = 300 mA
- CLAMP1 = CLAMP2 = 500 mA
- ILIM = 10 mA

- $AD = \overline{AD\_EN} = TS\_CTRL = SCL = SDA = TERM = FOD = 1\text{ mA}$
- $CHG = 10\text{ mA}$

It is also recommended to have the following capacitance on RECT and OUT:

- $RECT \geq 10\ \mu\text{F}$
- $OUT \geq 1\ \mu\text{F}$

It is always good practice to place high frequency bypass capacitors next to RECT and OUT of  $0.1\ \mu\text{F}$ . Figure 11 illustrates an example of a WCSP layout.

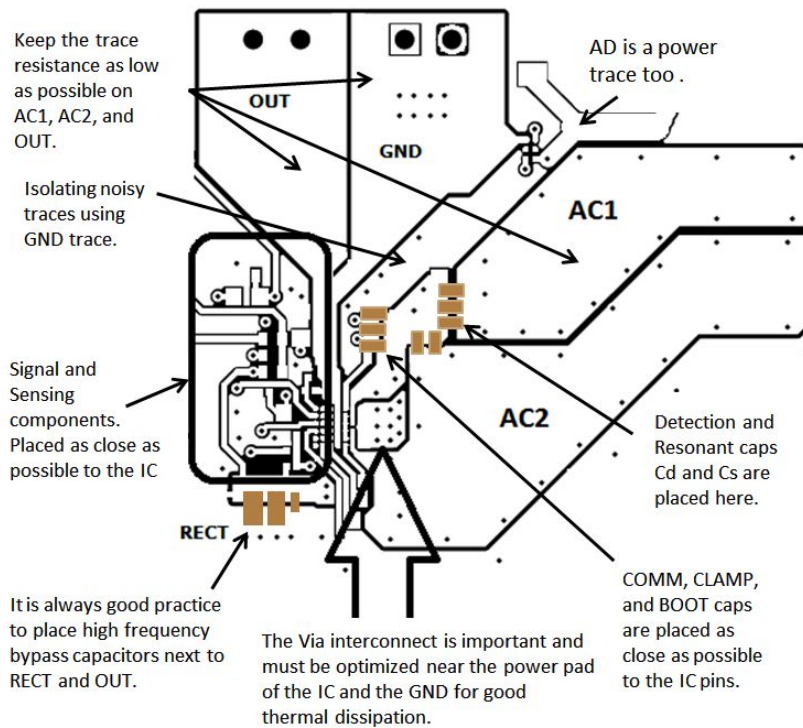

**Figure 11. bq51221EVM-520 Layout Example**

### 9.4 bq51221EVM-520 Layout

Figure 12 through Figure 16 illustrate the bq51221EVM-520 layout views.

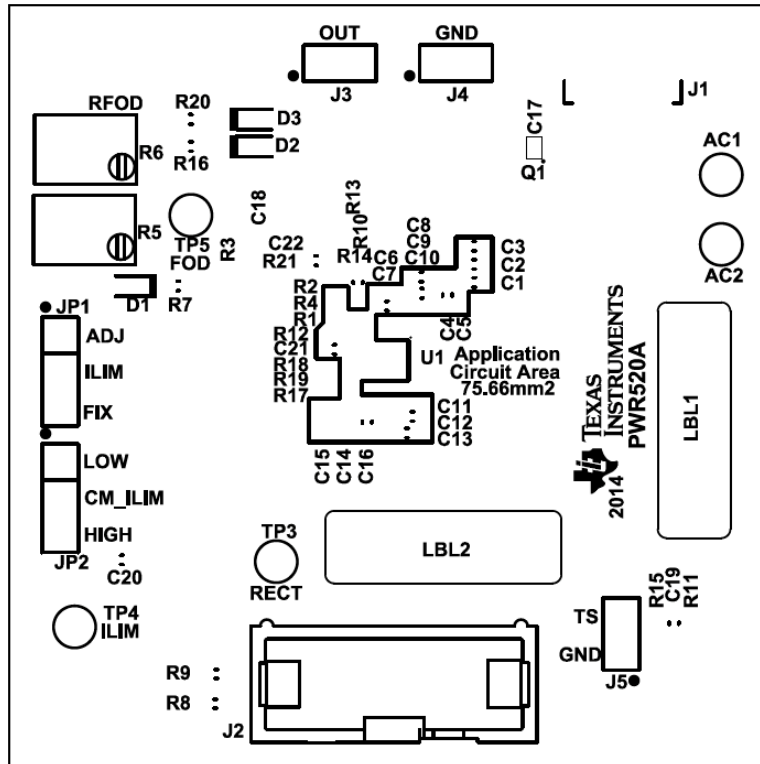

Figure 12. bq51221EVM-520 Top Assembly

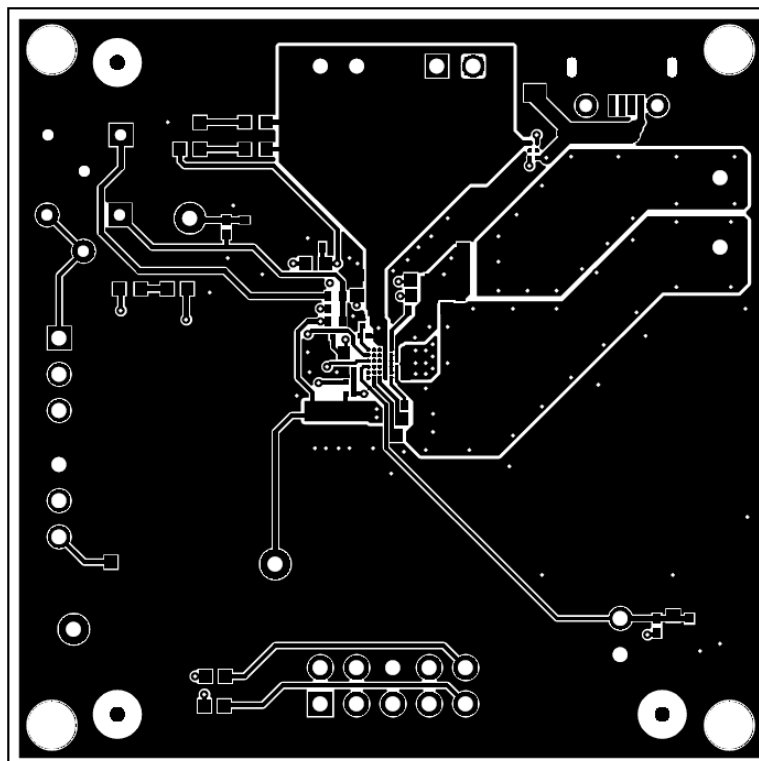

Figure 13. bq51221EVM-520 Layer 1

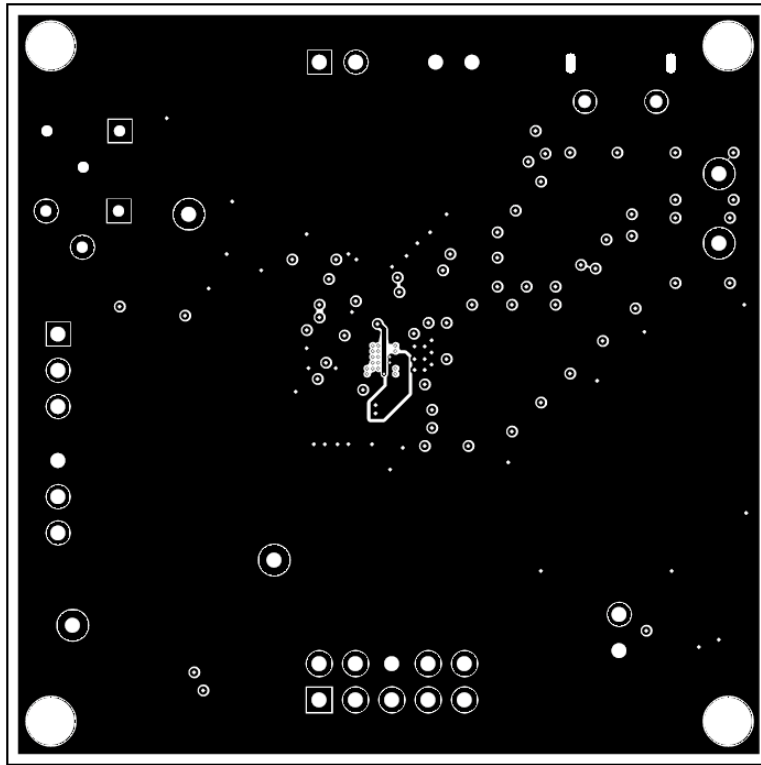

Figure 14. bq51221EVM-520 Layer 2

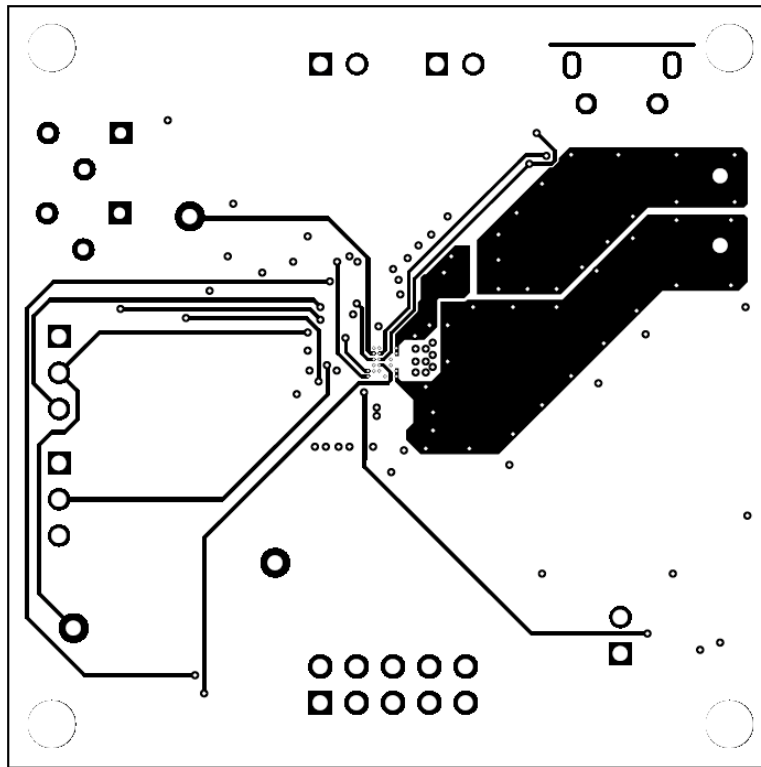

Figure 15. bq51221EVM-520 Layer 3

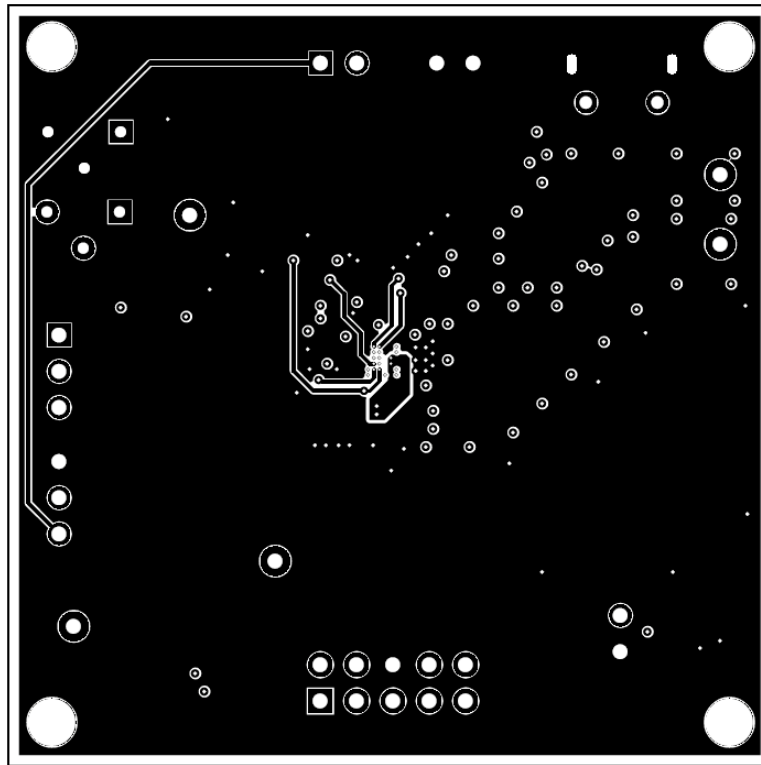

Figure 16. bq51221EVM-520 Layer 4

### 9.5 Bill of Materials

Table 3 lists the BOM for the bq51221EVM-520.

**Table 3. bq51221EVM-520 Rev. B Bill of Materials**

RefDes	Qty	Value	Description	Package Reference	Part No.	Manufacturer
C1	1	0.1uF	CAP, CERM, 0.1uF, 50V, ±10%, X7R, 0603	603	C0603C104K5RACTU	Kemet
C2	1	0.056uF	CAP, CERM, 0.056uF, 50V, ±10%, X7R, 0603	603	GRM188R71H563KA93D	Murata
C3	1	0.082uF	CAP, CERM, 0.082uF, 50V, ±10%, X7R, 0603	603	GRM188R71H823KA93D	Murata
C4	1	2700pF	CAP, CERM, 2700pF, 50V, ±10%, X7R, 0603	603	GRM188R71H272KA01D	Murata
C5	1	100pF	CAP, CERM, 100pF, 50V, ±10%, X7R, 0402	402	CC0402KRX7R9BB101	Yageo America
C6	1	0.1uF	CAP, CERM, 0.1uF, 50V, ±10%, X7R, 0402	402	C1005X7R1H104K050BB	TDK
C7	1	3.3uF	CAP, CERM, 3.3uF, 25V, ±10%, X5R, 0603	603	C1608X5R1E335K080AC	TDK
C8, C13	2	0.082uF	CAP, CERM, 0.082uF, 25V, ±10%, X7R, 0603	603	GRM188R71E823KA01D	Murata
C9, C12	2	0.47uF	CAP, CERM, 0.47uF, 25V, ±10%, X5R, 0603	603	GRM188R61E474KA12D	Murata
C10, C11	2	0.015uF	CAP, CERM, 0.015uF, 50V, ±10%, X7R, 0402	402	GRM155R71H153KA12D	Murata
C14, C15	2	10uF	CAP, CERM, 10uF, 25V, ±10%, X5R, 0805	805	C2012X5R1E106K125AB	TDK
C16, C19	2	0.1uF	CAP, CERM, 0.1uF, 50V, ±10%, X7R, 0603	603	GCM188R71H104KA57B	Murata
C17	1	1uF	CAP, CERM, 1uF, 50V, ±10%, X7R, 0805	805	GRM21BR71H105KA12L	Murata
C18	1	0.1uF	CAP, CERM, 0.1uF, 16V, ±10%, X7R, 0402	402	GRM155R71C104KA88D	Murata
C20	1	1uF	CAP, CERM, 1uF, 25V, ±10%, X7R, 0603	603	GRM188R71E105KA12D	Murata
C21	1	2.2uF	CAP, CERM, 2.2uF, 16V, ±10%, X5R, 0603	603	GRM188R61C225KE15D	Murata
C22	0	100pF	CAP, CERM, 100pF, 50V, ±10%, X7R, 0402	402	CC0402KRX7R9BB101	Yageo America
D3	1	Green	LED, Green, SMD	1.6x0.8x0.8mm	LTST-C190GKT	Lite-On
H1	1		Tape segment, Low Static Polyimide Film. Cut tape section from 36 yard roll	1.5" x 2.3"	5419-1 1/2"	3M
H2	1		Case Modified Polycase LP-11B with 4 screws		J-6838A	Polycase
H3	1		Coil, RX with Attractor—See Coil Design section		760308102210	Würth
H4–H7	4		#4 x 3/8" pan head phillips screw	#4 x 3/8"	PSMS 004 0038 PH	B&F Fastener
H8–H11	4		Spacer, 0.100" Thk x 0.25" OD x 0.147" ID	0.1" THK	905-100	Bivar
J1	1		Receptacle, Micro-USB-B, Right Angle, SMD	Micro USB receptacle	105017-0001	Molex
J2	1		Connector, 100mil Shrouded, High-Temperature, Gold, TH	5x2 Shrouded header	N2510-6002-RB	3M
J3, J4	2		Header, 100mil, 2x1, Tin plated, TH	Header, 2 PIN, 100mil, Tin	PEC02SAAN	Sullins Connector Solutions
JP1, JP2	2		Header, 100mil, 3x1, Tin plated, TH	Header, 3 PIN, 100mil, Tin	PEC03SAAN	Sullins Connector Solutions
LBL1, LBL2	2		Thermal Transfer Printable Labels, 0.650" W x 0.200" H - 10,000 per roll	PCB Label 0.650"H x 0.200"W	THT-14-423-10	Brady
Q1	1	-20V	MOSFET, P-CH, -20V, -1.2A, 2x3 DSBGA	2x3 DSBGA	CSD75301W1015	Texas Instruments
R1	1	56.2k	RES, 56.2k ohm, 1%, 0.063W, 0402	402	CRCW040256K2FKED	Vishay-Dale
R2	1	150	RES, 150 ohm, 5%, 0.063W, 0402	402	CRCW0402150RJNED	Vishay-Dale

**Table 3. bq51221EVM-520 Rev. B Bill of Materials (continued)**

RefDes	Qty	Value	Description	Package Reference	Part No.	Manufacturer
R3	1	0	RES, 0 ohm, 1%, 0.063W, 0402	402	CRCW04020000Z0ED	Vishay-Dale
R4	1	110	RES, 110 ohm, 1%, 0.063W, 0402	402	CRCW0402110RFKED	Vishay-Dale
R6	1	500	Trimmer, 500 ohm, 0.25W, TH	4.5x8x6.7mm	3266W-501LF	Bourns
R8, R9	2	200	RES, 200 ohm, 1%, 0.1W, 0603	603	RT0603BRD07200RL	Yageo America
R10, R18	2	11.3k	RES, 11.3k ohm, 1%, 0.05W, 0201	201	ERJ-1GEF1132C	Panasonic
R11	1	10.0k	RES, 10.0k ohm, 1%, 0.063W, 0402	402	CRCW040210K0FKED	Vishay-Dale
R12	1	5.6Meg	RES, 5.6Meg ohm, 5%, 0.05W, 0201	201	MCR006YRTJ565	Rohm
R13	1	2.00k	RES, 2.00k ohm, 1%, 0.1W, 0603	603	RC0603FR-072KL	Yageo America
R14, R17, R19	3	102k	RES, 102k ohm, 1%, 0.05W, 0201	201	ERJ-1GEF1023C	Panasonic
R20	1	1.50k	RES, 1.50k ohm, 1%, 0.1W, 0603	603	CRCW06031K50FKEA	Vishay-Dale
R21	0	27k	RES, 27k ohm, 5%, 0.1W, 0603	603	CRCW060327K0JNEA	Vishay-Dale
SH-JP1, SH-JP2	2	1x2	Shunt, 100mil, Gold plated, Black	Shunt	969102-0000-DA	3M
TP-TP5	3	White	Test Point, TH, Miniature, White	Keystone5002	5002	Keystone
U1	1		DUAL MODE (Qi and PMA) INTEGRATED WIRELESS RECEIVER POWER SUPPLY, YFP0042AWCG	YFP0042AWCG	bq51221YFP	Texas Instruments
D1	0	Green	LED, Green, SMD	1.6x0.8x0.8mm	LTST-C190GKT	Lite-On
D2	0	Orange	LED, Orange, SMD	1.6x0.8x0.8mm	LTST-C190KFKT	Lite-On
FID1-FID3	0		Fiducial mark. There is nothing to buy or mount.	Fiducial	N/A	N/A
J5	0		Header, 100mil, 2x1, Tin plated, TH	Header, 2 PIN, 100mil, Tin	PEC02SAAN	Sullins Connector Solutions
R5	0	5K	Trimmer, 5k ohm, 0.25W, TH	4.5x8x6.7mm	3266W-502LF	Bourns
R7, R16	0	1.50k	RES, 1.50k ohm, 1%, 0.1W, 0603	603	CRCW06031K50FKEA	Vishay-Dale
R15	0	20k	RES, 20k ohm, 5%, 0.063W, 0402	402	CRCW040220K0JNED	Vishay-Dale
TP1, TP2	0	Black	Test Point, Miniature, Black, TH	Black Miniature Testpoint	5001	Keystone



## Revision History

**Changes from A Revision (March 2014) to B Revision****Page**

- 
- Added information in the abstract including the bq51021 IC as a device that can be evaluated with this EVM..... 1
-

## ADDITIONAL TERMS AND CONDITIONS, WARNINGS, RESTRICTIONS, AND DISCLAIMERS FOR EVALUATION MODULES

Texas Instruments Incorporated (TI) markets, sells, and loans all evaluation boards, kits, and/or modules (EVMs) pursuant to, and user expressly acknowledges, represents, and agrees, and takes sole responsibility and risk with respect to, the following:

1. User agrees and acknowledges that EVMs are intended to be handled and used for feasibility evaluation only in laboratory and/or development environments. Notwithstanding the foregoing, in certain instances, TI makes certain EVMs available to users that do not handle and use EVMs solely for feasibility evaluation only in laboratory and/or development environments, but may use EVMs in a hobbyist environment. All EVMs made available to hobbyist users are FCC certified, as applicable. Hobbyist users acknowledge, agree, and shall comply with all applicable terms, conditions, warnings, and restrictions in this document and are subject to the disclaimer and indemnity provisions included in this document.
2. Unless otherwise indicated, EVMs are not finished products and not intended for consumer use. EVMs are intended solely for use by technically qualified electronics experts who are familiar with the dangers and application risks associated with handling electrical mechanical components, systems, and subsystems.
3. User agrees that EVMs shall not be used as, or incorporated into, all or any part of a finished product.
4. User agrees and acknowledges that certain EVMs may not be designed or manufactured by TI.
5. User must read the user's guide and all other documentation accompanying EVMs, including without limitation any warning or restriction notices, prior to handling and/or using EVMs. Such notices contain important safety information related to, for example, temperatures and voltages. For additional information on TI's environmental and/or safety programs, please visit [www.ti.com/esh](http://www.ti.com/esh) or contact TI.
6. User assumes all responsibility, obligation, and any corresponding liability for proper and safe handling and use of EVMs.
7. Should any EVM not meet the specifications indicated in the user's guide or other documentation accompanying such EVM, the EVM may be returned to TI within 30 days from the date of delivery for a full refund. THE FOREGOING LIMITED WARRANTY IS THE EXCLUSIVE WARRANTY MADE BY TI TO USER AND IS IN LIEU OF ALL OTHER WARRANTIES, EXPRESSED, IMPLIED, OR STATUTORY, INCLUDING ANY WARRANTY OF MERCHANTABILITY OR FITNESS FOR ANY PARTICULAR PURPOSE. TI SHALL NOT BE LIABLE TO USER FOR ANY INDIRECT, SPECIAL, INCIDENTAL, OR CONSEQUENTIAL DAMAGES RELATED TO THE HANDLING OR USE OF ANY EVM.
8. No license is granted under any patent right or other intellectual property right of TI covering or relating to any machine, process, or combination in which EVMs might be or are used. TI currently deals with a variety of customers, and therefore TI's arrangement with the user is not exclusive. TI assumes no liability for applications assistance, customer product design, software performance, or infringement of patents or services with respect to the handling or use of EVMs.
9. User assumes sole responsibility to determine whether EVMs may be subject to any applicable federal, state, or local laws and regulatory requirements (including but not limited to U.S. Food and Drug Administration regulations, if applicable) related to its handling and use of EVMs and, if applicable, compliance in all respects with such laws and regulations.
10. User has sole responsibility to ensure the safety of any activities to be conducted by it and its employees, affiliates, contractors or designees, with respect to handling and using EVMs. Further, user is responsible to ensure that any interfaces (electronic and/or mechanical) between EVMs and any human body are designed with suitable isolation and means to safely limit accessible leakage currents to minimize the risk of electrical shock hazard.
11. User shall employ reasonable safeguards to ensure that user's use of EVMs will not result in any property damage, injury or death, even if EVMs should fail to perform as described or expected.
12. User shall be solely responsible for proper disposal and recycling of EVMs consistent with all applicable federal, state, and local requirements.

**Certain Instructions.** User shall operate EVMs within TI's recommended specifications and environmental considerations per the user's guide, accompanying documentation, and any other applicable requirements. Exceeding the specified ratings (including but not limited to input and output voltage, current, power, and environmental ranges) for EVMs may cause property damage, personal injury or death. If there are questions concerning these ratings, user should contact a TI field representative prior to connecting interface electronics including input power and intended loads. Any loads applied outside of the specified output range may result in unintended and/or inaccurate operation and/or possible permanent damage to the EVM and/or interface electronics. Please consult the applicable EVM user's guide prior to connecting any load to the EVM output. If there is uncertainty as to the load specification, please contact a TI field representative. During normal operation, some circuit components may have case temperatures greater than 60°C as long as the input and output are maintained at a normal ambient operating temperature. These components include but are not limited to linear regulators, switching transistors, pass transistors, and current sense resistors which can be identified using EVMs' schematics located in the applicable EVM user's guide. When placing measurement probes near EVMs during normal operation, please be aware that EVMs may become very warm. As with all electronic evaluation tools, only qualified personnel knowledgeable in electronic measurement and diagnostics normally found in development environments should use EVMs.

**Agreement to Defend, Indemnify and Hold Harmless.** User agrees to defend, indemnify, and hold TI, its directors, officers, employees, agents, representatives, affiliates, licensors and their representatives harmless from and against any and all claims, damages, losses, expenses, costs and liabilities (collectively, "Claims") arising out of, or in connection with, any handling and/or use of EVMs. User's indemnity shall apply whether Claims arise under law of tort or contract or any other legal theory, and even if EVMs fail to perform as described or expected.

**Safety-Critical or Life-Critical Applications.** If user intends to use EVMs in evaluations of safety critical applications (such as life support), and a failure of a TI product considered for purchase by user for use in user's product would reasonably be expected to cause severe personal injury or death such as devices which are classified as FDA Class III or similar classification, then user must specifically notify TI of such intent and enter into a separate Assurance and Indemnity Agreement.

## **RADIO FREQUENCY REGULATORY COMPLIANCE INFORMATION FOR EVALUATION MODULES**

Texas Instruments Incorporated (TI) evaluation boards, kits, and/or modules (EVMs) and/or accompanying hardware that is marketed, sold, or loaned to users may or may not be subject to radio frequency regulations in specific countries.

### **General Statement for EVMs Not Including a Radio**

For EVMs not including a radio and not subject to the U.S. Federal Communications Commission (FCC) or Industry Canada (IC) regulations, TI intends EVMs to be used only for engineering development, demonstration, or evaluation purposes. EVMs are not finished products typically fit for general consumer use. EVMs may nonetheless generate, use, or radiate radio frequency energy, but have not been tested for compliance with the limits of computing devices pursuant to part 15 of FCC or the ICES-003 rules. Operation of such EVMs may cause interference with radio communications, in which case the user at his own expense will be required to take whatever measures may be required to correct this interference.

### **General Statement for EVMs including a radio**

*User Power/Frequency Use Obligations:* For EVMs including a radio, the radio included in such EVMs is intended for development and/or professional use only in legally allocated frequency and power limits. Any use of radio frequencies and/or power availability in such EVMs and their development application(s) must comply with local laws governing radio spectrum allocation and power limits for such EVMs. It is the user's sole responsibility to only operate this radio in legally acceptable frequency space and within legally mandated power limitations. Any exceptions to this are strictly prohibited and unauthorized by TI unless user has obtained appropriate experimental and/or development licenses from local regulatory authorities, which is the sole responsibility of the user, including its acceptable authorization.

### **U.S. Federal Communications Commission Compliance**

#### **For EVMs Annotated as FCC – FEDERAL COMMUNICATIONS COMMISSION Part 15 Compliant**

##### **Caution**

This device complies with part 15 of the FCC Rules. Operation is subject to the following two conditions: (1) This device may not cause harmful interference, and (2) this device must accept any interference received, including interference that may cause undesired operation. Changes or modifications could void the user's authority to operate the equipment.

##### **FCC Interference Statement for Class A EVM devices**

This equipment has been tested and found to comply with the limits for a Class A digital device, pursuant to part 15 of the FCC Rules. These limits are designed to provide reasonable protection against harmful interference when the equipment is operated in a commercial environment. This equipment generates, uses, and can radiate radio frequency energy and, if not installed and used in accordance with the instruction manual, may cause harmful interference to radio communications. Operation of this equipment in a residential area is likely to cause harmful interference in which case the user will be required to correct the interference at its own expense.

##### **FCC Interference Statement for Class B EVM devices**

This equipment has been tested and found to comply with the limits for a Class B digital device, pursuant to part 15 of the FCC Rules. These limits are designed to provide reasonable protection against harmful interference in a residential installation. This equipment generates, uses and can radiate radio frequency energy and, if not installed and used in accordance with the instructions, may cause harmful interference to radio communications. However, there is no guarantee that interference will not occur in a particular installation. If this equipment does cause harmful interference to radio or television reception, which can be determined by turning the equipment off and on, the user is encouraged to try to correct the interference by one or more of the following measures:

- Reorient or relocate the receiving antenna.
- Increase the separation between the equipment and receiver.
- Connect the equipment into an outlet on a circuit different from that to which the receiver is connected.
- Consult the dealer or an experienced radio/TV technician for help.

##### **Industry Canada Compliance (English)**

#### **For EVMs Annotated as IC – INDUSTRY CANADA Compliant:**

This Class A or B digital apparatus complies with Canadian ICES-003.

Changes or modifications not expressly approved by the party responsible for compliance could void the user's authority to operate the equipment.

##### **Concerning EVMs Including Radio Transmitters**

This device complies with Industry Canada licence-exempt RSS standard(s). Operation is subject to the following two conditions: (1) this device may not cause interference, and (2) this device must accept any interference, including interference that may cause undesired operation of the device.

##### **Concerning EVMs Including Detachable Antennas**

Under Industry Canada regulations, this radio transmitter may only operate using an antenna of a type and maximum (or lesser) gain approved for the transmitter by Industry Canada. To reduce potential radio interference to other users, the antenna type and its gain should be so chosen that the equivalent isotropically radiated power (e.i.r.p.) is not more than that necessary for successful communication.

This radio transmitter has been approved by Industry Canada to operate with the antenna types listed in the user guide with the maximum permissible gain and required antenna impedance for each antenna type indicated. Antenna types not included in this list, having a gain greater than the maximum gain indicated for that type, are strictly prohibited for use with this device.

## Canada Industry Canada Compliance (French)

Cet appareil numérique de la classe A ou B est conforme à la norme NMB-003 du Canada

Les changements ou les modifications pas expressément approuvés par la partie responsable de la conformité ont pu vider l'autorité de l'utilisateur pour actionner l'équipement.

### Concernant les EVMs avec appareils radio

Le présent appareil est conforme aux CNR d'Industrie Canada applicables aux appareils radio exempts de licence. L'exploitation est autorisée aux deux conditions suivantes : (1) l'appareil ne doit pas produire de brouillage, et (2) l'utilisateur de l'appareil doit accepter tout brouillage radioélectrique subi, même si le brouillage est susceptible d'en compromettre le fonctionnement.

### Concernant les EVMs avec antennes détachables

Conformément à la réglementation d'Industrie Canada, le présent émetteur radio peut fonctionner avec une antenne d'un type et d'un gain maximal (ou inférieur) approuvé pour l'émetteur par Industrie Canada. Dans le but de réduire les risques de brouillage radioélectrique à l'intention des autres utilisateurs, il faut choisir le type d'antenne et son gain de sorte que la puissance isotrope rayonnée équivalente (p.i.r.e.) ne dépasse pas l'intensité nécessaire à l'établissement d'une communication satisfaisante.

Le présent émetteur radio a été approuvé par Industrie Canada pour fonctionner avec les types d'antenne énumérés dans le manuel d'usage et ayant un gain admissible maximal et l'impédance requise pour chaque type d'antenne. Les types d'antenne non inclus dans cette liste, ou dont le gain est supérieur au gain maximal indiqué, sont strictement interdits pour l'exploitation de l'émetteur.

Mailing Address: Texas Instruments, Post Office Box 655303, Dallas, Texas 75265  
Copyright © 2014, Texas Instruments Incorporated

## Important Notice for Users of EVMs Considered “Radio Frequency Products” in Japan

### EVMs entering Japan are NOT certified by TI as conforming to Technical Regulations of Radio Law of Japan.

If user uses EVMs in Japan, user is required by Radio Law of Japan to follow the instructions below with respect to EVMs:

1. Use EVMs in a shielded room or any other test facility as defined in the notification #173 issued by Ministry of Internal Affairs and Communications on March 28, 2006, based on Sub-section 1.1 of Article 6 of the Ministry's Rule for Enforcement of Radio Law of Japan,
2. Use EVMs only after user obtains the license of Test Radio Station as provided in Radio Law of Japan with respect to EVMs, or
3. Use of EVMs only after user obtains the Technical Regulations Conformity Certification as provided in Radio Law of Japan with respect to EVMs. Also, do not transfer EVMs, unless user gives the same notice above to the transferee. Please note that if user does not follow the instructions above, user will be subject to penalties of Radio Law of Japan.

<http://www.tij.co.jp>

【無線電波を送信する製品の開発キットをお使いになる際の注意事項】 本開発キットは技術基準適合証明を受けておりません。本製品のご使用に際しては、電波法遵守のため、以下のいずれかの措置を取っていただく必要がありますのでご注意ください。

1. 電波法施行規則第6条第1項第1号に基づく平成18年3月28日総務省告示第173号で定められた電波暗室等の試験設備でご使用いただく。
2. 実験局の免許を取得後ご使用いただく。
3. 技術基準適合証明を取得後ご使用いただく。。

なお、本製品は、上記の「ご使用にあたっての注意」を譲渡先、移転先に通知しない限り、譲渡、移転できないものとします

上記を遵守頂けない場合は、電波法の罰則が適用される可能性があることをご留意ください。

日本テキサス・インスツルメンツ株式会社

東京都新宿区西新宿6丁目24番1号

西新宿三井ビル

<http://www.tij.co.jp>

Texas Instruments Japan Limited

(address) 24-1, Nishi-Shinjuku 6 chome, Shinjuku-ku, Tokyo, Japan

## IMPORTANT NOTICE

Texas Instruments Incorporated and its subsidiaries (TI) reserve the right to make corrections, enhancements, improvements and other changes to its semiconductor products and services per JESD46, latest issue, and to discontinue any product or service per JESD48, latest issue. Buyers should obtain the latest relevant information before placing orders and should verify that such information is current and complete. All semiconductor products (also referred to herein as "components") are sold subject to TI's terms and conditions of sale supplied at the time of order acknowledgment.

TI warrants performance of its components to the specifications applicable at the time of sale, in accordance with the warranty in TI's terms and conditions of sale of semiconductor products. Testing and other quality control techniques are used to the extent TI deems necessary to support this warranty. Except where mandated by applicable law, testing of all parameters of each component is not necessarily performed.

TI assumes no liability for applications assistance or the design of Buyers' products. Buyers are responsible for their products and applications using TI components. To minimize the risks associated with Buyers' products and applications, Buyers should provide adequate design and operating safeguards.

TI does not warrant or represent that any license, either express or implied, is granted under any patent right, copyright, mask work right, or other intellectual property right relating to any combination, machine, or process in which TI components or services are used. Information published by TI regarding third-party products or services does not constitute a license to use such products or services or a warranty or endorsement thereof. Use of such information may require a license from a third party under the patents or other intellectual property of the third party, or a license from TI under the patents or other intellectual property of TI.

Reproduction of significant portions of TI information in TI data books or data sheets is permissible only if reproduction is without alteration and is accompanied by all associated warranties, conditions, limitations, and notices. TI is not responsible or liable for such altered documentation. Information of third parties may be subject to additional restrictions.

Resale of TI components or services with statements different from or beyond the parameters stated by TI for that component or service voids all express and any implied warranties for the associated TI component or service and is an unfair and deceptive business practice. TI is not responsible or liable for any such statements.

Buyer acknowledges and agrees that it is solely responsible for compliance with all legal, regulatory and safety-related requirements concerning its products, and any use of TI components in its applications, notwithstanding any applications-related information or support that may be provided by TI. Buyer represents and agrees that it has all the necessary expertise to create and implement safeguards which anticipate dangerous consequences of failures, monitor failures and their consequences, lessen the likelihood of failures that might cause harm and take appropriate remedial actions. Buyer will fully indemnify TI and its representatives against any damages arising out of the use of any TI components in safety-critical applications.

In some cases, TI components may be promoted specifically to facilitate safety-related applications. With such components, TI's goal is to help enable customers to design and create their own end-product solutions that meet applicable functional safety standards and requirements. Nonetheless, such components are subject to these terms.

No TI components are authorized for use in FDA Class III (or similar life-critical medical equipment) unless authorized officers of the parties have executed a special agreement specifically governing such use.

Only those TI components which TI has specifically designated as military grade or "enhanced plastic" are designed and intended for use in military/aerospace applications or environments. Buyer acknowledges and agrees that any military or aerospace use of TI components which have **not** been so designated is solely at the Buyer's risk, and that Buyer is solely responsible for compliance with all legal and regulatory requirements in connection with such use.

TI has specifically designated certain components as meeting ISO/TS16949 requirements, mainly for automotive use. In any case of use of non-designated products, TI will not be responsible for any failure to meet ISO/TS16949.

### Products

Audio	<a href="http://www.ti.com/audio">www.ti.com/audio</a>
Amplifiers	<a href="http://amplifier.ti.com">amplifier.ti.com</a>
Data Converters	<a href="http://dataconverter.ti.com">dataconverter.ti.com</a>
DLP® Products	<a href="http://www.dlp.com">www.dlp.com</a>
DSP	<a href="http://dsp.ti.com">dsp.ti.com</a>
Clocks and Timers	<a href="http://www.ti.com/clocks">www.ti.com/clocks</a>
Interface	<a href="http://interface.ti.com">interface.ti.com</a>
Logic	<a href="http://logic.ti.com">logic.ti.com</a>
Power Mgmt	<a href="http://power.ti.com">power.ti.com</a>
Microcontrollers	<a href="http://microcontroller.ti.com">microcontroller.ti.com</a>
RFID	<a href="http://www.ti-rfid.com">www.ti-rfid.com</a>
OMAP Applications Processors	<a href="http://www.ti.com/omap">www.ti.com/omap</a>
Wireless Connectivity	<a href="http://www.ti.com/wirelessconnectivity">www.ti.com/wirelessconnectivity</a>

### Applications

Automotive and Transportation	<a href="http://www.ti.com/automotive">www.ti.com/automotive</a>
Communications and Telecom	<a href="http://www.ti.com/communications">www.ti.com/communications</a>
Computers and Peripherals	<a href="http://www.ti.com/computers">www.ti.com/computers</a>
Consumer Electronics	<a href="http://www.ti.com/consumer-apps">www.ti.com/consumer-apps</a>
Energy and Lighting	<a href="http://www.ti.com/energy">www.ti.com/energy</a>
Industrial	<a href="http://www.ti.com/industrial">www.ti.com/industrial</a>
Medical	<a href="http://www.ti.com/medical">www.ti.com/medical</a>
Security	<a href="http://www.ti.com/security">www.ti.com/security</a>
Space, Avionics and Defense	<a href="http://www.ti.com/space-avionics-defense">www.ti.com/space-avionics-defense</a>
Video and Imaging	<a href="http://www.ti.com/video">www.ti.com/video</a>

### TI E2E Community

[e2e.ti.com](http://e2e.ti.com)