

# IC Sockets XR2

**OMRON's IC Connectors Have Excellent Reliability and Can Tolerate Momentary Interruptions in Power.**

- Round pins and 4-point (4-finger) contact construction with contact entry holes that are large for easy insertion.
- IC lead contacts placed high for solid connections.
- A wide product range: open-frame, closed-frame, single-row, carrier-type DIP terminals, wrap terminals, solder-sleeve terminals, and low-profile DIP terminals.
- Conforms to UL standards (file no. E 103202) and CSA standards (file no. LR 62678).

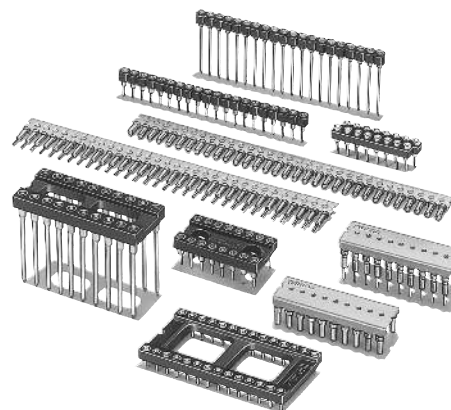

## Construction

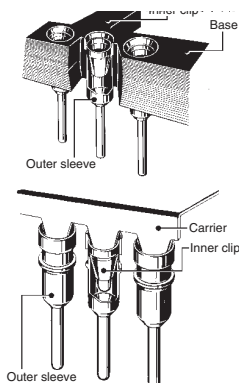

## Contact Dimensions

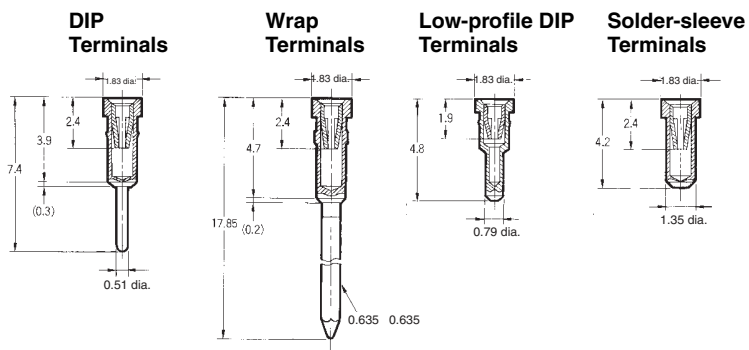

## Ratings and Characteristics

Item	Gold plated	Gold flash plated
Rated current	1 A	
Rated voltage	300 VAC	
Contact resistance	20 mΩ max. (at 20 mV, 100 mA max.)	
Insulation resistance	1,000 MΩ min. (at 500 VDC)	
Dielectric strength	1,000 VAC for 1 min (leakage current: 1 mA max.)	
Contact insertion (See note.)	400 gf (3.92 N) max.	
Contact removal (See note.)	65 gf (0.64 N) min. with gold plating or with solder plating	
Insertion durability	100 times (0.75-μm gold plating), 50 times (0.25-μm gold plating)	20 times
Ambient temperature	Operating: -55 to 125°C (with no icing)	

**Note:** The contact insertion force and contact removal force are for a test gauge, t = 0.432 mm.

## Materials and Finish

Base	Fiber-glass reinforced PBT resin (UL94V-0)/black
Carrier	Aluminum
Inner clip	Beryllium copper/nickel base, gold plated
Outer sleeve	Brass/nickel base, gold flash plating

**Note:** For non-standard plating, contact your OMRON representative.

## Applicable Wrap Post Wire Sizes

AWG30, AWG28, AWG26, AWG24  
(Solid wire: 0.25 to 0.51 mm dia.)

## Wrap Post Length

3 wires

## Applicable IC Lead Dimensions

### DIP, Wrap, and Solder-sleeve Terminals

	Depth × width (mm)	
Flat lead	0.29 ±0.09 × 0.46 ±0.08 (See note.)	
Round lead	0.53 dia. max.	0.41 dia. min.

**Note:** Do not use wire where the diagonal is more than 0.56 mm.

### Low-profile DIP Terminals

	Depth × width (mm)	
Flat lead	0.29 ±0.09 × 0.46 ±0.08 (See note.)	
Round lead	0.50 dia. max.	0.41 dia. min.

**Note:** Do not use wire where the diagonal is more than 0.52 mm.

# XR2A Open-frame Sockets

## ■ Dimensions

XR2A-□□11-N  
 XR2A-2463-N  
 XR2A-2473-N  
 XR2A-□□01-N  
 XR2A-2461-N  
 XR2A-2471-N  
 XR2A-□□21-N  
 XR2A-2467-N  
 XR2A-2477-N  
 (With DIP terminals)

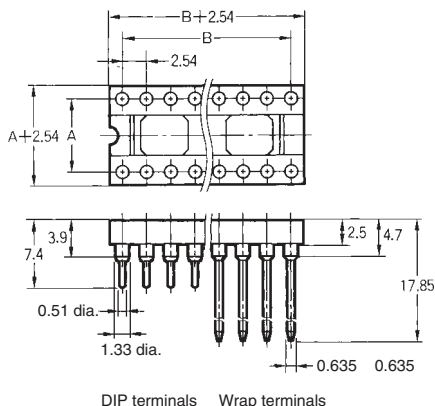
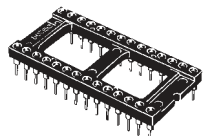

DIP terminals    Wrap terminals

XR2A-□□02  
 (With wrap terminals)

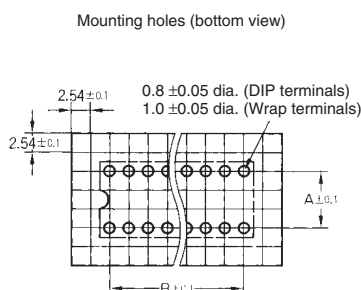
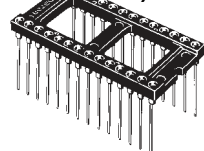

Mounting holes (bottom view)

## Dimensions

No. of contacts	Dimensions (mm)	
	A	B
8	7.62	7.62
14	7.62	15.24
16	7.62	17.78
18	7.62	20.32
20	7.62	22.86
22	10.16	25.40
24 (See note 1.)	15.24	27.94
24 (See note 2.)	10.16	27.94
24 (See note 3.)	7.62	27.94
28	15.24	33.02
32	15.24	38.10
40	15.24	48.26
42	15.24	50.80
48	15.24	58.42
50	22.86	60.96
64	22.86	78.74

- Note:**
1. XR2A-2401-N/XR2A-2402/  
XR2A-2411N/XR2A-2421-N
  2. XR2A-2461-N/XR2A-2463-N/  
XR2A-2467-N
  3. XR2A-2471-N/XR2A-2473-N/  
XR2A-2477-N

## ■ Ordering Information

Appearance		Sockets with DIP terminals			Sockets with wrap terminals
No of contacts	Row pitch (A) (mm)	Sockets with DIP terminals			Sockets with wrap terminals
		With 0.25- $\mu$ m gold plating	With 0.75- $\mu$ m gold plating	With gold flash plating	With 0.75- $\mu$ m gold plating
8	7.62	XR2A-0811-N	XR2A-0801-N	XR2A-0821-N	XR2A-0802
14	7.62	XR2A-1411-N	XR2A-1401-N	XR2A-1421-N	XR2A-1402
16	7.62	XR2A-1611-N	XR2A-1601-N	XR2A-1621-N	XR2A-1602
18	7.62	XR2A-1811-N	XR2A-1801-N	XR2A-1821-N	XR2A-1802
20	7.62	XR2A-2011-N	XR2A-2001-N	XR2A-2021-N	XR2A-2002
22	10.16	XR2A-2211-N	XR2A-2201-N	XR2A-2221-N	XR2A-2202
24	15.24	XR2A-2411-N	XR2A-2401-N	XR2A-2421-N	XR2A-2402
24	10.16	XR2A-2463-N	XR2A-2461-N	XR2A-2467-N	—
24	7.62	XR2A-2473-N	XR2A-2471-N	XR2A-2477-N	XR2A-2472
28	15.24	XR2A-2811-N	XR2A-2801-N	XR2A-2821-N	XR2A-2802
32	15.24	XR2A-3211-N	XR2A-3201-N	XR2A-3221-N	XR2A-3202
40	15.24	XR2A-4011-N	XR2A-4001-N	XR2A-4021-N	XR2A-4002
42	15.24	XR2A-4211-N	XR2A-4201-N	XR2A-4221-N	XR2A-4202
48	15.24	XR2A-4811-N	XR2A-4801-N	—	XR2A-4802
50	22.86	XR2A-5011-N	XR2A-5001-N	—	—
64	22.86	XR2A-6411-N	XR2A-6401-N	—	XR2A-6402

# XR2A Open-frame Sockets (with Low-profile DIP Terminals)

## ■ Dimensions

XR2A-□□15  
 XR2A-2466  
 XR2A-2476  
 XR2A-□□05  
 XR2A-2465  
 XR2A-2475  
 XR2A-□□25  
 XR2A-2468  
 XR2A-2478

(With low-profile DIP terminals)

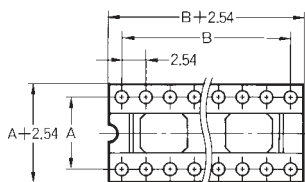
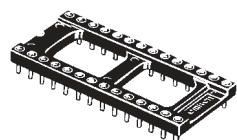

Mounting holes (bottom view)

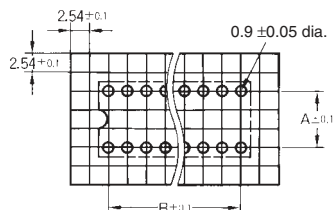

## Dimensions

No. of contacts	Dimensions (mm)	
	A	B
8	7.62	7.62
14	7.62	15.24
16	7.62	17.78
18	7.62	20.32
20	7.62	22.86
22	10.16	25.40
24 (See note 1.)	15.24	27.94
24 (See note 2.)	10.16	27.94
24 (See note 3.)	7.62	27.94
28	15.24	33.02
32	15.24	38.10
40	15.24	48.26
42	15.24	50.80
48	15.24	58.42
64	22.86	78.74

- Note: 1.** XR2A-2415/XR2A-2405/  
XR2A-2425  
**2.** XR2A-2466/XR2A-2465/  
XR2A-2468  
**3.** XR2A-2476/XR2A-2475/  
XR2A-2478

## ■ Ordering Information

Appearance		Sockets with DIP terminals		
No. of contacts	Row pitch (A) (mm)	With 0.25-μm gold plating	With 0.75-μm gold plating	With gold flash plating
8	7.62	XR2A-0815	XR2A-0805	XR2A-0825
14	7.62	XR2A-1415	XR2A-1405	XR2A-1425
16	7.62	XR2A-1615	XR2A-1605	XR2A-1625
18	7.62	XR2A-1815	XR2A-1805	XR2A-1825
20	7.62	XR2A-2015	XR2A-2005	XR2A-2025
22	10.16	XR2A-2215	XR2A-2205	XR2A-2225
24	15.24	XR2A-2415	XR2A-2405	XR2A-2425
24	10.16	XR2A-2466	XR2A-2465	XR2A-2468
24	7.62	XR2A-2476	XR2A-2475	XR2A-2478
28	15.24	XR2A-2815	XR2A-2805	XR2A-2825
32	15.24	XR2A-3215	XR2A-3205	XR2A-3225
40	15.24	XR2A-4015	XR2A-4005	XR2A-4025
42	15.24	XR2A-4215	XR2A-4205	—
48	15.24	XR2A-4815	XR2A-4805	—
64	22.86	XR2A-6415	XR2A-6405	—

# XR2B Closed-frame Sockets

## ■ Dimensions

XR2B-1611-N  
XR2B-1601-N

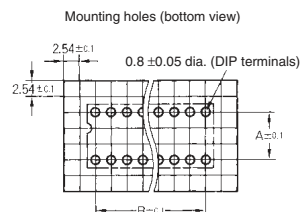
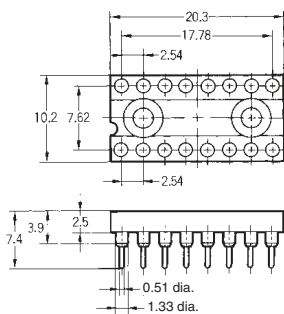
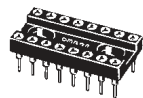

XR2B-□□11-N  
XR2B-□□01-N

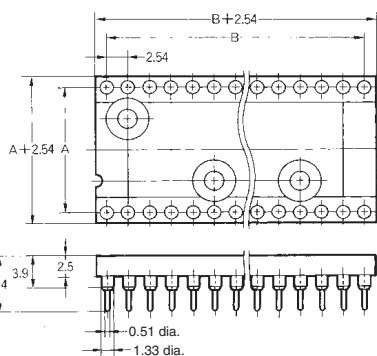
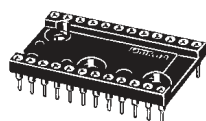

### Dimensions

No. of contacts	Dimensions (mm)	
	A	B
16	7.62	17.78
24	15.24	27.94
28	15.24	33.02
32	15.24	38.10
40	15.24	48.26

## ■ Ordering Information

Appearance		Sockets with DIP terminals	
No. of contacts	Row pitch (A) (mm)	With 0.25- $\mu$ m gold plating	With 0.75- $\mu$ m gold plating
16	7.62	XR2B-1611-N	XR2B-1601-N
24	15.24	XR2B-2411-N	XR2B-2401-N
28	15.24	XR2B-2811-N	XR2B-2801-N
32	15.24	XR2B-3211-N	XR2B-3201-N
40	15.24	XR2B-4011-N	XR2B-4001-N

# XR2T Open-frame Sockets with Seal Tape

- Equipped with seal tape to prevent flux cleaning liquids from entering the Socket.
- The same round-pin, 4-point contact structure as the RX2A is used for the contacts.
- The seal tape is made of transparent polyethylene (adhesive portion) and yellow polypropolyene (non-adhesive portion).

## ■ Dimensions

- XR2T-□□11-N
- XR2T-2463-N
- XR2T-2473-N
- XR2T-□□01-N
- XR2T-2461-N
- XR2T-2471-N
- XR2T-□□21-N
- XR2T-2467-N
- XR2T-2477-N

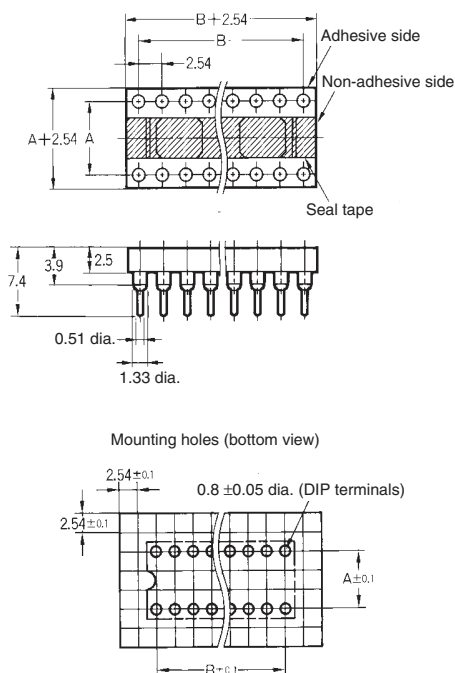
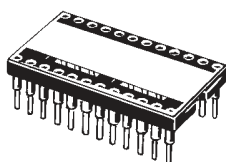

## Dimensions

No. of contacts	Dimensions (mm)	
	A	B
8	7.62	7.62
14	7.62	15.24
16	7.62	17.78
18	7.62	20.32
20	7.62	22.86
22	10.16	25.40
24 (See note 1.)	15.24	27.94
24 (See note 2.)	10.16	27.94
24 (See note 3.)	7.62	27.94
28	15.24	33.02
32	15.24	38.10
40	15.24	48.26
48	15.24	58.42

- Note:**
1. XR2T-2411-N/XR2T-2401-N/  
XR2A-2421-N
  2. XR2T-2463-N/XR2T-2461-N/  
XR2T-2467-N
  3. XR2T-2473-N/XR2T-2471-N/  
XR2T-2477-N

## ■ Ordering Information

Appearance		Sockets with DIP terminals		
No. of contacts	Row pitch (A) (mm)			
		With 0.25- $\mu$ m gold plating	With 0.75- $\mu$ m gold plating	With gold flash plating
8	7.62	XR2T-0811-N	XR2T-0801-N	XR2T-0821-N
14	7.62	XR2T-1411-N	XR2T-1401-N	XR2T-1421-N
16	7.62	XR2T-1611-N	XR2T-1601-N	XR2T-1621-N
18	7.62	XR2T-1811-N	XR2T-1801-N	XR2T-1821-N
20	7.62	XR2T-2011-N	XR2T-2001-N	XR2T-2021-N
22	10.16	XR2T-2211-N	XR2T-2201-N	XR2T-2221-N
24	15.24	XR2T-2411-N	XR2T-2401-N	XR2T-2421-N
24	10.16	XR2T-2463-N	XR2T-2461-N	XR2T-2467-N
24	7.62	XR2T-2473-N	XR2T-2471-N	XR2T-2477-N
28	15.24	XR2T-2811-N	XR2T-2801-N	XR2T-2821-N
32	15.24	XR2T-3211-N	XR2T-3201-N	XR2T-3221-N
40	15.24	XR2T-4011-N	XR2T-4001-N	XR2T-4021-N
48	15.24	XR2T-4811-N	XR2T-4801-N	---

# XR2C Single-row Sockets

## ■ Dimensions

XR2C-□□11-N  
 XR2C-□□01-N  
 XR2C-□□21-N  
 (With DIP terminals)

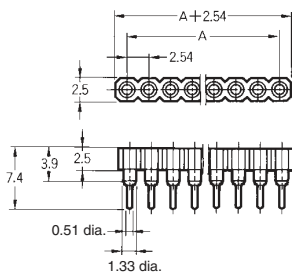
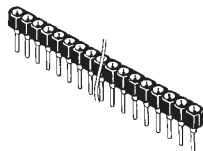

XR2C-□□15  
 XR2C-□□05  
 XR2C-□□25  
 (With low-profile DIP terminals)

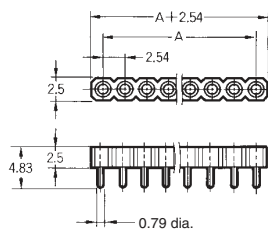
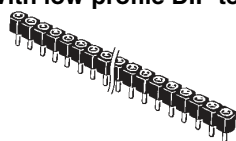

XR2C-□□02  
 (With wrap terminals)

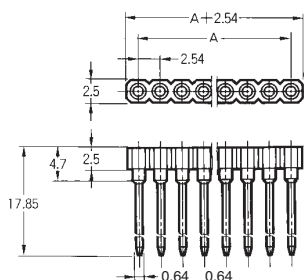

Mounting holes (bottom view)

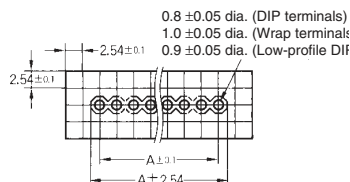

Dimensions

No. of contacts	A (mm)
20	48.26
32	78.74

## ■ Ordering Information

Appearance	No. of contacts	With 0.25- $\mu$ m gold plating	With 0.75- $\mu$ m gold plating	With gold flash plating
Sockets with DIP terminals 	10	XR2C-1011-N	—	—
	16	XR2C-1611-N	—	—
	20	XR2C-2011-N	XR2C-2001-N	XR2C-2021-N
	32	XR2C-3211-N	XR2C-3201-N	XR2C-3221-N
Sockets with low-profile DIP terminals 	20	XR2C-2015	XR2C-2005	XR2C-2025
	32	XR2C-3215	XR2C-3205	XR2C-3225
Sockets with wrap terminals 	20	—	XR2C-2002	—
	32	—	XR2C-3202	—

# XR2D Double-row Carrier Sockets

## ■ Dimensions

XR2D-□□01-N  
(With DIP terminals)

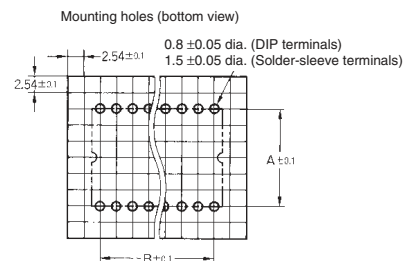
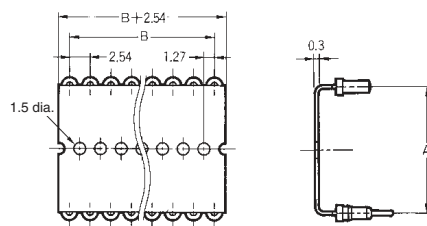
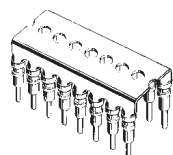

XR2D-□□04  
(With solder-sleeve terminals)

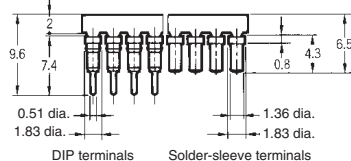
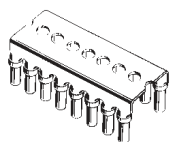

### Dimensions

No. of contacts	Dimensions (mm)	
	A	B
8	7.62	7.62
14	7.62	15.24
16	7.62	17.78
18	7.62	20.32
20	7.62	22.86
24	15.24	27.94
28	15.24	33.02
32	15.24	38.10
40	15.24	48.26

## ■ Ordering Information

Appearance		Sockets with DIP terminals	Sockets with solder-sleeve terminals
No. of contacts	Row pitch (A) (mm)	With 0.75-μm gold plating	With 0.75-μm gold plating
8	7.62	XR2D-0801-N	XR2D-0804
14	7.62	XR2D-1401-N	XR2D-1404
16	7.62	XR2D-1601-N	XR2D-1604
18	7.62	XR2D-1801-N	XR2D-1804
20	7.62	XR2D-2001-N	XR2D-2004
24	15.24	XR2D-2401-N	XR2D-2404
28	15.24	XR2D-2801-N	XR2D-2804
32	15.24	XR2D-3201-N	XR2D-3204
40	15.24	XR2D-4001-N	XR2D-4004

# XR2E Single-row Carrier Sockets

## ■ Dimensions

**XR2E-3201-N**  
(With DIP terminals)

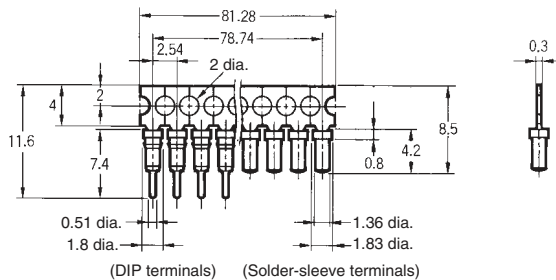
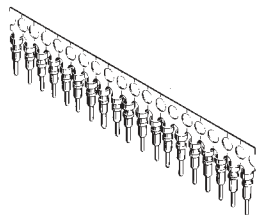

**XR2E-3204**  
(With solder-sleeve terminals)

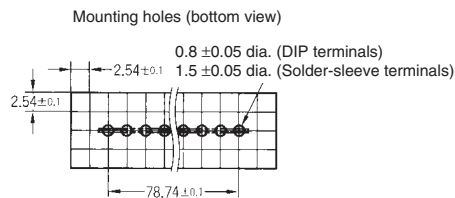
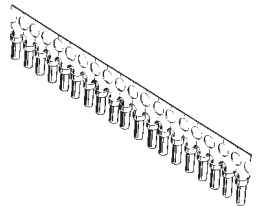

## ■ Ordering Information

Appearance	Sockets with DIP Terminals	Sockets with Solder-sleeve Terminals
No. of contacts	With 0.75- $\mu$ m gold plating	With 0.75- $\mu$ m gold plating
32	XR2E-3201-N	XR2E-3204



# XR2H ZIP (Zigzag) Sockets

## ■ Dimensions

XR2H-□□11-N  
(With DIP terminals)

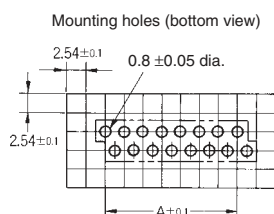
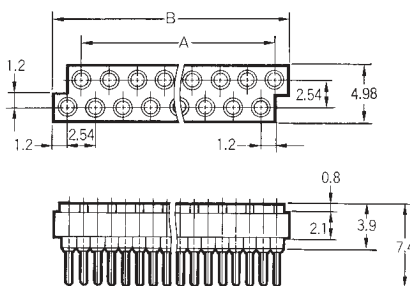
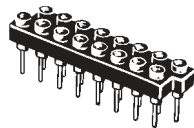

### Dimensions

No. of contacts	Dimensions (mm)	
	A	B
16	17.78	21.5
20	22.86	26.5
24	27.94	31.6
28	33.02	36.7

## ■ Ordering Information

Appearance	Sockets with DIP terminals
No. of contacts	With 0.25-μm gold plating
16	XR2H-1611-N
20	XR2H-2011-N
24	XR2H-2411-N
28	XR2H-2811-N

# XR2P Single-row Round Pin Plugs

## Single-row Round Pins for Low-profile Stacking

- Single row with 2.54-mm pitch.
- Low-profile stacking possible in combination with Single-row IC Sockets (XR2C).
- Easily divided into the desired number of contacts.

### ■ Ratings and Characteristics

Rated current	1 A
Rated voltage	300 VAC
Contact resistance (See note.)	20 mΩ max. (at 20 mV, 10 mA max.)
Insulation resistance	1,000 MΩ min. (at 500 VDC)
Dielectric strength	1,000 VAC for 1 min (leakage current: 1 mA max.)
Ambient operating temperature	-55 to 125°C (with no icing at low temperature)

Note: The contact and vibration resistance are the values when the Plug is mated with an XR2C.

### ■ Materials and Finish

Base	Fiber-glass reinforced PBT resin (UL94V-0)/black	
Contacts	Mating end	Brass/nickel base with 0.25-μm gold plating
	Terminal	

### ■ Applicable Sockets

XR2C-□□11-N	IC Sockets (single row)
XR2C-3215	IC Socket (single row, low profile)

### ■ Dimensions

XR2P-□□41  
(With DIP straight terminals)

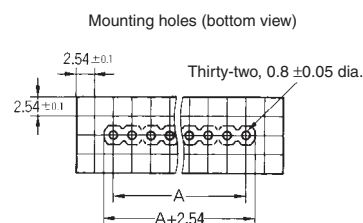
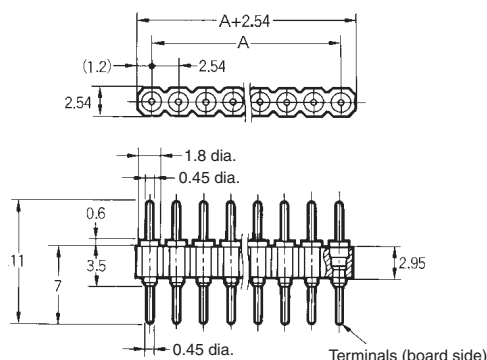
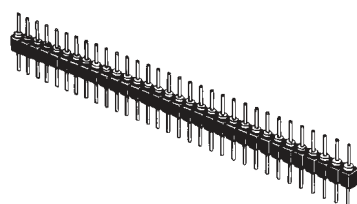

#### Dimensions

No. of contacts	A (mm)
10	22.86
16	38.1
20	48.26
32	78.74

### ■ Ordering Information

No. of contacts	Model
10	XR2P-1041
16	XR2P-1641
20	XR2P-2041
32	XR2P-3241

### ■ Mated Dimensions

XR2P-□□41 with XR2C-□□11-N  
Single-row IC Socket

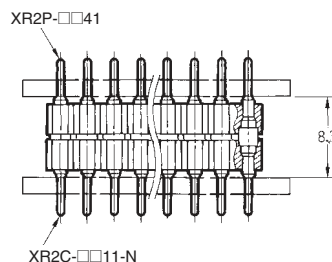

XR2P-3241 with XR2C-3215  
Single-row Low-profile IC Socket

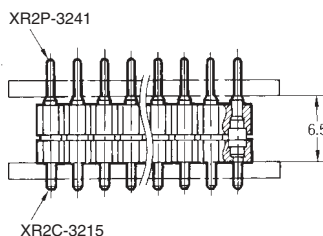

XR2P-3241 with XR2E-3204  
Single-row Carrier Socket with Solder-sleeve Terminals

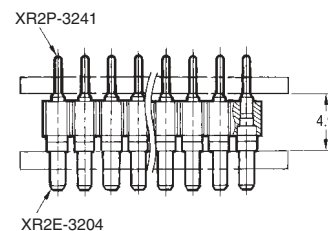

## Tools and Accessories

**XR2Z-11**  
IC Holder (made from PBT)

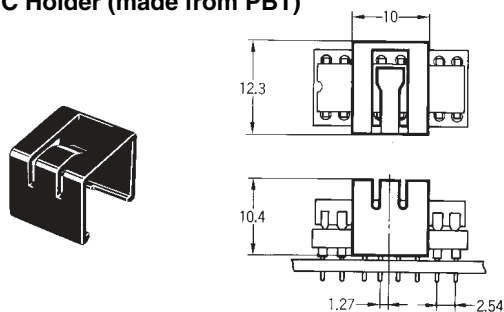

**XR2Z-13**

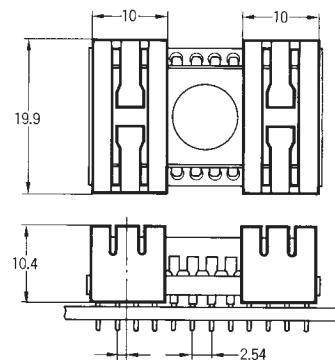
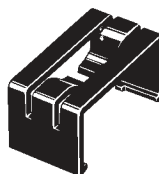

**Note:** Order the following models in multiples of the minimum order.

Model	No. of IC Socket contacts	IC socket width	Order in multiples of
XR2Z-11	14, 16, 18, 20, 24	7.62 mm	100
XR2Z-13	24, 28, 32, 40, 42, 48	15.24 mm	500

**Note:** This Holder protects the IC from falling out due to shock. The IC will not fall out even with a 980 m/s<sup>2</sup> shock. Applicable IC height: 2.7 to 5.6 mm.

**XY2C-0101**  
**XY2C-0103**  
IC Removal Tool

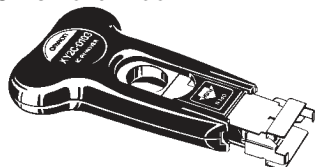

Model	No. of IC Socket contacts	IC socket width
XY2C-0101	14, 16, 18, 20	7.62 mm
XY2C-0103	24, 28, 32, 40	15.24 mm

## Precautions

### Correct Use

#### Soldering

- When soldering, make sure that the outer sleeve of the IC Socket does not stick out of the circuit board through-holes.

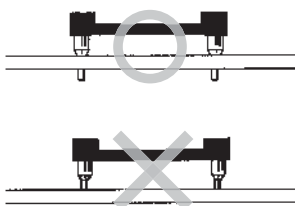

- Make sure that no flux enters the IC Socket from the top.

#### Removing ICs

- Use the XY2C-0101 or XY2C-0103 IC Removal Tool to remove ICs.
- Do not use a screwdriver to remove the IC. It may damage the circuit board.
- Do not use a testing rod or check pin to check contacts or circuits. This may damage the inner clips or plating and may lead to improper contact.
- Four-point contact construction is used for plated products to make them more tolerant of momentary power interruptions. We recommend using gold-plated contacts in areas subject to vibration and shock.

#### Automated Soldering Conditions (Jet Flow)

- Soldering temperature: 250±5°C
- Continuous soldering time: Within 5 s

#### Applicable IC Lead Dimensions

- Use leads that are within the range shown here. For details, refer to the first page of this datasheet. Use an IC with leads longer than 3 mm. If the leads are too long, the IC will not sit flush on the board.
- Use an IC with tapered leads for easy insertion, a minimum amount of bending, and minimum damage to the leads.

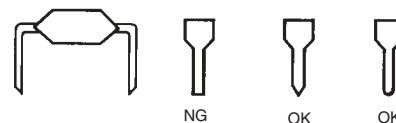

All sales are subject to Omron Electronic Components LLC standard terms and conditions of sale, which can be found at [http://www.components.omron.com/components/web/webfiles.nsf/sales\\_terms.html](http://www.components.omron.com/components/web/webfiles.nsf/sales_terms.html)

**ALL DIMENSIONS SHOWN ARE IN MILLIMETERS.**  
To convert millimeters into inches, multiply by 0.03937. To convert grams into ounces, multiply by 0.03527.

---

**OMRON**<sup>®</sup>  
**OMRON ELECTRONIC  
COMPONENTS LLC**  
55 E. Commerce Drive, Suite B  
Schaumburg, IL 60173  
**847-882-2288**

**OMRON ON-LINE**  
Global - <http://www.omron.com>  
USA - <http://www.components.omron.com>