

NBC-R4AC/20,0-93F/R4AC - Network cable



1199404

<https://www.phoenixcontact.com/us/products/1199404>

Please be informed that the data shown in this PDF document is generated from our online catalog. Please find the complete data in the user documentation. Our general terms of use for downloads are valid.



Network cable, Ethernet CAT5e, 4-position, TPE, Teal, shielded, Plug straight RJ45 / IP20, on Plug straight RJ45 / IP20, cable length: 20 m

Commercial data

Item number	1199404
Packing unit	1 pc
Sales key	AB11
Product key	ABNABA
GTIN	4063151261436
Weight per piece (including packing)	22.22 g
Weight per piece (excluding packing)	22.22 g
Country of origin	US

1199404

<https://www.phoenixcontact.com/us/products/1199404>

Technical data

Product properties

Product type	Data cable preassembled
Sensor type	Ethernet
Number of positions	4
No. of cable outlets	1
Number of slots	1
Shielded	yes
Cable outlet	straight

Interfaces

Signal type/category	Ethernet CAT5e
----------------------	----------------

Electrical properties

Nominal voltage U_N	30 V AC
	57 V DC
Nominal current I_N	1.5 A

Mechanical properties

Mechanical data

Insertion/withdrawal cycles	≥ 750
-----------------------------	------------

Material specifications

Flammability rating according to UL 94	V0
Outer sheath, material	TPE

Connector

Connection 1

Type	Plug straight RJ45 / IP20
Number of positions	4 (8)
Handle color	black
Material	(Contact)
	Gold (Contact surface)
	PVC (Housing)
Insertion/withdrawal cycles	≥ 750
Degree of protection	IP20
Number of positions	4
Insertion/withdrawal cycles	750

Connection 2

Type	Plug straight RJ45 / IP20
Number of positions	4 (8)

NBC-R4AC/20,0-93F/R4AC - Network cable



1199404

<https://www.phoenixcontact.com/us/products/1199404>

Handle color	black
Material	(Contact)
	Gold (Contact surface)
	PVC (Housing)
Insertion/withdrawal cycles	≥ 750
Ambient temperature (operation)	-40 °C ... 85 °C
Number of positions	4
Degree of protection	IP20

Cable/line

Cable length	20 m
--------------	------

Highly flexible Ethernet CAT5e [93F]

Dimensional drawing	
Shielded	yes
UL AWM Style	2463 (80 °C / 600 V)
Cable type	Highly flexible Ethernet CAT5e
Cable type (abbreviation)	93F
Signal type/category	Ethernet CAT5e (TIA 568B)
Cable structure	2x2xAWG24/7, SF/UTP
External cable diameter	6.7 mm ±0.25 mm
Outer sheath, material	TPE
External sheath, color	Teal
Conductor material	Tin-plated Cu litz wires
Conductor structure signal line	7x 0.20 mm (7x32)
AWG signal line	24
Conductor cross section	2x 2x 0.2 mm ²
Material wire insulation	PE
Wire diameter incl. insulation	1.2 mm
Single wire, color	white/orange-orange, white/green-green
Twisted pairs	2 cores to the pair
Overall twist	2 pairs to the core
Shielding	Aluminum-lined polyester foil, tinned copper braided shield
Optical shield covering	75 %
Nominal voltage, cable	600 V
Test voltage, cable	2000 V
Wave impedance	100 Ω ±15 Ω (at 100 MHz)

NBC-R4AC/20,0-93F/R4AC - Network cable



1199404

<https://www.phoenixcontact.com/us/products/1199404>

Cable impedance	100 Ω ±15 Ω (at 1 ... 100 MHz)
Number of bending cycles	1000000
Minimum bending radius, drag chain applications	10 x D
Traversing path	0.23 m
Traversing rate	1.5 m/s
Acceleration	20.5 m/s ²
Number of bending cycles	20000000
Minimum bending radius, drag chain applications	20 X D
Torsion force	360 °/m (1 lb. load)
Torsion cycles	3000000
Torsional frequency	71 (cycles/min)
Ambient temperature (operation)	20 °C
Near end crosstalk attenuation (NEXT)	50 dB (with 100 MHz (IEC 62153-4-9))
Return loss (RL)	20 dB (at 10 MHz (+6LOG))
	26 dB (at 20 MHz)
	26 dB (at 100 MHz (-5LOG))
Flame resistance	VW-1
Other resistance	Resistant to welding splashes Abrasion and oil resistance
	UV resistant CMX outdoor
Ambient temperature (operation)	-40 °C ... 80 °C (Cable, flexible installation)

Environmental and real-life conditions

Ambient conditions

Degree of protection	IP20 (RJ45 connector)
	IP20
Ambient temperature (operation)	-40 °C ... 85 °C (RJ45 connector)

NBC-R4AC/20,0-93F/R4AC - Network cable

1199404

<https://www.phoenixcontact.com/us/products/1199404>

Drawings

Dimensional drawing

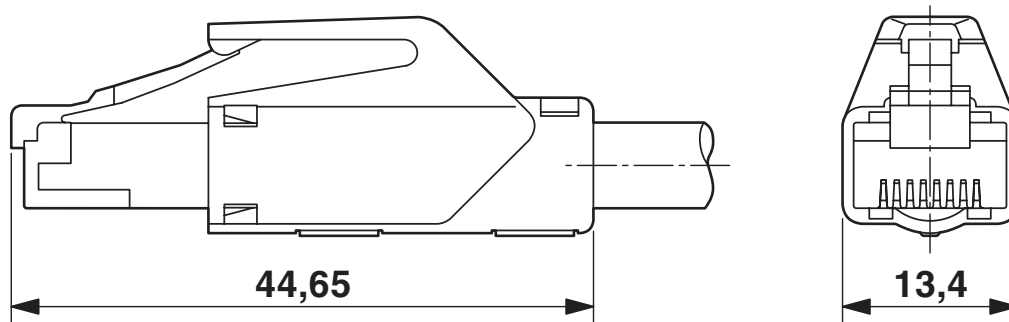

RJ45 connector, IP20

Circuit diagram

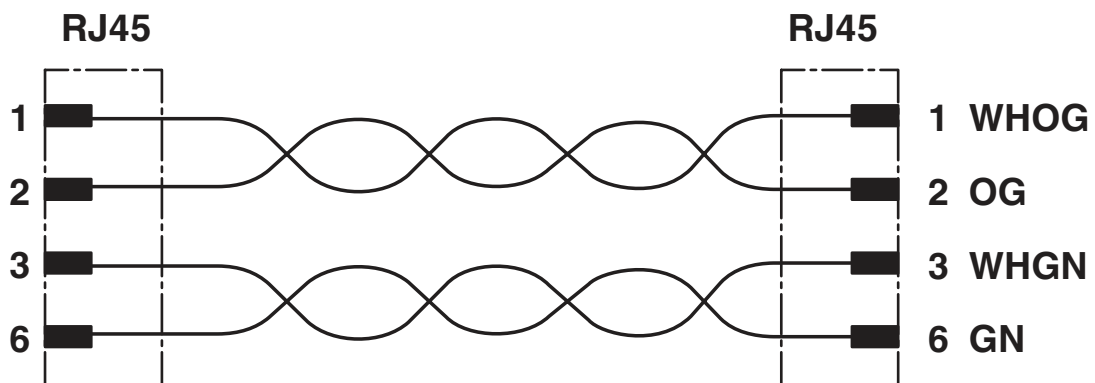

NBC-R4AC/20,0-93F/R4AC - Network cable

1199404

<https://www.phoenixcontact.com/us/products/1199404>



Schematic diagram

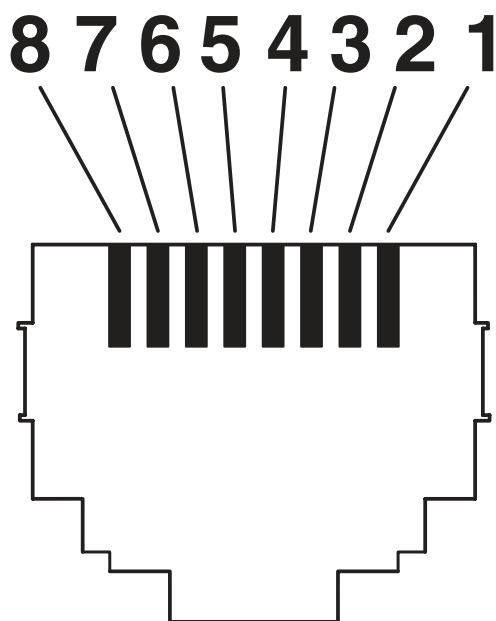

Connector pin assignment plug RJ45

NBC-R4AC/20,0-93F/R4AC - Network cable





1199404

<https://www.phoenixcontact.com/us/products/1199404>

Approvals

To download certificates, visit the product detail page: <https://www.phoenixcontact.com/us/products/1199404>

 UL Listed Approval ID: File E335024				
	Nominal voltage U_N	Nominal current I_N	Cross section AWG	Cross section mm^2
	60 V	0.5 A	-	-

 cUL Listed Approval ID: File E335024				
	Nominal voltage U_N	Nominal current I_N	Cross section AWG	Cross section mm^2
	60 V	0.5 A	-	-

cULus Listed				
---------------------	--	--	--	--

NBC-R4AC/20,0-93F/R4AC - Network cable



1199404

<https://www.phoenixcontact.com/us/products/1199404>

Classifications

ECLASS

ECLASS-11.0	27469090
ECLASS-12.0	27469090
ECLASS-13.0	27469090

ETIM

ETIM 8.0	EC002943
----------	----------

NBC-R4AC/20,0-93F/R4AC - Network cable



1199404

<https://www.phoenixcontact.com/us/products/1199404>

Environmental product compliance

China RoHS	Environmentally friendly use period: unlimited = EFUP-e
	No hazardous substances above threshold values

Phoenix Contact 2023 © - all rights reserved
<https://www.phoenixcontact.com>

Phoenix Contact USA
586 Fulling Mill Road
Middletown, PA 17057, United States
(+717) 944-1300
info@phoenixcon.com