

Slim Amplifier with Plug-in Outputs, Built-in Time Delays

- Universal supply voltage for AC/DC operation
- Plug-in replaceable outputs, relay or solid state
- Light-ON/Dark-ON operation, switch selectable
- Uses E32-series fiber-optic cables - over 150 models available
- Standard 3 A relay output

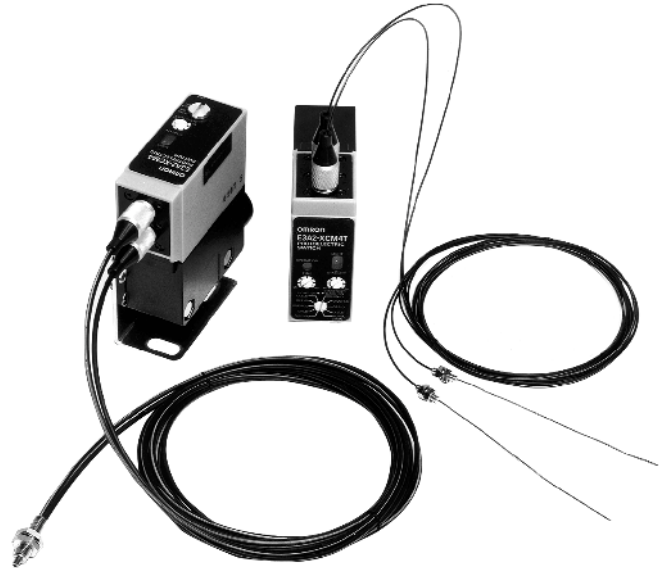

Ordering Information

■ AMPLIFIERS

Part number	E3A2-XCM4	E3A2-XCM4T	E3A2-XCM4D
Built-in timer	Not provided	Provided	
Timer functions	—	ON-delay, OFF-delay, one-shot, or equal ON-delay and OFF-delay (0.1 to 5 seconds)	Independently adjustable ON-delay and OFF-delay (0.1 to 5 seconds)

■ ACCESSORIES (ORDERED SEPARATELY)

Description	Part number	
Solid-state output modules	AC (SCR output module; 200 mA, 250 VAC max. load)	G3K-2R2P-1
	DC NPN-SPDT output module; 200 mA, 30 VDC max. load	G3KD-YR2P-1
	DC PNP-SPDT output module; 30 VDC max. load	G3KD-YR2P-2
Optional mounting chuck for armored fiber-optic cables	E39-FU1-1	

■ REPLACEMENT PARTS

Description	Part number
Relay, output module, SPDT, 3 A at 250 VAC (output supplied with each sensor)	G6C-2117P-DC8
Mounting bracket (supplied with each sensor)	E39-L34
Mounting chuck for standard fiber-optic cables (included with sensor)	E39-FU1

Specifications

Part Number		E3A2-XCM4	E3A2-XCM4T	E3A2-XCM4D
Supply voltage		24 to 240 VAC, 50/60 Hz; 12 to 240 VDC		
Power consumption	Relay output type and DC solid-state output type	1.5 W max.		
	AC solid-state output type	2 VA max.		
Required fiber-optic cables		E32-series fiber-optic cables; armored cables require optional mounting chuck (see Accessories)		
Light source		Pulse modulated red LED		
Operating mode		Light-ON/Dark-ON, switch selectable		
Sensitivity		Adjustable		
Mutual interference protection		Provided		
Control output	Relay	Type	SPDT with G6C-2117P-DC8 output module (standard)	
		Max. load	3 A, 250 VAC (p.f. = 1); 3 A, 30 VDC	
	AC solid-state	Type	SCR with G3K-2R2P-1 output module (optional)	
		Max. load	200 mA, 250 VAC	
		Min. load	5 mA	
		Max. inrush	2 A	
		OFF-state leakage current	1 mA max.	
	DC solid-state	Type	NPN-SPDT with G3KD-YR2P-1 output module (optional) PNP-SPDT with G3KD-YR2P-2 output module (optional)	
		Max. load	200 mA, 30 VDC	
		Max. on-stage voltage drop	2 VDC at 200 mA	
Response time (ON and OFF)	Relay	15 ms max. with G6C-2117P-DC8 output module (standard)		
	AC solid-state output	30 ms max. with G3K-2R2P-1 output module (optional)		
	DC solid-state output	1 ms max. with G3KD-YR2P-1 or -2 output modules (optional)		
Timing functions	Type	—	ON-delay, OFF-delay one-shot, equal ON- and OFF-delays, or no timer; switch selectable	Independent ON-delay and OFF-delay
	Range	—	0.1 to 5 seconds	0.1 to 5 seconds
Circuit protection	Output short-circuit	Provided with AC solid-state and DC solid-state output modules only		
	DC power supply reverse polarity	Provided		
Indicators		Light incident (red LED), Output Stability (green LED)	Light incident (red LED), Output Stability (green LED) Output Operation (yellow LED)	
Materials	Lens	Plastic		
	Case	Plastic		
Mounting		Side surface mount with two through holes; Bracket E39-L34 and hardware included		
Connections	Conduit	1/2-14 NPT		
	Wire	Terminal screws		
Weight		200 g (7.1 oz.)		
Enclosure ratings	UL	1		
	NEMA	1, 4, 4X, 12		
	IEC 144	IP66		
Approvals	UL	Listed, File Number E41515		
	CSA	—		
Ambient temperature	Operating	-25° to 55°C (-13° to 131°F)		
	Storage	-30° to 70°C (-22° to 158°F)		

OUTPUT CIRCUIT DIAGRAMS

Relay output

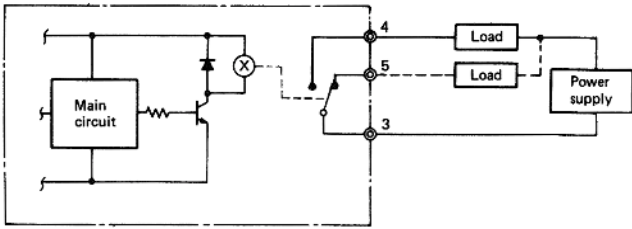

AC solid-state output

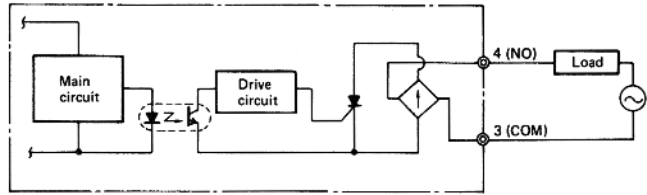

DC solid-state PNP output

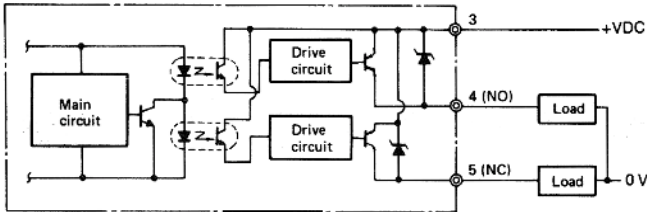

DC solid-state NPN output

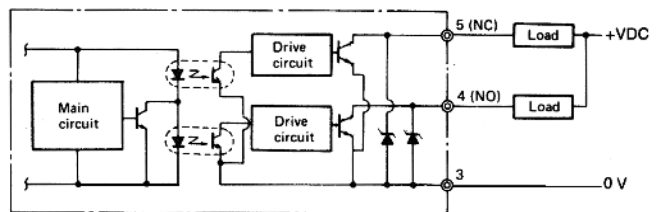

CONNECTIONS

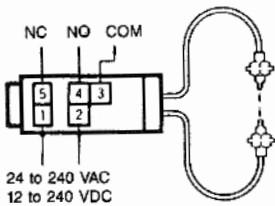

TIMING CHARTS

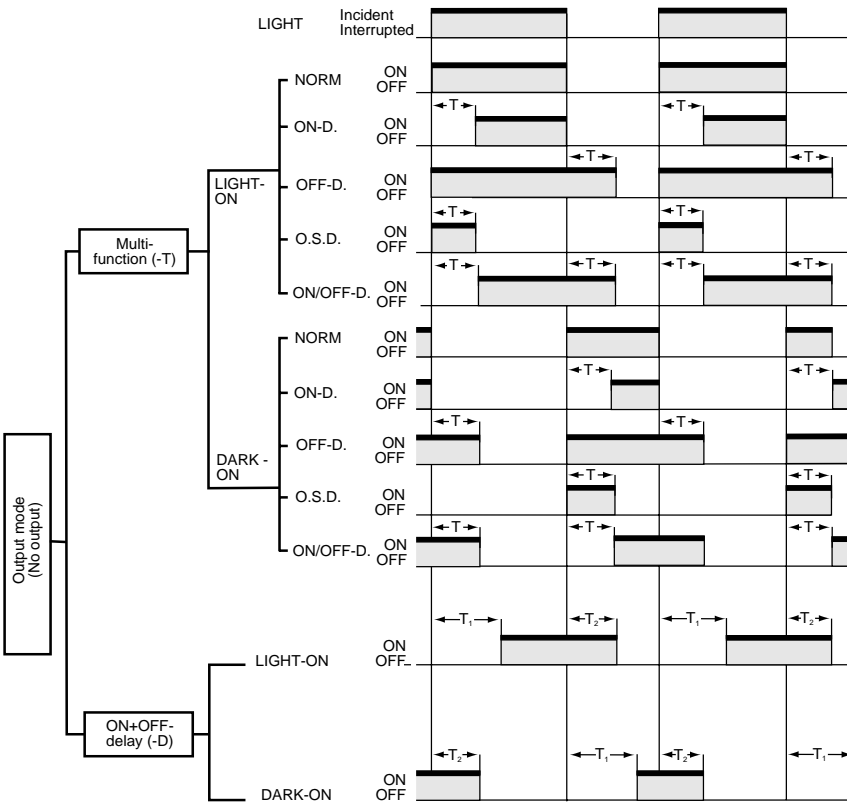

- Note:
1. For E3A2-XCM4 amplifier without built-in timer functions, operation follows the NORM mode shown with multi-function time delay model.
 2. T_1 , T_2 and T denote set time, variable within 0.1 to 5 second range.
 3. For multi-function time delay model (E3A2-XCM4T), the ON- and OFF-delay time settings will be the same for T_1 and T_2 .
 4. For ON- and OFF-delay model (E3A2-XCM4D), T_1 and T_2 are independently variable.

Dimensions

Unit: mm (inch)

■ AMPLIFIERS

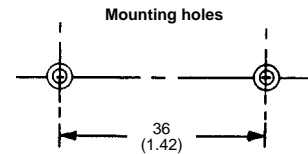
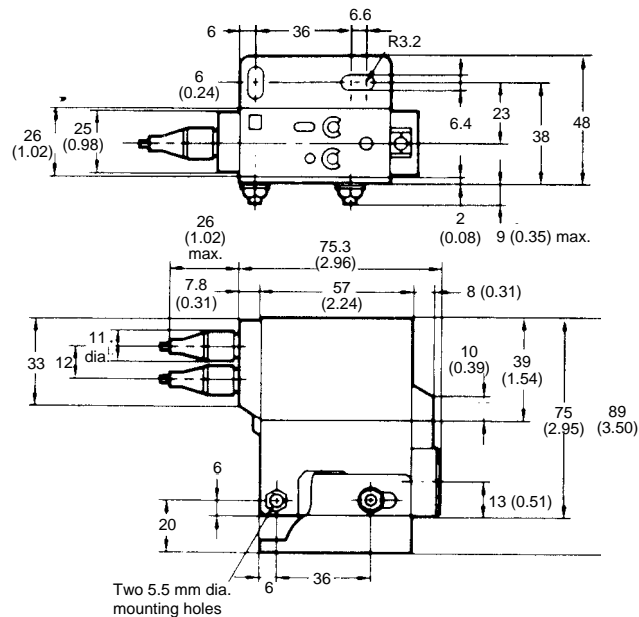
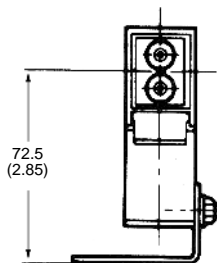
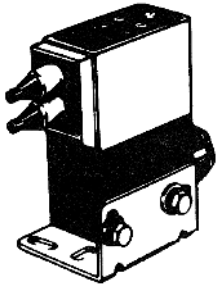

■ FIBER-OPTIC CABLES

Refer to E32 data sheet for dimensions of plastic fiber-optic cables and accessories.

OMRON

OMRON ELECTRONICS LLC

One East Commerce Drive
Schaumburg, IL 60173

1-800-55-OMRON

OMRON ON-LINE

Global - <http://www.omron.com>
USA - <http://www.omron.com/oei>
Canada - <http://www.omron.com/oci>

OMRON CANADA, INC.

885 Milner Avenue
Scarborough, Ontario M1B 5V8
416-286-6465