

bq30z50-R1 and bq30z55-R1

Technical Reference



Literature Number: SLUU852A
January 2012–Revised December 2015

Preface	9
1 Introduction	11
2 Calibration	13
2.1 Overview	13
2.2 Combining Calibrations	14
2.3 Cell Voltage Calibration	15
2.4 BAT Voltage Calibration	16
2.5 PACK Voltage Calibration	16
2.6 Current Calibration	17
2.6.1 Offset Calibration	17
2.6.2 Board Offset Calibration	17
2.6.3 Gain Calibration	18
2.7 Temperature Calibration	18
2.7.1 Internal Temperature Sensor Calibration (Option 1)	18
2.7.2 Internal Temperature Sensor Calibration (Option 2)	19
2.7.3 TS1 Calibration (Option 1)	19
2.7.4 TS1 Calibration (Option 2)	19
2.7.5 TS2 Calibration (Option 1)	20
2.7.6 TS2 Calibration (Option 2)	20
2.7.7 TS3 Calibration (Option 1)	21
2.7.8 TS3 Calibration (Option 2)	21
2.7.9 TS4 Calibration (Option 1)	21
2.7.10 TS4 Calibration (Option 2)	21
3 Protections	23
3.1 Introduction	23
3.2 Cell Undervoltage Protection	23
3.3 Cell Undervoltage Compensated Protection	23
3.4 Cell Overvoltage Protection	24
3.5 Overcurrent in Charge Protection	25
3.6 Overcurrent in Discharge Protection	25
3.7 Hardware-Based Protection	26
3.7.1 Overload in Discharge Protection	26
3.7.2 Short Circuit in Charge Protection	27
3.7.3 Short Circuit in Discharge Protection	27
3.8 Overtemperature in Charge Protection	28
3.9 Overtemperature in Discharge Protection	28
3.10 Overtemperature FET Protection	28
3.11 SBS Host Watchdog Protection	29
3.12 Pre-Charge Timeout Protection	29
3.13 Fast Charge Timeout Protection	30
3.14 Overcharge Protection	30
3.15 Over-Charging Voltage() Protection	30
3.16 Over-Charging Current() Protection	31
4 Advanced Charge Algorithm	32

4.1	Introduction	32
4.2	Charge Temperature Ranges	32
4.3	Voltage Range	33
4.4	Charging Current	33
4.5	Charging Voltage	34
4.6	Valid Charge Termination	34
4.7	Charge Inhibit	34
4.8	Charge Suspend	35
4.9	ChargingVoltage() Rate of Change	35
4.10	ChargingCurrent() Rate of Change	35
4.11	Charging Loss Compensation	35
5	Permanent Fail	38
5.1	Introduction	38
5.2	Black Box Recorder	38
5.3	Cell Undervoltage Permanent Fail	39
5.4	Cell Overvoltage Permanent Fail	39
5.5	Copper Deposition Permanent Fail	39
5.6	Overtemperature Cell Permanent Fail	40
5.7	Overtemperature FET Permanent Fail	40
5.8	QMax Imbalance Permanent Fail	40
5.9	Cell Balancing Permanent Fail	40
5.10	Capacity Degradation Permanent Fail	41
5.11	Impedance Permanent Fail	41
5.12	Voltage Imbalance at Rest Permanent Fail	41
5.13	Voltage Imbalance Active Permanent Fail	42
5.14	Charge FET Permanent Fail	42
5.15	Discharge FET Permanent Fail	42
5.16	Thermistor Permanent Fail	42
5.17	Chemical Fuse Permanent Fail	43
5.18	AFE Register Permanent Fail	43
5.19	AFE Communication Permanent Fail	43
5.20	Second Level Protection Permanent Fail	43
5.21	PTC Permanent Fail	44
5.22	Instruction Flash Checksum Permanent Fail	44
5.23	Open Cell Voltage Connection Permanent Fail	44
5.24	Data Flash Permanent Fail	44
6	Power Modes	47
6.1	NORMAL Mode	47
6.2	SLEEP Mode	47
6.2.1	Device Sleep	47
6.2.2	ManufacturerAccess Sleep	48
6.3	SHIP Mode	48
6.3.1	SHIP HIBERNATE Mode	48
6.3.2	SHIP SHUTDOWN Mode	48
6.4	SHUTDOWN Mode	48
6.4.1	Voltage Based Shutdown	48
7	Gauging	50
7.1	Impedance Track	50
7.2	Gas Gauge Mode	50
8	LED Display	52
8.1	LED Display State of Charge	52
8.2	LED Display PF Codes	53

9	Lifetime Data Collection	55
10	Device Security	58
10.1	Description	58
10.2	SHA-1 Description.....	58
10.3	HMAC Description.....	58
10.4	Authentication.....	58
10.5	Unseal/Full Access.....	59
11	SBS Commands	61
11.1	0x00 ManufacturerAccess().....	61
11.1.1	0x0000 ManufacturerData	61
11.1.2	0x0001 Device Type	61
11.1.3	0x0002 Firmware Version	61
11.1.4	0x0003 Hardware Version	62
11.1.5	0x0004 Instruction Flash Checksum.....	62
11.1.6	0x0005 Data Flash Checksum	62
11.1.7	0x0006 Chemical ID	62
11.1.8	0x0010 Shutdown Mode	62
11.1.9	0x0011 Sleep Mode.....	62
11.1.10	0x0012 Device Reset	63
11.1.11	0x001d Fuse Toggle	63
11.1.12	0x001e PRE-CHG FET	63
11.1.13	0x001f CHG FET	64
11.1.14	0x0020 DSG FET.....	64
11.1.15	0x0021 Gauging	64
11.1.16	ManufacturerAccess() 0x0022 FET Control.....	64
11.1.17	ManufacturerAccess() 0x0023 Lifetime Data Collection.....	64
11.1.18	ManufacturerAccess() 0x0024 Permanent Failure	65
11.1.19	ManufacturerAccess() 0x0025 Black Box Recorder	65
11.1.20	ManufacturerAccess() 0x0026 Fuse	65
11.1.21	ManufacturerAccess() 0x0027 LED Enable.....	65
11.1.22	ManufacturerAccess() 0x0028 Lifetime Data Reset.....	65
11.1.23	ManufacturerAccess() 0x0029 Permanent Fail Data Reset.....	65
11.1.24	ManufacturerAccess() 0x002A Black Box Recorder Reset	66
11.1.25	ManufacturerAccess() 0x002B LED Toggle.....	66
11.1.26	ManufacturerAccess() 0x002C LED Display On.....	66
11.1.27	ManufacturerAccess() 0x002D CAL Mode	66
11.1.28	ManufacturerAccess() 0x0030 Seal Device	66
11.1.29	ManufacturerAccess() 0x0031 UnSeal Device	66
11.1.30	ManufacturerAccess() 0x0032 Full Access Device	67
11.1.31	ManufacturerAccess() 0x0033 ROM Mode	67
11.1.32	ManufacturerAccess() 0x0034 SHIP Mode	67
11.1.33	ManufacturerAccess() 0x0035 Unseal Key	68
11.1.34	ManufacturerAccess() 0x0036 Full Access Key	68
11.1.35	ManufacturerAccess() 0x0037 Authentication Key.....	68
11.1.36	ManufacturerAccess() 0x0050 SafetyAlert	69
11.1.37	ManufacturerAccess() 0x0051 SafetyStatus	69
11.1.38	ManufacturerAccess() 0x0052 PFAAlert	69
11.1.39	ManufacturerAccess() 0x0053 PFStatus	69
11.1.40	ManufacturerAccess() 0x0054 OperationStatus	69
11.1.41	ManufacturerAccess() 0x0055 ChargingStatus.....	69
11.1.42	ManufacturerAccess() 0x0056 GaugingStatus	70
11.1.43	ManufacturerAccess() 0x0057 ManufacturingStatus.....	70
11.1.44	ManufacturerAccess() 0x0058 AFE Register	70

11.1.45	ManufacturerAccess() 0x0060 Lifetime Data Block 1.....	70
11.1.46	ManufacturerAccess() 0x0061 Lifetime Data Block 2.....	70
11.1.47	ManufacturerAccess() 0x0062 Lifetime Data Block 3.....	70
11.1.48	ManufacturerAccess() 0x0070 ManufacturerInfo.....	70
11.1.49	ManufacturerAccess() 0x0071 Voltages.....	71
11.1.50	ManufacturerAccess() 0x0072 Temperatures.....	71
11.1.51	ManufacturerAccess() 0x0073 ITSTATUS1.....	71
11.1.52	ManufacturerAccess() 0x0074 ITSTATUS2.....	71
11.1.53	ManufacturerAccess() 0xF080 Exit Calibration Output Mode.....	71
11.1.54	ManufacturerAccess() 0xF081 Output CC and ADC for Calibration.....	71
11.1.55	ManufacturerAccess() 0xF082 Output Shorted CC AND ADC Offset for Calibration.....	72
11.1.56	ManufacturerAccess() 0x01yy DF Access Row Address.....	73
11.2	0x01 RemainingCapacityAlarm().....	73
11.3	0x02 RemainingTimeAlarm().....	73
11.4	0x03 BatteryMode().....	74
11.5	0x04 AtRate().....	74
11.6	0x05 AtRateToFull().....	74
11.7	0x06 AtRateToEmpty().....	75
11.8	0x07 AtRateOK().....	75
11.9	0x08 Temperature().....	75
11.10	0x09 Voltage().....	75
11.11	0x0A Current().....	75
11.12	0x0B AverageCurrent().....	75
11.13	0x0C MaxError().....	75
11.14	0x0D RelativeStateOfCharge().....	76
11.15	0x0E AbsoluteStateOfCharge().....	76
11.16	0x0F RemainingCapacity().....	76
11.17	0x10 FullChargeCapacity().....	76
11.18	0x11 RunTimeToEmpty().....	76
11.19	0x12 AverageTimeToEmpty().....	77
11.20	0x13 AverageTimeToFull().....	77
11.21	0x14 ChargingCurrent().....	77
11.22	0x15 ChargingVoltage().....	77
11.23	0x16 BatteryStatus().....	78
11.24	0x17 CycleCount().....	79
11.25	0x18 DesignCapacity().....	79
11.26	0x19 DesignVoltage().....	79
11.27	0x1A SpecificationInfo().....	79
11.28	0x1B ManufacturerDate().....	80
11.29	0x1C SerialNumber().....	80
11.30	0x20 ManufacturerName().....	80
11.31	0x21 DeviceName().....	81
11.32	0x22 DeviceChemistry().....	81
11.33	0x23 ManufacturerData().....	81
11.34	0x2F Authentication() AND ManufacturerInput().....	81
11.35	0x3C–0x3F Cell Voltages().....	81
11.36	0x50 SafetyAlert().....	82
11.37	0x51 SafetyStatus().....	84
11.38	0x52 PFAAlert().....	86
11.39	0x53 PFStatus().....	88
11.40	0x54 OperationStatus().....	90
11.41	0x55 ChargingStatus().....	92
11.42	0x56 GaugingStatus().....	93

11.43	0x57 ManufacturingStatus()	93
11.44	0x58 AFERegisters()	94
11.45	0x60 Lifetime Data Block 1	95
11.46	0x61 Lifetime Data Block 2	96
11.47	0x62 Lifetime Data Block 3	96
11.48	0x70 ManufacturerInfo()	97
11.49	0x71 Voltages()	97
11.50	0x72 Temperatures()	97
11.51	0x73 ITStatus1()	97
11.52	0x74 ITStatus2()	98
12	Data Flash Values and Device Configuration	102
12.1	Data Formats	102
12.1.1	Unsigned Integer	102
12.1.2	Integer	102
12.1.3	Floating Point	102
12.1.4	Hex	102
12.1.5	String	102
12.2	Protections	102
12.2.1	CUV—Cell Undervoltage	102
12.2.2	CUVC—Cell Undervoltage Compensated	103
12.2.3	COV—Cell Overvoltage	103
12.2.4	OCC1—Overcurrent In Charge 1	103
12.2.5	OCC2—Overcurrent In Charge 2	104
12.2.6	OCC Overcurrent In Charge Recovery	104
12.2.7	OCD1—Overcurrent In Discharge 1	104
12.2.8	OCD2—Overcurrent In Discharge 2	104
12.2.9	OCD—Overcurrent In Discharge Recovery	104
12.2.10	OLD—Overload in Discharge	105
12.2.11	SCC—Short Circuit In Charge	105
12.2.12	SCD1—Short Circuit In Discharge 1	105
12.2.13	SCD2—Short Circuit in Discharge 2	105
12.2.14	SCD—Short Circuit in Discharge	106
12.2.15	OTC—Over Temperature in Charge	106
12.2.16	OTD—Over Temperature in Discharge	106
12.2.17	OTF—Over Temperature FET	107
12.2.18	HWD—Host Watchdog	107
12.2.19	PTO—Pre Charge Mode Time Out	107
12.2.20	CTO—Fast Charge Mode Time Out	107
12.2.21	OC—Over Charge	107
12.2.22	CHGV—ChargingVoltage	107
12.2.23	CHGC—ChargingCurrent	108
12.3	Permanent Fail	108
12.3.1	CUV—Cell Undervoltage	108
12.3.2	COV—Cell Overvoltage	108
12.3.3	CUDEP—Copper Deposition	108
12.3.4	OTCE—Over Temperature Cell	108
12.3.5	OTF—Over Temperature FET	108
12.3.6	QIM—QMax Imbalance	109
12.3.7	CB—Cell Balance	109
12.3.8	VIMR—Voltage Imbalance at Rest	109
12.3.9	VIMA—Voltage Imbalance Active	109
12.3.10	IMP—Impedance Imbalance	109
12.3.11	CD—Capacity Degradation	110

12.3.12	CFETF—CHG FET Failure	110
12.3.13	DFET—DFET Failure	110
12.3.14	TH—NTC Thermistor Failure	110
12.3.15	FUSE—FUSE Failure.....	110
12.3.16	AFER—AFE Register.....	110
12.3.17	AFEC—AFE Communication	111
12.3.18	2LVL—2nd Level OV	111
12.3.19	OCECO—Open Cell Connection.....	111
12.4	Advanced Charge Algorithm	111
12.4.1	Temperature Ranges.....	111
12.4.2	Low Temp Charging.....	111
12.4.3	Standard Temp Charging.....	112
12.4.4	High Temp Charging	112
12.4.5	REC Temp Charging	112
12.4.6	PCHG	113
12.4.7	MCHG	113
12.4.8	Voltage Range	113
12.4.9	Termination Config	113
12.4.10	Cell Balancing Config.....	113
12.4.11	Charging Rate of Change	114
12.4.12	Charge Loss Compensation	114
12.5	System Data	114
12.5.1	Manufacturer Data.....	114
12.6	SBS Configuration	115
12.6.1	Data	115
12.6.2	FD.....	116
12.6.3	FC.....	116
12.6.4	TDA	116
12.6.5	TCA	117
12.6.6	Max Error	117
12.7	Lifetimes	117
12.7.1	Voltage	117
12.7.2	Current	117
12.7.3	Safety Events	117
12.7.4	Charging Events	118
12.7.5	Gauging Events	118
12.7.6	Power Events	119
12.7.7	Cell Balancing	119
12.7.8	Temperature.....	119
12.7.9	Time	119
12.8	Settings.....	120
12.8.1	Fuse	120
12.8.2	Manufacturing	122
12.8.3	Protection	123
12.8.4	Permanent Failure	124
12.8.5	Configuration	125
12.8.6	AFE	131
12.9	Power.....	132
12.9.1	Power.....	132
12.9.2	Shutdown	132
12.9.3	Sleep	132
12.9.4	Ship.....	132
12.10	Gas Gauging	133

12.10.1	Current Thresholds.....	133
12.10.2	State	133
12.11	IT Config	133
12.12	LED Config	135
12.13	RA Table.....	136
12.13.1	R_a0	136
12.13.2	R_a1	136
12.13.3	R_a2	137
12.13.4	R_a3	137
12.13.5	R_a0x	138
12.13.6	R_a1x	139
12.13.7	R_a2x	139
12.13.8	R_a3x	140
12.14	PF Status	140
12.14.1	Device Status Data	140
12.14.2	Device Voltage Data	150
12.14.3	Device Current Data	150
12.14.4	Device Temperature Data.....	151
12.14.5	Device Gauging Data	151
12.14.6	AFE Regs	151
12.15	Black Box.....	155
12.15.1	Safety Status.....	155
12.15.2	PF Status.....	159
12.16	Calibration	166
12.16.1	Voltage.....	166
12.16.2	Current.....	166
12.16.3	Current Offset.....	166
12.16.4	Temperature	166
12.16.5	Internal Temp Model	166
12.16.6	Cell Temp Model	167
12.16.7	FET Temp Model.....	167
12.16.8	Filter.....	168
12.16.9	Current Deadband	168
A	AFE Threshold and Delay Settings.....	170
A.1	Overload in Discharge Protection (OLD)	170
A.2	Short Circuit in Charge (SCC)	171
A.3	Short Circuit in Discharge (SCD1 and SCD2)	171
B	Reading and Writing to Data Flash.....	174
C	Sample Filter Settings	210
	Revision History	211

Preface

Read this First

This manual discusses the modules and peripherals of the bq30z50-R1 and bq30z55-R1 devices, and how each is used to build a complete battery pack gas gauge and protection solution.

Notational Conventions

The following notation is used, if SBS commands and data flash values are mentioned within a text block:

- SBS commands are set in italic; for example, *Voltage*.
- SBS bits and flags are capitalized, set in italic and enclosed with square brackets; for example, *[TCA]*.
- Data flash values are set in bold italic; for example, ***CUV Threshold***.
- All data flash bits and flags are capitalized, set in bold italic and enclosed with square brackets, for example, ***[NR]***.

All SBS commands, data flash values, and flags mentioned in a chapter are listed at the end of each chapter for reference.

The reference format for SBS commands is: SBS:Command Name(Command No.):Manufacturer Access(MA No.)[Flag], for example:

SBS:Voltage(0x09), or SBS:ManufacturerAccess(0x00):Seal Device(0x0020)

The reference format for data flash values is: DF:Class Name:Subclass Name(Subclass ID):Value Name(Offset)[Flag], for example:

DF:1st Level Safety:Voltage(576):CUV Threshold(13), or

DF:ChargeControl:ChargingFaults(482)Charge Fault Cfg(8)[OC].

Trademarks

Impedance Track is a trademark of Texas Instruments. All other trademarks are the property of their respective owners.

Introduction

The bq30z50-R1 and bq30z55-R1 devices provide a feature-rich gas gauging solution for 2-series cell to 4-series cell battery-pack applications. The device has extended capabilities, including:

- SBS Data Updates Every 250 ms; Values Are Filtered, Not Averaged
- Unseal via Authentication with Keys in IF, Enhanced Security
- Advanced Impedance Track™ Algorithm v3.75 with Cell Balancing During Rest
- Fast Host-Side Calibration
- Fast Qmax Learning
- Independent Function Enable/Disable: FET, IT, BB, LT, PF, FUSE, LED
- Cell and FET Temperature Configuration Options and up to Five Independently Selectable Sources for Each Option
- Manufacturer Access Commands for Test: Fuse, FET, LED, Toggle
- Extended Lifetimes Tracking
- Black Box Recorder

Calibration

2.1 Overview

The device has integrated routines that support calibration of current, voltage, and temperature readings, accessible after writing 0xF080 to 0xF082 to *ManufacturerAccess()*. When the calibration routines are activated, the *ManufacturerStatus()[CAL]* flag is set, and raw ADC data is available on *ManufacturerData()*.

<i>ManufacturerAccess()</i>	Description
0xF02D	Enable/Disable CALIBRATION mode in <i>ManufacturingStatus()</i>
0xF080	Disable raw ADC data output on <i>ManufacturerData()</i>
0xF081	Output raw ADC data of voltage, current, and temperature on <i>ManufacturerData()</i>
0xF082	Output raw ADC data of voltage, current, and temperature on <i>ManufacturerData()</i> . This mode includes a shunt of the coulomb counter input.

The *ManufacturerData()* output format is: ZZYYaaAAabbBBccCCddDDeeEEffFFggGGhhHHiiiJJkkKKllLL, where:

Value	Format	Description
ZZ	byte	8-bit counter, increments when raw ADC values are refreshed, typically every 250 ms
YY	byte	Output status <i>ManufacturerAccess()</i> = 0xF081: 1 <i>ManufacturerAccess()</i> = 0xF082: 2
AAaa	2's comp	<i>ManufacturerAccess()</i> = 0xF081: coulomb counter <i>ManufacturerAccess()</i> = 0xF082: internal shorted coulomb counter
BBbb	2's comp	Cell Voltage 1
CCcc	2's comp	Cell Voltage 2
DDdd	2's comp	Cell Voltage 3
EEee	2's comp	Cell Voltage 4
FFff	2's comp	Internal temperature sensor
GGgg	2's comp	Temperature Sensor 1
HHhh	2's comp	Temperature Sensor 2
Iiii	2's comp	Temperature Sensor 3
JJjj	2's comp	Temperature Sensor 4
KKkk	2's comp	PACK Voltage
LLll	2's comp	BAT Voltage

2.2 Combining Calibrations

Calibrations can be combined to shorten calibration time. Calibration times under four seconds are achievable using this method.

Table 2-1. Combining Calibrations

Time (s)	ZZ in <i>ManufacturerData()</i>	Action
0	N	<ul style="list-style-type: none"> • Read DF values • Apply 0 mA current • Apply cell voltages • Apply known temperature • <i>ManufacturerAccess()</i> = 0xF082 • Poll <i>ManufacturerData()</i> for ZZ increment
0.25	N + 1	<ul style="list-style-type: none"> • Poll <i>ManufacturerData()</i> for ZZ increment
0.5	N + 2	<ul style="list-style-type: none"> • Store <i>ManufacturerData()</i> block 1 • Poll <i>ManufacturerData()</i> for ZZ increment
0.75	N + 3	<ul style="list-style-type: none"> • Store <i>ManufacturerData()</i> block 2 • Poll <i>ManufacturerData()</i> for ZZ increment
1	N + 4	<ul style="list-style-type: none"> • Store <i>ManufacturerData()</i> block 3 • Poll <i>ManufacturerData()</i> for ZZ increment
1.25	N + 5	<ul style="list-style-type: none"> • Store <i>ManufacturerData()</i> block 4 • Apply Pack Voltage • <i>ManufacturerAccess()</i> = 0xF081 • Poll <i>ManufacturerData()</i> for ZZ increment
1.5	N + 6	<ul style="list-style-type: none"> • Poll <i>ManufacturerData()</i> for ZZ increment
1.75	N + 7	<ul style="list-style-type: none"> • Store <i>ManufacturerData()</i> block 5 • Poll <i>ManufacturerData()</i> for ZZ increment
2	N + 8	<ul style="list-style-type: none"> • Store <i>ManufacturerData()</i> block 6 • Poll <i>ManufacturerData()</i> for ZZ increment
2.25	N + 9	<ul style="list-style-type: none"> • Store <i>ManufacturerData()</i> block 7 • Poll <i>ManufacturerData()</i> for ZZ increment
2.5	N + 10	<ul style="list-style-type: none"> • Store <i>ManufacturerData()</i> block 8 • Apply calibration current • Poll <i>ManufacturerData()</i> for ZZ increment
2.75	N + 11	<ul style="list-style-type: none"> • Poll <i>ManufacturerData()</i> for ZZ increment
3	N + 12	<ul style="list-style-type: none"> • Store <i>ManufacturerData()</i> block 9 • Poll <i>ManufacturerData()</i> for ZZ increment
3.25	N + 13	<ul style="list-style-type: none"> • Store <i>ManufacturerData()</i> block 10 • Poll <i>ManufacturerData()</i> for ZZ increment
3.5	N + 14	<ul style="list-style-type: none"> • Store <i>ManufacturerData()</i> block 11 • Poll <i>ManufacturerData()</i> for ZZ increment
3.75	N + 15	<ul style="list-style-type: none"> • Store <i>ManufacturerData()</i> block 12 • Calculate CC Offset using blocks 1 to 4 • Calculate board Offset using blocks 5 to 8 • Calculate current gain using blocks 9 to 12 • Calculate Cell Voltage 1–4 using blocks 1 to 4 • Calculate Pack Voltage using blocks 5 to 8 • Calculate Temperatures using blocks 5 to 8 • Write values to data flash

2.3 Cell Voltage Calibration

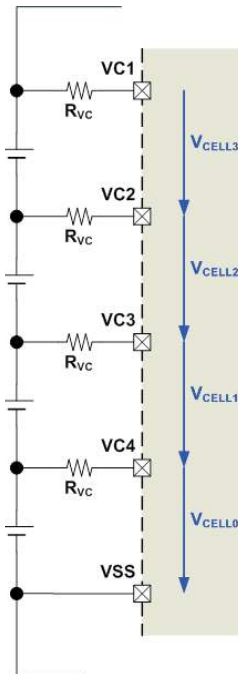

- Apply known voltages in mV to the cell voltage inputs:
 - V_{CELL0} between VC4 pin and VSS pin
 - V_{CELL1} between VC3 pin and VC4 pin
 - V_{CELL2} between VC2 pin and VC3 pin
 - V_{CELL3} between VC1 pin and VC2 pin
- Send 0xF081 or 0xF082 to *ManufacturerAccess()* to enable raw cell voltage output on *ManufacturerData()*.
- Poll *ManufacturerData()* until ZZ increments by 2 before reading data.
- Grab the ADC conversion readings of cell voltages from *ManufacturerData()*:
 - $ADC_{CELL0} = \text{AAAA of } ManufacturerData(),$ is $ADC_{CELL0} < 0x8000?$ If yes, use ADC_{CELL0} ; otherwise, $ADC_{CELL0} = \text{AAAA} - 0xFFFF + 0x0001$
 - $ADC_{CELL1} = \text{BBBB of } ManufacturerData(),$ is $ADC_{CELL1} < 0x8000?$ If yes, use ADC_{CELL1} ; otherwise, $ADC_{CELL1} = \text{BBBB} - 0xFFFF + 0x0001$
 - $ADC_{CELL2} = \text{CCCC of } ManufacturerData(),$ is $ADC_{CELL2} < 0x8000?$ If yes, use ADC_{CELL2} ; otherwise, $ADC_{CELL2} = \text{CCCC} - 0xFFFF + 0x0001$
 - $ADC_{CELL3} = \text{DDDD of } ManufacturerData(),$ is $ADC_{CELL3} < 0x8000?$ If yes, use ADC_{CELL3} ; otherwise, $ADC_{CELL3} = \text{DDDD} - 0xFFFF + 0x0001$
- Average several readings for higher accuracy. Poll *ManufacturerData()* until ZZ increments, which indicates updated values.
- Calculate gain values:
$$Cell\ Scale\ 0 = \frac{V_{CELL0}}{ADC_{CELL0}} * 2^{16}$$

$$Cell\ Scale\ 1 = \frac{V_{CELL0} + V_{CELL1}}{ADC_{CELL0} + ADC_{CELL1}} * 2^{16} \quad Cell\ Scale\ 2 = \frac{V_{CELL0} + V_{CELL1} + V_{CELL2}}{ADC_{CELL0} + ADC_{CELL1} + ADC_{CELL2}} * 2^{16}$$

$$Cell\ Scale\ 3 = \frac{V_{CELL0} + V_{CELL1} + V_{CELL2} + V_{CELL3}}{ADC_{CELL0} + ADC_{CELL1} + ADC_{CELL2} + ADC_{CELL3}} * 2^{16}$$
- Update the data flash with Cell Scale 0, Cell Scale 1, Cell Scale 2, Cell Scale 3.

8. Re-check the voltage reading. Repeat the steps if the readings are not accurate.

2.4 BAT Voltage Calibration

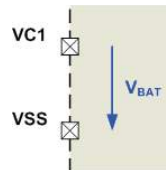

1. Apply known voltages in mV to the voltage input:
 - V_{BAT} between VC4 pin and VSS pin
2. Enter CALIBRATION mode if *ManufacturerStatus()[CAL] = 0*, send 0x002D to *ManufacturerAccess()*
3. Send 0xF081 or 0xF082 to *ManufacturerAccess()* to enable raw cell voltage output on *ManufacturerData()*.
4. Poll *ManufacturerData()* until ZZ increments by 2 before reading data.
5. Grab ADC conversion readings of cell stack voltage from *ManufacturerData()*:
 - $ADC_{BAT} = \text{LLII of } ManufacturerData(), \text{ is } ADC_{BAT} < 0x8000? \text{ If yes use } ADC_{BAT}, \text{ otherwise } ADC_{BAT} = \text{LLII} - 0xFFFF - 0x0001$
6. To average several readings for higher accuracy, poll *ManufacturerData()* until ZZ increments, which indicates updated values.
 - $ADC_{BAT} = [ADC_{BAT}(\text{reading } n) + \dots + ADC_{BAT}(\text{reading } 1)]/n$
7. Calculate gain value:

$$BAT \text{ Gain} = \frac{V_{BAT}}{ADC_{BAT}} \times 2^{16}$$
8. Update data flash with **BAT Gain**.
9. Re-check the voltage reading, and repeat steps if the readings are not accurate.
10. Exit CALIBRATION mode by sending 0x002D to *ManufacturerAccess()* or continue with calibration.

2.5 PACK Voltage Calibration

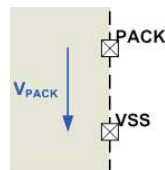

1. Apply known voltages in mV to the voltage input:
 - V_{PACK} between PACK pin and VSS pin
2. Enter CALIBRATION mode if *ManufacturerStatus()[CAL] = 0*, send 0x002D to *ManufacturerAccess()*.
3. Send 0xF081 or 0xF082 to *ManufacturerAccess()* to enable raw cell voltage output on *ManufacturerData()*.
4. Poll *ManufacturerData()* until ZZ increments by 2 before reading data.
5. Grab ADC conversion readings of pack voltage from *ManufacturerData()*:
 - $ADC_{PACK} = \text{KKkk of } ManufacturerData(), \text{ is } ADC_{PACK} < 0x8000? \text{ If yes, use } ADC_{PACK}, \text{ otherwise } ADC_{PACK} = \text{KKkk} - 0xFFFF - 0x0001.$
6. To average several readings for higher accuracy, poll *ManufacturerData()* until ZZ increments, which indicates updated values.
 - $ADC_{PACK} = [ADC_{PACK}(\text{reading } n) + \dots + ADC_{PACK}(\text{reading } 1)]/n$

- Calculate gain value:

$$PACK\ Gain = \frac{V_{PACK}}{ADC_{PACK}} \times 2^{16}$$

- Update data flash with **PACK Gain**.
- Re-check voltage reading; repeat Steps 4 to 6 if readings are not accurate.
- Exit CALIBRATION mode by sending 0x002D to *ManufacturerAccess()* or continue with calibration.

2.6 Current Calibration

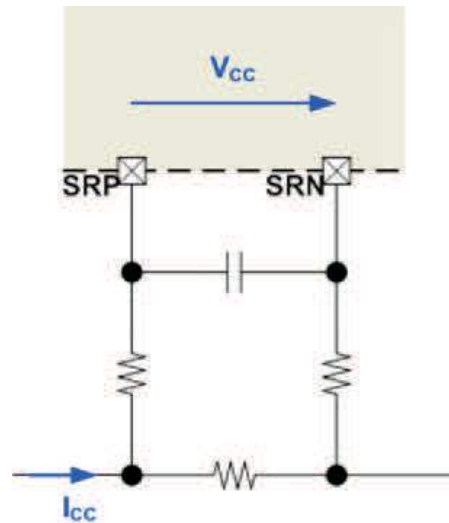

2.6.1 Offset Calibration

- Apply a known current of 0 mA:
 - Make sure no current is flowing through the sense resistor connected between the SRP and SRN pins.
- Send 0xF082 to *ManufacturerAccess()* to enable raw CC output on *ManufacturerData()* with CC shunt.
- Read *Coulomb Counter Offset Samples* from data flash.
- Poll *ManufacturerData()* until ZZ increments by 2 before reading data.
- Grab the ADC conversion readings of current from *ManufacturerData()*:
 - $ADC_{CC} = A\text{Aaa}$ of *ManufacturerData()*, is $ADC_{CC} < 0x8000$? If yes, use ADC_{CC} ; otherwise, $ADC_{CC} = A\text{Aaa} - 0xFFFF - 0x0001$.
- To average several readings for higher accuracy, poll *ManufacturerData()* until ZZ increments, which indicates updated values.
 - $ADC_{CC} = [ADC_{CC}(\text{reading } n) + \dots + ADC_{CC}(\text{reading } 1)]/n$
- Calculate offset value:
$$CC\ offset = ADC_{CC} * (\text{Coulomb Counter Offset Samples})$$
- Update the data flash with *CC Offset*.
- Re-check the current reading. Repeat the steps if the readings are not accurate.

2.6.2 Board Offset Calibration

- Apply a known current of 0 mA:
 - Make sure no current is flowing through the sense resistor connected between SRP pin and SRN pin.
- Send 0xF081 to *ManufacturerAccess()* to enable raw CC output on *ManufacturerData()*.
- Read *Coulomb Counter Offset Samples* from data flash.

4. Poll *ManufacturerData()* until ZZ increments by 2 before reading data.
5. Grab the ADC conversion readings of current from *ManufacturerData()*:
 - $ADC_{CC} = \text{AAaa of } ManufacturerData(), \text{ is } ADC_{CC} < 0x8000? \text{ If yes, use } ADC_{CC}; \text{ otherwise, } ADC_{CC} = \text{AAaa} - 0xFFFF - 0x0001.$
6. To average several readings for higher accuracy, poll *ManufacturerData()* until ZZ increments, which indicates updated values.
 - $ADC_{CC} = [ADC_{CC}(\text{reading } n) + \dots + ADC_{CC}(\text{reading } 1)]/n$
7. Calculate offset value:
 $Board\ offset = (ADC_{cc} - CC\ Offset / (Coulomb\ Counter\ Offset\ Samples)) * (Coulomb\ Counter\ Offset\ Samples)$
8. Update the data flash with *Board Offset*.
9. Re-check the current reading. Repeat the steps if the readings are not accurate.

2.6.3 Gain Calibration

1. Apply a known current in mA to the current input.
 - Make sure current I_{CC} is flowing through the sense resistor connected between SRP pin and SRN pin.
2. Send 0xF081 to *ManufacturerAccess()* to enable raw CC output on *ManufacturerData()*.
3. Read *Coulomb Counter Offset Samples* from data flash.
4. Poll *ManufacturerData()* until ZZ increments by 2 before reading data.
5. Grab the ADC conversion readings of current from *ManufacturerData()*:
 - $ADC_{CC} = \text{AAaa of } ManufacturerData(), \text{ is } ADC_{CC} < 0x8000? \text{ If yes, use } ADC_{CC}; \text{ otherwise, } ADC_{CC} = \text{AAaa} - 0xFFFF - 0x0001.$
6. To average several readings for higher accuracy, poll *ManufacturerData()* until ZZ increments, which indicates updated values.
 - $ADC_{CC} = [ADC_{CC}(\text{reading } n) + \dots + ADC_{CC}(\text{reading } 1)]/n$
7. Calculate gain values:

$$CC\ Gain = \frac{I_{CC}}{ADC_{CC} - \frac{Board\ Offset + CC\ Offset}{Coulomb\ Counter\ Offset\ Samples}}$$

$$Capacity\ Gain = CC\ Gain \times 298261.6178$$
8. Update the data flash with CC Gain, *Capacity Gain*.
9. Re-check the current reading. Repeat the steps if the readings are not accurate.

2.7 Temperature Calibration

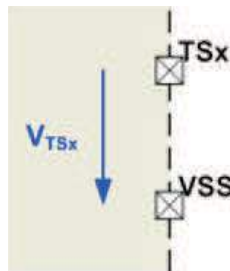

2.7.1 Internal Temperature Sensor Calibration (Option 1)

1. Apply a known temperature in 0.1°C.
 - Make sure temperature $Temp_{TINT}$ is applied to the device.
2. Enable TINT as the SBS temperature source by setting the Misc Configuration bit 7 to 1.
3. Grab the reported temperature from the SBS temperature.

4. Calculate temperature offset:
 $TINT\ offset = TEMP_{TINT} - TINT + TINT\ offset_{old}$
5. Update the data flash with the calculated value.
6. Re-check the current reading. Repeat the steps if the readings are not accurate.

2.7.2 Internal Temperature Sensor Calibration (Option 2)

1. Apply a known temperature in 0.1°C.
 - Make sure temperature $Temp_{TINT}$ is applied to the device.
2. Read *Int Coeff 1*, *Int Coeff 2*, *Int Coeff 3*, *Int Coeff 4* from data flash.
3. Send 0xF081 or 0xF082 to *ManufacturerAccess()* to enable raw cell voltage output on *ManufacturerData()*.
4. Poll *ManufacturerData()* until ZZ increments by 2 before reading data.
5. Grab the ADC conversion readings of temperature from *Temperature()*:
 - $ADC_{TINT} = \text{FFFF of } ManufacturerData(), \text{ is } ADC_{INT} < 0x8000?$ If yes, use ADC_{TINT} ; otherwise, $ADC_{TINT} = \text{FFFF} - 0xFFFF - 0x0001$.
6. To average several readings for higher accuracy, poll *ManufacturerData()* until ZZ increments, which indicates updated values.
 - $ADC_{TINT} = [ADC_{TINT}(\text{reading } n) + \dots + ADC_{TINT}(\text{reading } 1)]/n$
7. Calculate temperature offset:
 $A = ADC_{TINT} / 2^{16}$
 $T_{TINT} = ((INT\ Coeff\ 1) * A^3 + (INT\ Coeff\ 2) * A^2 + (INT\ Coeff\ 3) * A + (INT\ Coeff\ 4)) * 0.1 - 273.15$
 $Internal\ Temperature\ Offset = TEMP_{TINT} - T_{TINT}$
8. Update the data flash with the *Internal Temperature Offset*.
9. Re-check the temperature reading. Repeat the steps if the readings are not accurate.

2.7.3 TS1 Calibration (Option 1)

1. Apply a known temperature in 0.1°C.
 - Make sure temperature $Temp_{TS1}$ is applied to the thermistor connected to the TS1 pin.
2. Enable TS1 as the SBS temperature source by setting the Misc Configuration bit 7 to 0.
3. Grab the reported temperature from the SBS temperature.
4. Calculate the temperature offset:
 $TS1\ offset = TEMP_{TS1} - TS1 + TS1\ offset_{old}$
5. Update the data flash with the calculated value.
6. Re-check the current reading. Repeat the steps if the readings are not accurate.

2.7.4 TS1 Calibration (Option 2)

1. Apply a known temperature in 0.1°C.
 - Make sure temperature $Temp_{TS1}$ is applied to the thermistor connected to the TS1 pin.
2. Read Coeff a1, Coeff a2, Coeff a3, Coeff a4, Coeff b1, Coeff b2, Coeff b3, Coeff b4 from data flash.
3. Send 0xF081 or 0xF082 to *ManufacturerAccess()* to enable raw cell voltage output on *ManufacturerData()*.
4. Poll *ManufacturerData()* until ZZ increments by 2 before reading data.
5. Grab the ADC conversion readings of temperature from *ManufacturerData()*:
 - $ADC_{TS1} = \text{GGgg of } ManufacturerData(), \text{ is } ADC_{TS1} < 0x8000?$ If yes, use ADC_{TS1} ; otherwise, $ADC_{TS1} = \text{GGgg} - 0xFFFF - 0x0001$.
6. To average several readings for higher accuracy, poll *ManufacturerData()* until ZZ increments, which indicates updated values.

$$\bullet \text{ ADC}_{TS1} = [\text{ADC}_{TS1}(\text{reading } n) + \dots + \text{ADC}_{TS1}(\text{reading } 1)]/n$$

7. Calculate temperature offset:

$$A = \frac{\text{ADC}_{TS1}}{2^{15}}$$

$$B = \frac{A}{(\text{Coeff } A1) * A^4 + (\text{Coeff } A2) * A^3 + (\text{Coeff } A3) * A^2 + (\text{Coeff } A4) * A + (\text{Coeff } A5)} * 2^{14}$$

$$T_{TS1} = ((\text{Coeff } B1) * B^3 + (\text{Coeff } B2) * B^2 + (\text{Coeff } B3) * B^1 + (\text{Coeff } B4)) * 0.1 - 273.15$$

$$\text{External 1 Temperature Offset} = \text{TEMP}_{TS1} - T_{TS1}$$

8. Update the data flash with the calculated *External 1 Temperature Offset*.
 9. Re-check the temperature reading. Repeat the steps if the readings are not accurate.

2.7.5 TS2 Calibration (Option 1)

- Apply a known temperature in 0.1°C.
 - Make sure temperature Temp_{TS2} is applied to the thermistor connected to the TS2 pin.
- Enable TS2 by setting the Secondary Thermistor to 1.
- Grab the reported temperature from the extended command 0x7D.
- Calculate temperature offset:

$$\text{TS2 offset} = \text{TEMP}_{TS2} - \text{TS2} + \text{TS2 offset}_{old}$$
- Update the data flash with the calculated value.
- Re-check the current reading. Repeat the steps if the readings are not accurate.

2.7.6 TS2 Calibration (Option 2)

- Apply a known temperature in 0.1°C.
 - Make sure temperature Temp_{TS2} is applied to the thermistor connected to the TS2 pin.
- Read Coeff a1, Coeff a2, Coeff a3, Coeff a4, Coeff b1, Coeff b2, Coeff b3, Coeff b4 from data flash based on TS2 configuration to cell or FET temperature.
- Poll *ManufacturerData()* until ZZ increments by 2 before reading data.
- Grab ADC conversion readings of temperature from *ManufacturerData()*:
 - $\text{ADC}_{TS2} = \text{HHhh}$ of *ManufacturerData()*, is $\text{ADC}_{TS2} < 0x8000$? If yes use ADC_{TS2} , otherwise $\text{ADC}_{TS2} = -(0xFFFF - \text{HHhh} + 0x0001)$
- To average several readings for higher accuracy, poll *ManufacturerData()* until ZZ increments, which indicates updated values.
 - $\text{ADC}_{TS2} = [\text{ADC}_{TS2}(\text{reading } n) + \dots + \text{ADC}_{TS2}(\text{reading } 1)]/n$
- Calculate temperature offset:

$$A = \frac{\text{ADC}_{TS2}}{2^{15}}$$
- $$B = \frac{A}{(\text{Coeff } A1) * A^4 + (\text{Coeff } A2) * A^3 + (\text{Coeff } A3) * A^2 + (\text{Coeff } A4) * A + (\text{Coeff } A5)} * 2^{14}$$
- $$T_{TS2} = ((\text{Coeff } B1) * B^3 + (\text{Coeff } B2) * B^2 + (\text{Coeff } B3) * B^1 + (\text{Coeff } B4)) * 0.1 - 273.15$$
- $$\text{External 2 Temperature Offset} = \text{TEMP}_{TS2} - T_{TS2}$$
- Update the data flash with calculated with **External 2 Temperature Offset**.
- Re-check the temperature reading. Repeat the steps if the readings are not accurate.

2.7.7 TS3 Calibration (Option 1)

1. Apply a known temperature in 0.1°C
 - Make sure temperature $Temp_{TS3}$ is applied to the thermistor connected to the TS3 pin.
2. Enable TS3 by setting the Secondary Thermistor to 1.
3. Grab the reported temperature from the extended command 0x7D.
4. Calculate temperature offset:
 $TS3\ offset = TEMP_{TS3} - TS3 + TS3\ offset_{old}$
5. Update the data flash with the calculated value.
6. Re-check the current reading. Repeat the steps if the readings are not accurate.

2.7.8 TS3 Calibration (Option 2)

1. Apply a known temperature in 0.1°C
 - Make sure temperature $Temp_{TS3}$ is applied to the thermistor connected to the TS3 pin.
2. Read Coeff a1, Coeff a2, Coeff a3, Coeff a4, Coeff b1, Coeff b2, Coeff b3, Coeff b4 from data flash based on TS3 configuration to cell or FET temperature.
3. Poll *ManufacturerData()* until ZZ increments by 2 before reading data.
4. Grab ADC conversion readings of temperature from *ManufacturerData()*:
 - $ADC_{TS3} =$ Iiii of *ManufacturerData()*, is $ADC_{TS3} < 0x8000$? If yes use ADC_{TS3} , otherwise $ADC_{TS3} = Iiii - 0xFFFF - 0x0001$
5. To average several readings for higher accuracy, poll *ManufacturerData()* until ZZ increments that indicates updates values.
 - $ADC_{TS3} = [ADC_{TS3}(\text{reading } n) + \dots + ADC_{TS3}(\text{reading } 1)]/n$
6. Calculate temperature offset:

$$A = \frac{ADC_{TS3}}{2^{15}}$$

$$B = \frac{A}{(CoeffA1)*A^4 + (CoeffA2)*A^3 + (CoeffA3)*A^2 + (CoeffA4)*A + (CoeffA5)} * 2^{14}$$

$$T_{TS3} = ((Coeff B1)*B^3 + (Coeff B2)*B^2 + (Coeff B3)*B^1 + (Coeff B4))*0.1 - 273.15$$

$$External\ 3\ Temperature\ Offset = TEMP_{TS3} - T_{TS3}$$
7. Update the data flash with calculated with **External 3 Temperature Offset**.
8. Re-check the temperature reading. Repeat the steps if the readings are not accurate.

2.7.9 TS4 Calibration (Option 1)

1. Apply a known temperature in 0.1°C
 - Make sure temperature $Temp_{TS4}$ is applied to the thermistor connected to the TS4 pin.
2. Enable TS4 by setting the Secondary Thermistor to 1.
3. Grab the reported temperature from the extended command 0x7D.
4. Calculate temperature offset:
 $TS4\ offset = TEMP_{TS4} - TS4 + TS4\ offset_{old}$
5. Update the data flash with the calculated value.
6. Re-check the current reading. Repeat the steps if the readings are not accurate.

2.7.10 TS4 Calibration (Option 2)

1. Apply a known temperature in 0.1°C
 - Make sure temperature $Temp_{TS4}$ is applied to the thermistor connected to the TS4 pin.

2. Read **Coeff a1, Coeff a2, Coeff a3, Coeff a4, Coeff b1, Coeff b2, Coeff b3, Coeff b4** from data flash based on TS4 configuration to cell or FET temperature.
3. Poll *ManufacturerData()* until ZZ increments by 2 before reading data.
4. Grab ADC conversion readings of temperature from *ManufacturerData()*:
 - $ADC_{TS4} = \text{JJjj of } ManufacturerData(), \text{ is } ADC_{TS4} < 0x8000? \text{ If yes use } ADC_{TS4}, \text{ otherwise } ADC_{TS4} = \text{JJjj} - 0xFFFF - 0x0001$
5. To average several readings for higher accuracy, poll *ManufacturerData()* until ZZ increments that indicates updates values.
 - $ADC_{TS4} = [ADC_{TS4}(\text{reading } n) + \dots + ADC_{TS4}(\text{reading } 1)]/n$
6. Calculate temperature offset:

$$A = \frac{ADC_{TS4}}{2^{15}}$$

$$B = \frac{A}{(CoeffA1)*A^4 + (CoeffA2)*A^3 + (CoeffA3)*A^2 + (CoeffA4)*A + (CoeffA5)} * 2^{14}$$

$$T_{TS4} = ((Coeff B1) * B^3 + (Coeff B2) * B^2 + (Coeff B3) * B^1 + (Coeff B4)) * 0.1 - 273.15$$

$$External\ 4\ Temperature\ Offset = TEMP_{TS4} - T_{TS4}$$

7. Update the data flash with calculated with **External 4 Temperature Offset**.
8. Re-check the temperature reading. Repeat the steps if the readings are not accurate.

Protections

3.1 Introduction

All of the protection items can be enabled or disabled under Settings/Enabled Protections 0–15 and Settings/Enabled Protections 16–31.

3.2 Cell Undervoltage Protection

The device can detect undervoltage in batteries and protect cells from damage by preventing further discharge.

Status	Condition	Action
Normal	All Cell voltages in $Voltages() > \text{Threshold}$	<ul style="list-style-type: none"> • $SafetyAlert()[CUV] = 0$ • $BatteryStatus()[TDA] = 0$
Alert	Any Cell voltages in $Voltages() \leq \text{Threshold}$	<ul style="list-style-type: none"> • $SafetyAlert()[CUV] = 1$ • If not charging, $BatteryStatus()[TDA] = 1$.
Trip	Any Cell voltages in $Voltages()$ continuous $\leq \text{Threshold}$ for Delay duration	<ul style="list-style-type: none"> • $SafetyAlert()[CUV] = 0$ • $SafetyStatus()[CUV] = 1$ • $BatteryStatus()[FD] = 1$ • Discharging is not allowed.
Recovery	$SafetyStatus()[CUV] = 1$ AND All Cell voltages in $Voltages() > \text{Recovery}$ AND (CUV_RECOV_CHG = 0 OR (CUV_RECOV_CHG = 1 AND Charging Detected))	<ul style="list-style-type: none"> • $SafetyStatus()[CUV] = 0$ • $BatteryStatus()[FD] = 0$ • Discharging is allowed.

3.3 Cell Undervoltage Compensated Protection

The device can detect undervoltage in batteries and protect cells from damage by preventing further discharge. The protection is compensated by the $Current() \times CellResistance4..1$.

Status	Condition	Action
Normal	All Cell voltages in $Voltages() - Current() \times Cell Resistance > \text{Threshold}$	<ul style="list-style-type: none"> • $SafetyAlert()[CUVC] = 0$ • $BatteryStatus()[TDA] = 0$
Alert	Any Cell voltages in $Voltages() - Current() \times Cell Resistance \leq \text{Threshold}$	<ul style="list-style-type: none"> • $SafetyAlert()[CUVC] = 1$ • If not charging, $BatteryStatus()[TDA] = 1$.
Trip	Any Cell voltages in $Voltages() - Current() \times Cell Resistance$ continuous $\leq \text{Threshold}$ for Delay duration	<ul style="list-style-type: none"> • $SafetyAlert()[CUVC] = 0$ • $SafetyStatus()[CUVC] = 1$ • $BatteryStatus()[FD] = 1$ • $BatteryStatus()[TDA] = 0$ • Discharging is not allowed.
Recovery	$SafetyStatus()[CUVC] = 1$ AND All Cell voltages in $Voltages() > \text{Recovery}$ AND (CUV_RECOV_CHG = 0 OR (CUV_RECOV_CHG = 1 AND Charging Detected))	<ul style="list-style-type: none"> • $SafetyStatus()[CUVC] = 0$ • $BatteryStatus()[FD] = 0$ • Discharging is allowed.

3.4 Cell Overvoltage Protection

The device can detect cell overvoltage in batteries and protect cells from damage by preventing further charging.

Status	Condition	Action
Normal	$Temperature() \leq T2$ AND all Cell voltages in $Voltages() < \text{Threshold Low Temp}$	$SafetyAlert()[COV] = 0$
Normal	$T2 < Temperature() \leq T3$ AND all Cell voltages in $Voltages() < \text{Threshold Standard Temp}$	$SafetyAlert()[COV] = 0$
Normal	$T3 < Temperature()$ AND all Cell voltages in $Voltages() < \text{Threshold High Temp}$	$SafetyAlert()[COV] = 0$
Normal	$T5 < Temperature() \leq T6$ AND all Cell voltages in $Voltages() < \text{Threshold Rec Temp}$	$SafetyAlert()[COV] = 0$
Alert	$Temperature() \leq T2$ AND any Cell voltages in $Voltages() \geq \text{Threshold Low Temp}$	$SafetyAlert()[COV] = 1$
Alert	$T2 < Temperature() \leq T3$ AND any Cell voltages in $Voltages() \geq \text{Threshold Standard Temp}$	$SafetyAlert()[COV] = 1$
Alert	$T3 < Temperature()$ AND any Cell voltages in $Voltages() \geq \text{Threshold High Temp}$	$SafetyAlert()[COV] = 1$
Alert	$T5 < Temperature() \leq T6$ AND any Cell voltages in $Voltages() \geq \text{Threshold Rec Temp}$	$SafetyAlert()[COV] = 1$
Trip	$Temperature() \leq T2$ AND any Cell voltages in $Voltages()$ continuous $\geq \text{Threshold Low Temp}$ for Delay duration	<ul style="list-style-type: none"> • $SafetyAlert()[COV] = 0$ • $SafetyStatus()[COV] = 1$ • If charging, $BatteryStatus()[TCA] = 1$ • If charging, $BatteryStatus()[OCA] = 1$ • Charging is not allowed.
Trip	$T2 < Temperature() \leq T3$ AND any Cell voltages in $Voltages()$ continuous $\geq \text{Threshold Standard Temp}$ for Delay duration	<ul style="list-style-type: none"> • $SafetyAlert()[COV] = 0$ • $SafetyStatus()[COV] = 1$ • If charging, $BatteryStatus()[TCA] = 1$ • If charging, $BatteryStatus()[OCA] = 1$ • Charging is not allowed.
Trip	$T3 < Temperature()$ AND any Cell voltages in $Voltages()$ continuous $\geq \text{Threshold High Temp}$ for Delay duration	<ul style="list-style-type: none"> • $SafetyAlert()[COV] = 0$ • $SafetyAlert()[COV] = 1$ • If charging, $BatteryStatus()[TCA] = 1$ • If charging, $BatteryStatus()[OCA] = 1$ • Charging is not allowed.
Trip	$T5 < Temperature() \leq T6$ AND any Cell voltages in $Voltages()$ continuous $\geq \text{Threshold Rec Temp}$ for Delay duration	<ul style="list-style-type: none"> • $SafetyAlert()[COV] = 0$ • $SafetyAlert()[COV] = 1$ • If charging, $BatteryStatus()[TCA] = 1$ • If charging, $BatteryStatus()[OCA] = 1$ • Charging is not allowed.
Recovery	$SafetyAlert()[COV] = 1$ AND $Temperature() \leq T2$ AND all Cell voltages in $Voltages() < \text{Recovery Low Temp}$	<ul style="list-style-type: none"> • $SafetyAlert()[COV] = 0$ • $BatteryStatus()[TCA] = 0$ • $BatteryStatus()[OCA] = 0$ • Charging is allowed.
Recovery	$SafetyAlert()[COV] = 1$ AND $T2 < Temperature() \leq T3$ AND all Cell voltages in $Voltages() < \text{Recovery Standard Temp}$	<ul style="list-style-type: none"> • $SafetyStatus()[COV] = 0$ • $BatteryStatus()[TCA] = 0$ • $BatteryStatus()[OCA] = 0$ • Charging is allowed.
Recovery	$SafetyStatus()[COV] = 1$ AND $T3 < Temperature()$ AND all Cell voltages in $Voltages() < \text{Recovery High Temp}$	<ul style="list-style-type: none"> • $SafetyStatus()[COV] = 0$ • $BatteryStatus()[TCA] = 0$ • $BatteryStatus()[OCA] = 0$ • Charging is allowed.

Status	Condition	Action
Recovery	$SafetyStatus()[COV] = 1$ AND $T5 < Temperature() \leq T6$ AND all Cell voltages in $Voltages() < Recovery$ Rec Temp	<ul style="list-style-type: none"> $SafetyStatus()[COV] = 0$ $BatteryStatus()[TCA] = 0$ $BatteryStatus()[OCA] = 0$ Charging is allowed.

3.5 Overcurrent in Charge Protection

The device has two independent overcurrent in charge protections that can be set to different current and delay thresholds to accommodate different charging behaviors.

Status	Condition	Action
Normal	$Current() < OCC1:Threshold$	$SafetyAlert()[OCC1] = 0$
Normal	$Current() < OCC2:Threshold$	$SafetyAlert()[OCC2] = 0$
Alert	$Current() \geq OCC1:Threshold$	$SafetyAlert()[OCC1] = 1$
Alert	$Current() \geq OCC2:Threshold$	$SafetyAlert()[OCC2] = 1$
Trip	$Current()$ continuous $\geq OCC1:Threshold$ for $OCC1:Delay$ duration	<ul style="list-style-type: none"> $SafetyAlert()[OCC1] = 0$ $SafetyStatus()[OCC1] = 1$ If charging, $BatteryStatus()[TCA] = 1$ Charging is not allowed. Start recovery delay timer
Trip	$Current()$ continuous $\geq OCC2:Threshold$ for $OCC2:Delay$ duration	<ul style="list-style-type: none"> $SafetyAlert()[OCC2] = 0$ $SafetyStatus()[OCC2] = 1$ If charging, $BatteryStatus()[TCA] = 1$ Charging is not allowed. Start recovery delay timer
Recovery	$[SafetyStatus()[OCC1] = 1$ OR $SafetyStatus()[OCC2] = 1]$ AND $Current() < OCC:Recovery$ Threshold AND recovery delay timer running $> OCC:Recovery$ Delay Time	<ul style="list-style-type: none"> $SafetyStatus()[OCC1] = 0$ $SafetyStatus()[OCC2] = 0$ $BatteryStatus()[TCA] = 0$ Charging is allowed.

3.6 Overcurrent in Discharge Protection

The device has two independent overcurrent in discharge protections that can be set to different current and delay thresholds to accommodate different load behaviors.

Status	Condition	Action
Normal	$Current() > OCD1:Threshold$	$SafetyAlert()[OCD1] = 0$
Normal	$Current() > OCD2:Threshold$	$SafetyAlert()[OCD2] = 0$
Alert	$Current() \leq OCD1:Threshold$	$SafetyAlert()[OCD1] = 1$
Alert	$Current() \leq OCD2:Threshold$	$SafetyAlert()[OCD2] = 1$
Trip	$Current()$ continuous $\leq OCD1:Threshold$ for $OCD1:Delay$ duration	<ul style="list-style-type: none"> $SafetyAlert()[OCD1] = 0$ $SafetyStatus()[OCD1] = 1$ Discharging is not allowed. Start recovery delay timer
Trip	$Current()$ continuous $\leq OCD2:Threshold$ for $OCD2:Delay$ duration	<ul style="list-style-type: none"> $SafetyAlert()[OCD2] = 0$ $SafetyStatus()[OCD2] = 1$ Discharging is not allowed. Start recovery delay timer
Recovery	$[SafetyStatus()[OCD1] = 1$ OR $SafetyStatus()[OCD2] = 1]$ AND $Current() > OCD:Recovery$ Threshold and recovery delay timer running $> OCD:Recovery$ Delay Time	<ul style="list-style-type: none"> $SafetyStatus()[OCD1] = 0$ $SafetyStatus()[OCD2] = 0$ Discharging is allowed.

3.7 Hardware-Based Protection

The device has three main hardware-based protections—OLD, SCC, and SCD—with adjustable current and delay time. The data flash protection Threshold and Delay settings are documented in [Appendix A](#). By setting the [RSNS] bit under Settings:AFE State Control provide an option to divide the Threshold value into half. The Threshold settings are in mV, hence, the actual current that will trigger the protection is based on the RSNS resistor used in the schematic design.

All the hardware-based protections provides a short term Trip/Alert/Recovery protection to account for a current spike as well as a Trip/Alert/Latch protection for true faulty condition. The latch feature also stops the FETs from toggling on and off continuously, preventing damage to the FETs.

In general, when a fault is Detected after the Delay time, both CHG and DSG FETs will be disabled (Trip stage). An internal fault counter will be incremented (Alert stage). Since both FETs are off, the current will drop to 0 mA, after Recovery time, the CHG and DSG FETs will be turned on again (Recovery stage).

If the alert is caused by a current spike, the fault count will be decremented after Counter Dec Delay time. If this is a true faulty condition, the device will enter the Trip stage after Delay time, and repeat the Trip/Alert/Recovery cycle. The internal fault counter is incremented every time the device goes through the Trip/Alert/Recovery cycle. Once the internal fault counter hits the Latch Limit, the protection enters a Latch stage and the fault will only be cleared through the Latch Reset condition.

The Trip/Alert/Recovery/Latch stages are documented in each hardware-based protection sections below.

3.7.1 Overload in Discharge Protection

The device has a hardware-based overload in discharge protection with adjustable current and delay.

Status	Condition	Action
Normal	$Current() > (Threshold/RSNS)$	$SafetyAlert()[OLD] = 0$, if OLD counter = 0
Trip	$Current()$ continuous $\leq (Threshold/RSNS)$ for Delay duration	<ul style="list-style-type: none"> $SafetyStatus()[OLD] = 1$ CHG FET and DSG FET disabled Increment OLD counter
Alert	OLD counter > 0	<ul style="list-style-type: none"> $SafetyAlert()[OLD] = 1$ Decrement OLD counter by one after each Counter Dec Delay period
Recovery	$SafetyStatus()[OLD] = 1$ AND $SafetyStatus()[OLDL] = 0$ AND Recovery duration wait time	<ul style="list-style-type: none"> $SafetyStatus()[OLD] = 0$ CHG FET and DSG FET return to normal
Latch	OLD counter \geq Latch Limit	<ul style="list-style-type: none"> $SafetyStatus()[OLD] = 0$ $SafetyStatus()[OLDL] = 1$ Reset OLD counter Disable recovery method Enable reset method
Latch Reset (NR = 0)	$SafetyStatus()[OLDL] = 1$ AND System Configuration[NR] = 0 AND Low-high-low transition on PRES pin	<ul style="list-style-type: none"> $SafetyStatus()[OLDL] = 0$ CHG FET and DSG FET return to normal Disable reset method Enable recovery method
Latch Reset (NR = 1)	$SafetyStatus()[OLDL] = 1$ AND System Configuration[NR] = 1 AND Reset duration wait time	<ul style="list-style-type: none"> $SafetyStatus()[OLDL] = 0$ CHG FET and DSG FET return to normal Disable reset method Enable recovery method

3.7.2 Short Circuit in Charge Protection

The device has a hardware-based short circuit in charge protection with adjustable current and delay.

Status	Condition	Action
Normal	$Current() < (Threshold[2:0]/RSNS)$	$SafetyAlert()[SCC] = 0$, if SCC counter = 0
Trip	$Current()$ continuous $\geq (Threshold[2:0]/RSNS)$ for Threshold[7:4] duration	<ul style="list-style-type: none"> $SafetyStatus()[SCC] = 1$ If charging, $BatteryStatus()[TCA] = 1$ CHG FET and DSG FET disabled Increment SCC counter
Alert	SCC counter > 0	<ul style="list-style-type: none"> $SafetyAlert()[SCC] = 1$ Decrement SCC counter by one after each Counter Dec Delay period
Recovery	$SafetyStatus()[SCC] = 1$ AND $SafetyStatus()[SCCL] = 0$ AND Recovery duration wait time	<ul style="list-style-type: none"> $SafetyStatus()[SCC] = 0$ $BatteryStatus()[TCA] = 0$ CHG FET and DSG FET return to normal
Latch	SCC counter \geq Latch Limit	<ul style="list-style-type: none"> $SafetyStatus()[SCC] = 0$ $SafetyStatus()[SCCL] = 1$ Reset SCC counter Disable recovery method Enable reset method
Latch Reset (NR = 0)	$SafetyStatus()[SCCL] = 1$ AND System Configuration[NR] = 0 AND Low-high-low transition on PRES pin	<ul style="list-style-type: none"> $SafetyStatus()[SCCL] = 0$ $BatteryStatus()[TCA] = 0$ CHG FET and DSG FET return to normal Disable reset method Enable recovery method
Latch Reset (NR = 1)	$SafetyStatus()[SCCL] = 1$ AND System Configuration[NR] = 1 AND Reset duration wait time	<ul style="list-style-type: none"> $SafetyStatus()[SCCL] = 0$ $BatteryStatus()[TCA] = 0$ CHG FET and DSG FET return to normal Disable reset method Enable recovery method

3.7.3 Short Circuit in Discharge Protection

The device has a hardware-based short circuit in discharge protection with adjustable current and delay.

Status	Condition	Action
Normal	$Current() > (Threshold[2:0]/RSNS)$	$SafetyAlert()[SCD] = 0$, if SCD counter = 0
Trip	$Current()$ continuous $\leq (Threshold[2:0]/RSNS)$ for Threshold[7:4] duration	<ul style="list-style-type: none"> $SafetyStatus()[SCD] = 1$ CHG FET and DSG FET disabled Increment SCD counter
Alert	SCD counter > 0	<ul style="list-style-type: none"> $SafetyAlert()[SCD] = 1$ Decrement SCD counter by one after each Counter Dec Delay period
Recovery	$SafetyStatus()[SCD] = 1$ AND $SafetyStatus()[SCDL] = 0$ AND Recovery duration wait time	<ul style="list-style-type: none"> $SafetyStatus()[SCD] = 0$ CHG FET and DSG FET return to normal
Latch	SCD counter \geq Latch limit	<ul style="list-style-type: none"> $SafetyStatus()[SCD] = 0$ $SafetyStatus()[SCDL] = 1$ Reset SCD counter Disable recovery method Enable reset method

Status	Condition	Action
Latch Reset (NR = 0)	$SafetyStatus()[SCDL] = 1$ AND System Configuration[NR] = 0 AND Low-high-low transition on PRES pin	<ul style="list-style-type: none"> • $SafetyStatus()[SCDL] = 0$ • CHG FET and DSG FET return to normal • Disable reset method • Enable recovery method
Latch Reset (NR = 1)	$SafetyStatus()[SCCL] = 1$ AND System Configuration[NR] = 1 AND Reset duration wait time	<ul style="list-style-type: none"> • $SafetyStatus()[SCDL] = 0$ • CHG FET and DSG FET return to normal • Disable reset method • Enable recovery method

3.8 Overtemperature in Charge Protection

The device has an overtemperature protection for cells in charge direction.

Status	Condition	Action
Normal	Cell Temperature in $Temperatures() < \text{Threshold}$ AND charging	$SafetyAlert()[OTC] = 0$
Alert	Cell Temperature in $Temperatures() \geq \text{Threshold}$ AND charging	$SafetyAlert()[OTC] = 1$
Trip	Cell Temperature in $Temperatures() \geq \text{Threshold}$ AND charging for Delay duration	<ul style="list-style-type: none"> • $SafetyAlert()[OTC] = 0$ • $SafetyStatus()[OTC] = 1$ • $BatteryStatus()[OTA] = 1$ • If charging, $BatteryStatus()[TCA] = 1$ • Charging Disabled if Temperature Configuration[OTFET] = 1
Recovery	$SafetyStatus()[OTC]$ AND Cell Temperature in $Temperatures() < \text{Recovery}$	<ul style="list-style-type: none"> • $SafetyStatus()[OTC] = 0$ • $BatteryStatus()[OTA] = 0$ • $BatteryStatus()[TCA] = 0$ • Charging is allowed if Temperature Configuration[OTFET] = 1.

3.9 Overtemperature in Discharge Protection

The device has an overtemperature protection for cells in discharge direction.

Status	Condition	Action
Normal	Cell Temperature in $Temperatures() < \text{Threshold}$ AND discharging	$SafetyAlert()[OTD] = 0$
Alert	Cell Temperature in $Temperatures() \geq \text{Threshold}$ AND discharging	$SafetyAlert()[OTD] = 1$
Trip	Cell Temperature in $Temperatures() \geq \text{Threshold}$ AND discharging for Delay duration	<ul style="list-style-type: none"> • $SafetyAlert()[OTD] = 0$ • $SafetyStatus()[OTD] = 1$ • $BatteryStatus()[OTA] = 1$ • Discharging Disabled if Temperature Configuration[OTFET] = 1
Recovery	$SafetyStatus()[OTD]$ AND Cell Temperature in $Temperatures() < \text{Recovery}$	<ul style="list-style-type: none"> • $SafetyStatus()[OTD] = 0$ • $BatteryStatus()[OTA] = 0$ • Discharging is allowed if Temperature Configuration[OTFET] = 1.

3.10 Overtemperature FET Protection

The device has an overtemperature protection to limit the FET temperature.

Status	Condition	Action
Normal	FET Temperature in <i>Temperatures()</i> < Threshold	<i>SafetyAlert()[OTF]</i> = 0
Alert	FET Temperature in <i>Temperatures()</i> ≥ Threshold	<i>SafetyAlert()[OTF]</i> = 1
Trip	FET Temperature in <i>Temperatures()</i> ≥ Threshold for Delay duration	<ul style="list-style-type: none"> • <i>SafetyAlert()[OTF]</i> = 0 • <i>SafetyStatus()[OTF]</i> = 1 • <i>BatteryStatus()[OTA]</i> = 1 • CHG FET and DSG FET off if Temperature Configuration[OTFET] = 1
Recovery	<i>SafetyStatus()[OTF]</i> AND FET Temperature in <i>Temperatures()</i> < Recovery	<ul style="list-style-type: none"> • <i>SafetyStatus()[OTD]</i> = 0 • <i>BatteryStatus()[OTA]</i> = 0 • CHG FET and DSG FET return to normal

3.11 SBS Host Watchdog Protection

The device can check for periodic communication over SBS and prevent usage of the battery pack if no valid communication is Detected.

Status	Condition	Action
Trip	No valid SBS transaction for Delay duration	<ul style="list-style-type: none"> • <i>SafetyStatus()[HWD]</i> = 1 • Charging disabled, CHG FET off
Recovery	Valid SBS transaction Detected	<ul style="list-style-type: none"> • <i>SafetyStatus()[HWD]</i> = 0 • CHG FET returns to normal, charging is allowed.

3.12 Pre-Charge Timeout Protection

The device can measure the pre-charge time and stop charging if it exceeds the adjustable period.

Status	Condition	Action
Enable	<i>Current()</i> > Charge Threshold AND <i>ChargingStatus()[PV]</i> = 1	<ul style="list-style-type: none"> • Start PTO timer • <i>SafetyAlert()[PTO]</i> = 1 • <i>SafetyAlert()[PTOS]</i> = 0
Suspend or Recovery	<i>Current()</i> < Suspend Threshold	<ul style="list-style-type: none"> • Stop PTO timer • <i>SafetyAlert()[PTO]</i> = 1 • <i>SafetyAlert()[PTOS]</i> = 1
Trip	PTO time > Delay	<ul style="list-style-type: none"> • Stop PTO timer • <i>SafetyAlert()[PTO]</i> = 0 • <i>SafetyStatus()[PTO]</i> = 1 • If charging, <i>BatteryStatus()[TCA]</i> = 1 • Charging is not allowed.
Reset	<i>SafetyStatus()[PTO]</i> = 1 AND System Configuration[NR] = 0 AND (Discharge by an amount of Reset OR low-high-low transition on PRES)	<ul style="list-style-type: none"> • Stop and reset PTO timer • <i>SafetyAlert()[PTO]</i> = 0 • <i>SafetyAlert()[PTOS]</i> = 0 • <i>SafetyStatus()[PTO]</i> = 0 • <i>BatteryStatus()[TCA]</i> = 0 • Charging is allowed.
Reset	<i>SafetyStatus()[PTO]</i> = 1 AND System Configuration[NR] = 1 AND (Discharge by an amount of Reset)	<ul style="list-style-type: none"> • Stop and reset PTO timer • <i>SafetyAlert()[PTO]</i> = 0 • <i>SafetyAlert()[PTOS]</i> = 0 • <i>SafetyStatus()[PTO]</i> = 0 • <i>BatteryStatus()[TCA]</i> = 0 • Charging is allowed.

3.13 Fast Charge Timeout Protection

The device can measure the charge time and stop charging if it exceeds the adjustable period.

Status	Condition	Action
Enable	$Current() > \text{Charge Threshold}$ AND ($ChargingStatus()[LV] = 1$ OR $ChargingStatus()[MV] = 1$ OR $ChargingStatus()[HV] = 1$)	<ul style="list-style-type: none"> Start CTO timer $SafetyAlert()[CTO] = 1$ $SafetyAlert()[CTOS] = 0$
Suspend or Recovery	$Current() < \text{Suspend Threshold}$	<ul style="list-style-type: none"> Stop CTO timer $SafetyAlert()[CTO] = 1$ $SafetyAlert()[CTOS] = 1$
Trip	CTO time $> \text{Delay}$	<ul style="list-style-type: none"> Stop CTO timer $SafetyAlert()[CTO] = 0$ $SafetyStatus()[CTO] = 1$ If charging, $BatteryStatus()[TCA] = 1$ Charging is not allowed.
Reset	$SafetyStatus()[CTO] = 1$ AND System Configuration[NR] = 0 AND (Discharge by an amount of Reset OR low-high-low transition on PRES)	<ul style="list-style-type: none"> Stop and reset CTO timer $SafetyAlert()[CTO] = 0$ $SafetyAlert()[CTOS] = 0$ $SafetyStatus()[CTO] = 0$ $BatteryStatus()[TCA] = 0$ Charging is allowed.
Reset	$SafetyStatus()[CTO] = 1$ AND System Configuration[NR] = 1 AND (Discharge by an amount of Reset)	<ul style="list-style-type: none"> Stop and reset CTO timer $SafetyAlert()[CTO] = 0$ $SafetyAlert()[CTOS] = 0$ $SafetyStatus()[CTO] = 0$ $BatteryStatus()[TCA] = 0$ Charging is allowed.

3.14 Overcharge Protection

The device can prevent continuing charging if the pack is charged in excess over $FullChargeCapacity()$.

Status	Condition	Action
Normal	$RemainingCapacity() < FullChargeCapacity()$	$SafetyAlert()[OC] = 0$
Alert	$RemainingCapacity() \geq FullChargeCapacity()$	$SafetyAlert()[OC] = 1$
Trip	$RemainingCapacity() \geq FullChargeCapacity() + \text{Threshold}$	<ul style="list-style-type: none"> $SafetyAlert()[OC] = 0$ $SafetyStatus()[OC] = 1$ If charging, $BatteryStatus()[TCA] = 1$ Charging is not allowed.
Recovery	$SafetyStatus()[OC] = 1$ System Configuration[NR] = 0 AND (Low-high-low transition on PRES pin)	<ul style="list-style-type: none"> $SafetyStatus()[OC] = 0$ $BatteryStatus()[TCA] = 0$ Charging is allowed.
Recovery	$SafetyStatus()[OC] = 1$ System Configuration[NR] = 1 AND continuous discharge of Recovery OR $RemainingStateOfCharge() < \text{RSOC Recovery}$	<ul style="list-style-type: none"> $SafetyStatus()[OC] = 0$ $BatteryStatus()[TCA] = 0$ Charging is allowed.

3.15 Over-ChargingVoltage() Protection

The device can stop charging if it measures a difference between the requested $ChargingVoltage()$ and the delivered voltage from the charger.

Status	Condition	Action
Normal	$Voltage() < ChargingVoltage() + CHGV:Threshold$	$SafetyAlert()[CHGV] = 0$
Alert	$Voltage() \geq ChargingVoltage() + CHGV:Threshold$	$SafetyAlert()[CHGV] = 1$
Trip	$Voltage() \text{ continuous} \geq ChargingVoltage() + CHGV:Threshold$ for CHGV:Delay period	<ul style="list-style-type: none"> • $SafetyAlert()[CHGV] = 0$ • $SafetyStatus()[CHGV] = 1$ • If charging, $BatteryStatus()[TCA] = 1$ • Charging is not allowed.
Recovery	$SafetyStatus()[CHGV] = 1$ AND $Voltage() \leq ChargingVoltage() + CHGV \text{ Recovery}$	<ul style="list-style-type: none"> • $SafetyStatus()[CHGV] = 0$ • $BatteryStatus()[TCA] = 0$ • Charging is allowed.

3.16 Over-ChargingCurrent() Protection

The device can stop charging if it measures a difference between the requested *ChargingCurrent()* and the delivered current from the charger.

Status	Condition	Action
Normal	$Current() < ChargingCurrent() + CHGC:Threshold$	$SafetyAlert()[CHGC] = 0$
Alert	$Current() \geq ChargingCurrent() + CHGC:Threshold$	$SafetyAlert()[CHGC] = 1$
Trip	$Current() \text{ continuous} \geq ChargingCurrent() + CHGC:Threshold$ for CHGC:Delay period	<ul style="list-style-type: none"> • $SafetyAlert()[CHGC] = 0$ • $SafetyStatus()[CHGC] = 1$ • If charging, $BatteryStatus()[TCA] = 1$ • Charging is not allowed.
Recovery	$SafetyStatus()[CHGC] = 1$ AND $Current() \leq ChargingCurrent() + CHGC \text{ Recovery}$	<ul style="list-style-type: none"> • $SafetyStatus()[CHGC] = 0$ • $BatteryStatus()[TCA] = 0$ • Charging is allowed.

Advanced Charge Algorithm

4.1 Introduction

The device can change value of *ChargingVoltage()* and *ChargingCurrent()* based on *Temperature()* and *Cell Voltage1..4()*. Its flexible charging algorithm is JEITA compatible and can also meet ATL cell charge requirements. The *ChargingStatus()* register shows the state of the charging algorithm.

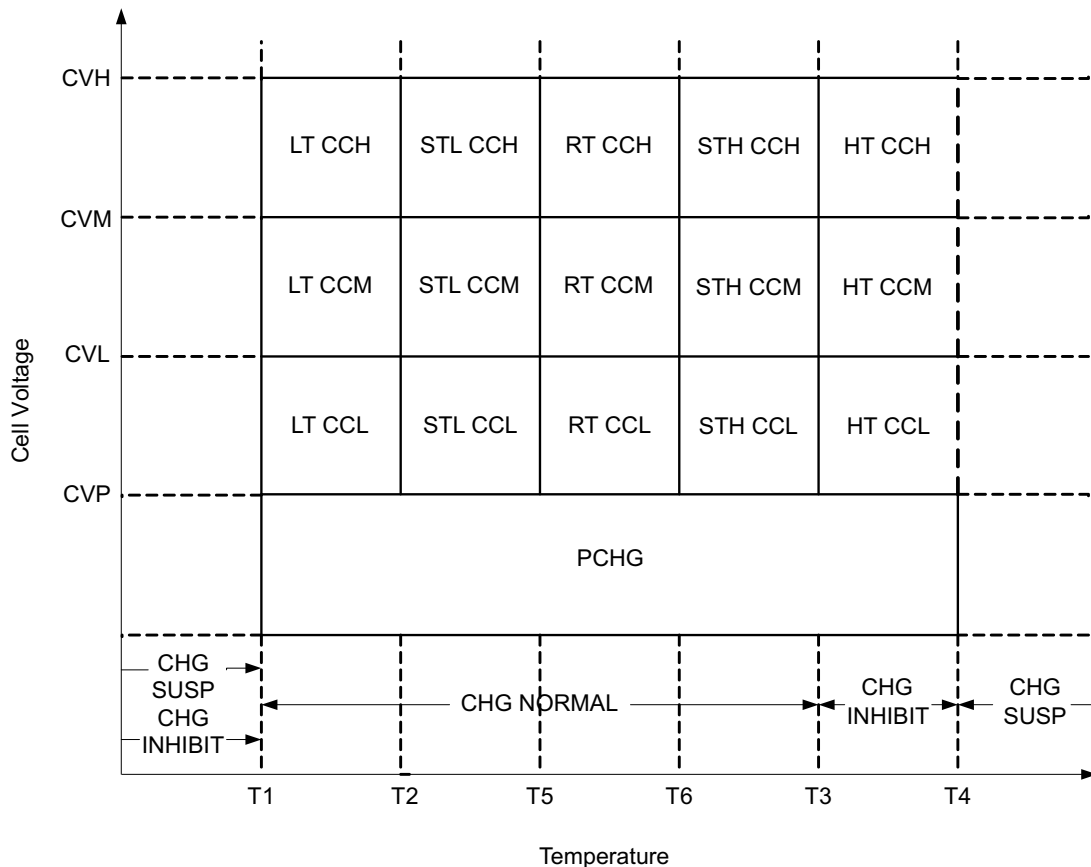

4.2 Charge Temperature Ranges

The measured temperature is segmented into several temperature ranges. The charging algorithm adjusts *ChargingCurrent()* and *ChargingVoltage()* according to the temperature range. The temperature range need to be set to following:

$$T1 \leq T2 \leq T5 \leq T6 \leq T3 \leq T4$$

Status	Condition	Action
Under Temp	$Temperature() < T1$	$ChargingStatus()[UT] = 1$
Low Temp	$T1 < Temperature() < T2$	$ChargingStatus()[LT] = 1$
Standard Temp Low	$T2 < Temperature() < T5$	$ChargingStatus()[STL] = 1$
Recommended	$T5 < Temperature() < T6$	$ChargingStatus()[RT] = 1$

Status	Condition	Action
Standard Temp High	$T6 < \text{Temperature}() < T3$	$\text{ChargingStatus}()[\text{STH}] = 1$
High Temp	$T3 < \text{Temperature}() < T4$	$\text{ChargingStatus}()[\text{HT}] = 1$
Over Temp	$T4 < \text{Temperature}()$	$\text{ChargingStatus}()[\text{OT}] = 1$

4.3 Voltage Range

The measured cell voltage is segmented into several voltage ranges. The charging algorithm adjusts $\text{ChargingCurrent}()$ according to the temperature range and voltage range. The voltage range need to be set to following:

$$\text{ChargingVoltage Low} \leq \text{ChargingVoltage Med} \leq \text{ChargingVoltageHigh} \leq \times \text{Temp Charging:Voltage}$$

Status	Condition	Action
Pre-Charge	Any Cell Voltages in $\text{Voltages}() < \text{Charging Voltage Low}$	$\text{ChargingStatus}()[\text{PV}] = 1$
Low	Charging Voltage Low $<$ all Cell Voltages in $\text{Voltages}()$ OR any Cell Voltages in $\text{Voltages}() < \text{Charging Voltage Med}$	$\text{ChargingStatus}()[\text{LV}] = 1$
Medium	Charging Voltage Med $<$ all Cell Voltages in $\text{Voltages}()$ OR any Cell Voltages in $\text{Voltages}() < \text{Charging Voltage High}$	$\text{ChargingStatus}()[\text{MV}] = 1$
High	Charging Voltage High $<$ all Cell Voltages in $\text{Voltages}()$	$\text{ChargingStatus}()[\text{HV}] = 1$

A voltage hysteresis setting is available, and is applied when the voltage decreases.

4.4 Charging Current

The $\text{ChargingCurrent}()$ value will change depending on charge algorithm.

ChargingStatus()										Action
UT	LT	STL/STH	HT	RT	OT	PV	LV	MV	HV	
1	0	0	0	0	0	x	x	x	x	$\text{ChargingCurrent}() = 0$
0	x	x	x	x	0	1	0	0	0	$\text{ChargingCurrent}() = \text{PCHG:Current}$
0	1	0	0	0	0	0	1	0	0	$\text{ChargingCurrent}() = \text{Low Temp Charging:Current Low}$
0	1	0	0	0	0	0	0	1	0	$\text{ChargingCurrent}() = \text{Low Temp Charging:Current Med}$
0	1	0	0	0	0	0	0	0	1	$\text{ChargingCurrent}() = \text{Low Temp Charging:Current High}$
0	0	1	0	0	0	0	1	0	0	$\text{ChargingCurrent}() = \text{Standard Temp Charging:Current Low}$
0	0	1	0	0	0	0	0	1	0	$\text{ChargingCurrent}() = \text{Standard Temp Charging:Current Med}$
0	0	1	0	0	0	0	0	0	1	$\text{ChargingCurrent}() = \text{Standard Temp Charging:Current High}$
0	0	0	1	0	0	0	1	0	0	$\text{ChargingCurrent}() = \text{High Temp Charging:Current Low}$
0	0	0	1	0	0	0	0	1	0	$\text{ChargingCurrent}() = \text{High Temp Charging:Current Med}$
0	0	0	1	0	0	0	0	0	1	$\text{ChargingCurrent}() = \text{High Temp Charging:Current High}$
0	0	0	0	1	0	0	1	0	0	$\text{ChargingCurrent}() = \text{Rec Temp Charging:Current Low}$
0	0	0	0	1	0	0	0	1	0	$\text{ChargingCurrent}() = \text{Rec Temp Charging:Current Med}$

ChargingStatus()										Action
UT	LT	STL/STH	HT	RT	OT	PV	LV	MV	HV	
0	0	0	0	1	0	0	0	0	1	ChargingCurrent() = Rec Temp Charging:Current High
0	0	0	0	0	1	x	x	x	x	ChargingCurrent() = 0

4.5 Charging Voltage

The *ChargingVoltage()* will change depending on the charge algorithm.

ChargingStatus()						Action
UT	LT	STL/STH	HT	RT	OT	
1	0	0	0	0	0	ChargingVoltage() = 0
0	1	0	0	0	0	ChargingVoltage() = Low Temp Charging:Voltage × Number of cells
0	0	1	0	0	0	ChargingVoltage() = Standard Temp Charging:Voltage × Number of cells
0	0	0	1	0	0	ChargingVoltage() = High Temp Charging:Voltage × Number of cells
0	0	0	0	1	0	ChargingVoltage() = Rec Temp Charging:Voltage × Number of cells
0	0	0	0	0	1	ChargingCurrent() = 0

A temperature hysteresis setting is available, and is applied when temperature decreases.

4.6 Valid Charge Termination

The charge termination condition has to be met to enable valid charge termination.

Status	Condition	Action
Charging	<i>GaugingStatus()[REST]</i> = 0 AND <i>GaugingStatus()[DSG]</i> = 0	Charge Algorithm active
Valid Charge Termination	(Charging AND <i>AverageCurrent()</i> continuous < Charge Term Taper Current AND <i>Voltage()</i> > <i>ChargingVoltage()/Number of Cells</i> + Charge Term Voltage AND Δcharge > Taper Charge) for two consecutive 40-s periods	<ul style="list-style-type: none"> • <i>ChargingStatus()[VCT]</i> sets • If SBS Configuration[FCSETVCT], <i>BatteryStatus[FC]</i> = 1 • If SBS Configuration[TCASETVCT], <i>BatteryStatus[TCA]</i> = 1 • If <i>BatteryStatus[TCA]</i>, <i>ChargingStatus[MCHG]</i> = 1 • If <i>ChargingStatus[MCHG]</i>: <ul style="list-style-type: none"> – If Charging <i>Configuration[CHGFET]</i> = 1, CHG and PCHG FET off AND <i>ChargingCurrent()</i> = 0 – If Charging <i>Configuration[CHGFET]</i> = 0, CHG FET active and <i>ChargingCurrent()</i> = MaintenanceCurrent

4.7 Charge Inhibit

The device can prevent start of charging at high and low temperatures to prevent damage of the cells.

Status	Condition	Action
Normal	$T1 < Temperature() < T3$	<ul style="list-style-type: none"> • <i>ChargingStatus()[IN]</i> = 0 • <i>ChargingVoltage()</i> = charging algorithm • <i>ChargingCurrent()</i> = charging algorithm
Trip	<i>Temperature()</i> < T1	<ul style="list-style-type: none"> • <i>ChargingStatus()[IN]</i> = 1 • <i>ChargingVoltage()</i> = 0 • <i>ChargingCurrent()</i> = 0 • No charging is allowed if <i>Charging Configuration[CHGIN]</i> = 1.
Trip	<i>Temperature()</i> > T3 while no charging	<ul style="list-style-type: none"> • <i>ChargingStatus()[IN]</i> = 1 • <i>ChargingVoltage()</i> = 0 • <i>ChargingCurrent()</i> = 0 • No charging is allowed if <i>Charging Configuration[CHGIN]</i> = 1.

4.8 Charge Suspend

The device can stop charging at high and low temperatures to prevent damage of the cells.

Status	Condition	Action
Normal	$T1 < Temperature() < T4$	<ul style="list-style-type: none"> • $ChargingStatus()[SU] = 0$ • $ChargingVoltage() =$ charging algorithm • $ChargingCurrent() =$ charging algorithm
Trip	$Temperature() < T1$	<ul style="list-style-type: none"> • $ChargingStatus()[SU] = 1$ • $ChargingVoltage() = 0$ • $ChargingCurrent() = 0$ • No charging is allowed if $Charging Configuration[CHGSU] = 1$.
Trip	$Temperature() > T4$	<ul style="list-style-type: none"> • $ChargingStatus()[SU] = 1$ • $ChargingVoltage() = 0$ • $ChargingCurrent() = 0$ • No charging is allowed if $Charging Configuration[CHGSU] = 1$.

4.9 ChargingVoltage() Rate of Change

The device can slope the value changes from one range to another to avoid jumping between different voltage ranges.

NOTE: The host needs to read $ChargingVoltage()$ at least once a second during charging to adjust the charger accordingly.

Status	Condition	Action
Trip	$ChargingVoltage() \text{ Range Change}$	<ul style="list-style-type: none"> • $ChargingStatus()[CVR] = 1$ • $ChargingVoltage() = OldRange + n \times (New Range - Old Range) / Voltage Rate$, $n = 1.. Voltage Rate$ for Voltage Rate seconds

4.10 ChargingCurrent() Rate of Change

The device can slope the value changes from one range to another to avoid jumping between different current ranges.

NOTE: The host needs to read $ChargingCurrent()$ at least once a second during charging to adjust the charger accordingly.

Status	Condition	Action
Trip	$ChargingCurrent() \text{ Range Change}$	<ul style="list-style-type: none"> • $ChargingStatus()[CCR] = 1$ • $ChargingCurrent() = OldRange + n \times (New Range - Old Range) / Current Rate$, $n = 1.. Current Rate$ for Current Rate seconds

4.11 Charging Loss Compensation

The device can modify $ChargingVoltage()$ and $ChargingCurrent()$ to compensate losses caused by the FETs, the fuse, and the sense resistor by measuring the cell voltages directly and adjusting $ChargingCurrent()$ and $ChargingVoltage()$ accordingly.

In CONSTANT CURRENT mode, The device can increase the $ChargingVoltage()$ value to compensate the drop losses.

NOTE: The host must read *ChargingVoltage()* and/or *ChargingCurrent()* at least once a second during charging to adjust the charger accordingly.

Status	Condition	Action
Normal	$Current() > CCC \text{ Current Threshold AND } Sum(\text{Cell Voltages in } Voltages()) = \text{Charging algorithm voltage}$	<ul style="list-style-type: none"> • $ChargingStatus()[CCC] = 0$ • $ChargingVoltage() = \text{Charge Algorithm}$
Active	$Current() > CCC \text{ Current Threshold AND } Sum(\text{Cell Voltages in } Voltages()) < \text{Charging algorithm voltage}$	<ul style="list-style-type: none"> • $ChargingStatus()[CCC] = 1$ • $ChargingVoltage() = \text{Charge Algorithm} + [PackVoltage() - Sum(\text{Cell Voltages in } Voltages())]$
Limit	$[PackVoltage() - Sum(\text{Cell Voltages in } Voltages())] > CCC \text{ Voltage Threshold}$	$ChargingVoltage() = \text{Charge Algorithm} + CCC \text{ Voltage}$

Permanent Fail

5.1 Introduction

The device can permanently disable the use of the battery pack in case of a severe failure. The following actions in sequence are taken in PERMANENT FAIL (PF) mode when the **Settings:Manufacturing Status[PF_EN]** bit is enabled. An individual PF event can be enabled and disabled with **Settings:Enabled PF0–15** and **Settings:Enabled PF16–31** even after [PF_EN] bit is enabled.

1. Precharge, charge, and discharge FETs are turned off.
2. The following SBS data is changed: If charging, *BatteryStatus()[TCA]* = 1, if not charging, *BatteryStatus()[TDA]* = 1, *ChargingCurrent()* = 0, *ChargingVoltage()* = 0.
3. A backup of the internal AFE hardware registers are written to data flash: STATUS, STATE_CONTROL, OUTPUT_STATUS, FUNCTION_CONTROL, CELL_SEL, OCDV, OCDD, SCD1, SCD2
4. The black box data of the last three *SafetyStatus()* changes leading up to PF with time difference is written into data flash.
5. The cause of the permanent fail is logged into PFAAlert and PFStatus.
6. The following SBS values are preserved in data flash for failure analysis:
 - *SafetyAlert()*
 - *SafetyStatus()*
 - *PFAAlert()*
 - *PFStatus()*
 - *OperationStatus()*
 - *ChargingStatus()*
 - *GaugingStatus()*
 - *Voltages()*
 - *Temperatures()*
 - *DOD()*
7. Data flash writing is disabled, except subsequent PFStatus flags.
8. Subsequent PFs are appended to PFAAlert and PFStatus in PF Status class. PF Status is also logged separately to the Black Box Recorder 1st, 2nd, and 3rd PF Status.
9. The FUSE pin is driven high if configured for specific failures.

5.2 Black Box Recorder

The black box recorder maintains the last three updates of *SafetyStatus()* in memory. In case of permanent failure, this information is written to data flash together with the first three updates of *PFStatus()* after the PF event.

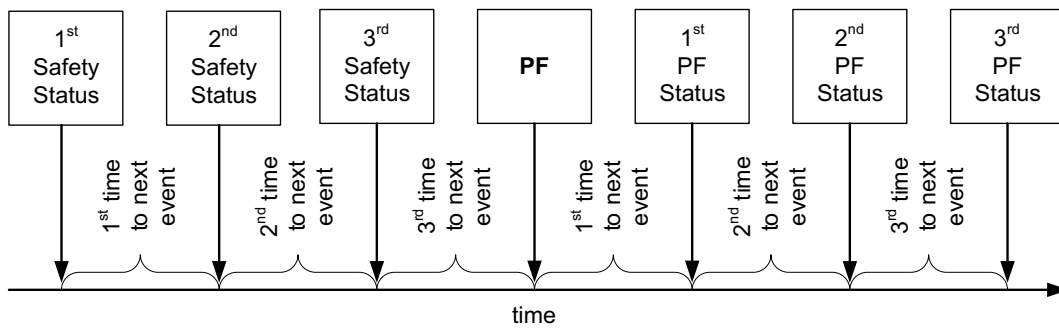

NOTE: This information is useful in failure analysis, and can provide a full recording of the events and conditions leading up to the permanent failure.

If there were less than three safety events before PF, then some information will be left blank.

5.3 Cell Undervoltage Permanent Fail

The device can permanently disable the battery in case of severe low level of cell voltage.

Status	Condition	Action
Normal	All Cell voltages in <i>Voltages()</i> > Threshold	<ul style="list-style-type: none"> <i>PFAAlert()[CUV]</i> = 0 <i>BatteryStatus()[TDA]</i> = 0
Alert	Any Cell voltages in <i>Voltages()</i> ≤ Threshold	<ul style="list-style-type: none"> <i>PFAAlert()[CUV]</i> = 1 If not charging, <i>BatteryStatus()[TDA]</i> = 1.
Trip	Any Cell voltages in <i>Voltages()</i> continuous ≤ Threshold for Delay duration AND Enabled PF 0–15[CUV] = 1	<ul style="list-style-type: none"> <i>PFAAlert()[CUV]</i> = 0 <i>PFStatus()[CUV]</i> = 1 <i>BatteryStatus()[FD]</i> = 1 If not charging, <i>BatteryStatus()[TDA]</i> = 1.

5.4 Cell Overvoltage Permanent Fail

The device can permanently disable the battery in case of severe cell overvoltage.

Status	Condition	Action
Normal	All Cell voltages in <i>Voltages()</i> < Threshold	<i>PFAAlert()[COV]</i> = 0
Alert	Any Cell voltages in <i>Voltages()</i> ≥ Threshold	<i>PFAAlert()[COV]</i> = 1
Trip	Any Cell voltages in <i>Voltages()</i> continuous ≥ Threshold for Delay duration AND Enabled PF 0–15[COV] = 1	<ul style="list-style-type: none"> <i>PFAAlert()[COV]</i> = 0 <i>PFStatus()[COV]</i> = 1 If charging, <i>BatteryStatus()[OCA]</i> = 1

5.5 Copper Deposition Permanent Fail

The device can permanently disable the battery in case of severe low level of cell voltage. The copper deposition check checks cell voltages upon wake up from SHUTDOWN mode while keeping the charge and precharge FETs off until the check is complete.

Status	Condition	Action
Normal	All Cell voltages in <i>Voltages()</i> > Threshold	<ul style="list-style-type: none"> • <i>PFAAlert()[CUDEP]</i> = 0 • <i>BatteryStatus()[TDA]</i> = 0
Alert	Any Cell voltages in <i>Voltages()</i> ≤ Threshold	<ul style="list-style-type: none"> • <i>PFAAlert()[CUDEP]</i> = 1 • If not charging, <i>BatteryStatus()[TDA]</i> = 1.
Trip	Any Cell voltages in <i>Voltages()</i> continuous ≤ Threshold for Delay duration AND Enabled PF 0–15[CUDEP] = 1	<ul style="list-style-type: none"> • <i>PFAAlert()[CUDEP]</i> = 0 • <i>PFStatus()[CUDEP]</i> = 1 • <i>BatteryStatus()[FD]</i> = 1 • If not charging, <i>BatteryStatus()[TDA]</i> = 1.

5.6 Overtemperature Cell Permanent Fail

The device can permanently disable the battery pack in case of severe overtemperature of the cells.

Status	Condition	Action
Normal	Cell Temperature in <i>Temperatures()</i> < Threshold	<i>PFAAlert()[OTCE]</i> = 0
Alert	Cell Temperature in <i>Temperatures()</i> ≥ Threshold	<i>PFAAlert()[OTCE]</i> = 1
Trip	Cell Temperature in <i>Temperatures()</i> continuous ≥ Threshold for Delay duration AND Enabled PF 0–15[OTCE] = 1	<ul style="list-style-type: none"> • <i>PFAAlert()[OTCE]</i> = 0 • <i>PFStatus()[OTCE]</i> = 1 • <i>BatteryStatus()[OTA]</i> = 1

5.7 Overtemperature FET Permanent Fail

The device can permanently disable the battery pack in case of severe overtemperature on the power FET.

Status	Condition	Action
Normal	FET Temperature in <i>Temperatures()</i> < Threshold	<i>PFAAlert()[OTF]</i> = 0
Alert	FET Temperature in <i>Temperatures()</i> ≥ Threshold	<i>PFAAlert()[OTF]</i> = 1
Trip	FET Temperature in <i>Temperatures()</i> continuous ≥ Threshold for Delay duration AND Enabled PF 0–15[OTF] = 1	<ul style="list-style-type: none"> • <i>PFAAlert()[OTF]</i> = 0 • <i>PFStatus()[OTF]</i> = 1 • <i>BatteryStatus()[OTA]</i> = 1

5.8 QMax Imbalance Permanent Fail

The device can permanently disable the battery pack in case the capacity of one of the cells is much lower than the others.

Status	Condition	Action
Normal	$\Delta(QMax\ Cell\ 0..3) < \text{Threshold}$	<i>PFAAlert()[QIM]</i> = 0
Alert	$\Delta(QMax\ Cell\ 0..3) \geq \text{Threshold}$	<i>PFAAlert()[QIM]</i> = 1
Trip	$\Delta(QMax\ Cell\ 0..3)$ continuous ≥ Threshold for Delay duration AND Enabled PF 0–15[QIM] = 1	<ul style="list-style-type: none"> • <i>PFAAlert()[QIM]</i> = 0 • <i>PFStatus()[QIM]</i> = 1

5.9 Cell Balancing Permanent Fail

The device can permanently disable the battery pack in case one of the cells in stack is cell balanced much more than the others.

Status	Condition	Action
Normal	$\Delta(\text{Time Cell } 0..3) < \text{Delta Threshold}$	$PFA\text{Alert}()[CB] = 0$
Alert	$\Delta(\text{Time Cell } 0..3) \geq \text{Delta Threshold}$	$PFA\text{Alert}()[CB] = 1$
Trip	$\Delta(\text{Time Cell } 0..3)$ continuous $\geq \text{Delta Threshold}$ for Delay duration AND Enabled PF 0–15[CB] = 1	<ul style="list-style-type: none"> $PFA\text{Alert}()[CB] = 0$ $PF\text{Status}()[CB] = 1$
Trip	Max (Time Cell 0..3) $\geq \text{Max Threshold}$ AND Enabled PF 0–15[CB] = 1	<ul style="list-style-type: none"> $PFA\text{Alert}()[CB] = 0$ $PF\text{Status}()[CB] = 1$

5.10 Capacity Degradation Permanent Fail

The device can permanently disable the battery pack in case the capacity of the cell stack is degraded below a threshold.

Status	Condition	Action
Normal	$All(QMax1..4) > \text{Threshold}$	$PFA\text{Alert}()[CD] = 0$
Alert	$Any(QMax1..4) \leq \text{Threshold}$	$PFA\text{Alert}()[CD] = 1$
Trip	$Any(QMax1..4)$ continuous $\leq \text{Threshold}$ for Delay cycles AND Enabled PF 0–15[CD] = 1	<ul style="list-style-type: none"> $PFA\text{Alert}()[CD] = 0$ $PF\text{Status}()[CD] = 1$

5.11 Impedance Permanent Fail

The device can permanently disable the battery pack in case the impedance of one of the cells is much higher than the others.

NOTE: *Reference Grid* is configurable from 0 (resistance at fully charged cell) to 14 (resistance at fully discharged cell). The *Design Resistance* will be automatically calculated and updated during learning cycle and is part of the golden image).

Status	Condition	Action
Normal	$\Delta(\text{Cell}0..3 R_a \text{ at Reference Grid}) < (\text{Delta Threshold} \times \text{Design Resistance})$	$PFA\text{Alert}()[IMP] = 0$
Alert	$\Delta(\text{Cell}0..3 R_a \text{ at Reference Grid}) \geq (\text{Delta Threshold} \times \text{Design Resistance})$	$PFA\text{Alert}()[IMP] = 1$
Trip	$\Delta(\text{Cell}0..3 R_a \text{ at Reference Grid}) \geq (\text{Delta Threshold} \times \text{Design Resistance})$ for Ra Update Counts AND Enabled PF 0–15[IMP] = 1	<ul style="list-style-type: none"> $PFA\text{Alert}()[IMP] = 0$ $PF\text{Status}()[IMP] = 1$
Trip	$\Delta(\text{Cell}0..3 R_a \text{ at Reference Grid}) \geq (\text{Max Threshold} \times \text{Design Resistance})$ AND Enabled PF 0–15[IMP] = 1	<ul style="list-style-type: none"> $PFA\text{Alert}()[IMP] = 0$ $PF\text{Status}()[IMP] = 1$

5.12 Voltage Imbalance at Rest Permanent Fail

The device can permanently disable the battery pack in case of voltage difference between the cells in a stack while at rest.

Status	Condition	Action
Normal	<ul style="list-style-type: none"> All Cell voltages in $Voltages()$ $< \text{Check Voltage}$ $Current() > \text{Check Current}$ $\Delta(\text{Cell voltages in } Voltages()) < \text{Delta Threshold}$ 	$PFA\text{Alert}()[VIMR] = 0$
Alert	Any Cell voltages in $Voltages() \geq \text{Check Voltage}$ AND $ Current() $ continuous $< \text{Check Current}$ for Duration AND $\Delta(\text{Cell voltages in } Voltages()) \geq \text{Delta Threshold}$	$PFA\text{Alert}()[VIMR] = 1$

Status	Condition	Action
Trip	[Any Cell voltages in <i>Voltages()</i> \geq Check Voltage AND <i>Current()</i> continuous $<$ Check Current for Duration AND Δ (Cell voltages in <i>Voltages()</i>) \geq Delta Threshold] for Delay duration AND Enabled PF 0–15[VIMR] = 1	<ul style="list-style-type: none"> • <i>PFAAlert()[VIMR]</i> = 0 • <i>PFStatus()[VIMR]</i> = 1

5.13 Voltage Imbalance Active Permanent Fail

The device can permanently disable the battery pack in case of voltage difference between the cells in a stack while active.

Status	Condition	Action
Normal	<ul style="list-style-type: none"> • All Cell voltages in <i>Voltages()</i> $<$ Check Voltage • <i>Current()</i> $<$ Check Current • Δ(Cell voltages in <i>Voltages()</i>) $<$ Delta Threshold 	<i>PFAAlert()[VIMA]</i> = 0
Alert	Any Cell voltages in <i>Voltages()</i> \geq Check Voltage AND <i>Current()</i> continuous $>$ Check Current for Duration AND Δ (Cell voltages in <i>Voltages()</i>) \geq Delta Threshold	<i>PFAAlert()[VIMA]</i> = 1
Trip	[Any Cell voltages in <i>Voltages()</i> \geq Check Voltage AND <i>Current()</i> continuous $>$ Check Current for Duration AND Δ (Cell voltages in <i>Voltages()</i>) continuous \geq Delta Threshold] for Delay duration AND Enabled PF 0–15[VIMA] = 1	<ul style="list-style-type: none"> • <i>PFAAlert()[VIMA]</i> = 0 • <i>PFStatus()[VIMA]</i> = 1

5.14 Charge FET Permanent Fail

The device can permanently disable the battery pack in case the charge FET is not working properly.

Status	Condition	Action
Normal	CHG FET off AND <i>Current()</i> $<$ OFF Threshold	<i>PFAAlert()[CFETF]</i> = 0
Alert	CHG FET off AND <i>Current()</i> \geq OFF Threshold	<i>PFAAlert()[CFETF]</i> = 1
Trip	CHG FET off AND <i>Current()</i> continuously \geq OFF Threshold for Delay duration AND Enabled PF 16–32[CFETF] = 1	<ul style="list-style-type: none"> • <i>PFAAlert()[CFETF]</i> = 0 • <i>PFStatus()[CFETF]</i> = 1

5.15 Discharge FET Permanent Fail

The device can permanently disable the battery pack in case the discharge FET is not working properly.

Status	Condition	Action
Normal	DSG FET off AND <i>Current()</i> $>$ OFF Threshold	<i>PFAAlert()[DFET]</i> = 0
Alert	DSG FET off AND <i>Current()</i> \leq OFF Threshold	<i>PFAAlert()[DFET]</i> = 1
Trip	DSG FET off AND <i>Current()</i> continuously \leq OFF Threshold for Delay duration AND Enabled PF 16–32[DFET] = 1	<ul style="list-style-type: none"> • <i>PFAAlert()[DFET]</i> = 0 • <i>PFStatus()[DFET]</i> = 1

5.16 Thermistor Permanent Fail

The device can permanently disable the battery pack when it detects an open (internally pulled up) or short (grounded) failure in the thermistor circuit. When a fault is Detected, the *PFAAlert()[TH]* bit will be set to 1. If the fault is still present after the Permanent Fail:ADC Delay time, the *PFAAlert()[TH]* bit will be cleared and *PFStatus()[TH]* will be set to 1.

5.17 Chemical Fuse Permanent Fail

The device can detect a non-working fuse. The device cannot disable the battery pack permanently, but can record this event for analysis.

Status	Condition	Action
Normal	FUSE pin = high AND $ Current() < \text{Threshold}$	$PFAAlert()[FUSE] = 0$
Alert	FUSE pin = high AND $ Current() \geq \text{Threshold}$	$PFAAlert()[FUSE] = 1$
Trip	FUSE pin = high AND $ Current() $ continuous \geq Threshold for Delay duration AND Enabled PF 16–32[FUSE] = 1	<ul style="list-style-type: none"> $PFAAlert()[FUSE] = 0$ $PFStatus()[FUSE] = 1$

5.18 AFE Register Permanent Fail

The device compares the AFE hardware register periodically with a RAM backup. If the comparison fails too many times, the device disables the pack permanently.

Status	Condition	Action
Normal	AFE register fail counter = 0	<ul style="list-style-type: none"> $PFAAlert()[AFER] = 0$ Compare AFE register and RAM backup every Compare Period
Alert	AFE register fail counter > 0	<ul style="list-style-type: none"> $PFAAlert()[AFER] = 1$ Decrement AFE register fail counter by one after each Delay Period Compare AFE register and RAM backup every Compare Period
Trip	AFE register fail counter \geq Threshold AND Enabled PF 16–32[AFER] = 1	<ul style="list-style-type: none"> $PFAAlert()[AFER] = 0$ $PFStatus()[AFER] = 1$

5.19 AFE Communication Permanent Fail

The device monitors the internal communication to the AFE hardware. If the read or write fails exceed a limit within a timeframe, the device disables the pack permanently.

Status	Condition	Action
Normal	AFE read/write fail counter = 0	$PFAAlert()[AFEC] = 0$
Alert	AFE read/write fail counter > 0	<ul style="list-style-type: none"> $PFAAlert()[AFEC] = 1$ Decrement AFE read/write fail counter by one after each Delay period
Trip	Read and Write Fail counter \geq Threshold AND Enabled PF 16–32[AFEC] = 1	<ul style="list-style-type: none"> $PFAAlert()[AFEC] = 0$ $PFStatus()[AFEC] = 1$

5.20 Second Level Protection Permanent Fail

The device can detect external trigger of the chemical fuse by an external protection circuit such as a 2nd-level protector by monitoring the FUSE pin state.

If the device detects FUSE pin high state, the CHG and DSG FET are turned off.

Status	Condition	Action
Normal	Reset AFE and FUSE pin = low AND no FUSE trigger by firmware	<ul style="list-style-type: none"> • $PFAAlert()[2LVL] = 0$ • Reset internal PF 2LVL counter
Alert	FUSE pin = high AND no FUSE trigger by firmware	<ul style="list-style-type: none"> • $PFAAlert()[2LVL] = 1$ • Increment internal PF 2LVL counter • Wait for PF 2LVL Delay time • Reset AFE
Trip	Internal PF 2LVL counter > Threshold AND Enabled PF 16–32[2LVL] = 1	<ul style="list-style-type: none"> • $PFAAlert()[2LVL] = 0$ • $PFStatus()[2LVL] = 1$

5.21 PTC Permanent Fail

The device can detect overtemperature using a positive temperature coefficient (PTC) resistor connected to PTC pin. This protection also works in SHUTDOWN mode.

If the device detects PTC pin high state, the CHG and DSG FET are turned off. Pack is disabled permanently. State can only be reset by fully power cycle the device.

If PTC permanent fail is not used, the PTC pin should be connected to VSS with a 10-kΩ resistor.

Status	Condition	Action
Normal	Reset AFE and PTC pin = low AND no FUSE trigger by firmware	$PFStatus()[PTC] = 0$
Trip	PTC pin = high	<ul style="list-style-type: none"> • $PFStatus()[PTC] = 1$ • FUSE = high

5.22 Instruction Flash Checksum Permanent Fail

The device can permanently disable the battery in case it detects a difference between the stored IF checksum and the calculated IF checksum right after device reset.

Status	Condition	Action
Normal	Stored and calculated IF checksum match	$PFAAlert()[IFC] = 0$
Trip	Stored and calculated IF checksum after reset don't match AND Enabled PF 16–32[IFC] = 1	<ul style="list-style-type: none"> • $PFAAlert()[IFC] = 0$ • $PFStatus()[IFC] = 1$

5.23 Open Cell Voltage Connection Permanent Fail

The device can permanently disable the battery in case it detects a difference between the BAT pin voltage and the sum of the individual cell voltages.

Status	Condition	Action
Normal	$ \text{Sum}(\text{Cell voltages in } Voltages()) - \text{BAT voltage in } Voltages()) < \text{Threshold}$	$PFAAlert()[OCECO] = 0$
Alert	$ \text{Sum}(\text{Cell voltages in } Voltages()) - \text{BAT voltage in } Voltages()) \geq \text{Threshold}$	$PFAAlert()[OCECO] = 1$
Trip	$ \text{Sum}(\text{Cell voltages in } Voltages()) - \text{BAT voltage in } Voltages()) \text{ continuous } \geq \text{Threshold for Delay Period AND } \text{Enabled PF 16–32}[OCECO] = 1$	<ul style="list-style-type: none"> • $PFAAlert()[OCECO] = 0$ • $PFStatus()[OCECO] = 1$

5.24 Data Flash Permanent Fail

The device can permanently disable the battery in case a data flash write fails.

Status	Condition	Action
Normal	Data flash write ok	<i>PFA</i> Alert()[DFW] = 0
Trip	Data flash write not successful AND Enabled PF 16–32 [DFW] = 1	<ul style="list-style-type: none"> • <i>PFA</i>Alert()[DFW] = 0 • <i>PFA</i>Status()[DFW] = 1

Power Modes

To enhance battery life, the bq30z50-R1 and bq30z55-R1 support different power modes to save power and minimize power consumption during operation.

6.1 NORMAL Mode

In NORMAL mode, the device takes voltage, current, and temperature readings every 250 ms, performs protection and gauging calculations, and updates SBS data. Between these periods of activity, the device is in a reduced power state.

6.2 SLEEP Mode

6.2.1 Device Sleep

When the sleep conditions are met, the device goes to SLEEP mode with periodic wake-ups to reduce power consumption. The device returns to NORMAL mode if SBS communication and current is detected.

Status	Condition	Action
Enable	System Configuration[SLEEP] = 1	<i>OperationStatus()[SLEEP] = 1</i>
Activate	System Configuration[NR] = 0 AND <i>OperationStatus()[PRES] = 0 AND Current() < Sleep:Sleep Current AND SMBus clock and data lines low for 5 s.</i>	<ul style="list-style-type: none"> • Turn off CHG FET, DSG FET, PCHG FET • Device goes to sleep • Device wakes up every Sleep Voltage Time period to measure voltage and temperature • Device wakes up every Sleep Current Time period to measure current
Activate	System Configuration[NR] = 1 AND Current() < Sleep:Sleep Current AND SMBus clock and data lines low for 5 s.	<ul style="list-style-type: none"> • Turn off CHG FET, PHCG FET if System Configuration[SLEEPCHG] = 0 • Device goes to sleep • Device wakes up every Sleep Voltage Time period to measure voltage and temperature • Device wakes up every Sleep Current Time period to measure current
Exit	System Configuration[NR] = 0 AND <i>OperationStatus()[PRES] = 1</i>	Return to NORMAL mode
Exit	 Current() > Sleep:Sleep Current	Return to NORMAL mode
Exit	SMBus clock and data lines high	Return to NORMAL mode
Exit	Wake comparator trips	Return to NORMAL mode
Exit	<i>SafetyAlert()</i> flag or <i>PFAAlert()</i> flag set	Return to NORMAL mode

6.2.1.1 Wake Function

The device can exit SLEEP mode, if enabled, by the presence of a voltage across SRP and SRN. The level of the current signal needed is programmed in Power:Wake Current Reg.

	Bit 7	Bit 6	Bit 5	Bit 4	Bit 3	Bit 2	Bit 1	Bit 0
Low Byte	RSVD	RSVD	RSVD	RSVD	RSVD	IWAKE	RSNS1	RSNS0

Reserved (Bits 7–3): Reserved, do not use.

IWAKE (Bit 2):

0 = 0.5A (Or if RSNS0=RSNS1=0, then this function is disabled.)

1 = 1.0A (Or if RSNS0=RSNS1=0, then this function is disabled.)

RSNS1	RSNS0	Resistance
0	0	Disabled (default)
0	1	2.5 mΩ
1	0	5 mΩ
1	1	10 mΩ

6.2.2 ManufacturerAccess Sleep

The device can be sent to sleep with *ManufacturerAccess()* if the sleep conditions are met. This function is used to test sleep exit conditions.

6.3 SHIP Mode

In SHIP mode, the device enters a low power mode with no voltage, current, and temperature measurements.

6.3.1 SHIP HIBERNATE Mode

In SHIP HIBERNATE mode, the device enters a low-power mode with no voltage, current, and temperature measurements, the FETs are turned off, and the MCU is in a halt state. The device will return to NORMAL mode on SBS communication detection. The device can be configured to ship hibernate with discharge FET on through Settings:System Configuration[SHIPDSG]. The device can be sent to this mode with *ManufacturerAccess()* Ship command.

6.3.2 SHIP SHUTDOWN Mode

In SHIP SHUTDOWN mode, the device shuts down to minimize power consumption, and the FETs are turned off. The device will return to NORMAL mode when voltage at PACK pin > VSTARTUP. The device can be sent to this mode with the *ManufacturerAccess()* Shutdown command. Charger voltage must not be present for the device to enter SHIP SHUTDOWN mode.

6.4 SHUTDOWN Mode

6.4.1 Voltage Based Shutdown

The device can be configured to shut down at a programmable stack voltage threshold to minimize power consumption and avoid draining the battery. This function also works in PERMANENT FAILURE mode to prevent polymer cell swelling.

Status	Condition	Action
Enable	Min(Cell Voltage in <i>Voltages()</i>) < Shutdown Voltage	<i>OperationStatus()[SDV]</i> = 1
Activate	Min(Cell Voltage in <i>Voltages()</i>) continuous < Shutdown Voltage for Shutdown Time	The device disables everything and turns off.
Exit	Voltage at PACK pin > VSTARTUP	<ul style="list-style-type: none"> <i>OperationStatus()[SDV]</i>= 0 Return to NORMAL mode

Gauging

7.1 Impedance Track

The device features the most advanced Impedance Track gauging algorithm v3.75, and is capable of supporting a maximum battery pack capacity of 32 Ah. The algorithm estimates run time and capacity.

The Impedance Track algorithm v3.75 features the following:

- Cell balancing during relax (CBR)
- Ability to learn Qmax without a rest period following the end of discharge (FAST_QMax)
- Compatible with LiFePO4 chemistries (LFP_RELAX)
- Greatly improved low temperature accuracy
- Greatly improved RSOC convergence to 0% at EDV (RSOC_CONV)
- Detailed status information via SBS for convenient debug and evaluation (no GG logging necessary)
 - DOD0
 - Qpassed
 - Grid numbers
 - Ra calculations
 - Balance timers
- Option to apply low pass filter smoothing to RemCap and FCC (SMOOTH)
- Option to prevent RSOC jumps during discharge (RSOC_HOLD)

7.2 Gas Gauge Mode

Status	Condition	Action
Charge	$Current() > \text{Chg Current Threshold}$	<ul style="list-style-type: none"> • $GaugingStatus()[DSG] = 0$ • $GaugingStatus()[REST] = 0$
Relax	$GaugingStatus()[DSG] = 0-1$ transition AND $ Current() < \text{Quit Current Threshold for Chg Relax Time}$	<ul style="list-style-type: none"> • $GaugingStatus()[DSG] = 1$ • $GaugingStatus()[REST] = 1$, if: • DOD0 updated and • OCV updated and • QMax updated
Relax	$GaugingStatus()[DSG] = 1-0$ transition AND $ Current() < \text{Quit Current Threshold for Dsg Relax Time}$	<ul style="list-style-type: none"> • $GaugingStatus()[DSG] = 1$ • $GaugingStatus()[REST] = 1$, if: • DOD0 updated and • OCV updated and • QMax updated
Discharge	$Current() < (-) \text{Dsg Current Threshold}$	<ul style="list-style-type: none"> • $GaugingStatus()[DSG] = 1$ • $GaugingStatus()[REST] = 0$ • RA update

LED Display

The device has a LED display that can show various status information.

Status	Condition	Action
Activate	High—low transition of \overline{DISP} pin	<ul style="list-style-type: none"> LED Display shows state of charge for LED Support:LED Hold Time LED Display shows each active PF code for 2x LED Hold Time if Settings:LED Configuration[LEDPF1][LEDPF0] = 0,1
Activate	Settings: LED Configuration [LEDR] = 1 AND device reset	<ul style="list-style-type: none"> LED Display shows state of charge for LEDSupport:LED Hold Time LED Display shows each active PF code for 2x LED Hold Time if Settings:LED Configuration[LEDPF1][LEDPF0] = 0,1
Activate	Settings: LED Configuration [LEDRCA] = 1 AND BatteryStatus[RCA] 0 to 1 transition	LED Display flashes with LED Flash Rate
Activate	Settings: LED Configuration [LEDCHG] = 1 AND <i>Current()</i> > 0	<ul style="list-style-type: none"> LED Display shows state of charge for LEDSupport:LED Hold Time LED Display shows each active PF code for 2x LED Hold Time if Settings:LED Configuration[LEDPF1][LEDPF0] = 0,1
Activate	<i>ManufacturerStatus()</i> = 0x002C	<ul style="list-style-type: none"> LED Display shows state of charge for LED Support:LED Hold Time LED Display shows each active PF code for 2x LED Hold Time if Settings:LED Configuration[LEDPF1][LEDPF0] = 0,1
Toggle	<i>ManufacturerStatus()</i> = 0x002B	Toggle LED on or off
Disabled	<i>SafetyStatus()</i> [CUV] = 1	LED Display Disabled

8.1 LED Display State of Charge

The state of charge can display *RelativeStateOfCharge()* or *AbsoluteStateOfCharge()/DesignCapacity()*, selectable with Settings:**LED Configuration**[LEDMODE]. All data flash settings are available through LED Support:LED Config subclass.

	State of Charge	
	<i>Current()</i> > 0	<i>Current()</i> <= 0
Flash Alert	0% – CHG Flash Alarm	0% – DSG Flash Alarm
LED1	CHG Thresh 1 – 100%	DSG Thresh 1 – 100%
LED2	CHG Thresh 2 – 100%	DSG Thresh 2 – 100%
LED3	CHG Thresh 3 – 100%	DSG Thresh 3 – 100%
LED4	CHG Thresh 4 – 100%	DSG Thresh 4 – 100%
LED5	CHG Thresh 5 – 100%	DSG Thresh 5 – 100%

8.2 LED Display PF Codes

Each active PF code is shown for 2x **LED Hold Time** with lowest priority to highest priority.

PF Flag	Priority	LED3	LED2	LED1
No PF	0	LED Blink Period	off	off
CUV	0	LED Blink Period	on	off
COV	1	LED Blink Period	LED Flash Period	off
CUDEP	2	Fast Blink	off	on
OTCE	3	LED Blink Period	LED Flash Period	on
OTF	4	LED Blink Period	On	LED Flash Period
QIM	5	LED Blink Period	LED Flash Period	LED Flash Period
CB	6	LED Blink Period	off	LED Blink Period
IMP	7	LED Blink Period	on	LED Blink Period
CD	8	LED Flash Period	LED Blink Period	off
VIMR	9	off	LED Blink Period	off
VIMA	10	on	LED Blink Period	off
CFETF	11	LED Flash Period	LED Blink Period	LED Flash Period
DFETF	12	off	LED Blink Period	LED Flash Period
THERM	13	on	LED Blink Period	LED Flash Period
FUSE	14	LED Flash Period	LED Blink Period	LED Blink Period
AFE_P	15	off	LED Blink Period	LED Blink Period
AFE_C	16	on	off	LED Blink Period
2LVL	17	LED Flash Period	off	LED Blink Period
Reserved	18	off	off	LED Blink Period
Reserved	19	on	on	LED Blink Period
OCECO	20	LED Flash Period	on	LED Blink Period
DFW	21	off	on	LED Blink Period

Lifetime Data Collection

The device has extensive capabilities logging events over life of battery useful for analysis. The data is collected in RAM and only written DF under following conditions to avoid wear out of flash:

- Every 10 hours if RAM content is different from flash
- In permanent fail, before data flash updates are disabled.
- A reset counter increments
- Before scheduled shutdown
- Before low voltage shutdown

The lifetime data stops collecting under following conditions:

- After permanent fail
- Lifetime Data collection is disabled

Total firmware Runtime starts when lifetime data is enabled.

- Voltage
 - Max/Min Cell Voltage Each Cell
 - Max Delta Voltage
- Current
 - Max Charge/Discharge Current
 - Max Average Discharge Current
 - Max Average Discharge Power
- Safety Events (12 most common are tracked)
 - Number of Safety Events
 - Cycle Count at Last Safety Event(s)
- Charging Events
 - Number of Valid Charge Terminations
 - Cycle Count at Last Charge Termination
- Gauging Events
 - Number of QMax updates
 - Cycle Count at Last QMax update
 - Number of RA updates
 - Cycle Count at Last RA update
- Power Events: Number of Resets
- Cell Balancing
 - Cell Balancing Time each Cell
- Temperature
 - Max/Min Cell Temp
 - Delta Cell Temp
 - Max/Min Int Temp Sensor
 - Max FET Temp
- Time

- Total runtime
- Time spent different temperature ranges

Device Security

10.1 Description

The device uses the SHA-1 one-way hash function for device authentication by the host system. UNSEAL or FULL ACCESS mode is also protected using SHA-1 authentication.

10.2 SHA-1 Description

The SHA-1 is known as a one-way hash function, meaning there is no known mathematical method of computing the input given only the output. The specification of the SHA-1, as defined by FIPS 180–2, states that the input consists of 512-bit blocks with a total input length less than 264 bits. Inputs that do not conform to integer multiples of 512-bit blocks are padded before any block is input to the hash function. The SHA-1 algorithm outputs 160 bits, commonly referred to as the digest.

(As of April 23, 2004, the latest revision is FIPS 180–2.) SHA-1 or secure hash algorithm is used to compute a condensed representation of a message or data also known as hash. For messages $< 2^{64}$ the SHA-1 produces an 160-bit output called digest.

The device generates an SHA-1 input block of 288 bits (total input = 160 bit message + 128 bit key). To complete the 512-bit block size requirement of the SHA-1, the device pads the key and message with a 1, followed by 159 0s, followed by the 64 bit value for 288 (000...00100100000), which conforms to the pad requirements specified by FIPS 180–2.

Detailed information about the SHA-1 algorithm can be found:

1. <http://www.itl.nist.gov/fipspubs/fip180-1.htm>
2. <http://csrc.nist.gov/publications/fips>
3. www.faqs.org/rfcs/rfc3174.html

10.3 HMAC Description

The SHA-1 engine is used to calculate a modified HMAC value. Using a public message and a secret key, the HMAC output is considered to be a secure fingerprint that authenticates the device used to generate the HMAC.

To compute the HMAC let H designate the SHA-1 hash function, M designate the message transmitted to the device, and KD designate the unique 128 bit unseal/full access/authentication key of the device. HMAC(M) is defined as:

$H[KD || H(KD || M)]$, where || symbolizes an append operation.

The message, M, is appended to the unseal/full access/authentication key, KD, and padded to become the input to the SHA-1 hash. The output of this first calculation is then appended to the unseal/full access/authentication key, KD, padded again, and cycled through the SHA-1 hash a second time. The output is the HMAC digest value.

10.4 Authentication

1. Generate 160-bit message M using a random number generator that meets approved random number generators described in FIPS PUB 140–2.
2. Generate SHA-1 input block B1 of 512 bytes (total input = 128-bit authentication key KD + 160 bit message M + 1 + 159 0s + 100100000).
3. Generate SHA-1 hash HMAC1 using B1.
4. Generate SHA-1 input block B2 of 512 bytes (total input = 128-bit authentication key KD + 160 bit hash

- HMAC1 + 1 + 159 0s + 100100000).
5. Generate SHA-1 hash HMAC2 using B2.
 6. With no active *ManufacturerInput()* data waiting, write 160-bit message M to *ManufacturerInput()* in the format 0xAABBCCDDEEFFGGHHIIJJKLLMMNNOOPPQRRSSTT, where AA is LSB.
 7. Wait 250 ms, then read *ManufacturerInput()* for HMAC3.
 8. Compare host HMAC2 with device HMAC3, it matches, both host and device have the same key KD and device is authenticated.

10.5 Unseal/Full Access

1. Send Unseal (0x0031) or Full Access (0x0032) command to *ManufacturerAccess()*.
2. Read 160-bit message M from *ManufacturerInput()* in the format 0xAABBCCDDEEFFGGHHIIJJKLLMMNNOOPPQRRSSTT, where AA is LSB.
3. Generate SHA-1 input block B1 of 512 bytes (total input =128-bit unseal/full access key KD + 160 bit message M + 1 + 159 0s + 100100000).
4. Generate SHA-1 hash HMAC1 using B1.
5. Generate SHA-1 input block B2 of 512 bytes (total input =128-bit unseal/full access key KD + 160 bit hash HMAC1 + 1 + 159 0s + 100100000).
6. Generate SHA-1 hash HMAC2 using B2.
7. Write 160-bit hash HMAC2 to *ManufacturerInput()* in the format 0xAABBCCDDEEFFGGHHIIJJKLLMMNNOOPPQRRSSTT, where AA is LSB.
8. Device compares hash HMAC2 with internal calculated hash HMAC3. If it matches, device allows UNSEALED/FULL ACCESS mode indicated with the *OperationStatus()[SEC1],[SEC0]* flags.

SBS Commands

11.1 0x00 ManufacturerAccess()

The *ManufacturerAccess()* command has several functions depending on the data written to this command.

11.1.1 0x0000 ManufacturerData

This command returns *ManufacturerData()* information.

Status	Condition	Action
Activate	0x0000 to <i>ManufacturerAccess()</i>	Output <i>ManufacturerData()</i> on <i>ManufacturerData()</i>

11.1.2 0x0001 Device Type

The device can be checked for the IC part number.

Status	Condition	Action
Enable	0x0001 to <i>ManufacturerAccess()</i>	<ul style="list-style-type: none"> Returns the IC part number on subsequent read on <i>ManufacturerData()</i> in the following format: aaAA, where: aaAA: Device type

11.1.3 0x0002 Firmware Version

The device can be checked for the firmware version of the IC.

Status	Condition	Action
Enable	0x0002 to <i>ManufacturerAccess()</i>	<ul style="list-style-type: none"> Returns the firmware revision on <i>ManufacturerData()</i> in the following format: ddDDvvVVbbBBttzzZZRREE, where: ddDD: Device Number vvVV: Version bbBB: build number tt: Firmware type zzZZ: Impedance Track Version RR: Reserved EE: Reserved
Enable	Write following sequence within 4 seconds; also works in SEALED mode: <ol style="list-style-type: none"> Block write to 0x22 with block size 62 Block write to 0x20 with block size 62 Block write to 0x22 with block size 62 	<ul style="list-style-type: none"> Returns the firmware revision on <i>ManufacturerData()</i> in the following format: ddDDvvVVbbBBttzzZZRREE, where: ddDD: Device Number vvVV: Version bbBB: Build number tt: Firmware type zzZZ: Impedance Track Version RR: Reserved EE: Reserved

11.1.4 0x0003 Hardware Version

The device can be checked for the hardware version of the IC.

Status	Condition	Action
Enable	0x0003 to <i>ManufacturerAccess()</i>	Returns the hardware revision on subsequent read on <i>ManufacturerData()</i>

11.1.5 0x0004 Instruction Flash Checksum

The device can return the instruction flash checksum.

Status	Condition	Action
Enable	0x0004 to <i>ManufacturerAccess()</i>	Returns the IF checksum on subsequent read on <i>ManufacturerData()</i> after a wait time of 250 ms

11.1.6 0x0005 Data Flash Checksum

The device can return the data flash checksum.

Status	Condition	Action
Enable	0x0005 to <i>ManufacturerAccess()</i>	Returns the DF checksum on subsequent read on <i>ManufacturerData()</i> after a wait time of 250 ms. Only static DF items are included in the checksum. No items modified by the device or items that are different device to device are included.

11.1.7 0x0006 Chemical ID

This command returns the chemical ID of the OCV tables used in the gauging algorithm.

Status	Condition	Action
Enable	0x0006 to <i>ManufacturerAccess()</i>	Returns the chemical ID on subsequent read on <i>ManufacturerData()</i>

11.1.8 0x0010 Shutdown Mode

The device can be sent to SHUTDOWN mode before shipping to reduce power consumption to a minimum. The device will wake up when a voltage is applied to PACK.

Status	Condition	Action
Normal	<i>OperationStatus()</i> [SH] = 0	
Enable	0x0010 to <i>ManufacturerAccess()</i> ; when sealed, two times in a row	<i>OperationStatus()</i> [SD] = 1
Trip	[NR] = 1 AND <i>Current()</i> = 0 AND Voltage on PACK = 0	FETs are turned off after Power:Shutdown time. Device will enter SHUTDOWN mode after another passage of Power:Shutdown time. (That is, 2x of the Shutdown time after the command is set and 1x of the Shutdown time after the FETs are off.)
Trip	Delay after command is sent > Power:Shutdown Time	No charging or discharging is allowed; device is shutdown.

11.1.9 0x0011 Sleep Mode

The device can be sent to sleep with *ManufacturerAccess()* if the sleep conditions are met.

Status	Condition	Action
Enable	0x0011 to <i>ManufacturerAccess()</i>	<i>OperationStatus()</i> [SLEEPM] = 1
Activate	Settings:System Configuration[NR] = 0 AND <i>OperationStatus()</i> [PRES] = 0 AND <i>Current()</i> < Power:Sleep Current	<ul style="list-style-type: none"> • Turn off CHG FET, DSG FET, PCHG FET • Device goes to sleep • Device wakes up every Power:Sleep Voltage Time period to measure voltage and temperature • Device wakes up every Power:Sleep Current Time period to measure current
Activate	Settings:System Configuration:System[NR] = 1 AND <i>Current()</i> < Power:Sleep Current	<ul style="list-style-type: none"> • Turn off DSG FET, PCHG FET • Turn off CHG FET if Settings:System Configuration[SLEEPCHG] = 0 • Device goes to sleep • Device wakes up every Power:Sleep Voltage Time period to measure voltage and temperature • Device wakes up every Power:Sleep Current Time period to measure current
Exit	Settings:System Configuration[NR] = 0 AND <i>OperationStatus()</i> [PRES] = 1	<ul style="list-style-type: none"> • <i>OperationStatus()</i>[SLEEPM] = 0 • Return to NORMAL mode
Exit	<i>Current()</i> > Power:Sleep Current	<ul style="list-style-type: none"> • <i>OperationStatus()</i>[SLEEPM] = 0 • Return to NORMAL mode
Exit	Wake Comparator trips	<ul style="list-style-type: none"> • <i>OperationStatus()</i>[SLEEPM] = 0 • Return to NORMAL mode
Exit	<i>SafetyAlert()</i> flag or <i>PFAlert()</i> flag set	<ul style="list-style-type: none"> • <i>OperationStatus()</i>[SLEEPM] = 0 • Return to NORMAL mode

11.1.10 0x0012 Device Reset

This command resets the device.

Status	Condition	Action
Enable	0x0012 to <i>ManufacturerAccess()</i>	Reset the device

11.1.11 0x001d Fuse Toggle

This command activate/deactivate FUSE pin for ease of manufacturing testing.

Status	Condition	Action
Disable	<i>OperationStatus()</i> [FUSE] = 1 AND 0x001d to <i>ManufacturerAccess()</i>	<ul style="list-style-type: none"> • <i>OperationStatus()</i>[FUSE] = 0 • FUSE pin drive low
Enable	<i>OperationStatus()</i> [FUSE] = 0 AND 0x001d to <i>ManufacturerAccess()</i>	<ul style="list-style-type: none"> • <i>OperationStatus()</i>[FUSE] = 1 • FUSE pin drive high

11.1.12 0x001e PRE-CHG FET

This command turns on/off Pre-CHG FET drive function to ease testing during manufacturing.

Status	Condition	Action
Disable	<i>ManufacturingStatus()</i> [FET][PCHG] = 0,1 AND 0x001e to <i>ManufacturerAccess()</i>	<ul style="list-style-type: none"> • <i>ManufacturingStatus()</i>[FET][PCHG] = 0,0 • Precharge function defined with PCHG1,PCHG0 turns off
Enable	<i>ManufacturingStatus()</i> [FET][PCHG] = 0,0 AND 0x001e to <i>ManufacturerAccess()</i>	<ul style="list-style-type: none"> • <i>ManufacturingStatus()</i>[FET][PCHG] = 0,1 • Precharge function defined with PCHG1,PCHG0 turns on

11.1.13 0x001f CHG FET

This command turns on/off CHG FET drive function to ease testing during manufacturing.

Status	Condition	Action
Disable	<i>ManufacturingStatus()</i> [FET][CHG] = 0,1 AND 0x001f to <i>ManufacturerAccess()</i>	<ul style="list-style-type: none"> • <i>ManufacturingStatus()</i>[FET][CHG] = 0,0 • CHG FET turns off
Enable	<i>ManufacturingStatus()</i> [FET][CHG] = 0,0 AND 0x001f to <i>ManufacturerAccess()</i>	<ul style="list-style-type: none"> • <i>ManufacturingStatus()</i>[FET][CHG] = 0,1 • CHG FET turns on

11.1.14 0x0020 DSG FET

This command turns on/off DSG FET drive function to ease testing during manufacturing.

Status	Condition	Action
Disable	<i>ManufacturingStatus()</i> [FET][DSG] = 0,1 AND 0x0020 to <i>ManufacturerAccess()</i>	<ul style="list-style-type: none"> • <i>ManufacturingStatus()</i>[FET][DSG] = 0,0 • DSG FET turns off
Enable	<i>ManufacturingStatus()</i> [FET][DSG] = 0,0 AND 0x0020 to <i>ManufacturerAccess()</i>	<ul style="list-style-type: none"> • <i>ManufacturingStatus()</i>[FET][DSG] = 0,1 • DSG FET turns on

11.1.15 0x0021 Gauging

This command enables or disable the gauging function to ease testing during manufacturing.

Status	Condition	Action
Disable	<i>ManufacturingStatus()</i> [Gauge] = 1 AND 0x0021 to <i>ManufacturerAccess()</i>	<ul style="list-style-type: none"> • <i>ManufacturingStatus()</i>[Gauge] = 0 • Disable gauging feature
Enable	<i>ManufacturingStatus()</i> [Gauge] = 0 AND 0x0021 to <i>ManufacturerAccess()</i>	<ul style="list-style-type: none"> • <i>ManufacturingStatus()</i>[Gauge] = 1 • Enable gauging feature

11.1.16 ManufacturerAccess() 0x0022 FET Control

This command enables/disables control of the CHG, DSG, and PCHG FET by the firmware.

Status	Condition	Action
Disable	<i>ManufacturingStatus()</i> [FET] = 1 AND 0x0022 to <i>ManufacturerAccess()</i>	<ul style="list-style-type: none"> • <i>ManufacturingStatus()</i>[FET] = 0 • CHG, DSG and PCHG FET are disabled and remain OFF
Enable	<i>ManufacturingStatus()</i> [FET] = 0 AND 0x0022 to <i>ManufacturerAccess()</i>	<ul style="list-style-type: none"> • <i>ManufacturingStatus()</i>[FET] = 1 • CHG, DSG and PCHG FET are controlled by the firmware

11.1.17 ManufacturerAccess() 0x0023 Lifetime Data Collection

This command enables/disables Lifetime data collection for ease of manufacturing.

Status	Condition	Action
Disable	<i>ManufacturingStatus()</i> [LF] = 1 AND 0x0023 to <i>ManufacturerAccess()</i>	<ul style="list-style-type: none"> • <i>ManufacturingStatus()</i>[LF] = 0 • Lifetime Data collection feature disabled
Enable	<i>ManufacturingStatus()</i> [LF] = 0 AND 0x0023 to <i>ManufacturerAccess()</i>	<ul style="list-style-type: none"> • <i>ManufacturingStatus()</i>[LF] = 1 • Lifetime Data collection feature enabled

11.1.18 ManufacturerAccess() 0x0024 Permanent Failure

This command enables/disables Permanent Failure for ease of manufacturing.

Status	Condition	Action
Disable	<i>ManufacturingStatus() [PF] = 1 AND 0x0024 to ManufacturerAccess()</i>	<ul style="list-style-type: none"> • <i>ManufacturingStatus() [PF] = 0</i> • Permanent Failure feature disabled
Enable	<i>ManufacturingStatus() [PF] = 0 AND 0x0024 to ManufacturerAccess()</i>	<ul style="list-style-type: none"> • <i>ManufacturingStatus() [PF] = 1</i> • Permanent Failure feature enabled

11.1.19 ManufacturerAccess() 0x0025 Black Box Recorder

This command enables/disables Black box recorder function for ease of manufacturing.

Status	Condition	Action
Disable	<i>ManufacturingStatus() [BBR] = 1 AND 0x0025 to ManufacturerAccess()</i>	<ul style="list-style-type: none"> • <i>ManufacturingStatus() [BBR] = 0</i> • Black Box Recorder feature disabled
Enable	<i>ManufacturingStatus() [BBR] = 0 AND 0x0025 to ManufacturerAccess()</i>	<ul style="list-style-type: none"> • <i>ManufacturingStatus() [BBR] = 1</i> • Black Box Recorder feature enabled

11.1.20 ManufacturerAccess() 0x0026 Fuse

This command enables/disables firmware fuse toggle function for ease of manufacturing.

Status	Condition	Action
Disable	<i>ManufacturingStatus() [FUSE] = 1 AND 0x0026 to ManufacturerAccess()</i>	<ul style="list-style-type: none"> • <i>ManufacturingStatus() [FUSE] = 0</i> • FUSE pin action disabled
Enable	<i>ManufacturingStatus() [FUSE] = 0 AND 0x0026 to ManufacturerAccess()</i>	<ul style="list-style-type: none"> • <i>ManufacturingStatus() [FUSE] = 1</i> • FUSE pin action enabled

11.1.21 ManufacturerAccess() 0x0027 LED Enable

This command enables/disables LED Display function for ease of manufacturing.

Status	Condition	Action
Disable	<i>ManufacturingStatus() [LED] = 1 AND 0x0027 to ManufacturerAccess()</i>	<ul style="list-style-type: none"> • <i>ManufacturingStatus() [LED] = 0</i> • LED Display action disabled
Enable	<i>ManufacturingStatus() [LED] = 0 AND 0x0027 to ManufacturerAccess()</i>	<ul style="list-style-type: none"> • <i>ManufacturingStatus() [LED] = 1</i> • LED Display action enabled

11.1.22 ManufacturerAccess() 0x0028 Lifetime Data Reset

This command resets Lifetime data in data flash for ease of manufacturing.

Status	Condition	Action
Reset	0x0028 to <i>ManufacturerAccess()</i>	Clear Lifetime Data in DF

11.1.23 ManufacturerAccess() 0x0029 Permanent Fail Data Reset

This command resets PF data in data flash for ease of manufacturing.

Status	Condition	Action
Reset	0x0029 to <i>ManufacturerAccess()</i>	Clear PF Data in DF

11.1.24 *ManufacturerAccess()* 0x002A Black Box Recorder Reset

This command resets the black box recorder data in data flash for ease of manufacturing.

Status	Condition	Action
Reset	0x002A to <i>ManufacturerAccess()</i>	Clear Black Box Recorder data in DF

11.1.25 *ManufacturerAccess()* 0x002B LED Toggle

This command activate/deactivate configured LEDs for ease of manufacturing testing.

Status	Condition	Action
Disable	<i>OperationStatus()</i> [LED] = 1 AND 0x002B to <i>ManufacturerAccess()</i>	<ul style="list-style-type: none"> • <i>OperationStatus()</i>[LED] = 0 • LED disabled
Enable	<i>OperationStatus()</i> [LED] = 0 AND 0x002B to <i>ManufacturerAccess()</i>	<ul style="list-style-type: none"> • <i>OperationStatus()</i>[LED] = 1 • LED enabled

11.1.26 *ManufacturerAccess()* 0x002C LED Display On

This command simulates low-high-low detection on the /DISP pin for ease of manufacturing testing.

Status	Condition	Action
Activate	0x002C to <i>ManufacturerAccess()</i>	Simulates low-high-low detection on the $\overline{\text{DISP}}$ pin

11.1.27 *ManufacturerAccess()* 0x002D CAL Mode

This command enables output of the raw ADC and CC data on *ManufacturerData()*.

Status	Condition	Action
Disable	<i>ManufacturingStatus()</i> [CAL] = 1 AND 0x002D to <i>ManufacturerAccess()</i>	<ul style="list-style-type: none"> • <i>ManufacturingStatus()</i>[CAL] = 0 • Disable output of ADC and CC raw data on <i>ManufacturerData()</i>
Enable	<i>ManufacturingStatus()</i> [CAL] = 0 AND 0x002D to <i>ManufacturerAccess()</i>	<ul style="list-style-type: none"> • <i>ManufacturingStatus()</i>[CAL] = 1 • Enable output of ADC and CC raw data on <i>ManufacturerData()</i>, controllable with 0xF081 and 0xF082 on <i>ManufacturerAccess()</i>

11.1.28 *ManufacturerAccess()* 0x0030 Seal Device

This command seals the device for the field, disabling certain SBS commands and access to DF.

Status	Condition	Action
Sealed	<i>OperationStatus()</i> [SEC1,SEC0] = 0,1 or 1,0 AND 0x0030 to <i>ManufacturerAccess()</i>	<ul style="list-style-type: none"> • <i>OperationStatus()</i>[SEC1,SEC0] = 1,1 • Certain SBS Commands not available, see SBS table for details.

11.1.29 *ManufacturerAccess()* 0x0031 UnSeal Device

This command unseals the device after valid SHA-1 authentication.

Status	Condition	Action
Initiate	<i>OperationStatus()</i> [SEC1,SEC0] = 1,1 AND 0x0031 to <i>ManufacturerAccess()</i>	<ul style="list-style-type: none"> • <i>OperationStatus()</i>[AUTH] = 1 • 160-bit random number message available at <i>ManufacturerInput()</i> in the format 0xAABBCCDDEEFFGGHHIIJJKLLMMNNOOPPQQRRSSTTT, where AA is LSB.
Unseal	Correct 160-bit HMAC digest computed with random number + Unseal Key written to <i>ManufacturerInput()</i> in the format 0xAABBCCDDEEFFGGHHIIJJKLLMMNNOOPP, where AA is LSB	<ul style="list-style-type: none"> • <i>OperationStatus()</i>[SEC1,SEC0] = 0,1 • <i>OperationStatus()</i>[AUTH] = 0 • Device unsealed after 250 ms, for available SBS commands in UNSEAL mode see SBS table.
Invalid	Incorrect 160-bit hash written to <i>ManufacturerInput()</i>	<ul style="list-style-type: none"> • wait time 250 ms • <i>OperationStatus()</i>[SEC1,SEC0] = 0,0 • <i>OperationStatus()</i>[AUTH] = 0

11.1.30 ManufacturerAccess() 0x0032 Full Access Device

This command enable Full Access to the device after valid SHA-1 authentication.

Status	Condition	Action
Initiate	<i>OperationStatus()</i> [SEC1,SEC0] = 1,1 or 1,0 AND 0x0032 to <i>ManufacturerAccess()</i>	<ul style="list-style-type: none"> • <i>OperationStatus()</i>[AUTH] = 1 • 160-bit random number message available at <i>ManufacturerInput()</i> in the format 0xAABBCCDDEEFFGGHHIIJJKLLMMNNOOPPQQRRSSTTT, where AA is LSB
Full Access	Correct 160-bit HMAC digest computed with random number + Full Access Key written to <i>ManufacturerInput()</i> in the format 0xAABBCCDDEEFFGGHHIIJJKLLMMNNOOPP, where AA is LSB	<ul style="list-style-type: none"> • <i>OperationStatus()</i>[SEC1,SEC0] = 1,1 • <i>OperationStatus()</i>[AUTH] = 0 • Device enables full access after 250 ms. For available SBS commands in FULL ACCESS mode, see the SBS table.
Invalid	Incorrect 160-bit hash written to <i>ManufacturerInput()</i>	<ul style="list-style-type: none"> • Wait time 250 ms • <i>OperationStatus()</i>[SEC1,SEC0] = 0,0 • <i>OperationStatus()</i>[AUTH] = 0

11.1.31 ManufacturerAccess() 0x0033 ROM Mode

This command enables the ROM mode for IF update.

Status	Condition	Action
ROM Mode	<i>OperationStatus()</i> [SEC1,SEC0] = 1,0 AND 0x0033 to <i>ManufacturerAccess()</i>	Device goes to ROM mode ready for update, use 0x08 to <i>ManufacturerAccess()</i> to return.

11.1.32 ManufacturerAccess() 0x0034 SHIP Mode

In SHIP mode, the device enters a low power mode with no voltage, current, and temperature measurements, FETs are turned off, and the MCU is in a halt state. The device will return to NORMAL mode on SBS communication detection.

Status	Condition	Action
Enable	0x0034 to <i>ManufacturerAccess()</i>	<i>OperationStatus()</i> [SHIPM] = 1
Activate	<i>Current()</i> < Power: Sleep Current AND No SBS communication for power: SHIP Mode Com Delay	<ul style="list-style-type: none"> • Turn off CHG FET, PCHG FET • Turn off DSG FET, if Settings:System Configuration[SHIPDSG] = 0 • No Voltage, Temperature or Current Measurements • No Gauging • MCU in halt state HFO turned off.

Status	Condition	Action
Exit	SBS communication to device	<ul style="list-style-type: none"> • <i>OperationStatus()[SHIPM]</i> = 0 • Return to NORMAL mode

11.1.33 *ManufacturerAccess() 0x0035 Unseal Key*

This command enters a new Unseal key into the device.

Status	Condition	Action
initiate	<i>OperationStatus()[SEC1,SEC0]</i> = 1,0 AND 0x0035 to <i>ManufacturerAccess()</i>	<ul style="list-style-type: none"> • <i>OperationStatus()[AUTH]</i> = 1 • 160-bit random number message available at <i>ManufacturerInput()</i> in the format 0xAABBCCDDEEFFGGHHIIJJKLLMMNNOOPP QRRRSSTTT, where AA is LSB
Enter Key	Correct 128-bit Key written to <i>ManufacturerInput()</i> in the format 0xAABBCCDDEEFFGGHHIIJJKLLMMNNOOPP, where AA is LSB	<ul style="list-style-type: none"> • Wait time 250 ms • <i>OperationStatus()[AUTH]</i> = 0 • Device returns 160-bit digest at <i>ManufacturerInput()</i> in the format 0xAABBCCDDEEFFGGHHIIJJKLLMMNNOOPP QRRRSSTTT, where AA is LSB. Digest was calculated using the random number + key. compare with own calculations check validity of key.

11.1.34 *ManufacturerAccess() 0x0036 Full Access Key*

This command enters a new Full Access key into the device.

Status	Condition	Action
initiate	<i>OperationStatus()[SEC1,SEC0]</i> = 1,0 AND 0x0036 to <i>ManufacturerAccess()</i>	<ul style="list-style-type: none"> • <i>OperationStatus()[AUTH]</i> = 1 • 160-bit random number available at <i>ManufacturerInput()</i>
Enter Key	Correct 128-bit Key written to <i>ManufacturerInput()</i> in the format 0xAABBCCDDEEFFGGHHIIJJKLLMMNNOOPP, where AA is LSB	<ul style="list-style-type: none"> • Wait time 250 ms • <i>OperationStatus()[AUTH]</i> = 0 • Device returns 160-bit digest at <i>ManufacturerInput()</i> in the format 0xAABBCCDDEEFFGGHHIIJJKLLMMNNOOPP QRRRSSTTT, where AA is LSB. Digest was calculated using the random number + key. compare with own calculations check validity of key.

11.1.35 *ManufacturerAccess() 0x0037 Authentication Key*

This command enters a new authentication key into the device.

Status	Condition	Action
Initiate	<i>OperationStatus()[SEC1,SEC0]</i> = 1,0 AND 0x0037 to <i>ManufacturerAccess()</i>	<ul style="list-style-type: none"> • <i>OperationStatus()[AUTH]</i> = 1 • 160-bit random number available at <i>ManufacturerInput()</i>

Status	Condition	Action
Enter Key	Correct 128-bit Key written to ManufacturerInput() in the format 0xAABBCCDDEEFFGGHHIIJJKLLMMNNOOPP, where AA is LSB.	<ul style="list-style-type: none"> Wait time 250 ms OperationStatus()[AUTH] = 0 Device returns 160-bit HMAC digest at ManufacturerInput() in the format 0xAABBCCDDEEFFGGHHIIJJKLLMMNNOOPPQRRSSTTT, where AA is LSB. The HMAC digest was calculated using the random number + key. Compare with own calculations check validity of key.

11.1.36 ManufacturerAccess() 0x0050 SafetyAlert

This command returns the SafetyAlert() flags on ManufacturerData().

Status	Condition	Action
Activate	0x0050 to ManufacturerAccess()	Output SafetyAlert() flags on ManufacturerData()

11.1.37 ManufacturerAccess() 0x0051 SafetyStatus

This command returns the SafetyStatus() flags on ManufacturerData().

Status	Condition	Action
Activate	0x0051 to ManufacturerAccess()	Output SafetyStatus() flags on ManufacturerData()

11.1.38 ManufacturerAccess() 0x0052 PFAAlert

This command returns the PFAAlert() flags on ManufacturerData().

Status	Condition	Action
Activate	0x0052 to ManufacturerAccess()	Output PFAAlert() flags on ManufacturerData()

11.1.39 ManufacturerAccess() 0x0053 PFStatus

This command returns the PFStatus() flags on ManufacturerData().

Status	Condition	Action
Activate	0x0053 to ManufacturerAccess()	Output PFStatus() flags on ManufacturerData()

11.1.40 ManufacturerAccess() 0x0054 OperationStatus

This command returns the OperationStatus() flags on ManufacturerData().

Status	Condition	Action
Activate	0x0054 to ManufacturerAccess()	Output OperationStatus() flags on ManufacturerData()

11.1.41 ManufacturerAccess() 0x0055 ChargingStatus

This command returns the ChargingStatus() flags on ManufacturerData().

Status	Condition	Action
Activate	0x0055 to ManufacturerAccess()	Output ChargingStatus() flags on ManufacturerData()

11.1.42 *ManufacturerAccess()* 0x0056 GaugingStatus

This command returns the *GaugingStatus()* flags on *ManufacturerData()*.

Status	Condition	Action
Activate	0x0056 to <i>ManufacturerAccess()</i>	Output <i>GaugingStatus()</i> flags on <i>ManufacturerData()</i>

11.1.43 *ManufacturerAccess()* 0x0057 ManufacturingStatus

This command returns the *ManufacturingStatus()* flags on *ManufacturerData()*.

Status	Condition	Action
Activate	0x0057 to <i>ManufacturerAccess()</i>	Output <i>ManufacturingStatus()</i> flags on <i>ManufacturerData()</i>

11.1.44 *ManufacturerAccess()* 0x0058 AFE Register

This command returns the *AFERegister()* values on *ManufacturerData()*.

Status	Condition	Action
Activate	0x0058 to <i>ManufacturerAccess()</i>	Output <i>AFERegister()</i> values on <i>ManufacturerData()</i>

11.1.45 *ManufacturerAccess()* 0x0060 Lifetime Data Block 1

This command returns the Lifetime data on *ManufacturerData()*.

Status	Condition	Action
Activate	0x0060 to <i>ManufacturerAccess()</i>	Output 32 bytes of lifetime data values on <i>ManufacturerData()</i>

11.1.46 *ManufacturerAccess()* 0x0061 Lifetime Data Block 2

This command returns the Lifetime data on *ManufacturerData()*.

Status	Condition	Action
Activate	0x0061 to <i>ManufacturerAccess()</i>	Output 27 bytes of lifetime data values on <i>ManufacturerData()</i>

11.1.47 *ManufacturerAccess()* 0x0062 Lifetime Data Block 3

This command returns the Lifetime data on *ManufacturerData()*.

Status	Condition	Action
Activate	0x0062 to <i>ManufacturerAccess()</i>	Output 12 bytes of lifetime data values on <i>ManufacturerData()</i>

11.1.48 *ManufacturerAccess()* 0x0070 ManufacturerInfo

This command returns *ManufacturerInfo* on *ManufacturerData()*.

Status	Condition	Action
Activate	0x0070 to <i>ManufacturerAccess()</i>	Output 32 bytes of <i>ManufacturerInfo</i> on <i>ManufacturerData()</i>

11.1.49 ManufacturerAccess() 0x0071 Voltages

This command returns the CellVoltage, PackVoltage, and BatVoltage on *ManufacturerData()*.

Status	Condition	Action
Activate	0x0071 to <i>ManufacturerAccess()</i>	Output 12 bytes of voltage data values on <i>ManufacturerData()</i>

11.1.50 ManufacturerAccess() 0x0072 Temperatures

This command returns the internal temp sensor, TS1, TS2, TS3, TS4, CellTemp and FETTemp on *ManufacturerData()*.

Status	Condition	Action
Activate	0x0072 to <i>ManufacturerAccess()</i>	Output 14 bytes of temperature data values on <i>ManufacturerData()</i>

11.1.51 ManufacturerAccess() 0x0073 ITSTATUS1

This command instructs the device to return Impedance Track related gauging information on *ManufacturerData()*.

Status	Condition	Action
Activate	0x0073 to <i>ManufacturerAccess()</i>	Output 30 bytes of IT data values on <i>ManufacturerData()</i>

11.1.52 ManufacturerAccess() 0x0074 ITSTATUS2

This command instructs the device to return Impedance Track related gauging information on *ManufacturerData()*.

Status	Condition	Action
Activate	0x0074 to <i>ManufacturerAccess()</i>	Output 10 bytes of IT data values on <i>ManufacturerData()</i>

11.1.53 ManufacturerAccess() 0xF080 Exit Calibration Output Mode

This command returns the data acquisition to NORMAL mode.

Status	Condition	Action
Activate	<i>ManufacturerData()</i> [CAL] = 1 AND 0xF080 to <i>ManufacturerAccess()</i>	Stop output of ADC or CC data on <i>ManufacturerData()</i> and return to NORMAL data acquisition mode

11.1.54 ManufacturerAccess() 0xF081 Output CC and ADC for Calibration

This command let the device output the raw values of Coulomb counter, CellVoltage1, CellVoltage2, CellVoltage3, CellVoltage4, TS1, TS2, TS3, TS4, Tint, PACK, and BAT as block on *ManufacturerData()* with updates every 250 ms for calibration purposes.

The format of each value 2's complement, MSB first.

Status	Condition	Action
Disable	<i>ManufacturingStatus()</i> [CAL] = 1 AND 0xF080 to <i>ManufacturerAccess()</i>	<ul style="list-style-type: none"> • <i>ManufacturingStatus()</i>[CAL] = 0 • Stop output of ADC and CC data on <i>ManufacturerData()</i> and return to NORMAL data acquisition mode

Status	Condition	Action
Enable	0xF081 to <i>ManufacturerAccess()</i>	<ul style="list-style-type: none"> • <i>ManufacturingStatus()</i>[CAL] = 1 • Outputs the raw CC and AD values on <i>ManufacturerData()</i> in the format of ZZYyaaAAAbbBBccCCddDDeeEEffFGgGGhhHHiiIjjJkKkIILL, where: <ul style="list-style-type: none"> – ZZ: rolling 8-bit counter, increments when values are refreshed – YY: status, 1 when MAC() = 0xF081, 2 when MAC()=0xF082 – AAaa: Coulomb counter – BBaa: CellVoltage1 – CCaa: CellVoltage2 – DDaa: CellVoltage3 – EEee: CellVoltage4 – FFff: Tint – GGgg: TS1 – HHhh: TS2 – Iiii: TS3 – JJJj: TS4 – KKKk: PackVoltage – LLLl: BatVoltage

11.1.55 *ManufacturerAccess()* 0xF082 Output Shorted CC AND ADC Offset for Calibration

This command let the device output the raw CC value on *ManufacturerData()*.

The format of each value 2's complement, MSB first.

Status	Condition	Action
Disable	<i>ManufacturingStatus()</i> [CAL] = 1 AND 0xF080 to <i>ManufacturerAccess()</i>	<ul style="list-style-type: none"> • <i>ManufacturingStatus()</i>[CAL] = 0 • Stop output of ADC and CC data on <i>ManufacturerData()</i> and return to NORMAL data acquisition mode
Enable	0xF082 to <i>ManufacturerAccess()</i>	<ul style="list-style-type: none"> • <i>ManufacturingStatus()</i>[CAL] = 1 • Outputs the raw CC and AD values on <i>ManufacturerData()</i> in the format of ZZYyaaAAAbbBBccCCddDDeeEEffFGgGGhhHHiiIjjJkKkIILL, where: <ul style="list-style-type: none"> • ZZ: rolling 8-bit counter, increments when values are refreshed • YY: status, 1 when MAC() = 0xF081, 2 when MAC()=0xF082 • AAaa: Coulomb counter • BBaa: CellVoltage1 • CCaa: CellVoltage2 • DDaa: CellVoltage3 • EEee: CellVoltage4 • FFff: Tint • GGgg: TS1 • HHhh: TS2 • Iiii: TS3 • JJJj: TS4 • KKKk: PackVoltage • LLLl: BatVoltage

11.1.56 *ManufacturerAccess()* 0x01yy DF Access Row Address

This command sets the DF row with address yy on *ManufacturerInfo()* for immediate read/write on *ManufacturingInfo()*.

Status	Condition	Action
Activate	0x01yy to <i>ManufacturerAccess()</i>	Prepare DF 32-byte row with address yy on <i>ManufacturerInfo()</i> for block read or write.

11.2 0x01 RemainingCapacityAlarm()

This read/write word function sets a low capacity alarm threshold.

SBS Cmd	Name	Access			Proto- col	Type	Min	Max	Unit	Note
		SE	US	FA						
0x01	Remaining CapacityAlarm()	R/W			Word	U2	0	65535	mAh	<i>BatteryMode()[CAPM] = 0</i>
									10 mWh	<i>BatteryMode()[CAPM] = 1</i>

11.3 0x02 RemainingTimeAlarm()

SBS Cmd	Name	Access			Protocol	Type	Min	Max	Unit	Note
		SE	US	FA						
0x02	Remaining TimeAlarm()	R/W			Word	U2	0	65535	min	

11.4 0x03 BatteryMode()

SBS Cmd	Name	Access			Protocol	Type	Min	Max	Note
		SE	US	FA					
0x03	BatteryMode()		R/W		Word	H2	0x0000	0xFFFF	Bit 0: ICC—Internal Charge Controller (R) 0 = Function not supported Bit 1: PBC—Primary Battery Support (R) 1 = Primary or Secondary Battery Support Bit 2: Reserved Bit 3: Reserved Bit 4: Reserved Bit 5: Reserved Bit 6: Reserved Bit 7: CF—Condition Flag 0 = Battery OK 1 = Conditioning cycle requested Bit 8: CCE—Charge Controller Enabled (R/W) 0 = Internal charge controller disabled
0x03	BatteryMode()		R/W		Word	H2	0x0000	0xFFFF	Bit 9: PB—Primary Battery (R/W) 0 = Battery operating in its secondary role (default) 1 = Battery operating in its primary role Bit 10: Reserved Bit 11: Reserved Bit 12: Reserved Bit 13: AM—Alarm Mode (R/W) 0 = Enable Alarm Warning broadcasts to host and smart battery charger 1 = Disable Alarm Warning broadcasts to host and smart battery charger Bit 14: CHGM—Charger Mode (R/W) 0 = Enable <i>ChargingVoltage()</i> and <i>ChargingCurrent()</i> broadcasts to host and smart battery charger 1 = Disable <i>ChargingVoltage()</i> and <i>ChargingCurrent()</i> broadcasts to host and smart battery charger Bit 15: CAPM—Capacity Mode (R/W) 0 = Report in mA or mAh (default) 1 = Report in 10 mW or 10 mWh

11.5 0x04 AtRate()

This read/write word function sets the value used in calculating **AtRateTimeToFull()** and **AtRateTimeToEmpty()**.

SBS Cmd	Name	Access			Protocol	Type	Min	Max	Unit	Note
		SE	US	FA						
0x04	AtRate()	R/W			Word	I2	-32768	32767	mA	<i>BatteryMode()</i> [CAPM] = 0
									10 mW	<i>BatteryMode()</i> [CAPM] = 1

11.6 0x05 AtRateToFull()

This word read function returns the remaining time to fully charge the battery stack.

SBS Cmd	Name	Access			Protocol	Type	Min	Max	Unit	Note
		SE	US	FA						
0x05	AtRateToFull()	R			Word	U2	0	65534	min	65535 indicates not being charged

11.7 0x06 AtRateToEmpty()

This word read function returns the remaining time to fully discharge the battery stack.

SBS Cmd	Name	Access			Protocol	Type	Min	Max	Unit	Note
		SE	US	FA						
0x06	AtRateToEmpty()	R			Word	U2	0	65534	min	65535 indicates not being charged

11.8 0x07 AtRateOK()

SBS Cmd	Name	Access			Protocol	Type	Min	Max	Unit	Note
		SE	US	FA						
0x07	AtRateOK()	R			Word					0 = not ok

11.9 0x08 Temperature()

SBS Cmd	Name	Access			Protocol	Type	Min	Max	Unit	Note
		SE	US	FA						
0x08	Temperature()	R			Word	U2	0	65535	0.1°K	

11.10 0x09 Voltage()

SBS Cmd	Name	Access			Protocol	Type	Min	Max	Unit	Note
		SE	US	FA						
0x09	Voltage()	R			Word	U2	0	65535	mV	

11.11 0x0A Current()

SBS Cmd	Name	Access			Protocol	Type	Min	Max	Unit	Note
		SE	US	FA						
0x0A	Current()	R			Word	I2	-32767	32768	mA	

11.12 0x0B AverageCurrent()

SBS Cmd	Name	Access			Protocol	Type	Min	Max	Unit	Note
		SE	US	FA						
0x0B	Current()	R			Word	I2	-32767	32768	mA	

11.13 0x0C MaxError()

This read word function returns an unsigned integer value of the expected margin of error, in %, in the state-of-charge calculation with a range of 1 to 100%.

SBS Cmd	Name	Access			Protocol	Type	Min	Max	Unit	Note
		SE	US	FA						
0x0C	MaxError()		R		Word	U2	0	100	%	

Status	Condition	Action
	Full device reset	MaxError() = 100%
	RA-table only updated	MaxError() = 5%
	QMax only updated	MaxError() = 3%
	RA-table and QMax updated	MaxError() = 1%
	Each CycleCount() increment after last valid Qmax update	MaxError() increment by 0.05%
	Configuration:Max Error Time Cycle Equivalent period passed since last valid QMax update	MaxError() increment by 0.05%

11.14 0x0D RelativeStateOfCharge()

This read word function returns the predicted remaining battery capacity as a percentage of FullChargeCapacity().

SBS Cmd	Name	Access			Protocol	Type	Min	Max	Unit	Note
		SE	US	FA						
0x0D	RelativeStateOfCharge()		R		Word	U2	0	100	%	

11.15 0x0E AbsoluteStateOfCharge()

SBS Cmd	Name	Access			Protocol	Type	Min	Max	Unit	Note
		SE	US	FA						
0x0E	AbsoluteStateOfCharge()		R		Word	U2	0	100	%	

11.16 0x0F RemainingCapacity()

SBS Cmd	Name	Access			Protocol	Type	Min	Max	Unit	Note
		SE	US	FA						
0x0F	RemainingCapacity()	R	R	R/W	Word	U2	0	65535	mAh	BatteryMode()[CAPM] = 0
									10 mWh	BatteryMode()[CAPM] = 1

11.17 0x10 FullChargeCapacity()

SBS Cmd	Name	Access			Protocol	Type	Min	Max	Unit	Note
		SE	US	FA						
0x10	FullChargeCapacity()	R	R	R/W	Word	U2	0	65535	mAh	BatteryMode()[CAPM] = 0
									10 mWh	BatteryMode()[CAPM] = 1

11.18 0x11 RunTimeToEmpty()

SBS Cmd	Name	Access			Protocol	Type	Min	Max	Unit	Note
		SE	US	FA						
0x11	RunTimeTo Empty()	R	R	R	Word	U2	0	65534	min	65535 = Not being discharged

11.19 0x12 AverageTimeToEmpty()

SBS Cmd	Name	Access			Protocol	Type	Min	Max	Unit	Note
		SE	US	FA						
0x12	AverageTime To Empty()	R	R	R	Word	U2	0	65534	min	65535 = Not being discharged

11.20 0x13 AverageTimeToFull()

SBS Cmd	Name	Access			Protocol	Type	Min	Max	Unit	Note
		SE	US	FA						
0x13	AverageTime ToFull()	R	R	R	Word	U2	0	65534	min	65535 = Not being discharged

11.21 0x14 ChargingCurrent()

SBS Cmd	Name	Access			Protocol	Type	Min	Max	Unit	Note
		SE	US	FA						
0x14	Charging Current()	R	R	R	Word	U2	0	65534	mA	65535 = request maximum current

11.22 0x15 ChargingVoltage()

SBS Cmd	Name	Access			Protocol	Type	Min	Max	Unit	Note
		SE	US	FA						
0x15	Charging Voltage()	R	R	R	Word	U2	0	65534	mV	65535 = request maximum voltage

11.23 0x16 BatteryStatus()

SBS Cmd	Name	Access			Protocol	Type	Min	Max	Note
		SE	US	FA					
0x16	BatteryStatus()	R	R	R	Word	H2			Bit 3:0: EC3,EC2,EC1,EC0 Error Code 0x0 = OK 0x1 = Busy 0x2 = Reserved Command 0x3 = Unsupported Command 0x4 = AccessDenied 0x5 = Overflow/Underflow 0x6 = BadSize 0x7 = UnknownError Bit 4: FD—Fully Discharged 0 = Battery ok 1 = Battery fully depleted Bit 5: FC—Fully Charged 0 = Battery not fully charged 01 = Battery fully charged Bit 6: DSG—Discharging 0 = Battery is charging. 1 = Battery is discharging. Bit 7: INIT—Initialization 0 = Inactive 1 = Active Bit 8: RTA—Remaining Time Alarm 0 = Inactive 1 = Active
0x16	BatteryStatus()	R	R	R	Word	H2			Bit 9: RCA—Remaining Capacity Alarm 0 = Inactive 1 = Active Bit 10: Reserved Undefined Bit 11: TDA—Terminate Discharge Alarm 0 = Inactive 1 = Active Bit 12: OTA—Overtemperature Alarm 0 = Inactive 1 = Active Bit 13: Reserved Undefined Bit 14: TCA—Terminate Charge Alarm 0 = Inactive 1 = Active Bit 15: OCA—Over Charged Alarm 0 = Inactive 1 = Active

11.24 0x17 CycleCount()

SBS Cmd	Name	Access			Protocol	Type	Min	Max	Unit	Note
		SE	US	FA						
0x17	CycleCount()	R	R	R	Word	U2	0	65534	cycles	65535 = 65535 or more cycles

11.25 0x18 DesignCapacity()

SBS Cmd	Name	Access			Protocol	Type	Min	Max	Unit	Note
		SE	US	FA						
0x18	DesignCapacity()	R	R	R	Word	U2	0	65535	mAh	<i>BatteryMode()[CAPM] = 0</i>
									10 mWh	<i>BatteryMode()[CAPM] = 1</i>

11.26 0x19 DesignVoltage()

SBS Cmd	Name	Access			Protocol	Type	Min	Max	Unit	Note
		SE	US	FA						
0x19	DesignVoltage()	R	R	R	Word	U2	0	65535	mV	

11.27 0x1A SpecificationInfo()

SBS Cmd	Name	Access			Protocol	Type	Min	Max	Note
		SE	US	FA					
0x1A	SpecificationInfo()	R	R	R	Word	H2	0x0000	0xFFFF	Bit 0,1,2,3: Revision Revision 0,0,0,1 = Version 1.0 and 1.1 (default) Bit 4,5,6,7: Version Version 0,0,0,1 = Version 1.0 0,0,1,1 = Version 1.1 0,0,1,1 = Version 1.1 with optional PEC support Bit 8,9,10,11: VScale Voltage Scale Factor 0,0,0,0 = Reported voltages scaled by 10E0 0,0,0,1 = Reported voltages scaled by 10E1 0,0,1,0 = Reported voltages scaled by 10E2 0,0,1,1 = Reported voltages scaled by 10E3 Bit 12,13,14,15: Current 0,0,0,0 = Reported currents and capacities scaled by 10E0 except <i>ChargingVoltage()</i> and <i>ChargingCurrent()</i> 0,0,0,1 = Reported currents and capacities scaled by 10E1 except <i>ChargingVoltage()</i> and <i>ChargingCurrent()</i> 0,0,1,0 = Reported currents and capacities scaled by 10E2 except <i>ChargingVoltage()</i> and <i>ChargingCurrent()</i> 0,0,1,1 = Reported currents and capacities scaled by 10E3 except <i>ChargingVoltage()</i> and <i>ChargingCurrent()</i>

11.28 0x1B ManufacturerDate()

SBS Cmd	Name	Access			Protocol	Type	Min	Max	Note
		SE	US	FA					
0x1B	ManufacturerDate()	R	R	R	Word				<i>ManufacturerDate()</i> value in the following format: Day + Month*32 + (Year-1980)*256

11.29 0x1C SerialNumber()

SBS Cmd	Name	Access			Protocol	Type	Min	Max	Unit	Note
		SE	US	FA						
0x1C	SerialNumber()	R	R	R	Word					

11.30 0x20 ManufacturerName()

SBS Cmd	Name	Access			Protocol	Type	Min	Max	Unit	Note
		SE	US	FA						
0x20	ManufacturerName()	R	R	R	Block	S21				

11.31 0x21 DeviceName()

SBS Cmd	Name	Access			Protocol	Type	Min	Max	Unit	Note
		SE	US	FA						
0x21	DeviceName()	R	R	R	Block	S21				

11.32 0x22 DeviceChemistry()

SBS Cmd	Name	Access			Protocol	Type	Min	Max	Unit	Note
		SE	US	FA						
0x22	DeviceChemistry()	R	R	R	Block	S4				

11.33 0x23 ManufacturerData()

SBS Cmd	Name	Access			Protocol	Type	Min	Max	Unit	Note
		SE	US	FA						
0x23	ManufacturerData()	R	R	R	Block					

11.34 0x2F Authentication() AND ManufacturerInput()

This read/write block function provides SHA-1 authentication in default mode. It is also used to enable data flash read/writes and provide authentication input for SEALED, UNSEALED, FULL ACCESS mode.

SBS Cmd	Name	Access			Protocol	Type	Min	Max	Unit	Note
		SE	US	FA						
0x2F	ManufacturerInput()	R/W	R/W	R/W	Block					

Status	Condition	Action
Authentication	No active <i>ManufacturerInput()</i> data waiting AND write 160-bit challenge to <i>ManufacturerInput()</i> in the format 0xAABBCCDDEEFFGGHHIIJJKLLMMNNO OPPQRRSSTT, where AA is LSB.	<ul style="list-style-type: none"> <i>OperationStatus()</i>[AUTH] = 1 Wait 250 ms <i>OperationStatus()</i>[AUTH] = 0 Device returns 160-bit digest at <i>ManufacturerInput()</i> in the format 0xAABBCCDDEEFFGGHHIIJJKLLMMNNOOPP QRRSSTTT, where AA is LSB, using the challenge + authentication key. Compare with own calculations to confirm validity of key.
ManufacturerInfo	Valid word sent to <i>ManufacturerAccess()</i>	Output block based on <i>ManufacturerAccess()</i> input for one time readout. Note: 0xF081 and 0xF082 on <i>ManufacturerAccess()</i> will be available for multi-read out until cleared with 0xF080.

11.35 0x3C–0x3F Cell Voltages()

SBS Cmd	Name	Access			Protocol	Type	Min	Max	Default	Unit	Note
		SE	US	FA							
0x3C	Cell 3 voltage	R	R	R	Word	I2	0	32767		mV	
0x3D	Cell 2 voltage	R	R	R	Word	I2	0	32767		mV	

SBS Cmd	Name	Access			Protocol	Type	Min	Max	Default	Unit	Note
		R	R	R							
0x3E	Cell 1 voltage	R	R	R	Word	I2	0	32767		mV	
0x3F	Cell 0 voltage	R	R	R	Word	I2	0	32767		mV	

11.36 0x50 SafetyAlert()

SBS Cmd	Name	Access			Protocol	Type	Min	Max	Note
		SE	US	FA					
0x50	SafetyAlert()	N/A	R	R	Block				Bit 0: CUV—Cell Undervoltage 0 = Inactive 1 = Detected Bit 1: COV—Cell Overvoltage 0 = Inactive 1 = Detected Bit 2: OCC1—Overcurrent in Charge 1st Tier 0 = Inactive 1 = Detected Bit 3: OCC2—Overcurrent in Charge 2nd Tier 0 = Inactive 1 = Detected Bit 4: OCD1—Overcurrent in Discharge 1st Tier 0 = Inactive 1 = Detected Bit 5: OCD2—Overcurrent in Discharge 2nd Tier 0 = Inactive 1 = Detected Bit 6: OLD—Overload in discharge 0 = Inactive 1 = Detected Bit 7: Reserved Bit 8: SCC—Short circuit in charge 0 = Inactive 1 = Detected Bit 9: Reserved Bit 10: SCD—Short circuit in discharge 0 = Inactive 1 = Detected Bit 11: Reserved Bit 12: OTC—Overtemperature in charge 0 = Inactive 1 = Detected Bit 13: OTD—Overtemperature in discharge 0 = Inactive 1 = Detected Bit 14: CUVC—I*R compensated CUV 0 = Inactive 1 = Detected Bit 15: Reserved

SBS Cmd	Name	Access			Proto- col	Type	Min	Max	Note
		SE	US	FA					
0x50	SafetyAlert()	N/A	R	R	Block			Bit 16: OTF—FET overtemperature 0 = Inactive 1 = Detected Bit 17: HWD—SBS Host watchdog timeout 0 = Inactive 1 = Detected Bit 18: PTO—Pre-charging timeout 0 = Inactive 1 = Detected Bit 19: PTOS—Pre-charging timeout suspend 0 = Inactive 1 = Detected Bit 20: CTO—Charging timeout 0 = Inactive 1 = Detected Bit 21: CTOS—Charging timeout suspend 0 = Inactive 1 = Detected Bit 22: OC—Overcharge 0 = Inactive 1 = Detected Bit 23: CHGC—Charging Current higher than requested 0 = Inactive 1 = Detected Bit 24: CHGV—Charging Voltage higher than requested 0 = Inactive 1 = Detected Bit 25: Reserved Bit 26: Reserved Bit 27: Reserved Bit 28: Reserved Bit 29: Reserved Bit 30: Reserved Bit 31: Reserved	

11.37 0x51 SafetyStatus()

SBS Cmd	Name	Access			Proto- col	Type	Min	Max	Note
		SE	US	FA					
0x51	SafetyStatus()	N/A	R	R	Block				Bit 0: CUV—Cell UnderVoltage 0 = Inactive 1 = Detected Bit 1: COV—Cell Overvoltage 0 = Inactive 1 = Detected Bit 2: OCC1—Overcurrent in Charge 1st Tier 0 = Inactive 1 = Detected Bit 3: OCC2—Overcurrent in Charge 2nd Tier 0 = Inactive 1 = Detected Bit 4: OCD1—Overcurrent in Discharge 1st Tier 0 = Inactive 1 = Detected Bit 5: OCD2—Overcurrent in Discharge 2nd Tier 0 = Inactive 1 = Detected Bit 6: OLD—Overload in discharge 0 = Inactive 1 = Detected Bit 7: OLDL—Overload in discharge latch 0 = Inactive 1 = Detected Bit 8: SCC—Short circuit in charge 0 = Inactive 1 = Detected Bit 9: SCCL—Short circuit in charge latch 0 = Inactive 1 = Detected Bit 10: SCD—Short circuit in discharge 0 = Inactive 1 = Detected Bit 11: SCDL—Short circuit in discharge latch 0 = Inactive 1 = Detected

SBS Cmd	Name	Access			Protocol	Type	Min	Max	Note
		SE	US	FA					
0x51	SafetyStatus()	N/A	R	R	Block				Bit 12: OTC—Overtemperature in charge 0 = Inactive 1 = Detected Bit 13: OTD—Overtemperature in discharge 0 = Inactive 1 = Detected Bit 14: CUVC—I*R compensated CUV 0 = Inactive 1 = Detected Bit 15: Reserved Bit 16: OTF—FET overtemperature 0 = Inactive 1 = Detected Bit 17: HWD—SBS Host watchdog timeout 0 = Inactive 1 = Detected Bit 18: PTO—Pre-charging timeout 0 = Inactive 1 = Detected Bit 19: Reserved Bit 20: CTO—Charging timeout 0 = Inactive 1 = Detected Bit 21: Reserved Bit 22: OC—Overcharge 0 = Inactive 1 = Detected Bit 23: CHGC—Charging Current higher than requested 0 = Inactive 1 = Detected Bit 24: CHGV—Charging Voltage higher than requested 0 = Inactive 1 = Detected Bit 25: Reserved Bit 26: Reserved Bit 27: Reserved Bit 28: Reserved Bit 29: Reserved Bit 30: Reserved Bit 31: Reserved

11.38 0x52 PFAAlert()

SBS Cmd	Name	Access			Proto- col	Type	Min	Max	Note
		SE	US	FA					
0x52	PFAAlert()	N/A	R	R	Block				Bit 0: CUV—Cell undervoltage 0 = Inactive 1 = Detected Bit 1: COV—Cell overvoltage 0 = Inactive 1 = Detected Bit 2: CUDEP—Copper deposition 0 = Inactive 1 = Detected Bit 3: Reserved Bit 4: OTCE—Overtemperature 0 = Inactive 1 = Detected Bit 5: Reserved Bit 6: OTF—Overtemperature FET 0 = Inactive 1 = Detected Bit 7: QIM—QMax Imbalance 0 = Inactive 1 = Detected Bit 8: CB—Cell balancing 0 = Inactive 1 = Detected Bit 9: IMP—Cell impedance 0 = Inactive 1 = Detected Bit 10: CD—Capacity Deterioration 0 = Inactive 1 = Detected Bit 11: VIMR—Voltage imbalance at Rest 0 = Inactive 1 = Detected Bit 12: VIMA—Voltage imbalance at Rest 0 = Inactive 1 = Detected Bit 13: Reserved Bit 14: Reserved Bit 15: Reserved

SBS Cmd	Name	Access			Proto- col	Type	Min	Max	Note
		SE	US	FA					
0x52	PFAAlert()	N/A	R	R	Block				Bit 16: CFETF—Charge FET 0 = Inactive 1 = Detected Bit 17: DFET—Discharge FET 0 = Inactive 1 = Detected Bit 18: TH—Thermistor 0 = Inactive 1 = Detected Bit 19: FUSE—Fuse 0 = Inactive 1 = Detected Bit 20: AFER—AFE Register 0 = N/A 1 = Detected Bit 21: AFEC—AFE Communication 0 = Inactive 1 = Detected Bit 22: 2LVL—FUSE input indicating fuse trigger by external 2nd level protection 0 = Inactive 1 = Detected Bit 23: Reserved Bit 24: Reserved Bit 25: OCECO—Open VCx 0 = N/A 1 = Detected Bit 26: Reserved Bit 27: Reserved Bit 28: Reserved Bit 29: Reserved Bit 30: Reserved Bit 31: Reserved

11.39 0x53 PFStatus()

SBS Cmd	Name	Access			Proto- col	Type	Min	Max	Note
		SE	US	FA					
0x53	PFStatus()	N/A	R	R	Block				Bit 0: CUV—Cell undervoltage 0 = Inactive 1 = Active Bit 1: COV—Cell overvoltage 0 = Inactive 1 = Active Bit 2: Reserved Bit 3: Reserved Bit 4: OTCE—Overtemperature 0 = Inactive 1 = Active Bit 5: Reserved Bit 6: OTF—Overtemperature FET 0 = Inactive 1 = Active Bit 7: QIM—QMax Imbalance 0 = Inactive 1 = Active Bit 8: CB—Cell balancing 0 = Inactive 1 = Active Bit 9: IMP—Cell impedance 0 = Inactive 1 = Active Bit 10: CD—Capacity Deterioration 0 = Inactive 1 = Active Bit 11: VIMR—Voltage imbalance at Rest 0 = Inactive 1 = Active Bit 12: VIMA—Voltage imbalance at Rest 0 = Inactive 1 = Active Bit 13: Reserved Bit 14: Reserved Bit 15: Reserved

SBS Cmd	Name	Access			Proto- col	Type	Min	Max	Note
		SE	US	FA					
0x53	PFStatus()	N/A	R	R	Block			Bit 16: CFETF—Charge FET 0 = Inactive 1 = Active Bit 17: DFET—Discharge FET 0 = Inactive 1 = Active Bit 18: TH—Thermistor 0 = Inactive 1 = Active Bit 19: FUSE—Fuse 0 = Inactive 1 = Active Bit 20: AFER—AFE Register 0 = N/A 1 = Active Bit 21: AFEC—AFE Communication 0 = Inactive 1 = Active Bit 22: 2LVL FUSE input indicating fuse trigger by external 2nd level protection 0 = Inactive 1 = Active Bit 23: PTC—PTC by AFE 0 = Inactive 1 = Active Bit 24: IFC—Instruction Flash Checksum 0 = N/A 1 = IF checksum failure Bit 25: OCECO—Open VCx 0 = N/A 1 = Active Bit 26: DFW—DF write failure 0 = N/A 1 = Active Bit 27: Reserved Bit 28: Reserved Bit 29: Reserved Bit 30: Reserved Bit 31: Reserved	

11.40 0x54 OperationStatus()

SBS Cmd	Name	Access			Protocol	Type	Min	Max	Note
		SE	US	FA					
0x54	Operation Status()	N/A	R	R	Block				Bit 0: PRES—PRES input state 0 = PRES pin high 1 = PRES pin low Detected Bit 1: DSG—DSG FET Status 0 = Disabled 1 = Enabled Bit 2: CHG—CHG FET Status 0 = Disabled 1 = Enabled Bit 3: PCHG—PCHG FET Status 0 = Disabled 1 = Enabled Bit 4: GPOD—GPOD FET Status 0 = Disabled 1 = Enabled Bit 5: FUSE—FUSE input 0 = FUSE pin low 1 = FUSE pin high Detected Bit 6: CB—Cell Balancing 0 = Inactive 1 = Active Bit 7: LED—LED Enable 0 = Inactive 1 = Active Bit 9:8: SEC1,SEC0—Security Mode0 0 = Reserved 1, 0 = Full Access 0, 1 = Unsealed 1,1 = Sealed
0x54	Operation Status()	N/A	R	R	Block				Bit 10: CAL—Cal Raw ADC/CC output active 0 = Inactive 1 = Active Bit 11: SS—SafetyStatus 0 = Inactive 1 = Active Bit 12: PF—Permanent Failure 0 = Inactive 1 = Active Bit 13: XDSG—Discharging Disabled 0 = Inactive 1 = Active Bit 14: XCHG—Charging Disabled 0 = Inactive 1 = Active Bit 15: SLEEP—Sleep condition met 0 = Disabled 1 = Enabled Bit 16: SDM—Shutdown activated by <i>ManufacturerAccess()</i> 0 = Inactive 1 = Active Bit 17: SHIPM—SHIP mode activated with <i>ManufacturerAccess()</i> 0 = Inactive 1 = Active Bit 18: AUTH—Authentication ongoing 0 = Inactive 1 = Active

SBS Cmd	Name	Access			Proto- col	Type	Min	Max	Note
		SE	US	FA					
0x54	Operation Status()	N/A	R	R	Block			Bit 19: AWD—AFE Watchdog failure 0 = Inactive 1 = Active Bit 20: FVS—Fast Voltage Sampling 0 = Inactive 1 = Active Bit 21: CALO—Raw ADC/CC offset output 0 = Inactive 1 = Active Bit 22: SDV—SHUTDOWN activated by voltage 0 = Inactive 1 = Active Bit 23: SLEEPM—SLEEP mode activated by <i>ManufacturerAccess()</i> 0 = Inactive 1 = Active Bit 24: INIT—Initialization after full reset, cleared when SBS data calculated and available 0 = Inactive 1 = Active Bit 25: SMBLCAL—CC auto offset calibration ongoing after SBS line goes low 0 = Inactive 1 = Active Bit 26: SLEEPQMax—QMax update in SLEEP mode 0 = Inactive 1 = Active Bit 27: SLEEPC—Checking current in SLEEP mode 0 = Inactive 1 = Active Bit 28: XLSBS Fast Mode 0 = Inactive 1 = Active Bit 29: Reserved Bit 30: Reserved Bit 31: Reserved	

11.41 0x55 ChargingStatus()

SBS Cmd	Name	Access			Protocol	Type	Min	Max	Note
		SE	US	FA					
0x55	Charging Status()		R	R	Block				Bit 0: UT—Under Temperature Range 0 = Inactive 1 = Active Bit 1: LT—Low Temperature Range 0 = Inactive 1 = Active Bit 2: STL—Standard Temperature Low Range 0 = Inactive 1 = Active Bit 3: RT—Recommended Temperature Range 0 = Inactive 1 = Active Bit 4: ST—Standard Temperature High Range 0 = Inactive 1 = Active Bit 5: HT—High Temperature Range 0 = Inactive 1 = Active Bit 6: OT—Over Temperature Range 0 = Inactive 1 = Active Bit 7: PV—Precharge Voltage Range 0 = Inactive 1 = Active Bit 8: LV—Low Voltage Range 0 = Inactive 1 = Active Bit 9: MV—Mid Voltage Range 0 = Inactive 1 = Active Bit 10: HV—High Voltage Range 0 = Inactive 1 = Active Bit 11: IN—Charge Inhibit 0 = Inactive 1 = Active Bit 12: SU—Charge Suspend 0 = Inactive 1 = Active Bit 13: CCR—ChargingCurrent() Rate 0 = Inactive 1 = Active Bit 14: CVR—ChargingVoltage() Rate 0 = Inactive 1 = Active Bit 15: CCC—ChargingCurrent() Compensation 0 = Inactive 1 = Active

11.42 0x56 GaugingStatus()

SBS Cmd	Name	Access			Proto- col	Type	Min	Max	Note
		SE	US	FA					
0x56	Gauging Status()		R	R	Block				Bit 0: RESTDOD0, OCV and QMax Updated 0 = Not updated 1 = Updated Bit 1: DSG—Discharge Detected 0 = Charging 1 = Discharging Bit 2: RU—Resistance update 0 = Disabled 1 = Enabled Bit 3: VOK Cell Voltage OK for QMax update 0 = Inactive 1 = Active Bit 4: QEN—QMax updates 0 = Disabled 1 = Enabled Bit 5: FD—Fully Discharged Detected by gauge algorithm 0 = Disabled 1 = Enabled Bit 6: FC—Fully Charged Detected by gauge algorithm 0 = Disabled 1 = Enabled Bit 7: NSFM—Negative scale factor mode 0 = Disabled 1 = Enabled Bit 8: VDQ—Discharge qualified for learning 0 = Disabled 1 = Enabled Bit 9: QMax—QMax updated. This flag toggles every time QMax is updated. Bit 10: RX—Resistance update. This flag toggles every time Resistance is updated. Bit 11: LDMD—Load Mode 0 = Constant current mode 1 = Constant power mode Bit 12: OCVFR—OCV in flat region 0 = OCV outside flat region 1 = OCV in flat region Bit 13: TDA—Terminate Discharge Alarm set by gauging algorithm 0 = Disabled 1 = Enabled Bit 14: TCA—Terminate Charge Alarm set by gauging algorithm 0 = Disabled 1 = Enabled Bit 15: LPF Relax—LiPh Relax Mode, only active with Chem ID 0x400 0 = Disabled 1 = Enabled

11.43 0x57 ManufacturingStatus()

The enable bits FET_EN, LF_EN, PF_EN, BBR_ENFUSE_EN, and LED_EN can be set in the golden image if packmaker does not want to send the individual enable commands. The only function that can not be enabled by setting DF Setting Manufacturing Status is IT Enable. The IT Enable cmd is needed to take DOD0 value for fast Qmax, and so on.

SBS Cmd	Name	Access			Proto- col	Type	Min	Max	Default	Note
		SE	US	FA						
0x57	Manufacturing Status()		R	R	Block				0x8000	Bit 0: PCHG—PCHG Function, only available with FET = 0 0 = Disabled 1 = Enabled Bit 1: CHG—CHG FET, only available with FET = 0 0 = Disabled 1 = Enabled Bit 2: DSG—DSG FET, only available with FET = 0 0 = Disabled 1 = Enabled Bit 3: GAUGE—Gauging 0 = Disabled 1 = Enabled (default) Bit 4: FET—FET action 0 = Disabled 1 = Enabled (default) Bit 5: LF—Lifetime data collection 0 = Disabled 1 = Enabled (default) Bit 6: PF—Permanent Fail 0 = Disabled 1 = Enabled (default) Bit 7: BBR—Black box recorder 0 = Disabled 1 = Enabled (default) Bit 8: FUSE—FUSE action 0 = Disabled 1 = Enabled (default) Bit 9: LED—LED Display 0 = Disabled 1 = Enabled (default) Bit 10: Reserved Bit 11: Reserved Bit 12: Reserved Bit 13: Reserved Bit 14: Reserved Bit 15: CAL ADC or CC output on <i>ManufacturerData()</i> 0 = Disabled 1 = Enabled (default)

11.44 0x58 AFERegisters()

SBS Cmd	Name	Access			Proto- col	Type	Min	Max	Note
		SE	US	FA					
0x58	AFERegisters()		R	R	Block				Output AFE register values on <i>ManufacturerData()</i> in the following format: AABCCDDEEFFGGHHIIJJKK where: <ul style="list-style-type: none"> • AA: STATUS register • BB: STATE_CONTROL register • CC: OUTPUT_CONTROL register • DD: OUTPUT_STATUS register • EE: FUNCTION_CONTROL register • FF: CELL_SEL register • GG: OCDV register • HH: OCDD register • II: SCC register • JJ: SCD1 register • KK: SCD2 register

11.45 0x60 Lifetime Data Block 1

SBS Cmd	Name	Access			Proto- col	Type	Min	Max	Note
		SE	US	FA					
0x60	Lifetime Data Block 1		R	R	Block				Output lifetimes values on <i>ManufacturerData()</i> in the following format: AABBCDDDEEFFGGHHIIJJKLLMMN NOOPPQQRRSSTTUUVVWWXXVZZ 112233445566 where: <ul style="list-style-type: none"> • in the following format: • AA: Max Cell Voltage 1 • BB: Max Cell Voltage 2 • CC: Max Cell Voltage 3 • DD: Max Cell Voltage 4 • EE: Min Cell Voltage 1 • FF: Min Cell Voltage 2 • GG: Min Cell Voltage 3 • HH: Min Cell Voltage 4 • II: Max Delta Cell Voltage • JJ: Max Charge Current • KK: Max Discharge Current • LL: Max Average Discharge Current • MM: Max Average Discharge Power • NN: No of COV Events • OO: Last COV Event • PP: No of CUV Events • QQ: Last CUV Event • RR: No of OCD1 Events • SS: Last OCD1 Event • TT: No of OCD2 Events • UU: Last OCD2 Event • VV: No of OCC1 Events • WW: Last OCC1 Event • XX: No of OCC2 Events • YY: Last OCC2 Event • ZZ: No of OLD Events • 11: Last OLD Event • 22: No of SCD Events • 33: Last SCD Event • 44: No of SCC Events • 55: Last SCC Event • 66: No of OTC Events

11.46 0x61 Lifetime Data Block 2

SBS Cmd	Name	Access			Protocol	Type	Min	Max	Default	Note
		SE	US	FA						
0x61	Lifetime Data Block 2		R	R	Block					Output lifetimes values on <i>ManufacturerData()</i> in the following format: <ul style="list-style-type: none"> • AABBCDDDEEFFGGHHIIJJKKL LMMNNOOPPQQRRSSTTUUVV WWXXVZZ11 where: • AA: Last OTC Event • BB: No of OTD Events • CC: Last OTD Event • DD: No of OTF Events • EE: Last OTF Event • FF: No Valid Charge Terminations • GG: Last Valid Charge Termination • HH: No of QMax Updates • II: Last QMax Update • JJ: No of RA Updates • KK: Last RA Update • LL: No of RA Disables • MM: Last RA Disable • NN: No of Shutdowns • OO: No of Partial Resets • PP: No of Full Resets • QQ: No of WDT Resets • RR: CB Time Cell 1 • SS: CB Time Cell 2 • TT: CB Time Cell 3 • UU: CB Time Cell 4 • VV: Max Temp Cell • WW: Min Temp Cell • XX: Max Delta Cell Temp • YY: Max Temp Int Sensor • ZZ: Min Temp Int Sensor • 11: Max Temp FET

11.47 0x62 Lifetime Data Block 3

SBS Cmd	Name	Access			Protocol	Type	Min	Max	Default	Note
		SE	US	FA						
0x62	Lifetime Data Block 3		R	R	Block					Output lifetimes values on <i>ManufacturerData()</i> <ul style="list-style-type: none"> • in the following format: aaAAbbBBccCCddDDeeEEffFFg gGGhhHH where: • AAaa: Total firmware Run Time • BBbb: Time Spent in UT • CCcc: Time Spent in LT • DDdd: Time Spent in STL *EEee: Time Spent in RT • FFff: Time Spent in STH • GGgg: Time Spent in HT • HHhh: Time Spent in OT

11.48 0x70 ManufacturerInfo()

SBS Cmd	Name	Access			Protocol	Type	Min	Max	Note
		SE	US	FA					
0x70	Manufacturer Info()	R	R/W	R/W	Block				Instruct the device to return 32 bytes of <i>ManufacturerInfo()</i> . Output 32 bytes of <i>ManufacturerInfo</i> on <i>ManufacturerData()</i> in the following format: AABBCCDDEEFFGGHHIIJKLLMMNN OOPPQQRRSSTTUUVVWWXXVZZ112 233445566

11.49 0x71 Voltages()

SBS Cmd	Name	Access			Protocol	Type	Min	Max	Note
		SE	US	FA					
0x71	Voltages()	N/A	R	R	Block				Output 12 bytes of voltage data values on <i>ManufacturerData()</i> in the following format: aaAAbbBBccCCddDDeeEEffFF where: <ul style="list-style-type: none"> • AAaa: Cell Voltage 0 • BBbb: Cell Voltage 1 • CCcc: Cell Voltage 2 • DDdd: Cell Voltage 3 • EEee: BAT Voltage • FFff: PACK Voltage

11.50 0x72 Temperatures()

SBS Cmd	Name	Access			Protocol	Type	Min	Max	Note
		SE	US	FA					
0x72	Temperatures()	N/A	R	R	Block				<ul style="list-style-type: none"> • Output 14 bytes of temperature data values on <i>ManufacturerData()</i> in the following format: aaAAbbBBccCCddDDeeEEffFF where: • AAaa: Int Temperature • BBbb: TS1 Temperature • CCcc: TS2 Temperature • DDdd: TS3 Temperature • EEee: TS4 Temperature • FFff: Cell Temperature • GGgg: FET Temperature

11.51 0x73 ITStatus1()

This read block function returns gauging algorithm related parameters.

SBS Cmd	Name	Access			Proto- col	Type	Min	Max	Note
		SE	US	FA					
0x73	ITStatus1()	N/A	R	R	Block				Output 30 bytes of IT data values on <i>ManufacturerData()</i> in the following format: aaAAbbBBccCCddDDeeEEffFFGGggH HhhIiiJjjkkKILLmmMMnnNNooOO where: <ul style="list-style-type: none"> • AAaa: DOD0 Cell 0 • BBbb: DOD0 Cell 1 • CCcc: DOD0 Cell 2 • DDdd: DOD0 Cell 3 • EEEe: Passed Charge since last DOD0 Update • FFff: QMax Cell 0 • GGgg: QMax Cell 1 • HHhh: QMax Cell 2 • Iiii: QMax Cell 3 • JJJjKkkk: State Time • LLll: DOD EOC Cell 0 • MMmm: DOD EOC Cell 1 • NNnn: DOD EOC Cell 2 • OOOo: DOD EOC Cell 3

Attribute	Description	Format
DOD0_0	Depth of discharge cell 0	I2
DOD0_1	Depth of discharge cell 1	I2
DOD0_2	Depth of discharge cell 2	I2
DOD0_3	Depth of discharge cell 3	I2
ChargeDOD0Update	Passed charge since last DOD0 update	I2
QMax0	Qmax of cell 0	I2
QMax1	Qmax of cell 1	I2
QMax2	Qmax of cell 2	I2
QMax3	Qmax of cell 3	I2
StateTime	Time passed since last state change (DSG,CHG,RST)	U4
DODEOC0	Depth of discharge cell at End of Charge cell 0	U2
DODEOC1	Depth of discharge cell at End of Charge cell 1	U2
DODEOC2	Depth of discharge cell at End of Charge cell 2	U2
DODEOC3	Depth of discharge cell at End of Charge cell 3	U2

11.52 0x74 ITStatus2()

This read block function returns gauging algorithm related parameters.

SBS Cmd	Name	Access			Proto- col	Type	Min	Max	Note
		SE	US	FA					
0x74	ITStatus2()		R	R	Block				Output 30 bytes of IT data values on <i>ManufacturerData()</i> in the following format: AABBCCDDEEFFggGGhhHHiiiJJkkKKILL mmMMnnNNooOOppPPqqQQRrRR where: <ul style="list-style-type: none"> • AA: Pack Grid point • BB: Learned Status • CC: Grid Cell 0 • DD: Grid Cell 1 • EE: Grid Cell 2 • FF: Grid Cell 3 • GGgg: CompRes Cell 0 • HHhh: CompRes Cell 1 • Iiii: CompRes Cell 2 • JJjj: CompRes Cell 3 • Kkkk: CB Time Cell 0 • LLll: CB Time Cell 1 • MMmm: CB Time Cell 2 • NNnn: CB Time Cell 3 • OOoo: RaScale0 • PPpp: RaScale1 • QQqq: RaScale2 • RRrr: RaScale3

Attribute	Description	Format
PackGrid	Active pack grid point (minimum of CellGrid0 to CellGrid3)	U1
LStatus	Learned status of resistance table	Bit 1,0: CF—QMax status 0,0 = Battery OK 0,1 = QMax is first updated in learning cycle 1,0 = QMax and resistance table updated in learning cycle Bit 2: ITEN—IT enable 0 = IT disabled 1 = IT Enabled Bit 3: ITEN—QMax update in Field 0 = QMax never updated in field 1 = Qmax updated in filed
CellGrid0	Active grid point cell 0	U1
CellGrid1	Active grid point cell 1	U1
CellGrid2	Active grid point cell 2	U1
CellGrid3	Active grid point cell 3	U1
CompRes0	Last calculated temperature compensated resistance cell 0	U2
CompRes1	Last calculated temperature compensated resistance cell 1	U2
CompRes2	Last calculated temperature compensated resistance cell 2	U2
CompRes3	Last calculated temperature compensated resistance cell 3	U2
CBTime0	Calculated cell balancing time cell 0	U2
CBTime1	Calculated cell balancing time cell 1	U2

Attribute	Description	Format
CBTime2	Calculated cell balancing time cell 2	U2
CBTime3	Calculated cell balancing time cell 3	U2
RaScale0	Ra Table scaling factor cell 0	U2
RaScale1	Ra Table scaling factor cell 1	U2
RaScale2	Ra Table scaling factor cell 2	U2
RaScale3	Ra Table scaling factor cell 3	U2

Data Flash Values and Device Configuration

12.1 Data Formats

12.1.1 Unsigned Integer

Unsigned integers are stored without changes as 1-byte, 2-byte or 4-byte values.

12.1.2 Integer

Integer values are stored in 2's-complement format in 1-byte, 2-byte, or 4-byte values.

12.1.3 Floating Point

Floating point are stored using 4 byte format, where the MSB is the exponent, byte 3 to 0 the mantissa in unsigned integer format, with the MSB in byte 3 as sign bit.

Where:

Exp: Exponent

Mantissa: 23 bit mantissa with 24 bit as sign bit.

The floating point value is represented as:

12.1.4 Hex

Bit register definitions are stored in unsigned integer format.

12.1.5 String

String values are stored with length byte first, followed by a number of data bytes defined with the length byte.

12.2 Protections

12.2.1 CUV—Cell Undervoltage

Class	Subclass	Name	Type	Min	Max	Default	Unit	Description
Protections	CUV	Threshold	I2	0	32767	2800	mV	Cell undervoltage trip threshold
Protections	CUV	Delay	U1	0	255	2	s	Cell undervoltage trip delay
Protections	CUV	Recovery	I2	0	32767	3000	mV	Cell undervoltage recovery threshold

12.2.2 CUVC—Cell Undervoltage Compensated

Class	Subclass	Name	Type	Min	Max	Default	Unit	Description
Protections	CUVC	Threshold	I2	0	32767	2900	mV	Cell undervoltage compensated trip threshold
Protections	CUVC	Delay	U1	0	255	2	s	Cell undervoltage compensated trip delay
Protections	CUVC	Recovery	I2	0	32767	3000	mV	Cell undervoltage compensated recovery threshold

12.2.3 COV—Cell Overvoltage

Class	Subclass	Name	Type	Min	Max	Default	Unit	Description
Protections	COV	Threshold Low Temp	I2	0	32767	4250	mV	Cell overvoltage low temperature range trip threshold
Protections	COV	Threshold Standard Temp	I2	0	32767	4250	mV	Cell overvoltage standard temperature range trip threshold
Protections	COV	Threshold High Temp	I2	0	32767	4250	mV	Cell overvoltage high temperature range trip threshold
Protections	COV	Threshold Rec Temp	I2	0	32767	4250	mV	Cell overvoltage recommended temperature range trip threshold
Protections	COV	Delay	U1	0	255	2	s	Cell overvoltage trip delay
Protections	COV	Recovery Low Temp	I2	0	32767	4150	mV	Cell overvoltage low temperature range recovery threshold
Protections	COV	Recovery Standard Temp	I2	0	32767	4150	mV	Cell overvoltage standard temperature recovery range threshold
Protections	COV	Recovery High Temp	I2	0	32767	4150	mV	Cell overvoltage high temperature range recovery threshold
Protections	COV	Recovery Rec Temp	I2	0	32767	4150	mV	Cell overvoltage recommended temperature range recovery threshold

12.2.4 OCC1—Overcurrent In Charge 1

Class	Subclass	Name	Type	Min	Max	Default	Unit	Description
Protections	OCC1	Threshold	I2	-32768	32767	6000	mA	Overcurrent in Charge 1 trip threshold
Protections	OCC1	Delay	U1	0	255	6	s	Overcurrent in Charge 1 trip delay

12.2.5 OCC2—Overcurrent In Charge 2

Class	Subclass	Name	Type	Min	Max	Default	Unit	Description
Protections	OCC2	Threshold	I2	-32768	32767	8000	mA	Overcurrent in Charge 2 trip threshold
Protections	OCC2	Delay	U1	0	255	3	s	Overcurrent in Charge 2 trip delay

12.2.6 OCC Overcurrent In Charge Recovery

Class	Subclass	Name	Type	Min	Max	Default	Unit	Description
Protections	OCC	Recovery Threshold	I2	-32768	32767	-50	mA	Overcurrent in Charge 1 and 2 recovery threshold
Protections	OCC	Recovery Delay	U1	0	255	5	s	Overcurrent in Charge 1 and 2 recovery delay

12.2.7 OCD1—Overcurrent In Discharge 1

Class	Subclass	Name	Type	Min	Max	Default	Unit	Description
Protections	OCD1	Threshold	I2	-32768	32767	-6000	mA	Overcurrent in Discharge 1 trip threshold
Protections	OCD1	Delay	U1	0	255	6	s	Overcurrent in Discharge 1 trip delay

12.2.8 OCD2—Overcurrent In Discharge 2

Class	Subclass	Name	Type	Min	Max	Default	Unit	Description
Protections	OCD2	Threshold	I2	-32768	32767	-8000	mA	Overcurrent in Discharge 2 trip threshold
Protections	OCD2	Delay	U1	0	255	3	s	Overcurrent in Discharge 2 trip delay

12.2.9 OCD—Overcurrent In Discharge Recovery

Class	Subclass	Name	Type	Min	Max	Default	Unit	Description
Protections	OCD	Recovery	I2	-32768	32767	50	mA	Overcurrent in Discharge 1 and 2 recovery threshold
Protections	OCD	Recovery Delay	U1	0	255	5	s	Overcurrent in Discharge 1 and 2 recovery delay

12.2.10 OLD—Overload in Discharge

Class	Subclass	Name	Type	Min	Max	Default	Unit	Description
Protections	OLD	Threshold	H1	0x00	0x0F	0x09	10 mV	Bit 3:0: Overload Trip Threshold between SRP and SRN Threshold can be set from 50 mV to 200 mV with 10 mV step. If Settings:AFE State Control[RSNS] = 1, threshold value will be divided in half. See Appendix A for details.
Protections	OLD	Delay	H1	0x00	0x0F	0x0F	2 ms	Bit 3:0: Overload Trip Delay Delay can be set from 1 ms to 31 s with 2-ms steps. See Appendix A for details.
Protections	OLD	Latch Limit	U1	0	255	0	counts	Overload latch counter trip threshold
Protections	OLD	Counter Dec Delay	U1	0	255	10	s	Overload latch counter decrement delay
Protections	OLD	Recovery	U1	0	255	5	s	Overload recovery time
Protections	OLD	Reset	U1	0	255	15	s	Overload latch reset time

12.2.11 SCC—Short Circuit In Charge

Class	Subclass	Name	Type	Min	Max	Default	Unit	Description
Protections	SCC	Threshold	H1	0x00	0xFF	0x77		Bit 2:0: Short Circuit in Charge Threshold—Threshold can be set from 100 mV to 300 mV in 50-mV steps. If Settings:AFE State Control[RSNS] = 1, Threshold value will be divided in half. Bit 3: Reserved Bit 7:4: Short Circuit in Charge Delay Time—Delay can be set from 0 μ s to 915 μ s in 61- μ s steps. See Appendix A for details.
Protections	SCC	Latch Limit	U1	0	255	0		Short Circuit in Charge Latch counter trip threshold
Protections	SCC	Counter Dec Delay	U1	0	255	10	s	Short Circuit in Charge counter decrement delay
Protections	SCC	Recovery	U1	0	255	5	s	Short Circuit in Charge recovery time
Protections	SCC	Reset	U1	0	255	15	s	Short Circuit in Charge latch reset time

12.2.12 SCD1—Short Circuit In Discharge 1

Class	Subclass	Name	Type	Min	Max	Default	Unit	Description
Protections	SDC1	Threshold	H1	0x00	0xFF	0x77		Bit 2:0: Short Circuit in Discharge1 Threshold—Threshold can be set from 100 mV to 300 mV in 50 mV step. If Settings:AFE State Control[RSNS] = 1, Threshold value will be divided in half. Bit 3: Reserved Bit 7:4: Short Circuit in Discharge1 Delay Time—Delay can be set from 0 μ s to 915 μ s in 61- μ s step. If Settings:AFE State Control[SCDDx2] = 1, Delay Time value will be doubled. See Appendix A for details.

12.2.13 SCD2—Short Circuit in Discharge 2

Class	Subclass	Name	Type	Min	Max	Default	Unit	Description
Protections	SDC2	Threshold	H1	0x00	0xFF	0xE7		Bit 2:0: Short Circuit in Discharge2 Threshold—Threshold can be set from 100 mV to 300 mV in 50mV step. If Settings:AFE State Control[RSNS] = 1, Threshold value will be divided in half. Bit 3: Reserved Bit 7:4: Short Circuit in Discharge2 Delay Time—Delay can be set from 0 μs to 458 μs in 30 μs step. If Settings:AFE State Control[SCDDx2] = 1, Delay Time value will be doubled. See Appendix A for details.

12.2.14 SCD—Short Circuit in Discharge

Class	Subclass	Name	Type	Min	Max	Default	Unit	Description
Protections	SCD	Latch Limit	U1	0	255	0		Short Circuit in Discharge Latch counter trip threshold
Protections	SCD	Counter Dec Delay	U1	0	255	10	s	Short Circuit in Discharge counter decrement delay
Protections	SCD	Recovery	U1	0	255	5	s	Short Circuit in Discharge recovery time
Protections	SCD	Reset	U1	0	255	15	s	Short Circuit in Discharge latch reset time

12.2.15 OTC—Over Temperature in Charge

Class	Subclass	Name	Type	Min	Max	Default	Unit	Description
Protections	OTC	Threshold	I2	−400	1500	550	0.1°C	Over Temperature in Charge trip threshold
Protections	OTC	Delay	U1	0	255	2	s	Over Temperature in Charge Cell trip delay
Protections	OTC	Recovery	I2	−400	1500	500	0.1°C	Over Temperature in Charge Cell recovery threshold

12.2.16 OTD—Over Temperature in Discharge

Class	Subclass	Name	Type	Min	Max	Default	Unit	Description
Protections	OTD	Threshold	I2	−400	1500	600	0.1°C	Over Temperature in Discharge trip threshold
Protections	OTD	Delay	U1	0	255	2	s	Over Temperature in Discharge trip delay
Protections	OTD	Recovery	I2	−400	1500	550	0.1°C	Over Temperature in Discharge recovery threshold

12.2.17 OTF—Over Temperature FET

Class	Subclass	Name	Type	Min	Max	Default	Unit	Description
Protections	OTF	Threshold	I2	-400	1500	800	0.1°C	Over Temperature FET trip threshold
Protections	OTF	Delay	U1	0	255	2	s	Over Temperature FET trip delay
Protections	OTF	Recovery	I2	-400	1500	650	0.1°C	Over Temperature FET recovery threshold

12.2.18 HWD—Host Watchdog

Class	Subclass	Name	Type	Min	Max	Default	Unit	Description
Protections	HWD	Delay	U1	0	255	10	s	SBS Host watchdog trip delay

12.2.19 PTO—Pre Charge Mode Time Out

Class	Subclass	Name	Type	Min	Max	Default	Unit	Description
Protections	PTO	Charge Threshold	I2	-32768	32767	2000	mA	Pre-Charge Timeout Current Threshold
Protections	PTO	Suspend Threshold	I2	-32768	32767	1800	mA	Pre-Charge Timeout Suspend Threshold
Protections	PTO	Delay	U2	0	65535	1800	s	Pre-Charge Timeout trip delay
Protections	PTO	Reset	I2	-32768	32767	2	mA	Pre-Charge Timeout Reset Threshold

12.2.20 CTO—Fast Charge Mode Time Out

Class	Subclass	Name	Type	Min	Max	Default	Unit	Description
Protections	PTO	Charge Threshold	I2	-32768	32767	2500	mA	Fast-Charge Timeout Current Threshold
Protections	PTO	Suspend Threshold	I2	-32768	32767	2000	mA	Fast-Charge Timeout Suspend Threshold
Protections	PTO	Delay	U2	0	65535	54000	s	Fast-Charge Timeout trip delay
Protections	PTO	Reset	I2	-32768	32767	2	mA	Fast-Charge Timeout Reset Threshold

12.2.21 OC—Over Charge

Class	Subclass	Name	Type	Min	Max	Default	Unit	Description
Protections	OC	Threshold	I2	-32768	32767	300	mAh	Overcharge trip threshold
Protections	OC	Recovery	I2	-32768	32767	2	mAh	Overcharge recovery threshold
Protections	OC	RSOC Recovery	U1	0	100	90	%	Overcharge RemainingStateOfCharge() recovery threshold

12.2.22 CHGV—Charging Voltage

Class	Subclass	Name	Type	Min	Max	Default	Unit	Description
Protections	CHGV	Threshold	I2	-32768	32767	500	mV	<i>ChargingVoltage()</i> delta trip threshold
Protections	CHGV	Delay	U1	0	255	30	s	<i>ChargingVoltage()</i> delta trip delay
Protections	CHGV	Recovery	I2	-32768	32767	-500	mV	<i>ChargingVoltage()</i> delta recovery threshold

12.2.23 CHGC—Charging Current

Class	Subclass	Name	Type	Min	Max	Default	Unit	Description
Protections	CHGC	Threshold	I2	-32768	32767	500	mA	<i>ChargingCurrent()</i> delta trip threshold
Protections	CHGC	Delay	U1	0	255	2	s	<i>ChargingCurrent()</i> delta trip delay
Protections	CHGC	Recovery	I2	-32768	32767	100	mA	<i>ChargingCurrent()</i> delta recovery threshold

12.3 Permanent Fail

12.3.1 CUV—Cell Undervoltage

Class	Subclass	Name	Type	Min	Max	Default	Unit	Description
Permanent Fail	CUV	Threshold	I2	0	32767	2500	mV	Cell Undervoltage trip threshold
Permanent Fail	CUV	Delay	U1	0	255	2	s	Cell Undervoltage trip delay

12.3.2 COV—Cell Overvoltage

Class	Subclass	Name	Type	Min	Max	Default	Unit	Description
Permanent Fail	COV	Threshold	I2	0	32767	4400	mV	Cell Overvoltage trip threshold
Permanent Fail	COV	Delay	U1	0	255	2	s	Cell Overvoltage trip delay

12.3.3 CUDEP—Copper Deposition

Class	Subclass	Name	Type	Min	Max	Default	Unit	Description
Permanent Fail	CUDEP	Threshold	I2	0	32767	2500	mV	Copper Deposition trip threshold
Permanent Fail	CUDEP	Delay	U1	0	255	2	s	Copper Deposition trip delay

12.3.4 OTCE—Over Temperature Cell

Class	Subclass	Name	Type	Min	Max	Default	Unit	Description
Permanent Fail	OTCE	Threshold	I2	-400	1500	650	0.1°C	Over Temperature Cell trip threshold
Permanent Fail	OTCE	Delay	U1	0	255	2	s	Over Temperature Cell trip delay

12.3.5 OTF—Over Temperature FET

Class	Subclass	Name	Type	Min	Max	Default	Unit	Description
Permanent Fail	OTF	Threshold	I2	-400	1500	1000	0.1°C	Over Temperature FET trip threshold
Permanent Fail	OTF	Delay	U1	0	255	2	s	Over Temperature FET trip delay

12.3.6 QIM—QMax Imbalance

Class	Subclass	Name	Type	Min	Max	Default	Unit	Description
Permanent Fail	QIM	Threshold	I2	0	32767	500	mAh	QMax Imbalance trip threshold
Permanent Fail	QIM	Delay	U1	0	255	2	updates	QMax Imbalance trip delay

12.3.7 CB—Cell Balance

Class	Subclass	Name	Type	Min	Max	Default	Unit	Description
Permanent Fail	CB	Max Threshold	I2	0	32767	120	2h	Cell Balance max trip threshold
Permanent Fail	CB	Delta Threshold	U1	0	32767	20	2h	Cell Balance cell delta trip threshold
Permanent Fail	CB	Delay	U1	0	255	2	cycles	Cell Balance trip delay

12.3.8 VIMR—Voltage Imbalance at Rest

Class	Subclass	Name	Type	Min	Max	Default	Unit	Description
Permanent Fail	VIMR	Check Voltage	I2	0	5000	3600	mV	Voltage Imbalance at Rest Check Voltage
Permanent Fail	VIMR	Check Current	I2	0	32767	10	mA	Voltage Imbalance at Rest Check Current
Permanent Fail	VIMR	Delta Threshold	I2	0	5000	200	mV	Voltage Imbalance at Rest trip threshold
Permanent Fail	VIMR	Delay	U1	0	255	2	s	Voltage Imbalance at Rest Check trip delay
Permanent Fail	VIMR	Duration	U2	0	65535	100	s	Voltage Imbalance at Rest Check Duration

12.3.9 VIMA—Voltage Imbalance Active

Class	Subclass	Name	Type	Min	Max	Default	Unit	Description
Permanent Fail	VIMA	Check Voltage	I2	0	5000	3600	mV	Voltage Imbalance active Check Voltage
Permanent Fail	VIMA	Check Current	I2	0	32767	10	mA	Voltage Imbalance active Check Current
Permanent Fail	VIMA	Delta Threshold	I2	0	5000	300	mV	Voltage Imbalance active trip threshold
Permanent Fail	VIMA	Delay	U1	0	255	2	s	Voltage Imbalance active Check trip delay

12.3.10 IMP—Impedance Imbalance

Class	Subclass	Name	Type	Min	Max	Default	Unit	Description
Permanent Fail	IMP	Delta Threshold	U1	0	32767	400	%	Impedance Imbalance delta threshold
Permanent Fail	IMP	Max Threshold	I2	0	32767	300	%	Impedance Imbalance max threshold
Permanent Fail	IMP	Delay	U1	0	255	2	RA updates	Impedance Imbalance trip delay

12.3.11 CD—Capacity Degradation

Class	Subclass	Name	Type	Min	Max	Default	Unit	Description
Permanent Fail	CD	Threshold	I2	0	32767	4200	mAh	Capacity Degradation threshold
Permanent Fail	CD	Delay	U1	0	255	2	cycles	Capacity Degradation trip delay

12.3.12 CFETF—CHG FET Failure

Class	Subclass	Name	Type	Min	Max	Default	Unit	Description
Permanent Fail	CFETF	OFF Threshold	I2	0	500	5	mA	CHG FET OFF current trip threshold
Permanent Fail	CFETF	Delay	U1	0	255	2	s	CHG FET OFF trip delay

12.3.13 DFET—DFET Failure

Class	Subclass	Name	Type	Min	Max	Default	Unit	Description
Permanent Fail	DFET	OFF Threshold	I2	-500	0	-5	mA	DSG FET OFF current trip threshold
Permanent Fail	DFET	Delay	U1	0	255	2	s	DSG FET OFF trip delay

12.3.14 TH—NTC Thermistor Failure

Class	Subclass	Name	Type	Min	Max	Default	Unit	Description
Permanent Fail	TH	ADC High Threshold	U2	0	65535	32752	A/D counts	Thermistor open fail raw ADC trip threshold
Permanent Fail	TH	ADC Low Threshold	U2	0	65535	15	A/D counts	Thermistor short fail raw ADC trip threshold
Permanent Fail	TH	ADC Delay	U1	0	255	10	s	Thermistor fail trip delay

12.3.15 FUSE—FUSE Failure

Class	Subclass	Name	Type	Min	Max	Default	Unit	Description
Permanent Fail	FUSE	Threshold	I2	0	255	5	mA	FUSE activation fail trip threshold
Permanent Fail	FUSE	Delay	U1	0	255	2	s	FUSE activation fail trip delay

12.3.16 AFER—AFE Register

Class	Subclass	Name	Type	Min	Max	Default	Unit	Description
Permanent Fail	AFER	Threshold	U1	0	255	100	counts	AFE Register comparison fail trip threshold
Permanent Fail	AFER	Delay Period	U1	0	255	2	s	AFE Register comparison fail trip delay
Permanent Fail	AFER	Compare Period	U1	0	255	3	s	AFE Register comparison compare period

12.3.17 AFEC—AFE Communication

Class	Subclass	Name	Type	Min	Max	Default	Unit	Description
Permanent Fail	AFEC	Threshold	U1	0	255	100	counts	AFE Communication fail trip threshold
Permanent Fail	AFEC	Delay Period	U1	0	255	5	s	AFE Communication fail trip delay

12.3.18 2LVL—2nd Level OV

Class	Subclass	Name	Type	Min	Max	Default	Unit	Description
Permanent Fail	2LVL	Threshold	U1	0	255	2	s	2nd Level Protector trip detection delay

12.3.19 OCECO—Open Cell Connection

Class	Subclass	Name	Type	Min	Max	Default	Unit	Description
Permanent Fail	OCECO	Threshold	U2	0	32767	5000	mV	Open Cell Tab Connection trip threshold
Permanent Fail	OCECO	Delay Period	U1	0	255	2	s	Open Cell Tab Connection trip delay

12.4 Advanced Charge Algorithm

12.4.1 Temperature Ranges

Class	Subclass	Name	Type	Min	Max	Default	Unit	Description
Advanced Charge Algorithms	Temperature Ranges	T1	I1	-128	127	0		T1 low temperature range lower limit
Advanced Charge Algorithms	Temperature Ranges	T2	I1	-128	127	12		T2 low temperature range to standard temperature range
Advanced Charge Algorithms	Temperature Ranges	T5	I1	-128	127	30		T5 recommended temperature range lower limit
Advanced Charge Algorithms	Temperature Ranges	T6	I1	-128	127	55		T6 recommended temperature range upper limit
Advanced Charge Algorithms	Temperature Ranges	T3	I1	-128	127	20		T3 standard temperature range to high temperature range
Advanced Charge Algorithms	Temperature Ranges	T4	I1	-128	127	25		T4 high temperature range upper limit
Advanced Charge Algorithms	Temperature Ranges	Hysteresis	I1	-128	127	0		Temperature Hysteresis, applied when temperature is decreasing

12.4.2 Low Temp Charging

Class	Subclass	Name	Type	Min	Max	Default	Unit	Description
Advanced Charge Algorithms	Low Temp Charging	Voltage	I2	0	32767	3000	mV	Low temperature range <i>ChargingVoltage()</i>
Advanced Charge Algorithms	Low Temp Charging	Current Low	I2	0	32767	132	mA	Low temperature range low voltage range <i>ChargingCurrent()</i>
Advanced Charge Algorithms	Low Temp Charging	Current Med	I2	0	32767	352	mA	Low temperature range medium voltage range <i>ChargingCurrent()</i>
Advanced Charge Algorithms	Low Temp Charging	Current High	I2	0	32767	264	mA	Low temperature range high voltage range <i>ChargingCurrent()</i>

12.4.3 Standard Temp Charging

Class	Subclass	Name	Type	Min	Max	Default	Unit	Description
Advanced Charge Algorithms	Standard Temp Charging	Voltage	I2	0	32767	4200	mV	Standard temperature range <i>ChargingVoltage()</i>
Advanced Charge Algorithms	Standard Temp Charging	Current Low	I2	0	32767	1980	mA	Standard temperature range low voltage range <i>ChargingCurrent()</i>
Advanced Charge Algorithms	Standard Temp Charging	Current Med	I2	0	32767	4004	mA	Standard temperature range medium voltage range <i>ChargingCurrent()</i>
Advanced Charge Algorithms	Standard Temp Charging	Current High	I2	0	32767	2992	mA	Standard temperature range high voltage range <i>ChargingCurrent()</i>

12.4.4 High Temp Charging

Class	Subclass	Name	Type	Min	Max	Default	Unit	Description
Advanced Charge Algorithms	High Temp Charging	Voltage	I2	0	32767	4000	mV	High temperature range <i>ChargingVoltage()</i>
Advanced Charge Algorithms	High Temp Charging	Current Low	I2	0	32767	1012	mA	High temperature range low voltage range <i>ChargingCurrent()</i>
Advanced Charge Algorithms	High Temp Charging	Current Med	I2	0	32767	1980	mA	High temperature range medium voltage range <i>ChargingCurrent()</i>
Advanced Charge Algorithms	High Temp Charging	Current High	I2	0	32767	1496	mA	High temperature range high voltage range <i>ChargingCurrent()</i>

12.4.5 REC Temp Charging

Class	Subclass	Name	Type	Min	Max	Default	Unit	Description
Advanced Charge Algorithms	Rec Temp Charging	Voltage	I2	0	32767	4100	mV	Recommended temperature range <i>ChargingVoltage()</i>
Advanced Charge Algorithms	Rec Temp Charging	Current Low	I2	0	32767	2508	mA	Recommended temperature range low voltage range <i>ChargingCurrent()</i>
Advanced Charge Algorithms	Rec Temp Charging	Current Med	I2	0	32767	4488	mA	Recommended temperature range medium voltage range <i>ChargingCurrent()</i>
Advanced Charge Algorithms	Rec Temp Charging	Current High	I2	0	32767	3520	mA	Recommended temperature range high voltage range <i>ChargingCurrent()</i>

12.4.6 PCHG

Class	Subclass	Name	Type	Min	Max	Default	Unit	Description
Advanced Charge Algorithms	PCHG	Current	I2	0	32767	88	mA	Pre-Charge <i>ChargingCurrent()</i>

12.4.7 MCHG

Class	Subclass	Name	Type	Min	Max	Default	Unit	Description
Advanced Charge Algorithms	MCHG	Current	I2	0	32767	44	mA	Maintenance <i>ChargingCurrent()</i>

12.4.8 Voltage Range

Class	Subclass	Name	Type	Min	Max	Default	Unit	Description
Advanced Charge Algorithms	Voltage Range	Charging Voltage Low	I2	0	32767	2500	mV	Pre-Charge Voltage range to Charging Voltage Low range
Advanced Charge Algorithms	Voltage Range	Charging Voltage Med	I2	0	32767	3600	mV	Charging Voltage Low range to Charging Voltage Med range
Advanced Charge Algorithms	Voltage Range	Charging Voltage High	I2	0	32767	4000	mV	Charging Voltage Med to Charging Voltage High range
Advanced Charge Algorithms	Voltage Range	Hysteresis	U1	0	255	0	mV	Charging Voltage Hysteresis applied when voltage is decreasing.

12.4.9 Termination Config

Class	Subclass	Name	Type	Min	Max	Default	Unit	Description
Advanced Charge Algorithms	Termination Config	Charge Term Taper Current	I2	0	32767	250	mA	Valid Charge Termination taper current qualifier threshold
Advanced Charge Algorithms	Termination Config	Charge Term Voltage	I2	0	32767	75	mV	Valid Charge Termination delta voltage qualifier, max cell based

12.4.10 Cell Balancing Config

Class	Subclass	Name	Type	Min	Max	Default	Unit	Description
Advanced Charge Algorithms	Cell Balancing Config	Balance Time per mAh cell 0	U2	0	65535	367	s/mAh	Required balance time per mAh, calculated based on external resistor value at VCx pins using following formula: $3600 \text{ mA} \cdot \text{s} / (\text{VCELL} / (\text{RVCX} + \text{RCB}) \times \text{DUTY}) / 100$ where: VCELL = average cell voltage (3.7 V) RVCX = resistor value in series to VCx input (100 Ω) RCB = cell balancing FET RDSON (150 Ω) DUTY = cell balancing duty cycle (66%)

Class	Subclass	Name	Type	Min	Max	Default	Unit	Description
Advanced Charge Algorithms	Cell Balancing Config	Balance Time per mAh cell 1-3	U2	0	65535	514	s/mAh	Required balance time per mAh, calculated based on external resistor value at VCx pins using following formula: $3600 \text{ mA} \cdot \text{s} / (\text{VCELL} / (2 \cdot \text{RVCX} + \text{RCB}) \times \text{DUTY}) / 1000$ where: VCELL = average cell voltage (3.7 V) RVCX = resistor value in series to VCx input (100 Ω) RCB = cell balancing FET RDSON (150 Ω) DUTY = cell balancing duty cycle (66%)
Advanced Charge Algorithms	Cell Balancing Config	Min Start Balance Delta	U1	0	255	3	mV	Minimum cell voltage delta to start cell balancing. This condition is checked in relaxation state and so it only applies if cell balancing at reset is enabled.
Advanced Charge Algorithms	Cell Balancing Config	Relax Balance Interval	U4	0	4294967295	18000	s	Minimum relax time after cell balancing stopped to enable balancing again. This parameter applies to cell balancing at reset only.
Advanced Charge Algorithms	Cell Balancing Config	Min RSOC for Balancing	U1	0	100	80	%	Minimum <i>RelativeStateOfCharge()</i> threshold for cell balancing. This condition is checked during relaxation and so it only applies if cell balancing at reset is enabled.

12.4.11 Charging Rate of Change

Class	Subclass	Name	Type	Min	Max	Default	Unit	Description
Advanced Charge Algorithms	Charging Rate of Change	Current Rate	U1	1	255	1	steps/s	Number of steps to add between any 2 <i>ChargingCurrent()</i> settings
Advanced Charge Algorithms	Charging Rate of Change	Voltage Rate	U1	1	255	1	steps/s	Number of steps to add between any 2 <i>ChargingVoltage()</i> settings

12.4.12 Charge Loss Compensation

Class	Subclass	Name	Type	Min	Max	Default	Unit	Description
Advanced Charge Algorithms	Charge Loss Compensation	CCC Current Threshold	I2	0	32767	3520	mA	Constant Current Charge mode <i>ChargingCurrent()</i> threshold to activate Charge Loss Compensation
Advanced Charge Algorithms	Charge Loss Compensation	CCC Voltage Threshold	I2	0	255	4200	mV	Constant Current Charge mode max <i>ChargingVoltage()</i> increase limit

12.5 System Data

12.5.1 Manufacturer Data

Class	Subclass	Name	Type	Min	Max	Unit	Description
System Data	Manufacturer Data	ManufacturerInfo	S33				<i>ManufacturerInfo()</i> value
System Data	Manufacturer Data	DF Checksum	U2	0	65535		Holding place for DF checksum, not modified or read by device, for reference only

12.6 SBS Configuration

12.6.1 Data

Class	Subclass	Name	Type	Min	Max	Default	Unit	Description
SBS Configuration	Data	Remaining Ah Cap. Alarm	I2	0	32767	300	mAh	<i>RemainingCapacityAlarm()</i> value in mAh
SBS Configuration	Data	Remaining Wh Cap. Alarm	I2	0	32767	432	10 mWh	<i>RemainingCapacityAlarm()</i> value in 10 mWh
SBS Configuration	Data	Remaining Time Alarm	U2	0	65535	10	min	<i>RemainingTimeAlarm()</i> value
SBS Configuration	Data	Initial Battery Mode	H2	0x0000	0xFFFF	0x81		<i>BatteryMode()</i> value Bit 0: ICC Internal_Charge_Controller 0 = Function not supported Bit 1: PBC Primary_Battery_Support 1 = Primary or Secondary Battery Support Bit 2: Reserved Bit 3: Reserved Bit 4: Reserved Bit 5: Reserved Bit 6: Reserved Bit 7: CF—Condition_Flag 0 = Battery OK 1 = Conditioning cycle requested Bit 8: CCE—Charge_Controller_Enabled (R/W) 0 = Internal charge controller disabled Bit 9: PB—Primary_Battery (R/W) 0 = Battery operating in its secondary role (default) 1 = Battery operating in its primary role Bit 10: Reserved Bit 11: Reserved Bit 12: Reserved Bit 13: AM—Alarm_Mode (R/W) 0 = Enable Alarm Warning broadcasts to host and smart battery charger 1 = Disable Alarm Warning broadcasts to host and smart battery charger Bit 14: CHGM—Charger_Mode (R/W) 0 = Enable <i>ChargingVoltage()</i> and <i>ChargingCurrent()</i> broadcasts to host and smart battery charger 1 = Disable <i>ChargingVoltage()</i> and <i>ChargingCurrent()</i> broadcasts to host and smart battery charger Bit 15: CAPM—Capacity_Mode (R/W) 0 = Report in mA or mAh (default) 1 = Report in 10 mW or 10 mWh
SBS Configuration	Data	Design Voltage	I2	0	32767	14400	mV	<i>DesignVoltage()</i> value
SBS Configuration	Data	Specification Information	H2	0x0000	0xFFFF	0x31		<i>SpecificationInfo()</i> value in the following format: Bit 0,1,2,3: Revision Revision 0,0,0,1 = Version 1.0 and 1.1 (default) Bit 4,5,6,7: Version Version 0,0,0,1 = Version 1.0 0,0,1,1 = Version 1.1 0,0,1,1 = Version 1.1 with optional PEC support Bit 8,9,10,11: VScale Voltage Scale Factor 0,0,0,0 = reported voltages scaled by 10E0 0,0,0,1 = reported voltages scaled by 10E1 0,0,1,0 = reported voltages scaled by 10E2 0,0,1,1 = reported voltages scaled by 10E3 Bit 12,13,14,15: IPScale Voltage Scale Factor 0,0,0,0 = reported currents and capacities scaled by 10E0 except <i>ChargingVoltage()</i> and <i>ChargingCurrent()</i> 0,0,0,1 = reported currents and capacities scaled by 10E1 except <i>ChargingVoltage()</i> and <i>ChargingCurrent()</i> 0,0,1,0 = reported currents and capacities scaled by 10E2 except <i>ChargingVoltage()</i> and <i>ChargingCurrent()</i> 0,0,1,1 = reported currents and capacities scaled by 10E3 except <i>ChargingVoltage()</i> and <i>ChargingCurrent()</i>
SBS Configuration	Data	Manufacturer Date	U2	0	65535			<i>ManufacturerDate()</i> value in the following format: Day + Month*32 + (Year-1980)*256
SBS Configuration	Data	Serial Number	H2	0x0000	0xFFFF			<i>SerialNumber()</i> value
SBS Configuration	Data	Cycle Count	U2	0	65535		cycles	<i>CycleCount()</i> value

Class	Subclass	Name	Type	Min	Max	Default	Unit	Description
SBS Configuration	Data	Cycle Count Percentage	U1	0	255	90	%	Accumulated discharge of $FullChargeCapacity() \times (Cycle\ Count\ Percentage)$ to increment $CycleCount()$
SBS Configuration	Data	Max Error Limit	U1	0	100	100	%	$MaxError()$ threshold to set $BatteryMode()[CF]$
SBS Configuration	Data	Design Capacity	I2	0	32767	4400	mAh	$DesignCapacity()$ value in mAh
SBS Configuration	Data	Design Capacity	I2	0	32767	6336	10 mWh	$DesignCapacity()$ value in 10 mWh
SBS Configuration	Data	Manufacturer Name	S21					$ManufacturerName()$ value
SBS Configuration	Data	Device Name	S21					$DeviceName()$ value
SBS Configuration	Data	Device Chemistry	S5					$DeviceChemistry()$ value

12.6.2 FD

Class	Subclass	Name	Type	Min	Max	Default	Unit	Description
SBS Configuration	FD	Set Voltage Threshold	I2	0	5000	3000	mV	$BatteryStatus()[FD]$ cell voltage set threshold
SBS Configuration	FD	Clear Voltage Threshold	I2	0	5000	3100	mV	$BatteryStatus()[FD]$ cell voltage clear threshold
SBS Configuration	FD	Set RSOC % Threshold	U1	0	100	0	%	$BatteryStatus()[FD]RemainingStateOfCharge()$ set threshold
SBS Configuration	FD	Clear RSOC % Threshold	U1	0	100	5	%	$BatteryStatus()[FD]RemainingStateOfCharge()$ clear threshold

12.6.3 FC

Class	Subclass	Name	Type	Min	Max	Default	Unit	Description
SBS Configuration	FC	Set Voltage Threshold	I2	0	5000	4200	mV	$BatteryStatus()[FC]$ cell voltage set threshold
SBS Configuration	FC	Clear Voltage Threshold	I2	0	5000	4100	mV	$BatteryStatus()[FC]$ cell voltage clear threshold
SBS Configuration	FC	Set RSOC % Threshold	U1	0	100	100	%	$BatteryStatus()[FC]RemainingStateOfCharge()$ set threshold
SBS Configuration	FC	Clear RSOC % Threshold	U1	0	100	95	%	$BatteryStatus()[FC] RemainingStateOfCharge()$ clear threshold

12.6.4 TDA

Per the Smart Battery Data Specification 1.1, TDA is only active while discharging.

Class	Subclass	Name	Type	Min	Max	Default	Unit	Description
SBS Configuration	TDA	Set Voltage Threshold	I2	0	5000	3200	mV	$BatteryStatus()[TDA]$ cell voltage set threshold
SBS Configuration	TDA	Clear Voltage Threshold	I2	0	5000	3300	mV	$BatteryStatus()[TDA]$ cell voltage clear threshold
SBS Configuration	TDA	Set RSOC % Threshold	U1	0	100	10	%	$BatteryStatus()[TDA] RemainingStateOfCharge()$ set threshold
SBS Configuration	TDA	Clear RSOC % Threshold	U1	0	100	15	%	$BatteryStatus()[TDA] RemainingStateOfCharge()$ clear threshold

12.6.5 TCA

Per the Smart Battery Data Specification 1.1, TCA is only active while charging.

Class	Subclass	Name	Type	Min	Max	Default	Unit	Description
SBS Configuration	TCA	Set Voltage Threshold	I2	0	5000	4200	mV	<i>BatteryStatus()[TCA]</i> cell voltage set threshold
SBS Configuration	TCA	Clear Voltage Threshold	I2	0	5000	4100	mV	<i>BatteryStatus()[TCA]</i> cell voltage clear threshold
SBS Configuration	TCA	Set RSOC % Threshold	U1	0	100	100	%	<i>BatteryStatus()[TCA] RemainingStateOfCharge()</i> set threshold
SBS Configuration	TCA	Clear RSOC % Threshold	U1	0	100	95	%	<i>BatteryStatus()[TCA] RemainingStateOfCharge()</i> clear threshold

12.6.6 Max Error

Class	Subclass	Name	Type	Min	Max	Default	Unit	Description
SBS Configuration	Max Error	Time Cycle Equivalent	U1	0	255	12	2h	After valid QMax update, each passed time period of Time Cycle Equivalent will increment of <i>MaxError()</i> by Cycle Delta. Time Cycle Equivalent is provided for packs which may not get frequent Qmax updates like stand-by batteries. Time Cycle Equivalent increments Max Error by 0.05% for every Time Cycle Equivalent time period following the last Qmax update.
SBS Configuration	Max Error	Cycle Delta	U1	0	255	5	0.01%	Each increment of <i>CycleCount()</i> after valid QMax update will increment of <i>MaxError()</i> by Cycle Delta

12.7 Lifetimes

12.7.1 Voltage

Class	Subclass	Name	Type	Min	Max	Default	Unit	Description
Lifetimes	Voltage	Max Voltage Cell 0	U1	0	255	0	20 mV	Maximum reported cell voltage 0
Lifetimes	Voltage	Max Voltage Cell 1	U1	0	255	0	20 mV	Maximum reported cell voltage 1
Lifetimes	Voltage	Max Voltage Cell 2	U1	0	255	0	20 mV	Maximum reported cell voltage 2
Lifetimes	Voltage	Max Voltage Cell 3	U1	0	255	0	20 mV	Maximum reported cell voltage 3
Lifetimes	Voltage	Min Voltage Cell 0	U1	0	255	255	20 mV	Minimum reported cell voltage 0
Lifetimes	Voltage	Min Voltage Cell 1	U1	0	255	255	20 mV	Minimum reported cell voltage 1
Lifetimes	Voltage	Min Voltage Cell 2	U1	0	255	255	20 mV	Minimum reported cell voltage 2
Lifetimes	Voltage	Min Voltage Cell 3	U1	0	255	255	20 mV	Minimum reported cell voltage 3
Lifetimes	Voltage	Max Delta Cell Voltage	U1	0	255	0	20 mV	Maximum reported delta between cell voltages 0 to 3

12.7.2 Current

Class	Subclass	Name	Type	Min	Max	Default	Unit	Description
Lifetimes	Current	Max Chg Current	U1	0	255	0	200 mA	Maximum reported <i>Current()</i> in charge direction
Lifetimes	Current	Max Dsg Current	U1	0	255	0	200 mA	Maximum reported <i>Current()</i> in discharge direction
Lifetimes	Current	Max Avg Dsg Current	U1	0	255	0	200 mA	Maximum reported <i>AverageCurrent()</i> in discharge direction
Lifetimes	Current	Max Avg Dsg Power	U1	0	255	0	W	Maximum reported Power in discharge direction

12.7.3 Safety Events

Class	Subclass	Name	Type	Min	Max	Default	Unit	Description
Lifetimes	Safety Events	No of COV Events	U1	0	255	0	8 events	Total number of <i>SafetyStatus()</i> [COV] events
Lifetimes	Safety Events	Last COV Event	U1	0	255	0	4 cycles	Last <i>SafetyStatus()</i> [COV] event in <i>CycleCount()</i> cycles
Lifetimes	Safety Events	No of CUV Events	U1	0	255	0	8 events	Total number of <i>SafetyStatus()</i> [CUV] events
Lifetimes	Safety Events	Last CUV Event	U1	0	255	0	4 cycles	Last <i>SafetyStatus()</i> [CUV] event in <i>CycleCount()</i> cycles
Lifetimes	Safety Events	No of OCD1 Events	U1	0	255	0	8 events	Total number of <i>SafetyStatus()</i> [OCD1] events
Lifetimes	Safety Events	Last OCD1 Event	U1	0	255	0	4 cycles	Last <i>SafetyStatus()</i> [OCD1] event in <i>CycleCount()</i> cycles
Lifetimes	Safety Events	No of OCD2 Events	U1	0	255	0	8 events	Total number of <i>SafetyStatus()</i> [OCD2] events
Lifetimes	Safety Events	Last OCD2 Event	U1	0	255	0	4 cycles	Last <i>SafetyStatus()</i> [OCD2] event in <i>CycleCount()</i> cycles
Lifetimes	Safety Events	No of OCC1 Events	U1	0	255	0	8 events	Total number of <i>SafetyStatus()</i> [OCC1] events
Lifetimes	Safety Events	Last OCC1 Event	U1	0	255	0	4 cycles	Last <i>SafetyStatus()</i> [OCC1] event in <i>CycleCount()</i> cycles
Lifetimes	Safety Events	No of OCC2 Events	U1	0	255	0	8 events	Total number of <i>SafetyStatus()</i> [OCC2] events
Lifetimes	Safety Events	Last OCC2 Event	U1	0	255	0	4 cycles	Last <i>SafetyStatus()</i> [OCC2] event in <i>CycleCount()</i> cycles
Lifetimes	Safety Events	No of OLD Events	U1	0	255	0	8 events	Total number of <i>SafetyStatus()</i> [OLD] events
Lifetimes	Safety Events	Last OLD Event	U1	0	255	0	4 cycles	Last <i>SafetyStatus()</i> [OLD] event in <i>CycleCount()</i> cycles
Lifetimes	Safety Events	No of SCD Events	U1	0	255	0	8 events	Total number of <i>SafetyStatus()</i> [SCD] events
Lifetimes	Safety Events	Last SCD Event	U1	0	255	0	4 cycles	Last <i>SafetyStatus()</i> [SCD] event in <i>CycleCount()</i> cycles
Lifetimes	Safety Events	No of SCC Events	U1	0	255	0	8 events	Total number of <i>SafetyStatus()</i> [SCC] events
Lifetimes	Safety Events	Last SCC Event	U1	0	255	0	4 cycles	Last <i>SafetyStatus()</i> [SCC] event in <i>CycleCount()</i> cycles
Lifetimes	Safety Events	No of OTC Events	U1	0	255	0	8 events	Total number of <i>SafetyStatus()</i> [OTC] events
Lifetimes	Safety Events	Last OTC Event	U1	0	255	0	4 cycles	Last <i>SafetyStatus()</i> [OTC] event in <i>CycleCount()</i> cycles
Lifetimes	Safety Events	No of OTD Events	U1	0	255	0	8 events	Total number of <i>SafetyStatus()</i> [OTD] events
Lifetimes	Safety Events	Last OTD Event	U1	0	255	0	4 cycles	Last <i>SafetyStatus()</i> [OTD] event in <i>CycleCount()</i> cycles
Lifetimes	Safety Events	No of OTF Events	U1	0	255	0	8 events	Total number of <i>SafetyStatus()</i> [OTF] events
Lifetimes	Safety Events	Last OTF Event	U1	0	255	0	4 cycles	Last <i>SafetyStatus()</i> [OTF] event in <i>CycleCount()</i> cycles

12.7.4 Charging Events

Class	Subclass	Name	Type	Min	Max	Default	Unit	Description
Lifetimes	Safety Events	No of Valid Charge Terminations	U1	0	255	0	8 events	Total number of valid charge termination events
Lifetimes	Safety Events	Last Valid Charge Termination	U1	0	255	0	4 cycles	Last valid charge termination in <i>CycleCount()</i> cycles

12.7.5 Gauging Events

Class	Subclass	Name	Type	Min	Max	Default	Unit	Description
Lifetimes	Gauging Events	No of QMax Updates	U1	0	255	0	8 events	Total number of <i>GaugingStatus()[QMax]</i> toggles
Lifetimes	Gauging Events	Last QMax Update	U1	0	255	0	4 cycles	Last <i>GaugingStatus()[QMax]</i> toggle in <i>CycleCount()</i> cycles
Lifetimes	Gauging Events	No of RA Updates	U1	0	255	0	8 events	Total number of <i>GaugingStatus()[RX]</i> toggles
Lifetimes	Gauging Events	Last RA Update	U1	0	255	0	4 cycles	Last <i>GaugingStatus()[RX]</i> toggle in <i>CycleCount()</i> cycles
Lifetimes	Gauging Events	No of RA Disable	U1	0	255	0	8 events	Total number of <i>GaugingStatus()[RU] = 1</i> events
Lifetimes	Gauging Events	Last RA Disable	U1	0	255	0	4 cycles	Last <i>GaugingStatus()[RU] = 1</i> events in <i>CycleCount()</i> cycles

12.7.6 Power Events

Class	Subclass	Name	Type	Min	Max	Default	Unit	Description
Lifetimes	Power Events	No of Shutdowns	U1	0	255	0	events	Total number of Shutdown events

12.7.7 Cell Balancing

Class	Subclass	Name	Type	Min	Max	Default	Unit	Description
Lifetimes	Cell Balancing	CB Time Cell 0	U1	0	255	0	2h	Total performed cell balancing bypass time cell 0
Lifetimes	Cell Balancing	CB Time Cell 1	U1	0	255	0	2h	Total performed cell balancing bypass time cell 1
Lifetimes	Cell Balancing	CB Time Cell 2	U1	0	255	0	2h	Total performed cell balancing bypass time cell 2
Lifetimes	Cell Balancing	CB Time Cell 3	U1	0	255	0	2h	Total performed cell balancing bypass time cell 3

12.7.8 Temperature

Class	Subclass	Name	Type	Min	Max	Default	Unit	Description
Lifetimes	Temperature	Max Temp Cell	I1	-128	127	-128	°C	Maximum reported cell temperature
Lifetimes	Temperature	Min Temp Cell	I1	-128	127	127	°C	Minimum reported cell temperature
Lifetimes	Temperature	Max Delta Temp Cell	I1	-128	127	0	°C	Maximum reported temperature delta for TSx inputs configured as cell temperature
Lifetimes	Temperature	Max Temp Int Sensor	I1	-128	127	-128	°C	Maximum reported internal temperature sensor temperature
Lifetimes	Temperature	Min Temp Int Sensor	I1	-128	127	127	°C	Minimum reported internal temperature sensor temperature
Lifetimes	Temperature	Max Temp FET	I1	-128	127	-128	°C	Maximum reported FET temperature

12.7.9 Time

Class	Subclass	Name	Type	Min	Max	Default	Unit	Description
Lifetimes	Time	Total firmware Runtime	U2	0	65535	0	2 h	Total firmware runtime between resets
Lifetimes	Time	Time Spent in UT	U2	0	65535	0	2 h	Total firmware runtime spent below T1

Class	Subclass	Name	Type	Min	Max	Default	Unit	Description
Lifetimes	Time	Time Spent in LT	U2	0	65535	0	2 h	Total firmware runtime spent between T1 and T2
Lifetimes	Time	Time Spent in STL	U2	0	65535	0	2 h	Total firmware runtime spent between T2 and T5
Lifetimes	Time	Time Spent in RT	U2	0	65535	0	2 h	Total firmware runtime spent between T5 and T6
Lifetimes	Time	Time Spent in STH	U2	0	65535	0	2h	Total firmware runtime spent between T6 and T3
Lifetimes	Time	Time Spent in HT	U2	0	65535	0	2 h	Total firmware runtime spent between T3 and T4
Lifetimes	Time	Time Spent in OT	U2	0	65535	0	2 h	Total firmware runtime spent above T6

12.8 Settings

12.8.1 Fuse

Class	Subclass	Name	Type	Min	Max	Default	Description
Settings	Fuse	Permanent Fail Fuse 0-15	H2	0x0000	0xFFFF	0	Bit 0: CUV—Cell undervoltage fuse activation 0 = Disabled 1 = Enabled (default) Bit 1: COV—Cell overvoltage fuse activation 0 = Disabled 1 = Enabled (default) Bit 2: Reserved Bit 3: Reserved Bit 4: PF_OTCE—Overtemperature fuse activation 0 = Disabled 1 = Enabled (default) Bit 5: Reserved Bit 6: OTF—Overtemperature FET fuse activation 0 = Disabled 1 = Enabled (default) Bit 7: QIM—QMax Imbalance fuse activation 0 = Disabled 1 = Enabled (default) Bit 8: CB—Cell balancing fuse activation 0 = Disabled 1 = Enabled (default) Bit 9: IMP—Cell impedance fuse activation 0 = Disabled 1 = Enabled (default) Bit 10: CD—Capacity Deterioration fuse activation 0 = Disabled 1 = Enabled (default) Bit 11: VIMR—Voltage imbalance at Rest fuse activation 0 = Disabled 1 = Enabled (default) Bit 12: VIMA—Voltage imbalance at Rest fuse activation 0 = Disabled 1 = Enabled (default) Bit 13: Reserved Bit 14: Reserved Bit 15: Reserved

Class	Subclass	Name	Type	Min	Max	Default	Description
Settings	Fuse	Permanent Fail Fuse 16–32	H2	0x0000	0xFFFF	0	Bit 0: CFETF—Charge FET 0 = Disabled 1 = Enabled (default) Bit 1: DFETF—Discharge FET 0 = Disabled 1 = Enabled (default) Bit 2: THERM—Thermistor 0 = Disabled 1 = Enabled (default) Bit 3: Reserved Bit 4: AFE_PAFE Register 0 = N/A 1 = Enabled (default) Bit 5: AFE_CAFE Communication 0 = Disabled 1 = Enabled (default) Bit 6: 2LVL—FUSE input indicating fuse trigger by external 2nd level protection 0 = Disabled 1 = Enabled (default) Bit 7: Reserved Bit 8: Reserved Bit 9: OCECO—Open VCx 0 = N/A 1 = Enabled (default) Bit 10: DFW—DF wear out 0 = N/A 1 = Enabled (default) Bit 11: Reserved Bit 12: Reserved Bit 13: Reserved Bit 14: Reserved Bit 15: Reserved
Settings	Fuse	Min Fuse Blow Voltage	I2	0	32767	8000	Minimum voltage required to attempt fuse blow, pack based, FET failures bypass this requirement to blow the fuse

12.8.2 Manufacturing

Class	Subclass	Name	Type	Min	Max	Default	Description
Settings	Manufacturing	Manufacturing Status	H2	0x0000	0xFFFF	0x8000	Bit 0: PCHG_EN—PCHG Function, only available with FET = 0 0 = Disabled 1 = Enabled Bit 1: CHG_EN—CHG FET, only available with FET = 0 0 = Disabled 1 = Enabled Bit 2: DSG_ENDSG FET, only available with FET = 0 0 = Disabled 1 = Enabled Bit 3: GAUGE_EN—Gauging 0 = Disabled 1 = Enabled (default) Bit 4: FET_EN—FET action 0 = Disabled 1 = Enabled (default) Bit 5: LF_EN—Lifetime data collection 0 = Disabled 1 = Enabled (default) Bit 6: PF_EN—Permanent Fail 0 = Disabled 1 = Enabled (default) Bit 7: BBR_EN—Black box recorder 0 = Disabled 1 = Enabled (default) Bit 8: FUSE_EN—FUSE action 0 = Disabled 1 = Enabled (default) Bit 9: LED_EN—LED Display 0 = Disabled 1 = Enabled (default) Bit 10: Reserved Bit 11: Reserved Bit 12: Reserved Bit 13: Reserved Bit 14: Reserved Bit 15: CAL_EN—ADC or CC output on <i>ManufacturerData()</i> 0 = Disabled 1 = Enabled (default)

12.8.3 Protection

Class	Subclass	Name	Type	Min	Max	Default	Description
Settings	Protection	Enabled Protections 0–15	H2	0x0000	0xFFFF	0xFFFF	Bit 0: CUV—Cell Undervoltage 0 = Disabled 1 = Enabled (default) Bit 1: COV—Cell Overvoltage 0 = Disabled 1 = Enabled (default) Bit 2: OCC1—Overcurrent in Charge 1st Tier 0 = Disabled 1 = Enabled (default) Bit 3: OCC2—Overcurrent in Charge 2nd Tier 0 = Disabled 1 = Enabled (default) Bit 4: OCD1—Overcurrent in Discharge 1st Tier 0 = Disabled 1 = Enabled (default) Bit 5: OCD2—Overcurrent in Discharge 2nd Tier 0 = Disabled 1 = Enabled (default) Bit 6: AOLD—Overload in Discharge 0 = Disabled 1 = Enabled (default) Bit 7: AOLDL—Overload in Discharge latch 0 = Disabled 1 = Enabled (default) Bit 8: ASCC—Short circuit in charge 0 = Disabled 1 = Enabled (default) Bit 9: ASCCL—Short circuit in charge latch 0 = Disabled 1 = Enabled (default) Bit 10: ASCD—Short circuit in discharge 0 = Disabled 1 = Enabled (default) Bit 11: ASCDL—Short circuit in discharge latch 0 = Disabled 1 = Enabled (default) Bit 12: OTC—Overtemperature in charge 0 = Disabled 1 = Enabled (default) Bit 13: OTD—Overtemperature in discharge 0 = Disabled 1 = Enabled (default) Bit 14: CUVC—I ² R compensated CUV 0 = Disabled 1 = Enabled (default) Bit 15: Reserved
Settings	Fuse	Enabled Protections 16–32	H2	0x0000	0xFFFF	0xFFFF	Bit 0: OTF—FET overtemperature 0 = Disabled 1 = Enabled (default) Bit 1: HWDF—SBS Host watchdog timeout 0 = Disabled 1 = Enabled (default) Bit 2: PTO—Pre-charging timeout 0 = Disabled 1 = Enabled (default) Bit 3: PTOS—Pre-charging timeout suspend 0 = Disabled 1 = Enabled (default) Bit 4: CTO—Charging timeout 0 = Disabled 1 = Enabled (default) Bit 5: CTOS—Charging timeout suspend 0 = Disabled 1 = Enabled (default) Bit 6: OC—Overcharge 0 = Disabled 1 = Enabled (default) Bit 7: CHGC— <i>ChargingCurrent()</i> higher than requested 0 = Disabled 1 = Enabled (default) Bit 8: CHGV— <i>ChargingVoltage()</i> higher than requested 0 = Disabled 1 = Enabled (default) Bit 9: Reserved Bit 10: Reserved Bit 11: Reserved Bit 12: Reserved Bit 13: Reserved Bit 14: Reserved Bit 15: Reserved

12.8.4 Permanent Failure

Class	Subclass	Name	Type	Min	Max	Default	Description
Settings	Permanent Failure	Enabled PF 0–15	H2	0x0000	0xFFFF	0xFFFF	Bit 0: CUV—Cell undervoltage 0 = Disabled 1 = Enabled (default) Bit 1: COV—Cell overvoltage 0 = Disabled 1 = Enabled (default) Bit 2: CUDEP—Copper Deposition 0 = Disabled 1 = Enabled (default) Bit 3: Reserved Bit 4: PF_OTCE—Overtemperature 0 = Disabled 1 = Enabled (default) Bit 5: Reserved Bit 6: OTF—Overtemperature FET 0 = Disabled 1 = Enabled (default) Bit 7: QIM—QMax Imbalance 0 = Disabled 1 = Enabled (default) Bit 8: CB—Cell balancing 0 = Disabled 1 = Enabled (default) Bit 9: IMP—Cell impedance 0 = Disabled 1 = Enabled (default) Bit 10: CD—Capacity Degradation 0 = Disabled 1 = Enabled (default) Bit 11: VIMR—Voltage imbalance at Rest 0 = Disabled 1 = Enabled (default) Bit 12: VIMA—Voltage imbalance at Rest 0 = Disabled 1 = Enabled (default) Bit 13: Reserved Bit 14: Reserved Bit 15: Reserved
Settings	Permanent Failure	Enabled PF 16–32	H2	0x0000	0xFFFF	0xFFFF	Bit 0: CFETF—Charge FET 0 = Disabled 1 = Enabled (default) Bit 1: DFET—Discharge FET 0 = Disabled 1 = Enabled (default) Bit 2: TH—Thermistor 0 = Disabled 1 = Enabled (default) Bit 3: FUSE—Fuse 0 = Disabled 1 = Enabled (default) Bit 4: AFER—AFE Register 0 = N/A 1 = Enabled (default) Bit 5: AFEC—AFE Communication 0 = Disabled 1 = Enabled (default) Bit 6: 2LVL—FUSE input indicating fuse trigger by external 2nd level protection 0 = Disabled 1 = Enabled (default) Bit 7: Reserved Bit 8: Reserved Bit 9: OCECO—Open VCx 0 = N/A 1 = Enabled (default) Bit 10: DFW—DF wearout 0 = N/A 1 = Enabled (default) Bit 11: Reserved Bit 12: Reserved Bit 13: Reserved Bit 14: Reserved Bit 15: Reserved

12.8.5 Configuration

12.8.5.1 Protection Configuration

Class	Subclass	Name	Type	Min	Max	Default	Description
Settings	Configuration	Protection Configuration	H1	0x00	0xFF	0x01	Bit 0: Reserved Bit 1: CUV_RECOV_CHG require charge current to recover CUV and CUVC 0 = disable 1 = enable Bit 2: Reserved Bit 3: Reserved Bit 4: Reserved Bit 5: Reserved Bit 6: Reserved Bit 7: Reserved

12.8.5.2 Temperature Configuration

Class	Subclass	Name	Type	Min	Max	Default	Description
Settings	Configuration	Temperature Configuration	H2	0x0000	0xFFFF	0x0087	Bit 0: Internal TS enable—Internal 0 = Disable internal TS (default) 1 = Enable internal TS Bit 1: TS1 enable—TS1 0 = Disable TS1 1 = Enable TS1 (default) Bit 2: TS2 enable—TS2 0 = Disable TS2 1 = Enable TS2 (default) Bit 3: TS3 enable—TS3 0 = Disable TS3 (default) 1 = Enable TS3 Bit 4: TS4 enable—TS4 0 = Disable TS4 (default) 1 = Enable TS4 Bit 5: Internal TS Mode—Cell temp or FET temp 0 = Cell temp (default) 1 = FET temp Bit 6: TS1 Mode—Cell temp or FET temp 0 = Cell temp (default) 1 = FET temp Bit 7: TS2 Mode—Cell temp or FET temp 0 = Cell temp 1 = FET temp (default) Bit 8: TS3 Mode—Cell temp or FET temp 0 = Cell temp (default) 1 = FET temp Bit 9: TS4 Mode—Cell temp or FET temp 0 = Cell temp (default) 1 = FET temp Bit 10: CTEMP—Cell Temperature protection source 0 = MAX (default) 1 = Average Bit 11: FTEMP—FET Temperature protection source 0 = Max (default) 1 = Average Bit 12: OTFET—Overtemperature FET action 0 = FET action (default) 1 = FET action disabled Bit 13: Reserved Bit 14: Reserved Bit 15: Reserved

12.8.5.3 LED Configuration

Class	Subclass	Name	Type	Min	Max	Default	Description
Settings	Configuration	LED Configuration	H2	0x0000	0xFFFF	0x00D0	Bit 0: LEDR—LED display activation at device reset 0 = LED display not activated (default) 1 = LED display activated Bit 1: LEDRCA—Flashing of LED display when [RCA] is set 0 = LED display does not flash (default) 1 = LED display does flash Bit 2: LEDCHG—LED display during charging 0 = LED display not active (default) 1 = LED display active Bit 3: LEDMODE—LED display capacity selector 0 = Display RSOC (default) 1 = Display ASOC/DC Bit 5,4: LEDPF1, LEDPF0—LED Display PF Error Code 0,0 = PF Error code not available 0,1 = PF Error code shown after SOC if DISP is held low for LED Hold Time (default). 1,0 = PF Error code not available 1,1 = PF Error code shown after SOC Bit 7,6: LEDC1, LEDC0—LED Sink Current 0,0 = no limit 0,1 = 3 mA 1,0 = 4 mA 1,1 = 5 mA (default) Bit 8: Reserved Bit 9: Reserved Bit 10: Reserved Bit 11: Reserved Bit 12: Reserved Bit 13: Reserved Bit 14: Reserved Bit 15: Reserved

12.8.5.4 Charging Configuration

Class	Subclass	Name	Type	Min	Max	Default	Description
Settings	Configuration	Charging Configuration	H	0x00	0xFF	0	Bit 1, 0: PCHG1, PCHG0 Precharge method 0, 0 = Internal Precharge FET (not a valid option for bq30z55-R1) 0, 1 = CHG FET (default) 1, 0 = GPOD pin 1, 1 = Precharge disabled Bit 2: CRATE—ChargeCurrent rate 0 = $ChargeCurrent() \%C$ calculation based on $DesignCapacity()$ (default) 1 = $ChargeCurrent() \%C$ calculation based on $FullChargeCapacity()$ Bit 3: CHGSU—FET action in CHARGE SUSPEND mode 0 = FET active (default) 1 = Charging and Precharging disabled, FETs off Bit 4: CHGIN—FET action in CHARGE INHIBIT mode 0 = FET active (default) 1 = Charging and Precharging disabled, FETs off Bit 5: CHGFET—FET action on terminate charge alarm (TCA) 0 = FET active (default) 1 = Charging and Precharging disabled, FET off Bit 6: CCC—Constant Current Mode Loss Compensation 0 = Disabled (default) 1 = $ChargingVoltage()$ and $ChargingCurrent()$ values are compensated for voltage drop Bit 7: Reserved

12.8.5.5 System Configuration

Class	Subclass	Name	Type	Min	Max	Default	Description
Settings	Configuration	System Configuration	H2	0x0000	0xFFFF	0x0032	Bit 1,0: CC1, CC0 Cell Count 0,0 = Reserved 0,1 = 2 cell 1,0 = 3 cell 1,1 = 4 cell (default) Bit 2: NR Use PRES in system detection. 0 = Use PRES, removable mode (default). 1 = Non-removable mode Bit 3: SLEEPCHG—CHG FET enabled during sleep 0 = CHG FET off during sleep (default) 1 = CHG FET remains on during sleep Bit 4: SLEEP—SLEEP mode 0 = Disable SLEEP mode 1 = Enable SLEEP mode (default) Bit 5: CB—Cell balancing 0 = Disabled cell balancing 1 = Enable cell balancing (default) Bit 6: CBM—Cell balancing method 0 = Internal cell balancing (default) 1 = External cell balancing Bit 7: CBR—Cell balancing at rest 0 = Disable cell balancing at rest (default) 1 = Enable cell balancing at rest Bit 8: SHIPDSG—DSG FET enabled during SHIP mode 0 = Disable DSG FET at SHIP mode (default) 1 = Enable DSG FET at SHIP Mode Bit 9: Reserved Bit 10: Reserved Bit 11: Reserved Bit 12: Reserved Bit 13: Reserved Bit 14: Reserved Bit 15: Reserved

12.8.5.6 Gauging Configuration

Class	Subclass	Name	Type	Min	Max	Default	Description
Settings	Configuration	Gauging Configuration	H2	0x00	0xFF	0x1FDA	<p>Bit 0: CCT—Cycle count threshold 0 = Use CC % of <i>DesignCapacity()</i> (default) 1 = Use CC % of <i>FullChargeCapacity()</i></p> <p>Bit 1: CSYNC Sync <i>RemainingCapacity()</i> with <i>FullChargeCapacity()</i> at valid charge termination 0 = <i>RemainingCapacity()</i> is not synchronized. 1 = <i>RemainingCapacity()</i> is synchronized (default).</p> <p>Bit 2: RSOCL—<i>RelativeStateOfCharge()</i> and <i>RemainingCapacity()</i> behavior at end of charge 0 = Actual value shown (default) 1 = Held at 99% until valid charge termination. On entering valid charge termination update to 100%</p> <p>Bit 3: RESCAP—Reserve capacity calculation method 0 = light load 1 = use Load Select (default)</p> <p>Bit 4: LOCK0—Keep <i>RemainingCapacity()</i> and <i>RelativeStateOfCharge()</i> jumping back during relaxation after 0 and FD are reached during discharge. 0 = Disabled (default) 1 = Enabled</p> <p>Bit 5: SMOOTH— Run <i>RemainingCapacity()</i> through a low-pass filter to smooth out jumps at grid point updates, charge termination, and self-discharge adjustments made in relax mode. Smoothing is bypassed at the end of discharge when EDV is reached. Run <i>FullCapacity()</i> through a low-pass filter to smooth out jumps at charge termination and adjustments made in relax mode. Sample settings and associated low-pass filter time constants are in Table C-1. This smoothing feature uses the following formula updated every 1 second. $xfilter_k = \alpha \cdot xfilter_k + (1 - \alpha) \cdot xadc_k$ where: <i>xfilter_k</i>: the new filtered value <i>xfilter_k-1</i>: the previously calculated filter value <i>xadc_k</i>: the actual sample value α: filter constant As such, some lag may be observed between charge/discharge current and <i>RemainingCapacity()</i> changes. The SMOOTH function introduces some delays in IT simulation. It could mask out the <i>ReservedCapacity</i> setting if the capacity setting value is too small. If <i>ReservedCapacity</i> is desired, the user should consider using lower filter time, or increase the <i>ReservedCapacity</i> setting as compensation. The additional amount to compensate can be calculated as follows: $\text{Additional ReservedCap(mAH)} = \text{AverageLoadCurrent(mA)} \times \text{SmoothFilterSetting(sec)} / 3600$ 0 = Disabled (default) 1 = Enabled</p> <p>Bit 6: OCVFR—OCV look up disabled in flat region during charge until charged above flat region. Enabled again after Min Relax Time after Charge 0 = Disabled 1 = Enabled (default)</p> <p>Bit 7: DOD0EW—DOD0 error weighting, calculates new DOD0 values from the newly read value and the previous value using their respective errors. DOD0 readings have an associated error based on elapsed time since reading, conditions at time of reading (reset, charge termination, and so on), temperature, amount of relaxation at time of reading, and so on. The feature provides more accurate DOD0 points. It was introduced in the bq20z45 device. 0 = Disabled 1 = Enabled (default)</p>
Settings	Configuration	Gauging Configuration	H2	0x00	0xFF	0x1FDA	<p>Bit 8: LFP_RELAX, LiFePO4 chemistry has a unique slow relaxation near full charge. Detailed, in-house test data suggests that the relaxation after a full charge takes a few days to settle. The slow decaying voltage causes RSOC to continue to drop every 5 hours. Depending on the full charge taper current, the fully settled voltage could be close to or even below <i>FlatVoltMax</i> in some cases. For chemID 4xx (LiFePO4) series, the condition to exit the long relax mode is: the pack had previously charged to full or near full state, and then either a significant long relaxation or a non-trivial discharge has happened, such that when in relaxation, the $OCV < FlatVoltMax$.</p> <p>With the above, <i>Qmax</i> update is disabled because <i>dod</i> will not be taken as long as it is in <i>LFP_relax</i> mode. By the time the gas gauge exits the <i>LFP_relax</i> mode, the OCV is already in the flat zone. So <i>Qmax</i> update takes an alternative approach: Once full charge occurs (FC bit set), <i>dod0=Dod_at_EOC</i> is automatically assigned and valid for <i>Qmax</i> update; <i>VOK</i> is set if there is no <i>Qmax</i> update, or if <i>Qmax</i> is updated, <i>VOK</i> is cleared. The <i>dod</i> error as a result of this action is zero or negligible because in the LiFePO4 table, OCV voltage corresponding to <i>dod=0</i> is much lower. If <i>LFP_RELAX</i> is set, the firmware automatically enables the feature upon detecting that the chemistry is 4xx series. If clear, the feature is disabled. Lithium Iron Phosphate Relax 0 = Disabled (default) 1 = Enabled</p>

Class	Subclass	Name	Type	Min	Max	Default	Description
Settings	Configuration	Gauging Configuration	H2	0x00	0xFF	0x1FDA	<p>Bit 9: RSOC_CONV, addresses the convergence of RemCap to 0 at low temperatures and very high rates which may not be satisfactory because of the high granularity of resistance grids. If termination voltage is reached in DOD region with 10% grid interval or at the moment where voltage/SOC dependency is flat, error can be large. Fast resistance scaling will apply a scale factor to resistance in RemCap simulations leading up to 0. This scale factor is computed from actively measured resistance during the discharge. This measured resistance is an active number and may not be used for an Ra update.</p> <p>RSOC, fast resistance scaling 0 = Disabled 1 = Enabled (default)</p> <p>Bit 10: FAST_QMax_LRN, Fast Qmax learning: eliminates previously required relaxation periods, to use enable IT with perfectly relaxed cells ~50% RSOC (37% minimum), discharge to empty, Qmax will be learned when discharge stops. Fast QMax learning, during discharge when update status is 6. Update status will change to 11 if fast learning is successful. 0 = Disabled 1 = Enabled (default)</p> <p>Bit 11: Reserved</p> <p>Bit 12: RSOC_HOLD, prevents RSOC rise during discharge. RSOC will be held until calculated value falls below actual state. 0 = Disabled (default) 1 = Enabled</p> <p>Bit 13: CUV_TERM, CUV discharge termination: Remaining Capacity and Full Capacity calculations to accommodate reaching 0% RSOC before reaching CUV. This is helpful when the cells are out of balance. 0 = Disabled 1 = Enabled (default)</p> <p>Bit 14: Reserved Bit 15: Reserved</p>

12.8.5.7 SBS Configuration

Class	Subclass	Name	Type	Min	Max	Default	Description
Settings	Configuration	SBS Configuration	H1	0x00	0xFF	0x20	<p>Bit 0: BCAST—Enable alert and charging broadcast from device to host 0 = Disabled (default) 1 = Enabled</p> <p>Bit 1: CPE—PEC on charger broadcast 0 = Disabled (default) 1 = Enabled</p> <p>Bit 2: HPE—PEC on host communication 0 = Disabled (default) 1 = Enabled</p> <p>Bit 3: XL Enable 400 kHz com mode 0 = Normal SBS bus speed (default) 1 = 400 kHz bus speed</p> <p>Bit 5,4: BLT1, BLT0—Bus low timeout 0,0 = no SBS bus low timeout 0,1 = 1-s SBS bus low timeout 1,0 = 2-s SBS bus low timeout (default) 1,1 = 3-s SBS bus low timeout</p> <p>Bit 6: Reserved Bit 7: Reserved</p>

Class	Subclass	Name	Type	Min	Max	Default	Description
Settings	Configuration	SBS Data Config 0–15	H2	0x0000	0xFFFF	0x0CAF	Bit 0: TDASETV—Enable TDA flag set by cell voltage threshold 0 = Disabled 1 = Enabled (default) Bit 1: TDACLEARV—Enable TDA flag clear by cell voltage threshold 0 = Disabled 1 = Enabled (default) Bit 2: TDASETRSOC—Enable TDA flag set by RSOC threshold 0 = Disabled 1 = Enabled (default) Bit 3: TDACLEARRSOC—Enable TDA flag clear by RSOC threshold 0 = Disabled 1 = Enabled (default) Bit 4: TCASETV—Enable TCA flag set by cell voltage threshold 0 = Disabled 1 = Enabled (default) Bit 5: TCACLEARV—Enable TCA flag clear by cell voltage threshold 0 = Disabled 1 = Enabled (default) Bit 6: TCASETRSOC—Enable TCA flag set by RSOC threshold 0 = Disabled 1 = Enabled (default) Bit 7: TCACLEARRSOC—Enable TCA flag clear by RSOC threshold 0 = Disabled 1 = Enabled (default) Bit 8: TCACLEARCT—Enable TCA flag clear valid charge termination 0 = Disabled 1 = Enabled (default) Bit 9: FCCLEARCT—Enable FC flag clear by valid charge termination 0 = Disabled 1 = Enabled (default) Bit 10: FCSETVCT enable FC flag set on valid charge termination 0 = Disabled 1 = Enabled (default) Bit 11: TCASETVCT enable TCA flag set on valid charge termination 0 = Disabled 1 = Enabled (default) Bit 12: Reserved Bit 13: Reserved Bit 14: Reserved Bit 15: Reserved
		SBS Data Config 16–32	H1	0x00	0xFF	0xFF	Bit 0: FDSETV—Enable FD flag set by cell voltage threshold 0 = Disabled 1 = Enabled (default) Bit 1: FDCLEARV—Enable FD flag clear by cell voltage threshold 0 = Disabled 1 = Enabled (default) Bit 2: FDSETRSOC—Enable FD flag set by RSOC threshold 0 = Disabled 1 = Enabled (default) Bit 3: FDCLEARRSOC—Enable FD flag clear by RSOC threshold 0 = Disabled 1 = Enabled (default) Bit 4: FCSETV—Enable FC flag set by cell voltage threshold 0 = Disabled 1 = Enabled (default) Bit 5: FCCLEARV—Enable FC flag clear by cell voltage threshold 0 = Disabled 1 = Enabled (default) Bit 6: FCSETRSOC—Enable FC flag set by RSOC threshold 0 = Disabled 1 = Enabled (default) Bit 7: FCCLEARRSOC—Enable FC flag clear by RSOC threshold 0 = Disabled 1 = Enabled (default)

12.8.5.8 SBS Data Configuration

Class	Subclass	Name	Type	Min	Max	Default	Description
Settings	Configuration	SBS Data Config 0–15	H2	0x0000	0xFFFF	0x0CAF	Bit 0: TDASETV—Enable TDA flag set by cell voltage threshold 0 = Disabled 1 = Enabled (default) Bit 1: TDACLEARV—Enable TDA flag clear by cell voltage threshold 0 = Disabled 1 = Enabled (default) Bit 2: TDASETRSOC—Enable TDA flag set by RSOC threshold 0 = Disabled 1 = Enabled (default) Bit 3: TDACLEARRSOC—Enable TDA flag clear by RSOC threshold 0 = Disabled 1 = Enabled (default) Bit 4: TCASETV—Enable TCA flag set by cell voltage threshold 0 = Disabled 1 = Enabled (default) Bit 5: TCACLEARV—Enable TCA flag clear by cell voltage threshold 0 = Disabled 1 = Enabled (default) Bit 6: TCASETRSOC—Enable TCA flag set by RSOC threshold 0 = Disabled 1 = Enabled (default) Bit 7: TCACLEARRSOC—Enable TCA flag clear by RSOC threshold 0 = Disabled 1 = Enabled (default) Bit 8: TCACLEARCT—Enable TCA flag clear valid charge termination 0 = Disabled 1 = Enabled (default) Bit 9: FCCLEARCT—Enable FC flag clear by valid charge termination 0 = Disabled 1 = Enabled (default) Bit 10: FCSETVCT—Enable FC flag set on valid charge termination 0 = Disabled 1 = Enabled (default) Bit 11: TCASETVCT—Enable TCA flag set on valid charge termination 0 = Disabled 1 = Enabled (default) Bit 12: Reserved Bit 13: Reserved Bit 14: Reserved Bit 15: Reserved
		SBS Data Config 16–32	H1	0x00	0xFF	0xFF	Bit 0: FDSETV—Enable FD flag set by cell voltage threshold 0 = Disabled 1 = Enabled (default) Bit 1: FDCLEARV—Enable FD flag clear by cell voltage threshold 0 = Disabled 1 = Enabled (default) Bit 2: FDSETRSOC—Enable FD flag set by RSOC threshold 0 = Disabled 1 = Enabled (default) Bit 3: FDCLEARRSOC—Enable FD flag clear by RSOC threshold 0 = Disabled 1 = Enabled (default) Bit 4: FCSETV—Enable FC flag set by cell voltage threshold 0 = Disabled 1 = Enabled (default) Bit 5: FCCLEARV—Enable FC flag clear by cell voltage threshold 0 = Disabled 1 = Enabled (default) Bit 6: FCSETRSOC—Enable FC flag set by RSOC threshold 0 = Disabled 1 = Enabled (default) Bit 7: FCCLEARRSOC—Enable FC flag clear by RSOC threshold 0 = Disabled 1 = Enabled (default)

12.8.6 AFE

Class	Subclass	Name	Type	Min	Max	Default	Description
Configuration	AFE	AFE State Control	H1	0x00	0xFF	0	AFE state after device start up Bit 0: Reserved Bit 1: Reserved Bit 2: Reserved Bit 3: Reserved Bit 4: RSNS Divide OLD, SCC, SDC1 and SCD2 voltage thresholds by 2 0 = Disabled (default) 1 = Enabled Bit 5: SCDDx2 Double SCD1 and SCD2 delay thresholds 0 = Disabled (default) 1 = Enabled Bit 6: Reserved Bit 7: Reserved

12.9 Power

12.9.1 Power

Class	Subclass	Name	Type	Min	Max	Default	Unit	Description
Power	Power	Valid Update Voltage	I2	0	32767	7500	mV	Min stack voltage threshold for Flash update, pack based

12.9.2 Shutdown

Class	Subclass	Name	Type	Min	Max	Default	Unit	Description
Power	Shutdown	Shutdown Voltage	I2	0	32767	1750	mV	Cell based shutdown voltage trip threshold
Power	Shutdown	Shutdown Time	U2	0	255	10	s	Cell based shutdown voltage trip delay
Power	Shutdown	Charger Present Threshold	I2	0	32767	3000	mV	Pack pin charger present detect threshold, pack based

12.9.3 Sleep

Class	Subclass	Name	Type	Min	Max	Default	Unit	Description
Power	Sleep	Sleep Current	I2	0	32767	10	mA	<i>Current()</i> threshold to enter Sleep mode
Power	Sleep	Voltage Time	U1	0	255	5	s	Voltage sampling period in Sleep mode
Power	Sleep	Current Time	U1	0	255	20	s	Current sampling period in Sleep mode

12.9.4 Ship

Class	Subclass	Name	Type	Min	Max	Default	Unit	Description
Power	Ship	Delay	I2	0	255	5	s	SHIP Mode entry delay
Power	Ship	Current	I2	-250	250	10	mA	<i>Current()</i> threshold to enter SHIP Mode

12.10 Gas Gauging

12.10.1 Current Thresholds

Class	Subclass	Name	Type	Min	Max	Default	Unit	Description
Gas Gauging	Current Thresholds	Dsg Current Threshold	I2	-32768	32767	100	mA	Discharge mode <i>Current()</i> threshold
Gas Gauging	Current Thresholds	Chg Current Threshold	I2	-32768	32767	50	mA	Charge mode <i>Current()</i> threshold
Gas Gauging	Current Thresholds	Quit Current	I2	0	32767	10	mA	<i>Current()</i> threshold to enter rest mode

12.10.2 State

Class	Subclass	Name	Type	Min	Max	Default	Unit	Description
Gas Gauging	State	QMax Cell 0	I2	0	32767	4400	mAh	QMax Cell 0
Gas Gauging	State	QMax Cell 1	I2	0	32767	4400	mAh	QMax Cell 1
Gas Gauging	State	QMax Cell 2	I2	0	32767	4400	mAh	QMax Cell 2
Gas Gauging	State	QMax Cell 3	I2	0	32767	4400	mAh	QMax Cell 3
Gas Gauging	State	QMax Pack	I2	0	32767	4400	mAh	QMax of the whole stack
Gas Gauging	State	Update Status	H1	0x00	0xFF	0		Bit 1:0: Update1, Update0 Update Status 0,0 = Impedance Track gauging and lifetime updating is disabled 0,1 = Ra table updated 1,0 = QMax and Ra table have been updated Bit 2: Enable—Impedance Track gauging and lifetime updating enable 0 = Disabled 1 = Enabled Bit 3: is_QMax_Field_Updated QMax updated with FC and qualified OCV in charge and discharge 0 = Disabled 1 = Enabled (default) Bit 4: Reserved Bit 5: Reserved Bit 6: Reserved Bit 7: Reserved
Gas Gauging	State	Cell 0 Chg Voltage at EoC	I2	0	32767	4200	mV	Cell 0 voltage value at end of charge
Gas Gauging	State	Cell 1 Chg Voltage at EoC	I2	0	32767	4200	mV	Cell 1 voltage value at end of charge
Gas Gauging	State	Cell 2 Chg Voltage at EoC	I2	0	32767	4200	mV	Cell 2 voltage value at end of charge
Gas Gauging	State	Cell 3 Chg Voltage at EoC	I2	0	32767	4200	mV	Cell 3 voltage value at end of charge
Gas Gauging	State	Current at EoC	I2	-32768	32767	250	mA	Current at end of charge
Gas Gauging	State	Avg I Last Run	I2	-32768	32767	-2000	mA	Average current last discharge cycle
Gas Gauging	State	Avg P Last Run	I2	-32768	32767	-3022	10 mW	Average power last discharge cycle
Gas Gauging	State	Delta Voltage	I2	-32768	32767	0	mV	<i>Voltage()</i> delta between normal and short load spikes to optimize run time calculation
Gas Gauging	State	Max I Last Run	I2	-32768	32767	-2000	mA	Max current last discharge cycle
Gas Gauging	State	Max P Last Run	I2	-32768	32767	-3022	10 mW	Max power last discharge cycle

12.11 IT Config

Class	Subclass	Name	Type	Min	Max	Default	Unit	Description
Gas Gauging	IT Cfg	Load Select	U1	0	255	7		Defines Load compensation mode used by gauging algorithm:IF Load Mode = 0:0 = Avg I Last Run 1 = Present average discharge current 2 = Current 3 = AverageCurrent 4 = DesignCapacity/5 5 = AtRate (mA) 6 = User-Rate-mA 7 = Max Avg I Last RunIF Load Mode = 1:0 = Avg P Last Run 1 = Present average discharge power 2 = Current × Voltage 3 = AverageCurrent × Average Voltage 4 = DesignEnergy/5 5 = AtRate (10 mW) 6 = User-Rate-mW 7 = Max Avg P Last Run
Gas Gauging	IT Cfg	Load Mode	U1	0	255	0		Defines unit used by gauging algorithm: 0 = Constant Current 1 = Constant Power
Gas Gauging	IT Cfg	Ra Filter	U2	0	999	500	0.1%	Filter value used in Ra Updates, specifies what percentage or Ra update is from new value (100%—setting) vs. old value (setting). The recommended setting is 80% if RSOC_CONV feature is enabled. Otherwise, the setting should be 50% as default.
Gas Gauging	IT Cfg	Ra Max Delta	U1	0	255	15	% of Design Resistance	Maximum value of allowed Ra change
Gas Gauging	IT Cfg	Design Resistance						Averaged cell resistance at Reference Grid point. Automatically updated when Update Status is set to 0x6 by the gauge. To automatically update again set Update Status to 0x4 or manually set when Update Status is set to 0x6.
Gas Gauging	IT Cfg	Reference Grid	UI	0	15	4		Reference grid point used by Design Resistance. The default setting should be used if RSOC_CONV feature is enabled. Otherwise, grid point 11 should be used to ensure resistance updates fast enough at the grid where discharge termination occurs.
Gas Gauging	IT Cfg	Resistance Parameter Filter	U2	1	65534	65142	—	This is one of the filters used for resistance update. Reducing this filter setting can improve low temperature performance at high rates. The default setting is 41-s time constant. It is recommended to keep this filter within the range of 4 s (that is, DF setting = 61680) up to the default 41 s (that is, DF setting = 65142). Examining the Term Voltage Delta setting and Fast Scale Start SOC should be done prior to twisting this parameter when trying to improve the RSOC performance. The following is the formula to convert the DF setting into actual filter time constant: Filter time constant = $[0.25/(1 - (DF_Value / 65536))] - 0.25$
Gas Gauging	IT Cfg	Term Voltage	I2	0	32767	9000	mV	Min stack voltage to be used for capacity calculation

Class	Subclass	Name	Type	Min	Max	Default	Unit	Description
Gas Gauging	IT Cfg	Term Voltage Delta	I2	0	32767	300	mV	Controls when the RSOC_CONV feature becomes active. The recommended setting is 3.3 –Term Voltage/Number Cells. The default setting is 300 mV, which is assuming a typical 3-V termination voltage per cell. If a different termination voltage is used, this parameter should be adjusted accordingly.
Gas Gauging	IT Cfg	User-Rate-mA	I2	–32768	32768	0	mA	Discharge rate used for capacity calculation selected by Load Select
Gas Gauging	IT Cfg	User-Rate-mW	I2	–32768	32768	0	10 mW	Discharge rate used for capacity calculation selected by Load Select
Gas Gauging	IT Cfg	Reserve Cap-mAh	I2	0	32768	0	mAh	Capacity reserved available when gauging algorithm reports 0% <i>RemainingStateOfCharge()</i>
Gas Gauging	IT Cfg	Reserve Cap-mWh	I2	0	32768	0	10 mW	Capacity reserved available when gauging algorithm reports 0% <i>RemainingStateOfCharge()</i>
Gas Gauging	IT Cfg	Max IR Correct	I2	0	32767	400	mV	Maximum allowable I*R voltage delta for correction
Gas Gauging	IT Cfg	RemCap Smoothing Filter	U1	0	255	250		<i>RemainingCapacity()</i> smoothing filter value. Sample settings and associated low-pass filter time constants are in Table C-1 .
Gas Gauging	IT Cfg	Fast Scale Start SOC	U1	0	100	10	%	Control the start of RSOC_CONV feature based on RSOC %. Rising this setting can improve RSOC drop at the end of discharge. However, the RSOC % chosen for this setting must keep after the sharp drop of the discharge curve (the keen of the discharge curve).

12.12 LED Config

Class	Subclass	Name	Type	Min	Max	Default	Unit	Description
LED Support	LED Config	LED Flash Period	U2	0	65535	2048	122 μs	LED Flashing period for alarm display
LED Support	LED Config	LED Blink Period	U2	0	65535	4096	122 μs	LED Blinking period for state-of-charge display
LED Support	LED Config	LED Delay	U2	0	65535	400	122 μs	Delay time from LED to LED for state-of-charge display
LED Support	LED Config	LED Hold Time	U2	0	255	16	0.25 s	LED display active time
LED Support	LED Config	CHG Flash Alarm	I1	0	100	10	%	<i>RelativeStateOfCharge()</i> alarm threshold during charging
LED Support	LED Config	CHG Thresh 1	I1	0	100	0	%	<i>RelativeStateOfCharge()</i> threshold for LED1 during charging
LED Support	LED Config	CHG Thresh 2	I1	0	100	20	%	<i>RelativeStateOfCharge()</i> threshold for LED2 during charging
LED Support	LED Config	CHG Thresh 3	I1	0	100	40	%	<i>RelativeStateOfCharge()</i> threshold for LED3 during charging
LED Support	LED Config	CHG Thresh 4	I1	0	100	60	%	<i>RelativeStateOfCharge()</i> threshold for LED4 during charging
LED Support	LED Config	CHG Thresh 5	I1	0	100	80	%	<i>RelativeStateOfCharge()</i> threshold for LED5 during charging
LED Support	LED Config	DSG Flash Alarm	I1	0	100	10	%	<i>RelativeStateOfCharge()</i> alarm threshold during discharging
LED Support	LED Config	DSG Thresh 1	I1	0	100	0	%	<i>RelativeStateOfCharge()</i> threshold for LED1 during discharging
LED Support	LED Config	DSG Thresh 2	I1	0	100	20	%	<i>RelativeStateOfCharge()</i> threshold for LED2 during discharging
LED Support	LED Config	DSG Thresh 3	I1	0	100	40	%	<i>RelativeStateOfCharge()</i> threshold for LED3 during discharging

Class	Subclass	Name	Type	Min	Max	Default	Unit	Description
LED Support	LED Config	DSG Thresh 4	I1	0	100	60	%	<i>RelativeStateOfCharge()</i> threshold for LED4 during discharging
LED Support	LED Config	DSG Thresh 5	I1	0	100	80	%	<i>RelativeStateOfCharge()</i> threshold for LED5 during discharging

12.13 RA Table

12.13.1 R_a0

Class	Subclass	Name	Type	Min	Max	Unit	Description
RA Table	R_a0	Cell 0 R_A Flag	H2	0x0000	0xFFFF		High Byte: 0x00: Cell Impedance and QMax updated 0x05: RELAXATION mode and QMax update in progress 0x55: Discharge mode and cell updated 0xFF: cell impedance never updated Low-Byte: 0x00: Table not used and QMax updated 0x55: Table being used 0xFF: Table never used, no QMax or cell impedance update .
RA Table	R_a0	Cell 0 R_A 0	I2	-32768	32768	2 ⁻¹⁰ Ω	Cell 0 resistance at grid point 0
RA Table	R_a0	Cell 0 R_A 1	I2	-32768	32768	2 ⁻¹⁰ Ω	Cell 0 resistance at grid point 1
RA Table	R_a0	Cell 0 R_A 2	I2	-32768	32768	2 ⁻¹⁰ Ω	Cell 0 resistance at grid point 2
RA Table	R_a0	Cell 0 R_A 3	I2	-32768	32768	2 ⁻¹⁰ Ω	Cell 0 resistance at grid point 3
RA Table	R_a0	Cell 0 R_A 4	I2	-32768	32768	2 ⁻¹⁰ Ω	Cell 0 resistance at grid point 4
RA Table	R_a0	Cell 0 R_A 5	I2	-32768	32768	2 ⁻¹⁰ Ω	Cell 0 resistance at grid point 5
RA Table	R_a0	Cell 0 R_A 6	I2	-32768	32768	2 ⁻¹⁰ Ω	Cell 0 resistance at grid point 6
RA Table	R_a0	Cell 0 R_A 7	I2	-32768	32768	2 ⁻¹⁰ Ω	Cell 0 resistance at grid point 7
RA Table	R_a0	Cell 0 R_A 8	I2	-32768	32768	2 ⁻¹⁰ Ω	Cell 0 resistance at grid point 8
RA Table	R_a0	Cell 0 R_A 9	I2	-32768	32768	2 ⁻¹⁰ Ω	Cell 0 resistance at grid point 9
RA Table	R_a0	Cell 0 R_A 10	I2	-32768	32768	2 ⁻¹⁰ Ω	Cell 0 resistance at grid point 10
RA Table	R_a0	Cell 0 R_A 11	I2	-32768	32768	2 ⁻¹⁰ Ω	Cell 0 resistance at grid point 11
RA Table	R_a0	Cell 0 R_A 12	I2	-32768	32768	2 ⁻¹⁰ Ω	Cell 0 resistance at grid point 12
RA Table	R_a0	Cell 0 R_A 13	I2	-32768	32768	2 ⁻¹⁰ Ω	Cell 0 resistance at grid point 13
RA Table	R_a0	Cell 0 R_A 14	I2	-32768	32768	2 ⁻¹⁰ Ω	Cell 0 resistance at grid point 14

12.13.2 R_a1

Class	Subclass	Name	Type	Min	Max	Unit	Description
RA Table	R_a1	Cell 1 R_A Flag	H2	0x0000	0xFFFF		High-Byte: 0x00: Cell Impedance and QMax updated 0x05: RELAXATION mode and QMax update in progress 0x55: Discharge mode and cell updated 0xFF: Cell impedance never updated Low-Byte: 0x00: Table not used and QMax updated 0x55: Table being used 0xFF: Table never used, no QMax or cell impedance update
RA Table	R_a1	Cell 1 R_A 0	I2	-32768	32768	2 ⁻¹⁰ Ω	Cell 1 resistance at grid point 0
RA Table	R_a1	Cell 1 R_A 1	I2	-32768	32768	2 ⁻¹⁰ Ω	Cell 1 resistance at grid point 1
RA Table	R_a1	Cell 1 R_A 2	I2	-32768	32768	2 ⁻¹⁰ Ω	Cell 1 resistance at grid point 2

Class	Subclass	Name	Type	Min	Max	Unit	Description
RA Table	R_a1	Cell 1 R_A 3	I2	-32768	32768	2 ⁻¹⁰ Ω	Cell 1 resistance at grid point 3
RA Table	R_a1	Cell 1 R_A 4	I2	-32768	32768	2 ⁻¹⁰ Ω	Cell 1 resistance at grid point 4
RA Table	R_a1	Cell 1 R_A 5	I2	-32768	32768	2 ⁻¹⁰ Ω	Cell 1 resistance at grid point 5
RA Table	R_a1	Cell 1 R_A 6	I2	-32768	32768	2 ⁻¹⁰ Ω	Cell 1 resistance at grid point 6
RA Table	R_a1	Cell 1 R_A 7	I2	-32768	32768	2 ⁻¹⁰ Ω	Cell 1 resistance at grid point 7
RA Table	R_a1	Cell 1 R_A 8	I2	-32768	32768	2 ⁻¹⁰ Ω	Cell 1 resistance at grid point 8
RA Table	R_a1	Cell 1 R_A 9	I2	-32768	32768	2 ⁻¹⁰ Ω	Cell 1 resistance at grid point 9
RA Table	R_a1	Cell 1 R_A 10	I2	-32768	32768	2 ⁻¹⁰ Ω	Cell 1 resistance at grid point 10
RA Table	R_a1	Cell 1 R_A 11	I2	-32768	32768	2 ⁻¹⁰ Ω	Cell 1 resistance at grid point 11
RA Table	R_a1	Cell 1 R_A 12	I2	-32768	32768	2 ⁻¹⁰ Ω	Cell 1 resistance at grid point 12
RA Table	R_a1	Cell 1 R_A 13	I2	-32768	32768	2 ⁻¹⁰ Ω	Cell 1 resistance at grid point 13
RA Table	R_a1	Cell 1 R_A 14	I2	-32768	32768	2 ⁻¹⁰ Ω	Cell 1 resistance at grid point 14

12.13.3 R_a2

Class	Subclass	Name	Type	Min	Max	Unit	Description
RA Table	R_a2	Cell 2 R_A Flag	H2	0x0000	0xFFFF		High-Byte: 0x00: Cell Impedance and QMax updated 0x05: RELAXATION mode and QMax update in progress 0x55: Discharge mode and cell updated 0xFF: cell impedance never updated Low-Byte: 0x00: Table not used and QMax updated 0x55: Table being used 0xFF: Table never used, no QMax or cell impedance update
RA Table	R_a2	Cell 2 R_A 0	I2	-32768	32768	2 ⁻¹⁰ Ω	Cell 2 resistance at grid point 0
RA Table	R_a2	Cell 2 R_A 1	I2	-32768	32768	2 ⁻¹⁰ Ω	Cell 2 resistance at grid point 1
RA Table	R_a2	Cell 2 R_A 2	I2	-32768	32768	2 ⁻¹⁰ Ω	Cell 2 resistance at grid point 2
RA Table	R_a2	Cell 2 R_A 3	I2	-32768	32768	2 ⁻¹⁰ Ω	Cell 2 resistance at grid point 3
RA Table	R_a2	Cell 2 R_A 4	I2	-32768	32768	2 ⁻¹⁰ Ω	Cell 2 resistance at grid point 4
RA Table	R_a2	Cell 2 R_A 5	I2	-32768	32768	2 ⁻¹⁰ Ω	Cell 2 resistance at grid point 5
RA Table	R_a2	Cell 2 R_A 6	I2	-32768	32768	2 ⁻¹⁰ Ω	Cell 2 resistance at grid point 6
RA Table	R_a2	Cell 2 R_A 7	I2	-32768	32768	2 ⁻¹⁰ Ω	Cell 2 resistance at grid point 7
RA Table	R_a2	Cell 2 R_A 8	I2	-32768	32768	2 ⁻¹⁰ Ω	Cell 2 resistance at grid point 8
RA Table	R_a2	Cell 2 R_A 9	I2	-32768	32768	2 ⁻¹⁰ Ω	Cell 2 resistance at grid point 9
RA Table	R_a2	Cell 2 R_A 10	I2	-32768	32768	2 ⁻¹⁰ Ω	Cell 2 resistance at grid point 10
RA Table	R_a2	Cell 2 R_A 11	I2	-32768	32768	2 ⁻¹⁰ Ω	Cell 2 resistance at grid point 11
RA Table	R_a2	Cell 2 R_A 12	I2	-32768	32768	2 ⁻¹⁰ Ω	Cell 2 resistance at grid point 12
RA Table	R_a2	Cell 2 R_A 13	I2	-32768	32768	2 ⁻¹⁰ Ω	Cell 2 resistance at grid point 13
RA Table	R_a2	Cell 2 R_A 14	I2	-32768	32768	2 ⁻¹⁰ Ω	Cell 2 resistance at grid point 14

12.13.4 R_a3

Class	Subclass	Name	Type	Min	Max	Unit	Description
RA Table	R_a3	Cell 3 R_A Flag	H2	0x0000	0xFFFF		High-Byte: 0x00: Cell Impedance and QMax updated 0x05: RELAXATION mode and QMax update in progress 0x55: Discharge mode and cell updated 0xFF: cell impedance never updated Low-Byte: 0x00: Table not used and QMax updated 0x55: Table being used 0xFF: Table never used, no QMax or cell impedance update
RA Table	R_a3	Cell 3 R_A 0	I2	-32768	32768	2 ⁻¹⁰ Ω	Cell 3 resistance at grid point 0
RA Table	R_a3	Cell 3 R_A 1	I2	-32768	32768	2 ⁻¹⁰ Ω	Cell 3 resistance at grid point 1
RA Table	R_a3	Cell 3 R_A 2	I2	-32768	32768	2 ⁻¹⁰ Ω	Cell 3 resistance at grid point 2
RA Table	R_a3	Cell 3 R_A 3	I2	-32768	32768	2 ⁻¹⁰ Ω	Cell 3 resistance at grid point 3
RA Table	R_a3	Cell 3 R_A 4	I2	-32768	32768	2 ⁻¹⁰ Ω	Cell 3 resistance at grid point 4
RA Table	R_a3	Cell 3 R_A 5	I2	-32768	32768	2 ⁻¹⁰ Ω	Cell 3 resistance at grid point 5
RA Table	R_a3	Cell 3 R_A 6	I2	-32768	32768	2 ⁻¹⁰ Ω	Cell 3 resistance at grid point 6
RA Table	R_a3	Cell 3 R_A 7	I2	-32768	32768	2 ⁻¹⁰ Ω	Cell 3 resistance at grid point 7
RA Table	R_a3	Cell 3 R_A 8	I2	-32768	32768	2 ⁻¹⁰ Ω	Cell 3 resistance at grid point 8
RA Table	R_a3	Cell 3 R_A 9	I2	-32768	32768	2 ⁻¹⁰ Ω	Cell 3 resistance at grid point 9
RA Table	R_a3	Cell 3 R_A 10	I2	-32768	32768	2 ⁻¹⁰ Ω	Cell 3 resistance at grid point 10
RA Table	R_a3	Cell 3 R_A 11	I2	-32768	32768	2 ⁻¹⁰ Ω	Cell 3 resistance at grid point 11
RA Table	R_a3	Cell 3 R_A 12	I2	-32768	32768	2 ⁻¹⁰ Ω	Cell 3 resistance at grid point 12
RA Table	R_a3	Cell 3 R_A 13	I2	-32768	32768	2 ⁻¹⁰ Ω	Cell 3 resistance at grid point 13
RA Table	R_a3	Cell 3 R_A 14	I2	-32768	32768	2 ⁻¹⁰ Ω	Cell 3 resistance at grid point 14

12.13.5 R_a0x

Class	Subclass	Name	Type	Min	Max	Unit	Description
RA Table	R_a0x	xCell 0 R_A Flag	H2	0x0000	0xFFFF		High-Byte: 0x00: Cell Impedance and QMax updated 0x05: RELAXATION mode and QMax update in progress 0x55: Discharge mode and cell updated 0xFF: cell impedance never updated Low-Byte: 0x00: Table not used and QMax updated 0x55: Table being used 0xFF: Table never used, no QMax or cell impedance update
RA Table	R_a0x	xCell 0 R_A 0	I2	-32768	32768	2 ⁻¹⁰ Ω	Cell 0 resistance at grid point 0
RA Table	R_a0x	xCell 0 R_A 1	I2	-32768	32768	2 ⁻¹⁰ Ω	Cell 0 resistance at grid point 1
RA Table	R_a0x	xCell 0 R_A 2	I2	-32768	32768	2 ⁻¹⁰ Ω	Cell 0 resistance at grid point 2
RA Table	R_a0x	xCell 0 R_A 3	I2	-32768	32768	2 ⁻¹⁰ Ω	Cell 0 resistance at grid point 3
RA Table	R_a0x	xCell 0 R_A 4	I2	-32768	32768	2 ⁻¹⁰ Ω	Cell 0 resistance at grid point 4
RA Table	R_a0x	xCell 0 R_A 5	I2	-32768	32768	2 ⁻¹⁰ Ω	Cell 0 resistance at grid point 5
RA Table	R_a0x	xCell 0 R_A 6	I2	-32768	32768	2 ⁻¹⁰ Ω	Cell 0 resistance at grid point 6
RA Table	R_a0x	xCell 0 R_A 7	I2	-32768	32768	2 ⁻¹⁰ Ω	Cell 0 resistance at grid point 7
RA Table	R_a0x	xCell 0 R_A 8	I2	-32768	32768	2 ⁻¹⁰ Ω	Cell 0 resistance at grid point 8
RA Table	R_a0x	xCell 0 R_A 9	I2	-32768	32768	2 ⁻¹⁰ Ω	Cell 0 resistance at grid point 9
RA Table	R_a0x	xCell 0 R_A 10	I2	-32768	32768	2 ⁻¹⁰ Ω	Cell 0 resistance at grid point 10
RA Table	R_a0x	xCell 0 R_A 11	I2	-32768	32768	2 ⁻¹⁰ Ω	Cell 0 resistance at grid point 11

Class	Subclass	Name	Type	Min	Max	Unit	Description
RA Table	R_a0x	xCell 0 R_A 12	I2	-32768	32768	2 ⁻¹⁰ Ω	Cell 0 resistance at grid point 12
RA Table	R_a0x	xCell 0 R_A 13	I2	-32768	32768	2 ⁻¹⁰ Ω	Cell 0 resistance at grid point 13
RA Table	R_a0x	xCell 0 R_A 14	I2	-32768	32768	2 ⁻¹⁰ Ω	Cell 0 resistance at grid point 14

12.13.6 R_a1x

Class	Subclass	Name	Type	Min	Max	Unit	Description
RA Table	R_a1x	xCell 1 R_A Flag	H2	0x0000	0xFFFF		High-Byte: 0x00: Cell Impedance and QMax updated 0x05: RELAXATION mode and QMax update in progress 0x55: Discharge mode and Cell updated 0xFF: cell impedance never updated Low-Byte: 0x00: Table not used and QMax updated 0x55: Table being used 0xFF: Table never used, no QMax or cell impedance update
RA Table	R_a1x	xCell 1 R_A 0	I2	-32768	32768	2 ⁻¹⁰ Ω	Cell 1 resistance at grid point 0
RA Table	R_a1x	xCell 1 R_A 1	I2	-32768	32768	2 ⁻¹⁰ Ω	Cell 1 resistance at grid point 1
RA Table	R_a1x	xCell 1 R_A 2	I2	-32768	32768	2 ⁻¹⁰ Ω	Cell 1 resistance at grid point 2
RA Table	R_a1x	xCell 1 R_A 3	I2	-32768	32768	2 ⁻¹⁰ Ω	Cell 1 resistance at grid point 3
RA Table	R_a1x	xCell 1 R_A 4	I2	-32768	32768	2 ⁻¹⁰ Ω	Cell 1 resistance at grid point 4
RA Table	R_a1x	xCell 1 R_A 5	I2	-32768	32768	2 ⁻¹⁰ Ω	Cell 1 resistance at grid point 5
RA Table	R_a1x	xCell 1 R_A 6	I2	-32768	32768	2 ⁻¹⁰ Ω	Cell 1 resistance at grid point 6
RA Table	R_a1x	xCell 1 R_A 7	I2	-32768	32768	2 ⁻¹⁰ Ω	Cell 1 resistance at grid point 7
RA Table	R_a1x	xCell 1 R_A 8	I2	-32768	32768	2 ⁻¹⁰ Ω	Cell 1 resistance at grid point 8
RA Table	R_a1x	xCell 1 R_A 9	I2	-32768	32768	2 ⁻¹⁰ Ω	Cell 1 resistance at grid point 9
RA Table	R_a1x	xCell 1 R_A 10	I2	-32768	32768	2 ⁻¹⁰ Ω	Cell 1 resistance at grid point 10
RA Table	R_a1x	xCell 1 R_A 11	I2	-32768	32768	2 ⁻¹⁰ Ω	Cell 1 resistance at grid point 11
RA Table	R_a1x	xCell 1 R_A 12	I2	-32768	32768	2 ⁻¹⁰ Ω	Cell 1 resistance at grid point 12
RA Table	R_a1x	xCell 1 R_A 13	I2	-32768	32768	2 ⁻¹⁰ Ω	Cell 1 resistance at grid point 13
RA Table	R_a1x	xCell 1 R_A 14	I2	-32768	32768	2 ⁻¹⁰ Ω	Cell 1 resistance at grid point 14

12.13.7 R_a2x

Class	Subclass	Name	Type	Min	Max	Unit	Description
RA Table	R_a2x	xCell 2 R_A Flag	H2	0x0000	0xFFFF		High-Byte: 0x00: Cell Impedance and QMax updated 0x05: RELAXATION mode and QMax update in progress 0x55: Discharge mode and cell updated 0xFF: cell impedance never updated Low-Byte: 0x00: Table not used and QMax updated 0x55: Table being used 0xFF: Table never used, no QMax or cell impedance update
RA Table	R_a2x	xCell 2 R_A 0	I2	-32768	32768	2 ⁻¹⁰ Ω	Cell 2 resistance at grid point 0
RA Table	R_a2x	xCell 2 R_A 1	I2	-32768	32768	2 ⁻¹⁰ Ω	Cell 2 resistance at grid point 1
RA Table	R_a2x	xCell 2 R_A 2	I2	-32768	32768	2 ⁻¹⁰ Ω	Cell 2 resistance at grid point 2

Class	Subclass	Name	Type	Min	Max	Unit	Description
RA Table	R_a2x	xCell 2 R_A 3	I2	-32768	32768	2 ⁻¹⁰ Ω	Cell 2 resistance at grid point 3
RA Table	R_a2x	xCell 2 R_A 4	I2	-32768	32768	2 ⁻¹⁰ Ω	Cell 2 resistance at grid point 4
RA Table	R_a2x	xCell 2 R_A 5	I2	-32768	32768	2 ⁻¹⁰ Ω	Cell 2 resistance at grid point 5
RA Table	R_a2x	xCell 2 R_A 6	I2	-32768	32768	2 ⁻¹⁰ Ω	Cell 2 resistance at grid point 6
RA Table	R_a2x	xCell 2 R_A 7	I2	-32768	32768	2 ⁻¹⁰ Ω	Cell 2 resistance at grid point 7
RA Table	R_a2x	xCell 2 R_A 8	I2	-32768	32768	2 ⁻¹⁰ Ω	Cell 2 resistance at grid point 8
RA Table	R_a2x	xCell 2 R_A 9	I2	-32768	32768	2 ⁻¹⁰ Ω	Cell 2 resistance at grid point 9
RA Table	R_a2x	xCell 2 R_A 10	I2	-32768	32768	2 ⁻¹⁰ Ω	Cell 2 resistance at grid point 10
RA Table	R_a2x	xCell 2 R_A 11	I2	-32768	32768	2 ⁻¹⁰ Ω	Cell 2 resistance at grid point 11
RA Table	R_a2x	xCell 2 R_A 12	I2	-32768	32768	2 ⁻¹⁰ Ω	Cell 2 resistance at grid point 12
RA Table	R_a2x	xCell 2 R_A 13	I2	-32768	32768	2 ⁻¹⁰ Ω	Cell 2 resistance at grid point 13
RA Table	R_a2x	xCell 2 R_A 14	I2	-32768	32768	2 ⁻¹⁰ Ω	Cell 2 resistance at grid point 14

12.13.8 R_a3x

Class	Subclass	Name	Type	Min	Max	Unit	Description
RA Table	R_a3x	xCell 3 R_A Flag	H2	0x0000	0xFFFF		High-Byte: 0x00: Cell Impedance and QMax updated 0x05: RELAXATION mode and QMax update in progress 0x55: Discharge mode and cell updated 0xFF: cell impedance never updated Low-Byte: 0x00: Table not used and QMax updated 0x55: Table being used 0xFF: Table never used, no QMax or cell impedance update
RA Table	R_a3x	xCell 3 R_A 0	I2	-32768	32768	2 ⁻¹⁰ Ω	Cell 3 resistance at grid point 0
RA Table	R_a3x	xCell 3 R_A 1	I2	-32768	32768	2 ⁻¹⁰ Ω	Cell 3 resistance at grid point 1
RA Table	R_a3x	xCell 3 R_A 2	I2	-32768	32768	2 ⁻¹⁰ Ω	Cell 3 resistance at grid point 2
RA Table	R_a3x	xCell 3 R_A 3	I2	-32768	32768	2 ⁻¹⁰ Ω	Cell 3 resistance at grid point 3
RA Table	R_a3x	xCell 3 R_A 4	I2	-32768	32768	2 ⁻¹⁰ Ω	Cell 3 resistance at grid point 4
RA Table	R_a3x	xCell 3 R_A 5	I2	-32768	32768	2 ⁻¹⁰ Ω	Cell 3 resistance at grid point 5
RA Table	R_a3x	xCell 3 R_A 6	I2	-32768	32768	2 ⁻¹⁰ Ω	Cell 3 resistance at grid point 6
RA Table	R_a3x	xCell 3 R_A 7	I2	-32768	32768	2 ⁻¹⁰ Ω	Cell 3 resistance at grid point 7
RA Table	R_a3x	xCell 3 R_A 8	I2	-32768	32768	2 ⁻¹⁰ Ω	Cell 3 resistance at grid point 8
RA Table	R_a3x	xCell 3 R_A 9	I2	-32768	32768	2 ⁻¹⁰ Ω	Cell 3 resistance at grid point 9
RA Table	R_a3x	xCell 3 R_A 10	I2	-32768	32768	2 ⁻¹⁰ Ω	Cell 3 resistance at grid point 10
RA Table	R_a3x	xCell 3 R_A 11	I2	-32768	32768	2 ⁻¹⁰ Ω	Cell 3 resistance at grid point 11
RA Table	R_a3x	xCell 3 R_A 12	I2	-32768	32768	2 ⁻¹⁰ Ω	Cell 3 resistance at grid point 12
RA Table	R_a3x	xCell 3 R_A 13	I2	-32768	32768	2 ⁻¹⁰ Ω	Cell 3 resistance at grid point 13
RA Table	R_a3x	xCell 3 R_A 14	I2	-32768	32768	2 ⁻¹⁰ Ω	Cell 3 resistance at grid point 14

12.14 PF Status

12.14.1 Device Status Data

Class	Subclass	Name	Type	Min	Max	Default	Description
PF Status	Device Status Data	Safety Alert 0–15	H2	0x0000	0xFFFF	0	SafetyAlert() bit 0 to bit 15 Bit 0: CUV—Cell Undervoltage 0 = Inactive 1 = Detected Bit 1: COV—Cell Overvoltage 0 = Inactive 1 = Detected Bit 2: OCC1—Overcurrent in Charge 1st Tier 0 = Inactive 1 = Detected Bit 3: OCC2—Overcurrent in Charge 2nd Tier 0 = Inactive 1 = Detected Bit 4: OCD1—Overcurrent in Discharge 1st Tier 0 = Inactive 1 = Detected Bit 5: OCD2—Overcurrent in Discharge 2nd Tier 0 = Inactive 1 = Detected Bit 6: OLD—Overload in discharge 0 = Inactive 1 = Detected Bit 7: OLDL—Overload in discharge latch 0 = Inactive 1 = Detected Bit 8: SCC—Short circuit in charge 0 = Inactive 1 = Detected Bit 9: SCCL—Short circuit in charge latch 0 = Inactive 1 = Detected Bit 10: SCD—Short circuit in discharge 0 = Inactive 1 = Detected Bit 11: SCDL—Short circuit in discharge latch 0 = Inactive 1 = Detected Bit 12: OTC—Overtemperature in charge 0 = Inactive 1 = Detected Bit 13: OTD—Overtemperature in discharge 0 = Inactive 1 = Detected Bit 14: CUVC—I*R compensated CUV 0 = Inactive 1 = Detected Bit 15: Reserved

Class	Subclass	Name	Type	Min	Max	Default	Description
PF Status	Device Status Data	Safety Status 0–15	H2	0x0000	0xFFFF	0	<i>SafetyStatus()</i> bit 0 to bit 15 Bit 0: CUV—Cell Undervoltage 0 = Inactive 1 = Detected Bit 1: COV—Cell Overvoltage 0 = Inactive 1 = Detected Bit 2: OCC1—Overcurrent in Charge 1st Tier 0 = Inactive 1 = Detected Bit 3: OCC2—Overcurrent in Charge 2nd Tier 0 = Inactive 1 = Detected Bit 4: OCD1—Overcurrent in Discharge 1st Tier 0 = Inactive 1 = Detected Bit 5: OCD2—Overcurrent in Discharge 2nd Tier 0 = Inactive 1 = Detected Bit 6: OLD—Overload in discharge 0 = Inactive 1 = Detected Bit 7: OLDL—Overload in discharge latch 0 = Inactive 1 = Detected Bit 8: SCC—Short circuit in charge 0 = Inactive 1 = Detected Bit 9: SCCL—Short circuit in charge latch 0 = Inactive 1 = Detected Bit 10: SCD—Short circuit in discharge 0 = Inactive 1 = Detected Bit 11: SCDL—Short circuit in discharge latch 0 = Inactive 1 = Detected Bit 12: OTC—Overtemperature in charge 0 = Inactive 1 = Detected Bit 13: OTD—Overtemperature in discharge 0 = Inactive 1 = Detected Bit 14: CUVC—I*R compensated CUV 0 = Inactive 1 = Detected Bit 15: Reserved

Class	Subclass	Name	Type	Min	Max	Default	Description
PF Status	Device Status Data	PF Alert 0–15	H2	0x0000	0xFFFF	0	<i>PFAlert()</i> bit 0 to bit 15 Bit 0: CUV—Cell undervoltage 0 = Inactive 1 = Detected Bit 1: COV—Cell overvoltage 0 = Inactive 1 = Detected Bit 2: CUDEP—Copper Deposition 0 = Inactive 1 = Detected Bit 3: Reserved Bit 4: OTCE—Overtemperature 0 = Inactive 1 = Detected Bit 5: Reserved Bit 6: OTF—Overtemperature FET 0 = Inactive 1 = Detected Bit 7: QIM—QMax Imbalance 0 = Inactive 1 = Detected Bit 8: CB—Cell balancing 0 = Inactive 1 = Detected Bit 9: IMP—Cell impedance 0 = Inactive 1 = Detected Bit 10: CD—Capacity Deterioration 0 = Inactive 1 = Detected Bit 11: VIMR—Voltage imbalance at Rest 0 = Inactive 1 = Detected Bit 12: VIMA—Voltage imbalance at Rest 0 = Inactive 1 = Detected Bit 13: Reserved Bit 14: Reserved Bit 15: Reserved
PF Status	Device Status Data	PF Status 0–15	H2	0x0000	0xFFFF	0	<i>PFStatus()</i> bit 0 to bit 15 Bit 0: CUV—Cell undervoltage 0 = Inactive 1 = Active Bit 1: COV—Cell overvoltage 0 = Inactive 1 = Active Bit 2: Reserved Bit 3: Reserved Bit 4: OTCE—Overtemperature 0 = Inactive 1 = Active Bit 5: Reserved Bit 6: OTF—Overtemperature FET 0 = Inactive 1 = Active Bit 7: QIM—QMax Imbalance 0 = Inactive 1 = Active Bit 8: CB—Cell balancing 0 = Inactive 1 = Active Bit 9: IMP—Cell impedance 0 = Inactive 1 = Active Bit 10: CD—Capacity Deterioration 0 = Inactive 1 = Active Bit 11: VIMR—Voltage imbalance at Rest 0 = Inactive 1 = Active Bit 12: VIMA—Voltage imbalance at Rest 0 = Inactive 1 = Active Bit 13: Reserved Bit 14: Reserved Bit 15: Reserved

Class	Subclass	Name	Type	Min	Max	Default	Description
PF Status	Device Status Data	Safety Alert 16–31	H2	0x0000	0xFFFF	0	<i>SafetyAlert()</i> bit 16 to bit 31 Bit 16: OTF—FET overtemperature 0 = Inactive 1 = Detected Bit 17: HWD—SBS Host watchdog timeout 0 = Inactive 1 = Detected Bit 18: PTO—Pre-charging timeout 0 = Inactive 1 = Detected Bit 19: PTOS—Pre-charging timeout suspend 0 = Inactive 1 = Detected Bit 20: CTO—Charging timeout 0 = Inactive 1 = Detected Bit 21: CTOS—Charging timeout suspend 0 = Inactive 1 = Detected Bit 22: OC—Overcharge 0 = Inactive 1 = Detected Bit 23: CHGC—Charging Current higher than requested 0 = Inactive 1 = Detected Bit 24: CHGV—Charging Voltage higher than requested 0 = Inactive 1 = Detected Bit 25: Reserved Bit 26: Reserved Bit 27: Reserved Bit 28: Reserved Bit 29: Reserved Bit 30: Reserved Bit 31: Reserved
PF Status	Device Status Data	Safety Status 16–31	H2	0x0000	0xFFFF	0	<i>SafetyStatus()</i> bit 16 to bit 31 Bit 16: OTF—FET overtemperature 0 = Inactive 1 = Detected Bit 17: HWD—SBS Host watchdog timeout 0 = Inactive 1 = Detected Bit 18: PTO—Pre-charging timeout 0 = Inactive 1 = Detected Bit 19: PTOS—Pre-charging timeout suspend 0 = Inactive 1 = Detected Bit 20: CTO—Charging timeout 0 = Inactive 1 = Detected Bit 21: CTOS—Charging timeout suspend 0 = Inactive 1 = Detected Bit 22: OC—Overcharge 0 = Inactive 1 = Detected Bit 23: CHGC—Charging Current higher than requested 0 = Inactive 1 = Detected Bit 24: CHGV—Charging Voltage higher than requested 0 = Inactive 1 = Detected Bit 25: Reserved Bit 26: Reserved Bit 27: Reserved Bit 28: Reserved Bit 29: Reserved Bit 30: Reserved Bit 31: Reserved

Class	Subclass	Name	Type	Min	Max	Default	Description
PF Status	Device Status Data	PF Alert 16–31	H2	0x0000	0xFFFF	0	<i>PFAlert()</i> bit 16 to bit 31 Bit 16: CFETF—Charge FET 0 = Inactive 1 = Detected Bit 17: DFET—Discharge FET 0 = Inactive 1 = Detected Bit 18: TH—Thermistor 0 = Inactive 1 = Detected Bit 19: FUSE—Fuse 0 = Inactive 1 = Detected Bit 20: AFER—AFE Register 0 = N/A 1 = Detected Bit 21: AFEC—AFE Communication 0 = Inactive 1 = Detected Bit 22: 2LVL—FUSE input indicating fuse trigger by external 2nd level protection 0 = Inactive 1 = Detected Bit 23: Reserved Bit 24: Reserved Bit 25: OCECO—Open VCx 0 = N/A 1 = Detected Bit 26: Reserved Bit 27: Reserved Bit 28: Reserved Bit 29: Reserved Bit 30: Reserved Bit 31: Reserved
PF Status	Device Status Data	PF Status 16–31	H2	0x0000	0xFFFF	0	<i>PFStatus()</i> bit 16 to bit 31 Bit 16: CFETF—Charge FET 0 = Inactive 1 = Active Bit 17: DFET—Discharge FET 0 = Inactive 1 = Active Bit 18: TH—Thermistor 0 = Inactive 1 = Active Bit 19: FUSE—Fuse 0 = Inactive 1 = Active Bit 20: AFER—AFE Register 0 = N/A 1 = Active Bit 21: AFEC—AFE Communication 0 = Inactive 1 = Active Bit 22: 2LVL—FUSE input indicating fuse trigger by external 2nd level protection 0 = Inactive 1 = Active Bit 23: PTC—PTC by AFE 0 = Inactive 1 = Active Bit 24: IFC—Instruction Flash Checksum 0 = N/A 1 = IF checksum failure Bit 25: OCECO—Open VCx 0 = N/A 1 = Active Bit 26: DFW—DF wearout 0 = N/A 1 = Active Bit 27: Reserved Bit 28: Reserved Bit 29: Reserved Bit 30: Reserved Bit 31: Reserved

Class	Subclass	Name	Type	Min	Max	Default	Description
PF Status	Device Status Data	PF Status 16–31	H2	0x0000	0xFFFF	0	Bit 16: SDM—Shutdown activated by <i>ManufacturerAccess()</i> 0 = Inactive 1 = Active Bit 17: SHIPM—SHIP Mode activated with <i>ManufacturerAccess()</i> 0 = Inactive 1 = Active Bit 18: AUTH—Authentication ongoing 0 = Inactive 1 = Active Bit 19: AWD—AFE Watchdog failure 0 = Inactive 1 = Active Bit 20: FVS—Fast Voltage Sampling 0 = Inactive 1 = Active Bit 21: CALO—Raw ADC/CC offset output 0 = Inactive 1 = Active Bit 22: SDV—Shutdown activated by voltage 0 = Inactive 1 = Active Bit 23: SLEEPM—Sleep mode active by <i>ManufacturerAccess()</i> 0 = Inactive 1 = Active Bit 24: INIT Initialization after full reset, cleared when SBS data calculated and available 0 = Inactive 1 = Active Bit 25: SMBL CAL—CC auto offset calibration ongoing after SBS line goes low 0 = Inactive 1 = Active Bit 26: SLEEPQMax—QMax update in Sleep mode 0 = Inactive 1 = Active Bit 27: SLEEPCC—Checking current in Sleep mode 0 = Inactive 1 = Active Bit 28: GPOD—GPOD pin status 0 = Inactive (high) 1 = Active (low) Bit 29: Reserved Bit 30: Reserved Bit 31: Reserved

Class	Subclass	Name	Type	Min	Max	Default	Description
PF Status	Device Status Data	Operation Status 0–15	H2	0x0000	0xFFFF	0	<i>OperationStatus()</i> bit 0 to bit 15 Bit 0: PRES—PRES input state 0 = PRES pin high 1 = PRES pin low Detected Bit 1: DSG—DSG FET Status 0 = Disabled 1 = Enabled Bit 2: CHG—CHG FET Status 0 = Disabled 1 = Enabled Bit 3: PCHG—PCHG FET Status 0 = Disabled 1 = Enabled Bit 4: GPOD—PPOD FET Status 0 = Disabled 1 = Enabled Bit 5: FUSE—FUSE input 0 = FUSE pin low 1 = FUSE pin high Detected Bit 6: CB—Cell Balancing 0 = Inactive 1 = Active Bit 7: LED—LED Display 0 = Inactive 1 = Active Bit 8:9: SEC0,SEC1—Security Mode 0,0 = Reserved 0,1 = Unsealed 1,0 = Full Access 1,1 = Sealed Bit 10: CALCAL Raw ADC/CC output active 0 = Inactive 1 = Active Bit 11: SS—SafetyStatus 0 = Inactive 1 = Active Bit 12: PF—Permanent Failure 0 = Inactive 1 = Active Bit 13: XDSD—Discharging Disabled 0 = Inactive 1 = Active Bit 14: XCHG—Charging Disabled 0 = Inactive 1 = Active Bit 15: SLEEP—Sleep condition met 0 = Disabled 1 = Enabled

Class	Subclass	Name	Type	Min	Max	Default	Description
PF Status	Device Status Data	Operation Status 16–31	H2	0x0000	0xFFFF	0	<p><i>OperationStatus()</i> bit 16 to bit 31</p> <p>Bit 16: SDM—Shutdown activated by <i>ManufacturerAccess()</i> 0 = Inactive 1 = Active</p> <p>Bit 17: SHIPM—SHIP Mode activated with <i>ManufacturerAccess()</i> 0 = Inactive 1 = Active</p> <p>Bit 18: AUTH—Authentication ongoing 0 = Inactive 1 = Active</p> <p>Bit 19: AWD—AFE Watchdog failure 0 = Inactive 1 = Active</p> <p>Bit 20: FVS—Fast Voltage Sampling 0 = Inactive 1 = Active</p> <p>Bit 21: CALO—Raw ADC/CC offset output 0 = Inactive 1 = Active</p> <p>Bit 22: SDV—Shutdown activated by voltage 0 = Inactive 1 = Active</p> <p>Bit 23: SLEEPM—Sleep mode active by <i>ManufacturerAccess()</i> 0 = Inactive 1 = Active</p> <p>Bit 24: INIT—Initialization after full reset, cleared when SBS data calculated and available 0 = Inactive 1 = Active</p> <p>Bit 25: SML—CALCC auto offset calibration ongoing after SBS line goes low 0 = Inactive 1 = Active</p> <p>Bit 26: SLEEPQMax—QMax update in Sleep mode 0 = Inactive 1 = Active</p> <p>Bit 27: SLEEPCC—Checking current in Sleep mode 0 = Inactive 1 = Active</p> <p>Bit 28: XLSBS Fast Mode 0 = Inactive 1 = Active</p> <p>Bit 29: Reserved</p> <p>Bit 30: Reserved</p> <p>Bit 31: Reserved</p>

Class	Subclass	Name	Type	Min	Max	Default	Description
PF Status	Device Status Data	Charging Status 0–15	H2	0x0000	0xFFFF	0	<i>ChargingStatus()</i> bit 0 to bit 15 Bit 0: UT—Under Temperature Range 0 = Inactive 1 = Active Bit 1: LT—Low Temperature Range 0 = Inactive 1 = Active Bit 2: ST—Standard Temperature Range 0 = Inactive 1 = Active Bit 3: HT—High Temperature Range 0 = Inactive 1 = Active Bit 4: RT—Recommended Temperature Range 0 = Inactive 1 = Active Bit 5: OT—Over Temperature Range 0 = Inactive 1 = Active Bit 6: PV—Precharge Voltage Range 0 = Inactive 1 = Active Bit 7: LV—Low Voltage Range 0 = Inactive 1 = Active Bit 8: MV—Medium Voltage Range 0 = Inactive 1 = Active Bit 9: HV—High Voltage Range 0 = Inactive 1 = Active Bit 10: IN—Charge Inhibit 0 = Inactive 1 = Active Bit 11: SU—Charge Suspend 0 = Inactive 1 = Active Bit 12: CCR— <i>ChargingVoltage()</i> Rate 0 = Inactive 1 = Active Bit 13: CVR— <i>ChargingCurrent()</i> Rate 0 = Inactive 1 = Active Bit 14: CCC— <i>ChargingCurrent()</i> Compensation 0 = Inactive 1 = Active Bit 15: Reserved
PF Status	Device Status Data	Charging Status 16–23	H2	0x0000	0xFFFF	0	<i>ChargingStatus()</i> bit 16 to bit 31 Bit 16: VCT—Valid Charge Termination. This flag toggles every time valid charge termination is Detected. Bit 17: Reserved Bit 18: Reserved Bit 19: Reserved Bit 20: Reserved Bit 21: Reserved Bit 22: Reserved Bit 23: Reserved Bit 24: Reserved

Class	Subclass	Name	Type	Min	Max	Default	Description
PF Status	Device Status Data	Gauging Status	H2	0x0000	0xFFFF	0	<i>GaugingStatus()</i> bit 0 to bit 15 Bit 0: REST—Device at rest 0 = Inactive 1 = Active Bit 1: DSG—Discharge Detected 0 = Charging 1 = Discharging Bit 2: RU—Resistance update 0 = Disabled 1 = Enabled Bit 3: VOK—Cell Voltage OK for QMax update 0 = Inactive 1 = Active Bit 4: QEN—QMax updates 0 = Disabled 1 = Enabled Bit 5: FD—Fully Discharged Detected by gauge algorithm 0 = Disabled 1 = Enabled Bit 6: FC—Fully Charged Detected by gauge algorithm 0 = Disabled 1 = Enabled
	PF Status	Device Status Data	Gauging Status	H2	0x0000	0xFFFF	Bit 7: NSFM—Negative scale factor mode 0 = Disabled 1 = Enabled Bit 8: VDQ—Discharge qualified for learning 0 = Disabled 1 = Enabled Bit 9: QMax—QMax updated. This flag toggles every time QMax is updated. Bit 10: RX—Resistance update This flag toggles every time Resistance is updated Bit 11: LDMD—Load Mode 0 = Constant current mode 1 = Constant power mode Bit 12: OCVFR—OCV in flat region 0 = OCV outside flat region 1 = OCV in flat region Bit 13: TDA—Terminate Discharge Alarm set by gauging algorithm 0 = Disabled 1 = Enabled Bit 14: TCA—Terminate Charge Alarm set by gauging algorithm 0 = Disabled 1 = Enabled Bit 15: LPF Relax—LiPh Relax Mode, only active with Chem ID 0x400 0 = Disabled 1 = Enabled

12.14.2 Device Voltage Data

Class	Subclass	Name	Type	Min	Max	Default	Unit	Description
PF Status	Device Voltage Data	Cell Voltage 0	I2	0	32767	0	mV	Cell 0 voltage
PF Status	Device Voltage Data	Cell Voltage 1	I2	0	32767	0	mV	Cell 1 voltage
PF Status	Device Voltage Data	Cell Voltage 2	I2	0	32767	0	mV	Cell 2 voltage
PF Status	Device Voltage Data	Cell Voltage 3	I2	0	32767	0	mV	Cell 3 voltage
PF Status	Device Voltage Data	Bat Direct Voltage	I2	0	32767	0	mV	Cell stack voltage
PF Status	Device Voltage Data	Pack Voltage	I2	0	32767	0	mV	Pack pin voltage

12.14.3 Device Current Data

Class	Subclass	Name	Type	Min	Max	Default	Unit	Description
PF Status	Device Current Data	Current	I2	-32768	32767	0	mV	Current()

12.14.4 Device Temperature Data

Class	Subclass	Name	Type	Min	Max	Default	Unit	Description
PF Status	Device Temperature Data	Internal Temperature	I2	0	9999	0	0.1°K	Internal temperature sensor temperature
PF Status	Device Temperature Data	External 1 Temperature	I2	0	9999	0	0.1°K	External TS1 temperature
PF Status	Device Temperature Data	External 2 Temperature	I2	0	9999	0	0.1°K	External TS2 temperature
PF Status	Device Temperature Data	External 3 Temperature	I2	0	9999	0	0.1°K	External TS3 temperature
PF Status	Device Temperature Data	External 4 Temperature	I2	0	9999	0	0.1°K	External TS4 temperature

12.14.5 Device Gauging Data

Class	Subclass	Name	Type	Min	Max	Default	Unit	Description
PF Status	Device Gauging Data	Cell 0 DOD0	I2	0	32767	0		Cell 0 depth of discharge
PF Status	Device Gauging Data	Cell 1 DOD0	I2	0	32767	0		Cell 1 depth of discharge
PF Status	Device Gauging Data	Cell 2 DOD0	I2	0	32767	0		Cell 2 depth of discharge
PF Status	Device Gauging Data	Cell 3 DOD0	I2	0	32767	0		Cell 3 depth of discharge
PF Status	Device Gauging Data	Passed Charge	I2	0	32767	0	mAh	Passed charge since last QMax update

12.14.6 AFE Regs

Class	Subclass	Name	Type	Min	Max	Default	Description
PF Status	AFE Regs	AFE Status	H1	0x00	0xFF	0	Bit 0: SCD1—SCD1 0 = Inactive 1 = Active Bit 1: SCD2—SCD2 0 = Inactive 1 = Active Bit 2: SCC—SCC 0 = Inactive 1 = Active Bit 3: OCD—SCD1 0 = Inactive 1 = Active Bit 4: WDF—WDF 0 = Inactive 1 = Active Bit 5: Reserved Bit 6: PTC—PTC 0 = Inactive 1 = Active Bit 7: FUSE—FUSE 0 = Inactive 1 = Active

Class	Subclass	Name	Type	Min	Max	Default	Description
PF Status	AFE Regs	AFE State Control	H1	0x00	0xFF	0	Bit 0: Reserved Bit 1: SHUTDOWN—Enables device shutdown when voltage on PACK pins is removed 0 = Disabled 1 = Enabled Bit 2: WDDIS—Enables device watchdog timer 0 = Enabled 1 = Disabled Bit 3: WDRST—Enables device reset when watchdog timer times out 0 = Disabled 1 = Enabled Bit 4: RSNS—Divide OCD, SCC, SDC1, and SCD2 voltage thresholds by 2 0 = Disabled 1 = Enabled Bit 5: SCDDx2—Double SCD1 and SCD2 Delay thresholds 0 = Disabled 1 = Enabled Bit 6: CTM_ENA—Enable customer test mode 0 = Disabled 1 = Enabled Bit 7: FUSE—A part one of FUSE activation sequence 0 = Disabled 1 = Enabled
PF Status	AFE Regs	AFE Control	H1	0x00	0xFF	0	Bit 0: LTCLR—Clear latch condition 0 = Inactive 1 = Active Bit 1: DSG 0 = Inactive 1 = Active Bit 2: CHG 0 = Inactive 1 = Active Bit 3: PCHG—CHG 0 = Inactive 1 = Active Bit 4: GPOD—CHG 0 = Inactive 1 = Active Bit 5: PMS_CHG 0 = Inactive 1 = Active Bit 6: CTM_ENB 0 = Inactive 1 = Active Bit 7: FUSEB 0 = Inactive 1 = Active
PF Status	AFE Regs	AFE Output Status	H1	0x00	0xFF	0	Bit 0: Reserved Bit 1: DSG 0 = Inactive 1 = Active Bit 2: CHG 0 = Inactive 1 = Active Bit 3: PCHG—CHG 0 = Inactive 1 = Active Bit 4: GPOD—CHG 0 = Inactive 1 = Active Bit 5: PMS_CHG 0 = Inactive 1 = Active Bit 6: CTM 0 = Inactive 1 = Active Bit 7: PMS 0 = Inactive 1 = Active

Class	Subclass	Name	Type	Min	Max	Default	Description
PF Status	AFE Regs	AFE Function Control	H1	0x00	0xFF	0	Bit 0: VMEN 0 = Inactive 1 = Active Bit 1: PACK 0 = Inactive 1 = Active Bit 2: BATDSG 0 = Inactive 1 = Active Bit 3: SC_REC 0 = Inactive 1 = Active Bit 5:4: RV1,RV0:RV Bit 6: Reserved Bit 7: Reserved
PF Status	AFE Regs	AFE Cell Select	H1	0x00	0xFF	0	Bit 1:0: CELL1, CELL0 Cell Select Bit 2: CALCAL 0 = Inactive 1 = Active Bit 3: Reserved Bit 4: CB0 0 = Inactive 1 = Active Bit 5: CB1 0 = Inactive 1 = Active Bit 6: CB2 0 = Inactive 1 = Active Bit 4: CB3 0 = Inactive 1 = Active
PF Status	AFE Regs	AFE OCDV	H1	0x00	0xFF	0	Bit 3:0: Overload Trip Threshold between SRP and SRN 0x00 to 0x0F = 0.050 V to 0.200 V in 10 mV steps when RSNS = 00x00 to 0x0F = 0.025 V to 0.100 V in 5 mV steps when RSNS = 10x00 = 0.050 V or 0.025 V 0x01 = 0.060 V or 0.030 V 0x02 = 0.070 V or 0.035 V 0x03 = 0.080 V or 0.040 V 0x04 = 0.090 V or 0.045 V 0x05 = 0.100 V or 0.050 V 0x06 = 0.110 V or 0.055 V 0x07 = 0.120 V or 0.060 V 0x08 = 0.130 V or 0.065 V 0x09 = 0.140 V or 0.070 V 0x0A = 0.150 V or 0.075 V 0x0B = 0.160 V or 0.080 V 0x0C = 0.170 V or 0.085 V 0x0D = 0.180 V or 0.090 V 0x0E = 0.190 V or 0.095 V 0x0F = 0.200 V or 0.100 V
PF Status	AFE Regs	AFE OCDT	H1	0x00	0xFF	0	Bit 3:0: Overload Trip Delay 0x00 to 0x0F = 1 ms to 31 ms in 2-ms steps 0x00 = 1 ms 0x01 = 3 ms 0x02 = 5 ms 0x03 = 7 ms 0x04 = 9 ms 0x05 = 11 ms 0x06 = 13 ms 0x07 = 15 ms 0x08 = 17 ms 0x09 = 19 ms 0x0A = 21 ms 0x0B = 23 ms 0x0C = 25 ms 0x0D = 27 ms 0x0E = 29 ms

Class	Subclass	Name	Type	Min	Max	Default	Description
PF Status	AFE Regs	AFE SCC	H1	0x00	0xFF	0	Bit 2:0: Short Circuit in Charge Threshold between SRP and SRN 0x00 to 0x04 = -0.100 V to -0.300 V in 50 mV steps when RSNS = 00x00 to 0x04 = -0.050 V to -0.150 V in 25-mV steps when RSNS = 1 0x00 = -0.100 V or -0.050 V 0x01 = -0.150 V or -0.075 V 0x02 = -0.200 V or -0.100 V 0x03 = -0.250 V or -0.125 V 0x04 = -0.300 V or -0.150 V 0x05 = Reserved 0x06 = Reserved 0x07 = Reserved Bit 3: Reserved Bit 7:4: Short Circuit in Charge Delay Time 0x00 to 0x0F = 0 μ s to 915 μ s in 61- μ s steps 0x00 = 0 μ s 0x01 = 61 μ s 0x02 = 122 μ s 0x03 = 183 μ s 0x04 = 244 μ s 0x05 = 305 μ s 0x06 = 366 μ s 0x07 = 427 μ s 0x08 = 488 μ s 0x09 = 549 μ s 0x0A = 610 μ s 0x0B = 671 μ s 0x0C = 732 μ s 0x0D = 793 μ s 0x0E = 854 μ s 0x0F = 915 μ s
PF Status	AFE Regs	AFE SCD1	H1	0x00	0xFF	0	Bit 2:0: Short Circuit in Discharge 1 Threshold between SRP and SRN 0x00 to 0x07 = 0.100 V to 0.300 V in 50 mV steps when RSNS = 00x00 to 0x07 = 0.050 V to 0.150 V in 25 mV steps when RSNS = 1 0x00 = 0.100 V or 0.050 V 0x01 = 0.150 V or 0.075 V 0x02 = 0.200 V or 0.100 V 0x03 = 0.250 V or 0.125 V 0x04 = 0.300 V or 0.150 V 0x05 = 0.350 V or 0.175 V 0x06 = 0.400 V or 0.200 V 0x07 = 0.450 V or 0.225 V Bit 3: Reserved
PF Status	AFE Regs	AFE SCD1	H1	0x00	0xFF	0	Bit 7:4: Short Circuit in Discharge 1 Delay Time 0x00 to 0x0F = 0 μ s to 915 μ s in 61- μ s steps when SCDDx2 = 00x00 to 0x0F = 0 μ s to 1830 μ s in 122- μ s steps when SCDDx2 = 1 0x00 = 0 μ s 0x01 = 61 μ s or 122 μ s 0x02 = 122 μ s or 244 μ s 0x03 = 183 μ s or 366 μ s 0x04 = 244 μ s or 488 μ s 0x05 = 305 μ s or 610 μ s 0x06 = 366 μ s or 732 μ s 0x07 = 427 μ s or 854 μ s 0x08 = 488 μ s or 976 μ s 0x09 = 549 μ s or 1098 μ s 0x0A = 610 μ s or 1220 μ s 0x0B = 671 μ s or 1342 μ s 0x0C = 732 μ s or 1464 μ s 0x0D = 793 μ s or 1586 μ s 0x0E = 854 μ s or 1708 μ s 0x0F = 915 μ s or 1830 μ s

Class	Subclass	Name	Type	Min	Max	Default	Description
PF Status	AFE Regs	AFE SCD2	H1	0x00	0xFF	0	Bit 2:0: Short Circuit in Discharge 2 Threshold between SRP and SRN 0x00 to 0x07 = 0.100 V to 0.300 V in 50-mV steps when RSNS = 00x00 to 0x07 = 0.050 V to 0.150 V in 25-mV steps when RSNS = 10x00 = 0.100 V or 0.050 V 0x01 = 0.150 V or 0.075 V 0x02 = 0.200 V or 0.100 V 0x03 = 0.250 V or 0.125 V 0x04 = 0.300 V or 0.150 V 0x05 = 0.350 V or 0.175 V 0x06 = 0.400 V or 0.200 V 0x07 = 0.450 V or 0.225 V Bit 3: Reserved Bit 7:4: Short Circuit in Discharge 2 Delay Time 0x00 to 0x0F = 0 μs to 915 μs in 61-μs steps when SCDDx2 = 00x00 to 0x0F = 0 μs to 1830 μs in 122-μs steps when SCDDx2 = 10x00 = 0 μs 0x01 = 30 μs or 61 μs 0x02 = 61 μs or 122 μs 0x03 = 91 μs or 183 μs 0x04 = 122 μs or 244 μs 0x05 = 152 μs or 305 μs 0x06 = 183 μs or 366 μs 0x07 = 213 μs or 427 μs 0x08 = 244 μs or 488 μs 0x09 = 275 μs or 549 μs 0x0A = 305 μs or 610 μs 0x0B = 335 μs or 671 μs 0x0C = 366 μs or 732 μs 0x0D = 396 μs or 793 μs 0x0E = 426 μs or 854 μs 0x0F = 458 μs or 915 μs

12.15 Black Box

12.15.1 Safety Status

Class	Subclass	Name	Type	Min	Max	Default	Description
Black Box	Safety Status	1st Safety Status 0–15	H2	0x0000	0xFFFF	0	<i>SafetyStatus()</i> bit 0 to bit 15 Bit 0: CUV—Cell Undervoltage 0 = Inactive 1 = Detected Bit 1: COV—Cell Overvoltage 0 = Inactive 1 = Detected Bit 2: OCC1—Overcurrent in Charge 1st Tier 0 = Inactive 1 = Detected Bit 3: OCC2—Overcurrent in Charge 2nd Tier 0 = Inactive 1 = Detected Bit 4: OCD1—Overcurrent in Discharge 1st Tier 0 = Inactive 1 = Detected Bit 5: OCD2—Overcurrent in Discharge 2nd Tier 0 = Inactive 1 = Detected Bit 6: OLD—Overload in discharge 0 = Inactive 1 = Detected Bit 7: OLDL—Overload in discharge latch 0 = Inactive 1 = Detected Bit 8: SCC—Short circuit in charge 0 = Inactive 1 = Detected

Class	Subclass	Name	Type	Min	Max	Default	Description
Black Box	Safety Status	1st Safety Status 0–15	H2	0x0000	0xFFFF	0	Bit 9: SCCL—Short circuit in charge latch 0 = Inactive 1 = Detected Bit 10: SCD—Short circuit in discharge 0 = Inactive 1 = Detected Bit 11: SCDL—Short circuit in discharge latch 0 = Inactive 1 = Detected Bit 12: OTC—Overtemperature in charge 0 = Inactive 1 = Detected Bit 13: OTD—Overtemperature in discharge 0 = Inactive 1 = Detected Bit 14: CUVC—I ² R compensated CUV 0 = Inactive 1 = Detected Bit 15: Reserved
Black Box	Safety Status	1st Safety Status 16–31	H2	0x0000	0xFFFF	0	<i>SafetyStatus()</i> bit 16 to bit 31 Bit 16: OTF—FET overtemperature 0 = Inactive 1 = Detected Bit 17: HWD—SBS Host watchdog timeout 0 = Inactive 1 = Detected Bit 18: PTO—Pre-charging Timeout 0 = Inactive 1 = Detected Bit 19: PTOS—Pre-charging Timeout Suspend 0 = Inactive 1 = Detected Bit 20: CTO—Charging Timeout 0 = Inactive 1 = Detected
Black Box	Safety Status	1st Safety Status 16–31	H2	0x0000	0xFFFF	0	Bit 21: CTOS—Charging Timeout Suspend 0 = Inactive 1 = Detected Bit 22: OC—Overcharge 0 = Inactive 1 = Detected Bit 23: CHGC—Charging Current higher than requested 0 = Inactive 1 = Detected Bit 24: CHGV—Charging Voltage higher than requested 0 = Inactive 1 = Detected Bit 25: Reserved Bit 26: Reserved Bit 27: Reserved Bit 28: Reserved Bit 29: Reserved Bit 30: Reserved Bit 31: Reserved
Black Box	Safety Status	1st Time to Next Event	U1	0	255	0	Time from 1st event to 2nd event

Class	Subclass	Name	Type	Min	Max	Default	Description
Black Box	Safety Status	2nd Safety Status 0–15	H2	0x0000	0xFFFF	0	<i>SafetyStatus()</i> bit 0 to bit 15 Bit 0: CUV—Cell Undervoltage 0 = Inactive 1 = Detected Bit 1: COV—Cell Overvoltage 0 = Inactive 1 = Detected Bit 2: OCC1—Overcurrent in Charge 1st Tier 0 = Inactive 1 = Detected Bit 3: OCC2—Overcurrent in Charge 2nd Tier 0 = Inactive 1 = Detected Bit 4: OCD1—Overcurrent in Discharge 1st Tier 0 = Inactive 1 = Detected Bit 5: OCD2—Overcurrent in Discharge 2nd Tier 0 = Inactive 1 = Detected Bit 6: OLD—Overload in Discharge 0 = Inactive 1 = Detected
Black Box	Safety Status	2nd Safety Status 0–15	H2	0x0000	0xFFFF	0	Bit 7: OLDL—Overload in discharge latch 0 = Inactive 1 = Detected Bit 8: SCC—Short circuit in charge 0 = Inactive 1 = Detected Bit 9: SCCL—Short circuit in charge latch 0 = Inactive 1 = Detected Bit 10: SCD—Short circuit in discharge 0 = Inactive 1 = Detected Bit 11: SCDL—Short circuit in discharge latch 0 = Inactive 1 = Detected Bit 12: OTC—Overtemperature in charge 0 = Inactive 1 = Detected Bit 13: OTD—Overtemperature in discharge 0 = Inactive 1 = Detected Bit 14: CUVC—I*R compensated CUV 0 = Inactive 1 = Detected Bit 15: Reserved
Black Box	Safety Status	2nd Safety Status 16–31	H2	0x0000	0xFFFF	0	<i>SafetyStatus()</i> bit 16 to bit 31 Bit 16: OTF—FET overtemperature 0 = Inactive 1 = Detected Bit 17: HWD—SBS Host watchdog timeout 0 = Inactive 1 = Detected Bit 18: PTO—Pre-charging timeout 0 = Inactive 1 = Detected Bit 19: PTOS—Pre-charging timeout suspend 0 = Inactive 1 = Detected Bit 20: CTO—Charging timeout 0 = Inactive 1 = Detected

Class	Subclass	Name	Type	Min	Max	Default	Description
Black Box	Safety Status	2nd Safety Status 16–31	H2	0x0000	0xFFFF	0	Bit 21: CTOS—Charging timeout suspend 0 = Inactive 1 = Detected Bit 22: OC—Overcharge 0 = Inactive 1 = Detected Bit 23: CHGC—Charging Current higher than requested 0 = Inactive 1 = Detected Bit 24: CHGV—Charging Voltage higher than requested 0 = Inactive 1 = Detected Bit 25: Reserved Bit 26: Reserved Bit 27: Reserved Bit 28: Reserved Bit 29: Reserved Bit 30: Reserved Bit 31: Reserved
Black Box	Safety Status	2nd Time to Next Event	U1	0	255	0	Time from 2nd event to 3rd event
Black Box	Safety Status	3rd Safety Status 0–15	H2	0x0000	0xFFFF	0	<i>SafetyStatus()</i> bit 0 to bit 15 Bit 0: CUV—Cell Undervoltage 0 = Inactive 1 = Detected Bit 1: COV—Cell Overvoltage 0 = Inactive 1 = Detected Bit 2: OCC1—Overcurrent in Charge 1st Tier 0 = Inactive 1 = Detected Bit 3: OCC2—Overcurrent in Charge 2nd Tier 0 = Inactive 1 = Detected Bit 4: OCD1—Overcurrent in Discharge 1st Tier 0 = Inactive 1 = Detected Bit 5: OCD2—Overcurrent in Discharge 2nd Tier 0 = Inactive 1 = Detected Bit 6: OLD—Overload in discharge 0 = Inactive 1 = Detected Bit 7: OLDL—Overload in discharge latch 0 = Inactive 1 = Detected
Black Box	Safety Status	3rd Safety Status 0–15	H2	0x0000	0xFFFF	0	Bit 8: SCC—Short circuit in charge 0 = Inactive 1 = Detected Bit 9: SCCL—Short circuit in charge latch 0 = Inactive 1 = Detected Bit 10: SCD—Short circuit in discharge 0 = Inactive 1 = Detected Bit 11: SCDL—Short circuit in discharge latch 0 = Inactive 1 = Detected Bit 12: OTC—Overtemperature in charge 0 = Inactive 1 = Detected Bit 13: OTD—Overtemperature in discharge 0 = Inactive 1 = Detected Bit 14: CUVC—I ² R compensated CUV 0 = Inactive 1 = Detected Bit 15: Reserved

Class	Subclass	Name	Type	Min	Max	Default	Description
Black Box	Safety Status	3rd Safety Status 16–31	H2	0x0000	0xFFFF	0	<i>SafetyStatus()</i> bit 16 to bit 31 Bit 16: OTF—FET Overtemperature 0 = Inactive 1 = Detected Bit 17: HWDSBS—Host Watchdog Timeout 0 = Inactive 1 = Detected Bit 18: PTO—Pre-charging Timeout 0 = Inactive 1 = Detected Bit 19: PTOS—Pre-charging Timeout Suspend 0 = Inactive 1 = Detected Bit 20: CTO—Charging Timeout 0 = Inactive 1 = Detected
Black Box	Safety Status	3rd Safety Status 16–31	H2	0x0000	0xFFFF	0	Bit 21: CTOS—Charging Timeout Suspend 0 = Inactive 1 = Detected Bit 22: OC—Overcharge 0 = Inactive 1 = Detected Bit 23: CHGC—Charging Current higher than requested 0 = Inactive 1 = Detected Bit 24: CHGV—Charging Voltage higher than requested 0 = Inactive 1 = Detected Bit 25: Reserved Bit 26: Reserved Bit 27: Reserved Bit 28: Reserved Bit 29: Reserved Bit 30: Reserved Bit 31: Reserved
Black Box	Safety Status	3rd Time to Next Event	U1	0	255		Time since 3rd event

12.15.2 PF Status

Class	Subclass	Name	Type	Min	Max	Default	Description
Black Box	PF Status	1st PF Status 0–15	H2	0x0000	0xFFFF	0	<i>PFStatus()</i> bit 0 to bit 15 Bit 0: CUV—Cell Undervoltage 0 = Inactive 1 = Active Bit 1: COV—Cell Overvoltage 0 = Inactive 1 = Active Bit 2: CUDEP—Copper Deposition 0 = Inactive 1 = Active Bit 3: Reserved Bit 4: OTCE—Overtemperature 0 = Inactive 1 = Active Bit 5: Reserved Bit 6: OTF—Overtemperature FET 0 = Inactive 1 = Active Bit 7: QIM—QMax Imbalance 0 = Inactive 1 = Active

Class	Subclass	Name	Type	Min	Max	Default	Description
Black Box	PF Status	1st PF Status 0–15	H2	0x0000	0xFFFF	0	Bit 8: CB—Cell Balancing 0 = Inactive 1 = Active Bit 9: IMP—Cell Impedance 0 = Inactive 1 = Active Bit 10: CD—Capacity Deterioration 0 = Inactive 1 = Active Bit 11: VIMR—Voltage Imbalance at Rest 0 = Inactive 1 = Active Bit 12: VIMA—Voltage Imbalance at Rest 0 = Inactive 1 = Active Bit 13: Reserved Bit 14: Reserved Bit 15: Reserved
Black Box	PF Status	1st PF Status 16–32	H2	0x0000	0xFFFF	0	<i>PFStatus()</i> bit 16 to bit 31 Bit 16: CFETF—Charge FET 0 = Inactive 1 = Active Bit 17: DFET—Discharge FET 0 = Inactive 1 = Active Bit 18: TH—Thermistor 0 = Inactive 1 = Active Bit 19: FUSE—Fuse 0 = Inactive 1 = Active Bit 20: AFER—AFE Register 0 = N/A 1 = Active Bit 21: AFEC—AFE Communication 0 = Inactive 1 = Active Bit 22: 2LVL—FUSE input indicating fuse trigger by external 2nd level protection 0 = Inactive 1 = Active Bit 23: PTC—PTC by AFE 0 = Inactive 1 = Active Bit 24: IFC—Instruction Flash Checksum 0 = N/A 1 = IF checksum failure Bit 25: OCECO—Open VCx 0 = N/A 1 = Active Bit 26: DFW—DF Wearout 0 = N/A 1 = Active Bit 27: Reserved Bit 28: Reserved Bit 29: Reserved Bit 30: Reserved Bit 31: Reserved

Class	Subclass	Name	Type	Min	Max	Default	Description
Black Box	PF Status	1st PF Status 16–32	H2	0x0000	0xFFFF	0	Bit 16: SDM—Shutdown activated by <i>ManufacturerAccess()</i> 0 = Inactive 1 = Active Bit 17: SHIPM—SHIP Mode activated with <i>ManufacturerAccess()</i> 0 = Inactive 1 = Active Bit 18: AUTH—Authentication ongoing 0 = Inactive 1 = Active Bit 19: AWD—AFE Watchdog failure 0 = Inactive 1 = Active Bit 20: FVS—Fast Voltage Sampling 0 = Inactive 1 = Active Bit 21: CALO—Raw ADC/CC offset output 0 = Inactive 1 = Active Bit 22: SDV—Shutdown activated by voltage 0 = Inactive 1 = Active Bit 23: SLEEPM—Sleep mode active by <i>ManufacturerAccess()</i> 0 = Inactive 1 = Active Bit 24: INIT—Initialization after full reset, cleared when SBS data calculated and available 0 = Inactive 1 = Active Bit 25: SMBCAL—CC auto offset calibration ongoing after SBS line goes low 0 = Inactive 1 = Active Bit 26: SLEEPQMax—QMax update in Sleep mode 0 = Inactive 1 = Active Bit 27: SLEEPCC—Checking Current in Sleep mode 0 = Inactive 1 = Active Bit 28: GPOD—GPOD pin status 0 = Inactive (high) 1 = Active (low) Bit 29: Reserved Bit 30: Reserved Bit 31: Reserved
Black Box	PF Status	1st Time to Next Event	U1	0	255	0	Time from 1st event to 2nd event

Class	Subclass	Name	Type	Min	Max	Default	Description
Black Box	PF Status	2nd PF Status 0–15	H2	0x0000	0xFFFF	0	PFStatus() bit 0 to bit 15 Bit 0: CUV—Cell Undervoltage 0 = Inactive 1 = Active Bit 1: COV—Cell Overvoltage 0 = Inactive 1 = Active Bit 2: CUDEP—Copper Deposition 0 = Inactive 1 = Active Bit 3: Reserved Bit 4: OTCE—Overtemperature 0 = Inactive 1 = Active Bit 5: Reserved Bit 6: OTF—Overtemperature FET 0 = Inactive 1 = Active Bit 7: QIM—QMax Imbalance 0 = Inactive 1 = Active Bit 8: CB—Cell Balancing 0 = Inactive 1 = Active Bit 9: IMP—Cell Impedance 0 = Inactive 1 = Active Bit 10: CD—Capacity Deterioration 0 = Inactive 1 = Active Bit 11: VIMR—Voltage Imbalance at Rest 0 = Inactive 1 = Active Bit 12: VIMA—Voltage Imbalance at Rest 0 = Inactive 1 = Active Bit 13: Reserved Bit 14: Reserved Bit 15: Reserved
Black Box	PF Status	2nd PF Status 16–32	H2	0x0000	0xFFFF	0	PFStatus() bit 16 to bit 31 Bit 16: CFETF—Charge FET 0 = Inactive 1 = Active Bit 17: DFET—Discharge FET 0 = Inactive 1 = Active Bit 18: TH—Thermistor 0 = Inactive 1 = Active Bit 19: FUSE—Fuse 0 = Inactive 1 = Active Bit 20: AFER—AFE Register 0 = N/A 1 = Active Bit 21: AFEC—AFE Communication 0 = Inactive 1 = Active Bit 22: 2LVL—FUSE input indicating fuse trigger by external 2nd level protection 0 = Inactive 1 = Active Bit 23: PTC—PTC by AFE 0 = Inactive 1 = Active Bit 24: IFC—Instruction Flash Checksum 0 = N/A 1 = IF checksum failure Bit 25: OCECO—Open VCx 0 = N/A 1 = Active Bit 26: DFW—DF wearout 0 = N/A 1 = Active Bit 27: Reserved Bit 28: Reserved Bit 29: Reserved Bit 30: Reserved Bit 31: Reserved

Class	Subclass	Name	Type	Min	Max	Default	Description
Black Box	PF Status	2nd PF Status 16–32	H2	0x0000	0xFFFF	0	Bit 16: SDM—Shutdown activated by <i>ManufacturerAccess()</i> 0 = Inactive 1 = Active Bit 17: SHIPM—SHIP Mode activated with <i>ManufacturerAccess()</i> 0 = Inactive 1 = Active Bit 18: AUTH—Authentication ongoing 0 = Inactive 1 = Active Bit 19: AWD—AFE Watchdog failure 0 = Inactive 1 = Active Bit 20: FVS—Fast Voltage Sampling 0 = Inactive 1 = Active Bit 21: CALO—Raw ADC/CC offset output 0 = Inactive 1 = Active Bit 22: SDV—Shutdown activated by voltage 0 = Inactive 1 = Active Bit 23: SLEEPM—Sleep mode active by <i>ManufacturerAccess()</i> 0 = Inactive 1 = Active Bit 24: INIT—Initialization after full reset, cleared when SBS data calculated and available 0 = Inactive 1 = Active Bit 25: SMBCAL—CC auto offset calibration ongoing after SBS line goes low 0 = Inactive 1 = Active Bit 26: SLEEPQMax—QMax update in Sleep mode 0 = Inactive 1 = Active Bit 27: SLEEPCC—Checking current in Sleep mode 0 = Inactive 1 = Active Bit 28: GPOD—GPOD pin status 0 = Inactive (high) 1 = Active (low) Bit 29: Reserved Bit 30: Reserved Bit 31: Reserved
Black Box	PF Status	2nd Time to Next Event	U1	0	255	0	Time from 2nd event to 3rd event

Class	Subclass	Name	Type	Min	Max	Default	Description
Black Box	PF Status	3rd PF Status 0–15	H2	0x0000	0xFFFF	0	<i>PFStatus()</i> bit 0 to bit 15 Bit 0: CUV—Cell undervoltage 0 = Inactive 1 = Active Bit 1: COV—Cell overvoltage 0 = Inactive 1 = Active Bit 2: CUDEP—Copper Deposition 0 = Inactive 1 = Active Bit 3: Reserved Bit 4: OTCE—Overtemperature 0 = Inactive 1 = Active Bit 5: Reserved Bit 6: OTF—Overtemperature FET 0 = Inactive 1 = Active Bit 7: QIM—QMax Imbalance 0 = Inactive 1 = Active Bit 8: CB—Cell balancing 0 = Inactive 1 = Active Bit 9: IMP—Cell impedance 0 = Inactive 1 = Active Bit 10: CD—Capacity Deterioration 0 = Inactive 1 = Active Bit 11: VIMR—Voltage imbalance at Rest 0 = Inactive 1 = Active Bit 12: VIMA—Voltage imbalance at Rest 0 = Inactive 1 = Active Bit 13: Reserved Bit 14: Reserved Bit 15: Reserved
Black Box	PF Status	3rd PF Status 16–32	H2	0x0000	0xFFFF	0	<i>PFStatus()</i> bit 16 to bit 31 Bit 16: CFETF—Charge FET 0 = Inactive 1 = Active Bit 17: DFET—Discharge FET 0 = Inactive 1 = Active Bit 18: TH—Thermistor 0 = Inactive 1 = Active Bit 19: FUSE—Fuse 0 = Inactive 1 = Active Bit 20: AFER—AFE Register 0 = N/A 1 = Active Bit 21: AFEC—AFE Communication 0 = Inactive 1 = Active Bit 22: 2LVL—FUSE input indicating fuse trigger by external 2nd level protection 0 = Inactive 1 = Active Bit 23: PTC—PTC by AFE 0 = Inactive 1 = Active Bit 24: IFC—Instruction Flash Checksum 0 = N/A 1 = IF checksum failure Bit 25: OCECO—Open VCx 0 = N/A 1 = Active Bit 26: DFW—DF wearout 0 = N/A 1 = Active Bit 27: Reserved Bit 28: Reserved Bit 29: Reserved Bit 30: Reserved Bit 31: Reserved

Class	Subclass	Name	Type	Min	Max	Default	Description
Black Box	PF Status	3rd PF Status 16–32	H2	0x0000	0xFFFF	0	Bit 16: SDM—Shutdown activated by <i>ManufacturerAccess()</i> 0 = Inactive 1 = Active Bit 17: SHIPM—SHIP mode activated with <i>ManufacturerAccess()</i> 0 = Inactive 1 = Active Bit 18: AUTH—Authentication ongoing 0 = Inactive 1 = Active Bit 19: AWD—AFE Watchdog failure 0 = Inactive 1 = Active Bit 20: FVS—Fast Voltage Sampling 0 = Inactive 1 = Active Bit 21: CALO—Raw ADC/CC offset output 0 = Inactive 1 = Active Bit 22: SDV—Shutdown activated by voltage 0 = Inactive 1 = Active Bit 23: SLEEPM—Sleep mode active by <i>ManufacturerAccess()</i> 0 = Inactive 1 = Active Bit 24: INIT—Initialization after full reset, cleared when SBS data calculated and available 0 = Inactive 1 = Active Bit 25: SMBCAL—CC auto offset calibration ongoing after SBS line goes low 0 = Inactive 1 = Active Bit 26: SLEEPQMax—QMax update in Sleep mode 0 = Inactive 1 = Active Bit 27: SLEEPCC—Checking current in Sleep mode 0 = Inactive 1 = Active Bit 28: GPOD—GPOD pin status 0 = Inactive (high) 1 = Active (low) Bit 29: Reserved Bit 30: Reserved Bit 31: Reserved
Black Box	PF Status	3rd Time to Next Event	U1	0	255	0	Time since 3rd event

12.16 Calibration

12.16.1 Voltage

Class	Subclass	Name	Type	Min	Max	Default	Description
Calibration	Voltage	Cell Scale 0	I2	-32768	32767	20451	VC1-VSS Cell 0 gain
Calibration	Voltage	Cell Scale 1	I2	-32768	32767	20468	VC2-VC1 Cell 1 gain
Calibration	Voltage	Cell Scale 2	I2	-32768	32767	20520	VC3-VC2 Cell 2 gain
Calibration	Voltage	Cell Scale 3	I2	-32768	32767	20517	VC4-VC3 Cell 3 gain
Calibration	Voltage	Pack Gain	I2	-32768	32767	44100	PACK-VSS gain
Calibration	Voltage	Battery Gain	I2	-32768	32767	44100	VC4-VSS gain

12.16.2 Current

Class	Subclass	Name	Type	Min	Max	Default	Description
Calibration	Current	CC Gain	F4	1.00E-001	4.00E+000	0.9419	Coulomb Counter Gain
Calibration	Current	Capacity Gain	F4	2.98E+004	1.19E+006	280932.625	Capacity Gain

12.16.3 Current Offset

Class	Subclass	Name	Type	Min	Max	Default	Description
Calibration	Current Offset	CC Offset	I2	-32768	32767	-7204	Coulomb Counter Offset
Calibration	Current Offset	Coulomb Counter Offset Samples	U2	0	65535	64	Coulomb Counter Offset Samples used for averaging
Calibration	Current Offset	Board Offset	I2	-32768	32767	0	PCB board offset

12.16.4 Temperature

Class	Subclass	Name	Type	Min	Max	Default	Unit	Description
Calibration	Temperature	Internal Temp Offset	I1	-128	127	0	0.1°C	Internal temperature sensor reading offset
Calibration	Temperature	External 1 Temp Offset	I1	-128	127	0	0.1°C	TS1 temperature sensor reading offset
Calibration	Temperature	External 2 Temp Offset	I1	-128	127	0	0.1°C	TS2 temperature sensor reading offset
Calibration	Temperature	External 3 Temp Offset	I1	-128	127	0	0.1°C	TS3 temperature sensor reading offset
Calibration	Temperature	External 4 Temp Offset	I1	-128	127	0	0.1°C	TS4 temperature sensor reading offset

12.16.5 Internal Temp Model

Class	Subclass	Name	Type	Min	Max	Default	Description
Calibration	Internal Temp Model	Int Coeff 1	I2	-32768	32768	0	Internal temperature calculation polynomial value 1
Calibration	Internal Temp Model	Int Coeff 2	I2	-32768	32768	0	Internal temperature calculation polynomial value 2
Calibration	Internal Temp Model	Int Coeff 3	I2	-32768	32768	-11136	Internal temperature calculation polynomial value 3
Calibration	Internal Temp Model	Int Coeff 4	I2	-32768	32768	5754	Internal temperature calculation polynomial value 4

Class	Subclass	Name	Type	Min	Max	Default	Description
Calibration	Internal Temp Model	Int Minimum AD	I2	-32768	32768	0	Minimum AD count used for calculation
Calibration	Internal Temp Model	Int Maximum Temp	I2	-32768	32768	5754	Maximum Temperature boundary

12.16.6 Cell Temp Model

Class	Subclass	Name	Type	Min	Max	Default	Description
Calibration	Cell Temp Model	Coefficient a1	I2	-32768	32768	-14520	Cell Temperature calculation polynomial a1
Calibration	Cell Temp Model	Coefficient a2	I2	-32768	32768	23696	Cell Temperature calculation polynomial a2
Calibration	Cell Temp Model	Coefficient a3	I2	-32768	32768	-20298	Cell Temperature calculation polynomial a3
Calibration	Cell Temp Model	Coefficient a4	I2	-32768	32768	28073	Cell Temperature calculation polynomial a4
Calibration	Cell Temp Model	Coefficient a5	I2	-32768	32768	865	Cell Temperature calculation polynomial a5
Calibration	Cell Temp Model	Coefficient b1	I2	-32768	32768	-694	Cell Temperature calculation polynomial b1
Calibration	Cell Temp Model	Coefficient b2	I2	-32768	32768	1326	Cell Temperature calculation polynomial b2
Calibration	Cell Temp Model	Coefficient b3	I2	-32768	32768	-3880	Cell Temperature calculation polynomial b3
Calibration	Cell Temp Model	Coefficient b4	I2	-32768	32768	5127	Cell Temperature calculation polynomial b4
Calibration	Cell Temp Model	Rc0	I2	-32768	32768	11703	Resistance at 25°C
Calibration	Cell Temp Model	Adc0	I2	-32768	32768	11703	ADC reading at 25°C
Calibration	Cell Temp Model	Rpad	I2	-32768	32768	0	Pad Resistance
Calibration	Cell Temp Model	Rint	I2	-32768	32768	0	Pull up resistor resistance

12.16.7 FET Temp Model

Class	Subclass	Name	Type	Min	Max	Default	Description
Calibration	FET Temp Model	Coefficient a1	I2	-32768	32768	-14520	FET Temperature calculation polynomial a1
Calibration	FET Temp Model	Coefficient a2	I2	-32768	32768	23696	FET Temperature calculation polynomial a2
Calibration	FET Temp Model	Coefficient a3	I2	-32768	32768	-20298	FET Temperature calculation polynomial a3
Calibration	FET Temp Model	Coefficient a4	I2	-32768	32768	28073	FET Temperature calculation polynomial a4
Calibration	FET Temp Model	Coefficient a5	I2	-32768	32768	865	FET Temperature calculation polynomial a5
Calibration	FET Temp Model	Coefficient b1	I2	-32768	32768	-694	FET Temperature calculation polynomial b1
Calibration	FET Temp Model	Coefficient b2	I2	-32768	32768	1326	FET Temperature calculation polynomial b2
Calibration	FET Temp Model	Coefficient b3	I2	-32768	32768	-3880	FET Temperature calculation polynomial b3
Calibration	FET Temp Model	Coefficient b4	I2	-32768	32768	5127	FET Temperature calculation polynomial b4
Calibration	FET Temp Model	Rc0	I2	-32768	32768	11703	Resistance at 25°C

Class	Subclass	Name	Type	Min	Max	Default	Description
Calibration	FET Temp Model	Adc0	I2	-32768	32768	11703	ADC reading at 25°C
Calibration	FET Temp Model	Rpad	I2	-32768	32768	0	Pad Resistance
Calibration	FET Temp Model	Rint	I2	-32768	32768	0	Pull up resistor resistance

12.16.8 Filter

Class	Subclass	Name	Type	Min	Max	Default	Description
Calibration	Filter	Cell Voltage 1	U1	0	255	145	Low pass filter settings for averaging, sample setting values and associated low-pass filter time constants are in Table C-2 . Chosen filter settings will have an effect on protection delays. Higher filter values will cause voltages and temperature to take longer to respond to stimulus to reach threshold, for example. A filter value of 50 closely matches the behavior of previous gas gauges.
Calibration	Filter	Cell Voltage 2	U1	0	255	145	
Calibration	Filter	Cell Voltage 3	U1	0	255	145	
Calibration	Filter	Cell Voltage 4	U1	0	255	145	
Calibration	Filter	Pack Voltage Out	U1	0	255	10	
Calibration	Filter	Direct Battery Voltage	U1	0	255	10	
Calibration	Filter	Summed Battery Voltage	U1	0	255	145	
Calibration	Filter	Cell Temperature	U1	0	255	145	
Calibration	Filter	FET Temperature	U1	0	255	145	

12.16.9 Current Deadband

Class	Subclass	Name	Type	Min	Max	Default	Unit	Description
Calibration	Current Deadband	Deadband	U1	0	255	3	mA	Deadband to report 0 mA
Calibration	Current Deadband	Coulomb Counter Deadband	U1	0	255	34	μV	Coulomb counter deadband to report 0 charge

AFE Threshold and Delay Settings

A.1 Overload in Discharge Protection (OLD)

Table A-1. Overload in Discharge Protection Threshold (Settings:AFE State Control [RSNS] = 0)

OLD Threshold ([RSNS] = 0)			
Setting	Threshold	Setting	Threshold
0x00	0.050 V	0x08	0.130 V
0x01	0.060 V	0x09	0.140 V
0x02	0.070 V	0x0A	0.150 V
0x03	0.080 V	0x0B	0.160 V
0x04	0.090 V	0x0C	0.170 V
0x05	0.100 V	0x0D	0.180 V
0x06	0.110 V	0x0E	0.190 V
0x07	0.120 V	0x0F	0.200 V

Table A-2. Overload in Discharge Protection Threshold (Settings:AFE State Control [RSNS] = 1)

OLD Threshold ([RSNS] = 1)			
Setting	Threshold	Setting	Threshold
0x00	0.025 V	0x08	0.065 V
0x01	0.030 V	0x09	0.070 V
0x02	0.035 V	0x0A	0.075 V
0x03	0.040 V	0x0B	0.080 V
0x04	0.045 V	0x0C	0.085 V
0x05	0.050 V	0x0D	0.090 V
0x06	0.055 V	0x0E	0.095 V
0x07	0.060 V	0x0F	0.100 V

Table A-3. Overload in Discharge Protection Delay

Setting	Time	Setting	Time	Setting	Time	Setting	Time
0x00	1 ms	0x04	9 ms	0x08	17 ms	0x0C	25 ms
0x01	3 ms	0x05	11 ms	0x09	19 ms	0x0D	27 ms
0x02	5 ms	0x06	13 ms	0x0A	21 ms	0x0E	29 ms
0x03	7 ms	0x07	15 ms	0x0B	23 ms	0x0F	31 ms

A.2 Short Circuit in Charge (SCC)

Table A-4. Short Circuit in Charge Threshold (Settings:AFE State Control [RSNS] = 0)⁽¹⁾

Setting	Threshold	Setting	Threshold
0x00	-0.100 V	0x04	-0.300 V
0x01	-0.150 V	0x05	N/A
0x02	-0.200 V	0x06	N/A
0x03	-0.250 V	0x07	N/A

⁽¹⁾ Data flash setting Protection:SCC Threshold[2:0] sets the voltage threshold.

Table A-5. Short Circuit in Charge Threshold (Settings:AFE State Control [RSNS] = 1)⁽¹⁾

Setting	Threshold	Setting	Threshold
0x00	-0.050 V	0x04	-0.150 V
0x01	-0.075 V	0x05	-0.175 V
0x02	-0.100 V	0x06	-0.200 V
0x03	-0.125 V	0x07	-0.225 V

⁽¹⁾ Data flash setting Protection:SCC Threshold[2:0] sets the voltage threshold.

Table A-6. Short Circuit in Charge Delay⁽¹⁾

Setting	Time	Setting	Time	Setting	Time	Setting	Time
0x00	0 μ s	0x04	244 μ s	0x08	488 μ s	0x0C	732 μ s
0x01	61 μ s	0x05	305 μ s	0x09	549 μ s	0x0D	793 μ s
0x02	122 μ s	0x06	366 μ s	0x0A	610 μ s	0x0E	854 μ s
0x03	183 μ s	0x07	427 μ s	0x0B	671 μ s	0x0F	915 μ s

⁽¹⁾ Data flash setting Protection:SCC Threshold[7:4] sets the delay time.

A.3 Short Circuit in Discharge (SCD1 and SCD2)

Table A-7. Short Circuit in Discharge Threshold (Settings:AFE State Control [RSNS] = 0)⁽¹⁾

Setting	Threshold	Setting	Threshold
0x00	0.100 V	0x04	0.300 V
0x01	0.150 V	0x05	0.350 V
0x02	0.200 V	0x06	0.400 V
0x03	0.250 V	0x07	0.450 V

⁽¹⁾ Data flash setting Protection:SCD1 and SCD2 Threshold[2:0] sets the voltage threshold.

Table A-8. Short Circuit in Discharge Threshold (Settings:AFE State Control[RSNS] = 1)⁽¹⁾

Setting	Threshold	Setting	Threshold
0x00	0.050 V	0x04	0.150 V
0x01	0.075 V	0x05	0.175 V
0x02	0.100 V	0x06	0.200 V

⁽¹⁾ Data flash setting Protection:SCD1 and SCD2 Threshold[2:0] sets the voltage threshold.

Table A-9. Short Circuit in Discharge 1 Delay (Settings:AFE State Control[SCDDx2] = 0)⁽¹⁾

Setting	Time	Setting	Time	Setting	Time	Setting	Time
0x00	0 μ s	0x04	244 μ s	0x08	488 μ s	0x0C	732 μ s

⁽¹⁾ Data flash setting Protection:SCD1 and SCD2 Threshold[7:4] sets the delay time.

Table A-9. Short Circuit in Discharge 1 Delay (Settings:AFE State Control[SCDDx2] = 0)⁽¹⁾ (continued)

Setting	Time	Setting	Time	Setting	Time	Setting	Time
0x01	61 μ s	0x05	305 μ s	0x09	549 μ s	0x0D	793 μ s
0x02	122 μ s	0x06	366 μ s	0x0A	610 μ s	0x0E	854 μ s
0x03	183 μ s	0x07	427 μ s	0x0B	671 μ s	0x0F	915 μ s

Table A-10. Short Circuit in Discharge 1 Delay (Settings:AFE State Control[SCDDx2] = 1)⁽¹⁾

Setting	Time	Setting	Time	Setting	Time	Setting	Time
0x00	0 μ s	0x04	488 μ s	0x08	976 μ s	0x0C	1464 μ s
0x01	122 μ s	0x05	610 μ s	0x09	1098 μ s	0x0D	1586 μ s
0x02	244 μ s	0x06	732 μ s	0x0A	1220 μ s	0x0E	1708 μ s
0x03	366 μ s	0x07	854 μ s	0x0B	1342 μ s	0x0F	1830 μ s

⁽¹⁾ Data flash setting Protection:SCD1 Threshold[7:4] sets the delay time.

Table A-11. Short Circuit in Discharge 2 Delay (Settings:AFE State Control[SCDDx2] = 0)⁽¹⁾

Setting	Time	Setting	Time	Setting	Time	Setting	Time
0x00	0 μ s	0x04	122 μ s	0x08	244 μ s	0x0C	366 μ s
0x01	30 μ s	0x05	152 μ s	0x09	275 μ s	0x0D	396 μ s
0x02	61 μ s	0x06	183 μ s	0x0A	305 μ s	0x0E	426 μ s
0x03	91 μ s	0x07	213 μ s	0x0B	335 μ s	0x0F	458 μ s

⁽¹⁾ Data flash setting Protection: SCD2 Threshold[7:4] sets the delay time.

Table A-12. Short Circuit in Discharge 2 Delay (Settings:AFE State Control[SCDDx2] = 1)⁽¹⁾

Setting	Time	Setting	Time	Setting	Time	Setting	Time
0x00	0 μ s	0x04	244 μ s	0x08	488 μ s	0x0C	732 μ s
0x01	61 μ s	0x05	305 μ s	0x09	549 μ s	0x0D	793 μ s
0x02	122 μ s	0x06	366 μ s	0x0A	610 μ s	0x0E	854 μ s
0x03	183 μ s	0x07	427 μ s	0x0B	671 μ s	0x0F	915 μ s

⁽¹⁾ Data flash setting Protection: SCD2 Threshold[7:4] sets the delay time.

Reading and Writing to Data Flash

Use *ManufacturerAccess()* 0x01yy and *ManufacturerInput()* 0x2f to read and right to data flash, which is a 32-byte operation. First, determine the physical address of the target data flash parameter. This information is reflected by the subclass ID and offset, available in [Table B-1](#) and [Table B-2](#).

Below is an example of updating data flash setting Protections:*CUV Recovery*

Subclass ID of Protections:*CUV Recovery* = 235

Offset of Protections:*CUV Recovery* = 3.

Data Type = I2.

1. Identify the data flash row number and byte index:
 - (a) Identify the physical address of the target parameter.
The physical address of Protections:*CUV Recovery* = Subclass ID + Offset = 238.
 - (b) Find the row number of Protections:*CUV Recovery*.
Each data flash row is 32-byte long.
Row number of Protections:*CUV Recovery* = $238 \div 32 = 7$.
 - (c) Find out which byte(s) the target parameter is resided at with the row.
Byte Index = Physical location—(row number × row length).
Byte Index for Protections:*CUV Recovery* = $238 - (7 \times 32) = 14$.
Since the data type of Protections:*CUV Recovery* is I2, this means the target parameter is resided at row 7, byte index 14 and 15.
2. Read data flash parameter:
 - (a) Send the data flash row number to bq30z50-R1/55 using MAC command 0x1yy.
From step A2, the row number of *CUV Recovery* is 7.
Issue SMBus write word. cmd = 0x00, word = 0x107.
Note: the row number issue through command 0x1yy must be in Hex.
 - (b) Use *ManufacturerInput()* 0x2f to read the data flash row where the target parameter is located.
Issue SMBus block read, cmd = 0x2f, length = 32.
Note: Store the read data into a memory array; for example, yRowdataArray(0 to 31).
 - (c) Data flash parameter Protections:*CUV Recovery* is located at yRowDataArrray(14) and yRowDataArrray(15).
3. Update data flash parameter.
 - (a) From step B3, update the desire value of the target data flash parameter.
 - (b) Follow step B1 to set up the row number.
 - (c) Use *ManufacturerInput()* 0x2f to write the updated yRowdataArray(0 to 31) back to the device data flash.
Issue SMBus block write, cmd = 0x2f, length = 32.
 - (d) A read verify (repeat step B1 to B3) is recommend to ensure correct data is written to the data flash.

Table B-1. bq30z50-R1 Data Flash Subclass ID and Offset (Firmware v0.33)

Class	Subclass ID	Subclass	Offset	Name	Data Type	Min	Max	Default Value	Units
Protections	279	CUV							

Table B-1. bq30z50-R1 Data Flash Subclass ID and Offset (Firmware v0.33) (continued)

Class	Subclass ID	Subclass	Offset	Name	Data Type	Min	Max	Default Value	Units
			0	Threshold	I2	0	32767	2800	mV
			2	Delay	U1	0	255	2	s
			3	Recovery	I2	0	32767	3000	mV
Protections	284	CUVC							
			0	Threshold	I2	0	32767	2900	mV
			2	Delay	U1	0	255	2	s
			3	Recovery	I2	0	32767	3000	mV
Protections	289	COV							
			0	Threshold Low Temp	I2	0	32767	4250	mV
			2	Threshold Standard Temp	I2	0	32767	4250	mV
			4	Threshold High Temp	I2	0	32767	4250	mV
			6	Threshold Rec Temp	I2	0	32767	4250	mV
			8	Delay	U1	0	255	2	s
			9	Recovery Low Temp	I2	0	32767	4150	mV
			11	Recovery Standard Temp	I2	0	32767	4150	mV
			13	Recovery High Temp	I2	0	32767	4150	mV
			15	Recovery Rec Temp	I2	0	32767	4150	mV
Protections	306	OCC1							
			0	Threshold	I2	-32768	32767	6000	mA
			2	Delay	U1	0	255	6	s
Protections	309	OCC2							
			0	Threshold	I2	-32768	32767	8000	mA
			2	Delay	U1	0	255	3	s
Protections	312	OCC							
			0	Recovery Threshold	I2	-32768	32767	-50	mA
			2	Recovery Delay	U1	0	255	5	s
Protections	315	OCD1							
			0	Threshold	I2	-32768	32767	-6000	mA
			2	Delay	U1	0	255	6	s
Protections	318	OCD2							
			0	Threshold	I2	-32768	32767	-8000	mA
			2	Delay	U1	0	255	3	s
Protections	321	OCD							
			0	Recovery Threshold	I2	-32768	32767	50	mA
			2	Recovery Delay	U1	0	255	5	s
Protections	324	OLD							
			0	Threshold	H1	0	0F	09	—
			1	Delay	H1	0	0F	0F	—
			2	Latch Limit	U1	0	255	0	—
			3	Counter Dec Delay	U1	0	255	10	s
			4	Recovery	U1	0	255	5	s
			5	Reset	U1	0	255	15	s
Protections	330	SCC							

Table B-1. bq30z50-R1 Data Flash Subclass ID and Offset (Firmware v0.33) (continued)

Class	Subclass ID	Subclass	Offset	Name	Data Type	Min	Max	Default Value	Units
			0	Threshold	H1	0	ff	77	—
			1	Latch Limit	U1	0	255	0	mA
			2	Counter Dec Delay	U1	0	255	10	s
			3	Recovery	U1	0	255	5	s
			4	Reset	U1	0	255	15	s
Protections	335	SCD1							
			0	Threshold	H1	0	ff	77	—
Protections	336	SCD2							
			0	Threshold	H1	0	ff	e7	—
Protections	337	SCD							
			0	Latch Limit	U1	0	255	0	mA
			1	Counter Dec Delay	U1	0	255	10	s
			2	Recovery	U1	0	255	5	s
			3	Reset	U1	0	255	15	s
Protections	341	OTC							
			0	Threshold	I2	−400	1500	550	1°C
			2	Delay	U1	0	255	2	s
			3	Recovery	I2	−400	1500	500	1°C
Protections	346	OTD							
			0	Threshold	I2	−400	1500	600	1°C
			2	Delay	U1	0	255	2	s
			3	Recovery	I2	−400	1500	550	1°C
Protections	351	OTF							
			0	Threshold	I2	−400	1500	800	1°C
			2	Delay	U1	0	255	2	s
			3	Recovery	I2	−400	1500	650	1°C
Protections	356	HWD							
			0	Delay	U1	0	255	10	s
Protections	357	PTO							
			0	Charge Threshold	I2	−32768	32767	2000	mA
			2	Suspend Threshold	I2	−32768	32767	1800	mA
			4	Delay	U2	0	65535	1800	s
			6	Reset	I2	0	32767	2	mAh
Protections	365	CTO							
			0	Charge Threshold	I2	−32768	32767	2500	mA
			2	Suspend Threshold	I2	−32768	32767	2000	mA
			4	Delay	U2	0	65535	54000	s
			6	Reset	I2	0	32767	2	mAh
Protections	373	OC							
			0	Threshold	I2	−32768	32767	300	mAh
			2	Recovery	I2	−32768	32767	2	mAh
			4	RSOC Recovery	U1	0	100	90	%
Protections	378	CHGV							
			0	Threshold	I2	−32768	32767	500	mV
			2	Delay	U1	0	255	30	s
			3	Recovery	I2	−32768	32767	−500	mV

Table B-1. bq30z50-R1 Data Flash Subclass ID and Offset (Firmware v0.33) (continued)

Class	Subclass ID	Subclass	Offset	Name	Data Type	Min	Max	Default Value	Units
Protections	383	CHGC	0	Threshold	I2	-32768	32767	500	mA
			2	Delay	U1	0	255	2	s
			3	Recovery	I2	-32768	32767	100	mA
Permanent Fail	388	CUV	0	Threshold	I2	0	32767	2500	mV
			2	Delay	U1	0	255	2	s
			391	COV	0	Threshold	I2	0	32767
			2	Delay	U1	0	255	2	s
Permanent Fail	394	CUDEP	0	Threshold	I2	0	32767	2500	mV
			2	Delay	U1	0	255	2	s
			Permanent Fail	397	OTCE	0	Threshold	I2	-400
2	Delay	U1				0	255	2	s
Permanent Fail	400	OTF				0	Threshold	I2	-400
			2	Delay	U1	0	255	2	s
			Permanent Fail	403	QIM	0	Delta Threshold	I2	0
2	Delay	U1				0	255	2	updates
Permanent Fail	406	CB				0	Max Threshold	I2	0
			2	Delta Threshold	U1	0	255	20	h
			3	Delay	U1	0	255	2	cycles
Permanent Fail	410	VIMR	0	Check Voltage	I2	0	5000	3600	mV
			2	Check Current	I2	0	32767	10	mA
			4	Delta Threshold	I2	0	5000	200	mV
			6	Delta Delay	U1	0	255	2	s
			7	Duration	U2	0	65535	100	s
Permanent Fail	419	VIMA	0	Check Voltage	I2	0	5000	3600	mV
			2	Check Current	I2	0	32767	10	mA
			4	Delta Threshold	I2	0	5000	300	mV
			6	Delay	U1	0	255	2	s
Permanent Fail	426	IMP	0	Delta Threshold	I2	0	32767	300	%
			2	Max Threshold	I2	0	32767	400	%
			4	Ra Update Counts	U1	0	255	2	counts
Permanent Fail	431	CD	0	Threshold	I2	0	32767	4200	mAh
			2	Delay	U1	0	255	2	cycles
Permanent Fail	434	CFETF	0	OFF Threshold	I2	0	500	5	mA
			2	OFF Delay	U1	0	255	2	s
Permanent Fail	437	DFET	0	OFF Threshold	I2	-500	0	-5	mA
			2	OFF Delay	U1	0	255	2	s

Table B-1. bq30z50-R1 Data Flash Subclass ID and Offset (Firmware v0.33) (continued)

Class	Subclass ID	Subclass	Offset	Name	Data Type	Min	Max	Default Value	Units
Permanent Fail	440	TH							
			4	ADC Delay	U1	0	255	10	s
Permanent Fail	445	FUSE							
			0	Threshold	I2	0	255	5	mA
			2	Delay	U1	0	255	2	s
Permanent Fail	448	AFER							
			0	Threshold	U1	0	255	100	—
			1	Delay Period	U1	0	255	2	s
			2	Compare Period	U1	0	255	5	s
Permanent Fail	451	AFEC							
			0	Threshold	U1	0	255	100	—
			1	Delay Period	U1	0	255	5	s
Permanent Fail	453	2LVL							
			0	Delay	U1	0	255	2	s
Permanent Fail	454	OCECO							
			0	Threshold	I2	0	32767	5000	mV
			2	Delay	U1	0	255	2	s
Advanced Charge Algorithm	111	Temperature Ranges							
			0	T1 Temp	I1	-128	127	0	°C
			1	T2 Temp	I1	-128	127	12	°C
			2	T5 Temp	I1	-128	127	20	°C
			3	T6 Temp	I1	-128	127	25	°C
			4	T3 Temp	I1	-128	127	30	°C
			5	T4 Temp	I1	-128	127	55	°C
			6	Hysteresis Temp	I1	-128	127	0	°C
Advanced Charge Algorithm	118	Low Temp Charging							
			0	Voltage	I2	0	32767	3000	mV
			2	Current Low	I2	0	32767	132	mA
			4	Current Med	I2	0	32767	352	mA
			6	Current High	I2	0	32767	264	mA
Advanced Charge Algorithm	126	Standard Temp Charging							
			0	Voltage	I2	0	32767	4200	mV
			2	Current Low	I2	0	32767	1980	mA
			4	Current Med	I2	0	32767	4004	mA
			6	Current High	I2	0	32767	2992	mA
Advanced Charge Algorithm	134	High Temp Charging							
			0	Voltage	I2	0	32767	4000	mV
			2	Current Low	I2	0	32767	1012	mA
			4	Current Med	I2	0	32767	1980	mA
			6	Current High	I2	0	32767	1496	mA
Advanced Charge Algorithm	142	Rec Temp Charging							
			0	Voltage	I2	0	32767	4100	mV
			2	Current Low	I2	0	32767	2508	mA

Table B-1. bq30z50-R1 Data Flash Subclass ID and Offset (Firmware v0.33) (continued)

Class	Subclass ID	Subclass	Offset	Name	Data Type	Min	Max	Default Value	Units
			4	Current Med	I2	0	32767	4488	mA
			6	Current High	I2	0	32767	3520	mA
Advanced Charge Algorithm	150	Pre-Charging							
			0	Current	I2	0	32767	88	mA
Advanced Charge Algorithm	152	Maintenance Charging							
			0	Current	I2	0	32767	44	mA
Advanced Charge Algorithm	154	Voltage Range							
			0	Charging Voltage Low	I2	0	32767	2500	mV
			2	Charging Voltage Med	I2	0	32767	3600	mV
			4	Charging Voltage High	I2	0	32767	4000	mV
			6	Charging Voltage Hysteresis	U1	0	255	0	mV
Advanced Charge Algorithm	161	Termination Config							
			0	Charge Term Taper Current	I2	0	32767	250	mA
			4	Charge Term Voltage	I2	0	32767	75	mV
Advanced Charge Algorithm	170	Cell Balancing Config							
			0	Bal Time/mAh Cell 0	U2	0	65535	367	s/mAh
			2	Bal Time/mAh Cell 1-3	U2	0	65535	514	s/mAh
			4	Min Start Balance Delta	U1	0	255	3	mV
			5	Relax Balance Interval	U4	0	4294967295	18000	s
			9	Min Rsoc for Balancing	U1	0	100	80	%
Advanced Charge Algorithm	180	Charging Rate of Change							
			0	Current Rate	U1	1	255	1	steps
			1	Voltage Rate	U1	1	255	1	steps
Advanced Charge Algorithm	182	Charge Loss Compensation							
			0	CCC Current Threshold	I2	0	32767	3520	mA
			2	CCC Voltage Threshold	I2	0	32767	4200	mV
System Data	640	Manufacturer Data							
			0	Manufacturer Info	S33	x	x	abcdefghijklmno pqrstuvwxyz012 345	—
System Data	673	Integrity							
			4	Data Flash Checksum	H2	0	ffff	0	—

Table B-1. bq30z50-R1 Data Flash Subclass ID and Offset (Firmware v0.33) (continued)

Class	Subclass ID	Subclass	Offset	Name	Data Type	Min	Max	Default Value	Units
SBS Configuration	679	Data							
			0	Remaining AH Cap. Alarm	I2	0	32767	300	mAh
			2	Remaining WH Cap. Alarm	I2	0	32767	432	cWh
			4	Remaining Time Alarm	U2	0	65535	10	min
			6	Initial Battery Mode	H2	0	fff	81	—
			8	Design Voltage	I2	0	32767	14400	mV
			10	Specification Information	H2	0	fff	31	—
			12	Manufacture Date	U2	0	65535	0	date
			14	Serial Number	H2	0	fff	1	—
			16	Cycle Count	U2	0	65535	0	—
			18	Cycle Count Percentage	U1	0	100	90	%
			19	Max Error Limit	U1	0	100	100	%
			20	Design Capacity mAh	I2	0	32767	4400	mAh
			22	Design Capacity cWh	I2	0	32767	6336	cWh
			24	Manufacturer Name	S21	x	x	Texas Instruments	—
			45	Device Name	S21	x	x	bq30z50-R1	—
			66	Device Chemistry	S5	x	x	LION	—
SBS Configuration	750	FD							
			0	Set Voltage Threshold	I2	0	5000	3000	mV
			2	Clear Voltage Threshold	I2	0	5000	3100	mV
			4	Set % RSOC Threshold	U1	0	100	0	%
			5	Clear % RSOC Threshold	U1	0	100	5	%
SBS Configuration	756	FC							
			0	Set Voltage Threshold	I2	0	5000	4200	mV
			2	Clear Voltage Threshold	I2	0	5000	4100	mV
			4	Set % RSOC Threshold	U1	0	100	100	%
			5	Clear % RSOC Threshold	U1	0	100	95	%
SBS Configuration	762	TDA							
			0	Set Voltage Threshold	I2	0	5000	3200	mV
			2	Clear Voltage Threshold	I2	0	5000	3300	mV
			4	Set % RSOC Threshold	U1	0	100	10	%
			5	Clear % RSOC Threshold	U1	0	100	15	%

Table B-1. bq30z50-R1 Data Flash Subclass ID and Offset (Firmware v0.33) (continued)

Class	Subclass ID	Subclass	Offset	Name	Data Type	Min	Max	Default Value	Units
SBS Configuration	768	TCA							
			0	Set Voltage Threshold	I2	0	5000	4200	mV
			2	Clear Voltage Threshold	I2	0	5000	4100	mV
			4	Set % RSOC Threshold	U1	0	100	100	%
			5	Clear % RSOC Threshold	U1	0	100	95	%
SBS Configuration	774	Max Error							
			3	Time Cycle Equivalent	U1	0	255	12	h
			4	Cycle Delta	U1	0	255	5	%
Lifetimes	512	Voltage							
			0	Max Cell Voltage 0	U1	0	255	0	mV
			1	Max Cell Voltage 1	U1	0	255	0	mV
			2	Max Cell Voltage 2	U1	0	255	0	mV
			3	Max Cell Voltage 3	U1	0	255	0	mV
			4	Min Cell Voltage 0	U1	0	255	255	mV
			5	Min Cell Voltage 1	U1	0	255	255	mV
			6	Min Cell Voltage 2	U1	0	255	255	mV
			7	Min Cell Voltage 3	U1	0	255	255	mV
			8	Max Delta Cell Voltage	U1	0	255	0	mV
Lifetimes	521	Current							
			0	Max Charge Current	U1	0	255	0	mA
			1	Max Discharge Current	U1	0	255	0	mA
			2	Max Avg Dsg Current	U1	0	255	0	mA
			3	Max Avg Dsg Power	U1	0	255	0	W
Lifetimes	525	Safety Events							
			0	No Of Cov Events	U1	0	255	0	events
			1	Last Cov Event	U1	0	255	0	cycles
			2	No Of Cuv Events	U1	0	255	0	events
			3	Last Cuv Event	U1	0	255	0	cycles
			4	No Of Ocd1 Events	U1	0	255	0	events
			5	Last Ocd1 Event	U1	0	255	0	cycles
			6	No Of Ocd2 Events	U1	0	255	0	events
			7	Last Ocd2 Event	U1	0	255	0	cycles
			8	No Of Occ1 Events	U1	0	255	0	events

Table B-1. bq30z50-R1 Data Flash Subclass ID and Offset (Firmware v0.33) (continued)

Class	Subclass ID	Subclass	Offset	Name	Data Type	Min	Max	Default Value	Units
			9	Last Occ1 Event	U1	0	255	0	cycles
			10	No Of Occ2 Events	U1	0	255	0	events
			11	Last Occ2 Event	U1	0	255	0	cycles
			12	No Of Old Events	U1	0	255	0	events
			13	Last Old Event	U1	0	255	0	cycles
			14	No Of Scd Events	U1	0	255	0	events
			15	Last Scd Event	U1	0	255	0	cycles
			16	No Of Scc Events	U1	0	255	0	events
			17	Last Scc Event	U1	0	255	0	cycles
			18	No Of Otc Events	U1	0	255	0	events
			19	Last Otc Event	U1	0	255	0	cycles
			20	No Of Otd Events	U1	0	255	0	events
			21	Last Otd Event	U1	0	255	0	cycles
			22	No Of Otf Events	U1	0	255	0	events
			23	Last Otf Event	U1	0	255	0	cycles
Lifetimes	549	Charging Events							
			0	No Valid Charge Term	U1	0	255	0	events
			1	Last Valid Charge Term	U1	0	255	0	cycles
Lifetimes	551	Gauging Events							
			0	No Of Qmax Updates	U1	0	255	0	events
			1	Last Qmax Update	U1	0	255	0	cycles
			2	No Of Ra Updates	U1	0	255	0	events
			3	Last Ra Update	U1	0	255	0	cycles
			4	No Of Ra Disable	U1	0	255	0	events
			5	Last Ra Disable	U1	0	255	0	cycles
Lifetimes	557	Power Events							
			0	No Of Shutdowns	U1	0	255	0	events
Lifetimes	561	Cell Balancing							
			0	Cb Time Cell 0	U1	0	255	0	h
			1	Cb Time Cell 1	U1	0	255	0	h
			2	Cb Time Cell 2	U1	0	255	0	h
			3	Cb Time Cell 3	U1	0	255	0	h
Lifetimes	565	Temperature							
			0	Max Temp Cell	I1	-128	127	-128	°C
			1	Min Temp Cell	I1	-128	127	127	°C
			2	Max Delta Cell Temp	I1	-128	127	0	°C
			3	Max Temp Int Sensor	I1	-128	127	-128	°C

Table B-1. bq30z50-R1 Data Flash Subclass ID and Offset (Firmware v0.33) (continued)

Class	Subclass ID	Subclass	Offset	Name	Data Type	Min	Max	Default Value	Units
			4	Min Temp Int Sensor	I1	-128	127	127	°C
			5	Max Temp Fet	I1	-128	127	-128	°C
Lifetimes	571	Time							
			0	Total Fw Runtime	U2	0	65535	0	h
			2	Time Spent In UT	U2	0	65535	0	h
			4	Time Spent In LT	U2	0	65535	0	h
			6	Time Spent In STL	U2	0	65535	0	h
			8	Time Spent In RT	U2	0	65535	0	h
			10	Time Spent In STH	U2	0	65535	0	h
			12	Time Spent In HT	U2	0	65535	0	h
			14	Time Spent In OT	U2	0	65535	0	h
Settings	187	Fuse							
			0	PF Fuse 0–15	H2	0	fff	0	—
			2	PF Fuse 16–31	H2	0	fff	0	—
			4	Min Blow Fuse Voltage	I2	0	65535	8000	mV
Settings	193	Manufacturing							
			0	Manufacturing Status	H2	0	fff	8000	—
Settings	195	Protection							
			0	Enabled Protections 0–15	H2	0	fff	fff	—
			2	Enabled Protections 16–31	H2	0	fff	fff	—
Settings	199	Permanent Failure							
			0	Enabled PF 0–15	H2	0	fff	fff	—
			2	Enabled PF 16–31	H2	0	fff	fff	—
Settings	203	Configuration							
			0	Protection Configuration	H1	0	ff	01	—
			1	Temperature Configuration	H2	0	fff	0087	—
			3	LED Configuration	H2	0	fff	00D0	—
			5	Charging Configuration	H1	0	ff	0	—
			6	System Configuration	H2	0	1ff	32	—
			8	Gauging Configuration	H2	0	fff	1fda	—
			10	Sbs Configuration	H1	0	ff	20	—
			11	Sbs Data Config. 0–15	H2	0	0fff	0Caf	—
			13	Sbs Data Config. 16–23	H1	0	ff	ff	—

Table B-1. bq30z50-R1 Data Flash Subclass ID and Offset (Firmware v0.33) (continued)

Class	Subclass ID	Subclass	Offset	Name	Data Type	Min	Max	Default Value	Units
Settings	217	AFE							
			1	AFE State Control	H1	0	ff	0	—
Power	232	Power							
			0	Valid Update Voltage	I2	0	32767	7500	mV
Power	234	Shutdown							
			0	Shutdown Voltage	I2	0	32767	1750	mV
			2	Shutdown Time	U1	0	255	10	s
			3	Charger Present Threshold	I2	0	32767	3000	mV
Power	239	Sleep							
			0	Sleep Current	I2	0	32767	10	mA
			7	Voltage Time	U1	0	255	5	s
			8	Current Time	U1	0	255	20	s
			9	Wake	H1	0	ff	0	—
Power	249	Ship							
			0	Delay	U1	0	255	5	s
			1	Current	I2	-250	250	10	mA
Gas Gauging	252	Current Thresholds							
			0	Dsg Current Threshold	I2	-32768	32767	100	mA
			2	Chg Current Threshold	I2	-32768	32767	50	mA
			4	Quit Current	I2	0	32767	10	mA
Gas Gauging	888	State							
			0	Qmax Cell 0	I2	0	32767	4400	mAh
			2	Qmax Cell 1	I2	0	32767	4400	mAh
			4	Qmax Cell 2	I2	0	32767	4400	mAh
			6	Qmax Cell 3	I2	0	32767	4400	mAh
			8	Qmax Pack	I2	0	32767	4400	mAh
			12	Update Status	H1	0	ff	0	—
			13	Cell 0 Chg Voltage at EoC	I2	0	32767	4200	mV
			15	Cell 1 Chg Voltage at EoC	I2	0	32767	4200	mV
			17	Cell 2 Chg Voltage at EoC	I2	0	32767	4200	mV
			19	Cell 3 Chg Voltage at EoC	I2	0	32767	4200	mV
			21	Current at EoC	I2	0	32767	250	mA
			23	Avg I Last Run	I2	-32768	32767	-2000	mA
			25	Avg P Last Run	I2	-32768	32767	-3022	cW
			27	Delta Voltage	I2	-32768	32767	0	mV
			33	Max Avg I Last Run	I2	-32768	32767	-2000	mA
			35	Max Avg P Last Run	I2	-32768	32767	-3022	cW
Gas Gauging	925	IT Cfg							
			0	Load Select	U1	0	255	7	—
			1	Load Mode	U1	0	255	0	—
			16	Ra Filter	U2	0	999	500	%

Table B-1. bq30z50-R1 Data Flash Subclass ID and Offset (Firmware v0.33) (continued)

Class	Subclass ID	Subclass	Offset	Name	Data Type	Min	Max	Default Value	Units
			19	Ra Max Delta	U1	0	255	15	%
			21	Design Resistance	I2	1	32767	42	mΩ
			23	Reference Grid	U1	0	14	4	—
			24	Resistance Parameter Filter	U2	1	65534	65142	—
			62	Term Voltage	I2	0	32767	9000	mV
			64	Term Voltage Delta	I2	0	32767	300	mV
			81	User Rate-mA	I2	-9000	0	0	mA
			83	User Rate-cW	I2	-32768	0	0	cW
			85	Reserve Cap-mAh	I2	0	9000	0	mAh
			87	Reserve Cap-cWh	I2	0	32000	0	cWh
			93	Remcap Smoothing Filter	U1	0	255	250	—
			94	Fast Scale Start SOC	U1	0	100	10	%
LED Support	260	LED Config							
			0	LED Flash Period	U2	0	65535	2048	488 μs
			2	LED Blink Period	U2	0	65535	4096	488 μs
			4	LED Delay	U2	0	65535	400	488 μs
			6	LED Hold Time	U1	0	15	16	s
			7	CHG Flash Alarm	I1	0	100	10	%
			8	CHG Thresh 1	I1	0	100	0	%
			9	CHG Thresh 2	I1	0	100	20	%
			10	CHG Thresh 3	I1	0	100	40	%
			11	CHG Thresh 4	I1	0	100	60	%
			12	CHG Thresh 5	I1	0	100	80	%
			13	DSG Flash Alarm	I1	0	100	10	%
			14	DSG Thresh 1	I1	0	100	0	%
			15	DSG Thresh 2	I1	0	100	20	%
			16	DSG Thresh 3	I1	0	100	40	%
			17	DSG Thresh 4	I1	0	100	60	%
			18	DSG Thresh 5	I1	0	100	80	%
Ra Table	1280	R_a0							
			0	Cell0 R_a flag	H2	0	ffff	ff55	—
			2	Cell0 R_a 0	I2	0	32767	182	2 ⁻¹⁰ Ω
			4	Cell0 R_a 1	I2	0	32767	177	2 ⁻¹⁰ Ω
			6	Cell0 R_a 2	I2	0	32767	175	2 ⁻¹⁰ Ω
			8	Cell0 R_a 3	I2	0	32767	167	2 ⁻¹⁰ Ω
			10	Cell0 R_a 4	I2	0	327672	166	2 ⁻¹⁰ Ω
			12	Cell0 R_a 5	I2	0	32767	182	2 ⁻¹⁰ Ω
			14	Cell0 R_a 6	I2	0	32767	194	2 ⁻¹⁰ Ω
			16	Cell0 R_a 7	I2	0	32767	203	2 ⁻¹⁰ Ω
			18	Cell0 R_a 8	I2	0	32767	213	2 ⁻¹⁰ Ω
			20	Cell0 R_a 9	I2	0	32767	223	2 ⁻¹⁰ Ω
			22	Cell0 R_a 10	I2	0	32767	233	2 ⁻¹⁰ Ω

Table B-1. bq30z50-R1 Data Flash Subclass ID and Offset (Firmware v0.33) (continued)

Class	Subclass ID	Subclass	Offset	Name	Data Type	Min	Max	Default Value	Units
			24	Cell0 R_a 11	I2	0	32767	241	2 ⁻¹⁰ Ω
			26	Cell0 R_a 12	I2	0	32767	250	2 ⁻¹⁰ Ω
			28	Cell0 R_a 13	I2	0	32767	254	2 ⁻¹⁰ Ω
			30	Cell0 R_a 14	I2	0	32767	1500	2 ⁻¹⁰ Ω
Ra Table	1344	R_a1							
			0	Cell1 R_a flag	H2	0	ffff	ff55	—
			2	Cell1 R_a 0	I2	0	32767	163	2 ⁻¹⁰ Ω
			4	Cell1 R_a 1	I2	0	32767	151	2 ⁻¹⁰ Ω
			6	Cell1 R_a 2	I2	0	32767	152	2 ⁻¹⁰ Ω
			8	Cell1 R_a 3	I2	0	32767	143	2 ⁻¹⁰ Ω
			10	Cell1 R_a 4	I2	0	32767	145	2 ⁻¹⁰ Ω
			12	Cell1 R_a 5	I2	0	32767	162	2 ⁻¹⁰ Ω
			14	Cell1 R_a 6	I2	0	32767	178	2 ⁻¹⁰ Ω
			16	Cell1 R_a 7	I2	0	32767	188	2 ⁻¹⁰ Ω
			18	Cell1 R_a 8	I2	0	32767	200	2 ⁻¹⁰ Ω
			20	Cell1 R_a 9	I2	0	32767	206	2 ⁻¹⁰ Ω
			22	Cell1 R_a 10	I2	0	32767	216	2 ⁻¹⁰ Ω
			24	Cell1 R_a 11	I2	0	32767	230	2 ⁻¹⁰ Ω
			26	Cell1 R_a 12	I2	0	32767	240	2 ⁻¹⁰ Ω
			28	Cell1 R_a 13	I2	0	32767	254	2 ⁻¹⁰ Ω
			30	Cell1 R_a 14	I2	0	32767	1500	2 ⁻¹⁰ Ω
Ra Table	1408	R_a2							
			0	Cell2 R_a flag	H2	0	ffff	ff55	—
			2	Cell2 R_a 0	I2	0	32767	157	2 ⁻¹⁰ Ω
			4	Cell2 R_a 1	I2	0	32767	147	2 ⁻¹⁰ Ω
			6	Cell2 R_a 2	I2	0	32767	146	2 ⁻¹⁰ Ω
			8	Cell2 R_a 3	I2	0	32767	138	2 ⁻¹⁰ Ω
			10	Cell2 R_a 4	I2	0	32767	139	2 ⁻¹⁰ Ω
			12	Cell2 R_a 5	I2	0	32767	156	2 ⁻¹⁰ Ω
			14	Cell2 R_a 6	I2	0	32767	172	2 ⁻¹⁰ Ω
			16	Cell2 R_a 7	I2	0	32767	184	2 ⁻¹⁰ Ω
			18	Cell2 R_a 8	I2	0	32767	195	2 ⁻¹⁰ Ω
			20	Cell2 R_a 9	I2	0	32767	204	2 ⁻¹⁰ Ω
			22	Cell2 R_a 10	I2	0	32767	214	2 ⁻¹⁰ Ω
			24	Cell2 R_a 11	I2	0	32767	226	2 ⁻¹⁰ Ω
			26	Cell2 R_a 12	I2	0	32767	240	2 ⁻¹⁰ Ω
			28	Cell2 R_a 13	I2	0	32767	254	2 ⁻¹⁰ Ω
			30	Cell2 R_a 14	I2	0	32767	1500	2 ⁻¹⁰ Ω
Ra Table	1472	R_a3							
			0	Cell3 R_a flag	H2	0	ffff	ff55	—
			2	Cell3 R_a 0	I2	0	32767	68	2 ⁻¹⁰ Ω
			4	Cell3 R_a 1	I2	0	32767	77	2 ⁻¹⁰ Ω
			6	Cell3 R_a 2	I2	0	32767	88	2 ⁻¹⁰ Ω
			8	Cell3 R_a 3	I2	0	32767	106	2 ⁻¹⁰ Ω
			10	Cell3 R_a 4	I2	0	32767	103	2 ⁻¹⁰ Ω
			12	Cell3 R_a 5	I2	0	32767	71	2 ⁻¹⁰ Ω
			14	Cell3 R_a 6	I2	0	32767	84	2 ⁻¹⁰ Ω

Table B-1. bq30z50-R1 Data Flash Subclass ID and Offset (Firmware v0.33) (continued)

Class	Subclass ID	Subclass	Offset	Name	Data Type	Min	Max	Default Value	Units
			16	Cell3 R_a 7	I2	0	32767	117	2 ⁻¹⁰ Ω
			18	Cell3 R_a 8	I2	0	32767	112	2 ⁻¹⁰ Ω
			20	Cell3 R_a 9	I2	0	32767	132	2 ⁻¹⁰ Ω
			22	Cell3 R_a 10	I2	0	32767	121	2 ⁻¹⁰ Ω
			24	Cell3 R_a 11	I2	0	32767	90	2 ⁻¹⁰ Ω
			26	Cell3 R_a 12	I2	0	32767	89	2 ⁻¹⁰ Ω
			28	Cell3 R_a 13	I2	0	32767	254	2 ⁻¹⁰ Ω
			30	Cell3 R_a 14	I2	0	32767	1500	2 ⁻¹⁰ Ω
Ra Table	1536	R_a0x							
			0	xCell0 R_a flag	H2	0	ffff	ffff	—
			2	xCell0 R_a 0	I2	0	32767	68	2 ⁻¹⁰ Ω
			4	xCell0 R_a 1	I2	0	32767	77	2 ⁻¹⁰ Ω
			6	xCell0 R_a 2	I2	0	32767	88	2 ⁻¹⁰ Ω
			8	xCell0 R_a 3	I2	0	32767	106	2 ⁻¹⁰ Ω
			10	xCell0 R_a 4	I2	0	32767	103	2 ⁻¹⁰ Ω
			12	xCell0 R_a 5	I2	0	32767	71	2 ⁻¹⁰ Ω
			14	xCell0 R_a 6	I2	0	32767	84	2 ⁻¹⁰ Ω
			16	xCell0 R_a 7	I2	0	32767	117	2 ⁻¹⁰ Ω
			18	xCell0 R_a 8	I2	0	32767	112	2 ⁻¹⁰ Ω
			20	xCell0 R_a 9	I2	0	32767	132	2 ⁻¹⁰ Ω
			22	xCell0 R_a 10	I2	0	32767	121	2 ⁻¹⁰ Ω
			24	xCell0 R_a 11	I2	0	32767	90	2 ⁻¹⁰ Ω
			26	xCell0 R_a 12	I2	0	32767	89	2 ⁻¹⁰ Ω
			28	xCell0 R_a 13	I2	0	32767	254	2 ⁻¹⁰ Ω
			30	xCell0 R_a 14	I2	0	32767	1500	2 ⁻¹⁰ Ω
Ra Table	1600	R_a1x							
			0	xCell1 R_a flag	H2	0	ffff	ffff	—
			2	xCell1 R_a 0	I2	0	32767	68	2 ⁻¹⁰ Ω
			4	xCell1 R_a 1	I2	0	32767	77	2 ⁻¹⁰ Ω
			6	xCell1 R_a 2	I2	0	32767	88	2 ⁻¹⁰ Ω
			8	xCell1 R_a 3	I2	0	32767	106	2 ⁻¹⁰ Ω
			10	xCell1 R_a 4	I2	0	32767	103	2 ⁻¹⁰ Ω
			12	xCell1 R_a 5	I2	0	32767	71	2 ⁻¹⁰ Ω
			14	xCell1 R_a 6	I2	0	32767	84	2 ⁻¹⁰ Ω
			16	xCell1 R_a 7	I2	0	32767	117	2 ⁻¹⁰ Ω
			18	xCell1 R_a 8	I2	0	32767	112	2 ⁻¹⁰ Ω
			20	xCell1 R_a 9	I2	0	32767	132	2 ⁻¹⁰ Ω
			22	xCell1 R_a 10	I2	0	32767	121	2 ⁻¹⁰ Ω
			24	xCell1 R_a 11	I2	0	32767	90	2 ⁻¹⁰ Ω
			26	xCell1 R_a 12	I2	0	32767	89	2 ⁻¹⁰ Ω
			28	xCell1 R_a 13	I2	0	32767	254	2 ⁻¹⁰ Ω
			30	xCell1 R_a 14	I2	0	32767	1500	2 ⁻¹⁰ Ω
Ra Table	1664	R_a2x							
			0	xCell2 R_a flag	H2	0	ffff	ffff	—
			2	xCell2 R_a 0	I2	0	32767	68	2 ⁻¹⁰ Ω
			4	xCell2 R_a 1	I2	0	32767	77	2 ⁻¹⁰ Ω
			6	xCell2 R_a 2	I2	0	32767	88	2 ⁻¹⁰ Ω

Table B-1. bq30z50-R1 Data Flash Subclass ID and Offset (Firmware v0.33) (continued)

Class	Subclass ID	Subclass	Offset	Name	Data Type	Min	Max	Default Value	Units
			8	xCell2 R_a 3	I2	0	32767	106	2 ⁻¹⁰ Ω
			10	xCell2 R_a 4	I2	0	32767	103	2 ⁻¹⁰ Ω
			12	xCell2 R_a 5	I2	0	32767	71	2 ⁻¹⁰ Ω
			14	xCell2 R_a 6	I2	0	32767	84	2 ⁻¹⁰ Ω
			16	xCell2 R_a 7	I2	0	32767	117	2 ⁻¹⁰ Ω
			18	xCell2 R_a 8	I2	0	32767	112	2 ⁻¹⁰ Ω
			20	xCell2 R_a 9	I2	0	32767	132	2 ⁻¹⁰ Ω
			22	xCell2 R_a 10	I2	0	32767	121	2 ⁻¹⁰ Ω
			24	xCell2 R_a 11	I2	0	32767	90	2 ⁻¹⁰ Ω
			26	xCell2 R_a 12	I2	0	32767	89	2 ⁻¹⁰ Ω
			28	xCell2 R_a 13	I2	0	32767	254	2 ⁻¹⁰ Ω
			30	xCell2 R_a 14	I2	0	32767	1500	2 ⁻¹⁰ Ω
Ra Table	1728	R_a3x							
			0	xCell3 R_a flag	H2	0	ffff	ffff	—
			2	xCell3 R_a 0	I2	0	32767	68	2 ⁻¹⁰ Ω
			4	xCell3 R_a 1	I2	0	32767	77	2 ⁻¹⁰ Ω
			6	xCell3 R_a 2	I2	0	32767	88	2 ⁻¹⁰ Ω
			8	xCell3 R_a 3	I2	0	32767	106	2 ⁻¹⁰ Ω
			10	xCell3 R_a 4	I2	0	32767	103	2 ⁻¹⁰ Ω
			12	xCell3 R_a 5	I2	0	32767	71	2 ⁻¹⁰ Ω
			14	xCell3 R_a 6	I2	0	32767	84	2 ⁻¹⁰ Ω
			16	xCell3 R_a 7	I2	0	32767	117	2 ⁻¹⁰ Ω
			18	xCell3 R_a 8	I2	0	32767	112	2 ⁻¹⁰ Ω
			20	xCell3 R_a 9	I2	0	32767	132	2 ⁻¹⁰ Ω
			22	xCell3 R_a 10	I2	0	32767	121	2 ⁻¹⁰ Ω
			24	xCell3 R_a 11	I2	0	32767	90	2 ⁻¹⁰ Ω
			26	xCell3 R_a 12	I2	0	32767	89	2 ⁻¹⁰ Ω
			28	xCell3 R_a 13	I2	0	32767	254	2 ⁻¹⁰ Ω
			30	xCell3 R_a 14	I2	0	32767	1500	2 ⁻¹⁰ Ω
PF Status	779	Device Status Data							
			0	Safety Alert 0–15	H2	0	ffff	0	—
			2	Safety Status 0–15	H2	0	ffff	0	—
			6	PF Alert 0–15	H2	0	ffff	0	—
			8	PF Status 0–15	H2	0	ffff	0	—
			12	Safety Alert 16–31	H2	0	ffff	0	—
			14	Safety Status 16–31	H2	0	ffff	0	—
			18	PF Alert 16–31	H2	0	ffff	0	—
			20	PF Status 16–31	H2	0	ffff	0	—
			24	Operation Status 0–15	H2	0	ffff	0	—
			26	Operation Status 16–31	H2	0	ffff	0	—
			28	Charging Status 0–15	H2	0	ffff	0	—
			30	Charging Status 16–23	H1	0	ffff	0	—

Table B-1. bq30z50-R1 Data Flash Subclass ID and Offset (Firmware v0.33) (continued)

Class	Subclass ID	Subclass	Offset	Name	Data Type	Min	Max	Default Value	Units
			31	Gauging Status	H2	0	ffff	0	—
PF Status	812	Device Voltage Data							
			0	Cell Voltage 0	I2	-32768	32768	0	mV
			2	Cell Voltage 1	I2	-32768	32768	0	mV
			4	Cell Voltage 2	I2	-32768	32768	0	mV
			6	Cell Voltage 3	I2	-32768	32768	0	mV
			8	Battery Direct Voltage	I2	-32768	32768	0	mV
			10	Pack Voltage	I2	-32768	32768	0	mV
PF Status	824	Device Current Data							
			0	Current	I2	-32768	32767	0	mA
PF Status	826	Device Temperature Data							
			0	Internal Temperature	I2	-32768	32768	0	°C
			2	External 1 Temperature	I2	-32768	32768	0	°C
			4	External 2 Temperature	I2	-32768	32768	0	°C
			6	External 3 Temperature	I2	-32768	32768	0	°C
			8	External 4 Temperature	I2	-32768	32768	0	°C
PF Status	836	Device Gauging Data							
			0	Cell0 Dod0	I2	-32768	32767	0	—
			2	Cell1 Dod0	I2	-32768	32767	0	—
			4	Cell2 Dod0	I2	-32768	32767	0	—
			6	Cell3 Dod0	I2	-32768	32767	0	—
			8	Passed Charge	I2	-32768	32768	0	mAh
PF Status	846	AFE Regs							
			0	AFE Status	H1	0	ff	0	—
			1	AFE State Control	H1	0	ff	0	—
			2	AFE Control	H1	0	ff	0	—
			3	AFE Output Status	H1	0	ff	0	—
			4	AFE Function Control	H1	0	ff	0	—
			5	AFE Cell Select	H1	0	ff	0	—
			6	AFE OCDV	H1	0	ff	0	—
			7	AFE OCDT	H1	0	ff	0	—
			8	AFE SCC	H1	0	ff	0	—
			9	AFE SCD1	H1	0	ff	0	—
			10	AFE SCD2	H1	0	ff	0	—
			11	AFE REF TRIM	H1	0	ff	0	—
Black Box	858	Safety Status							
			0	1st Status Status 0–15	H2	0	ffff	0	—
			2	1st Safety Status 16–31	H2	0	ffff	0	—
			4	1st Time to Next Event	U1	0	255	0	s

Table B-1. bq30z50-R1 Data Flash Subclass ID and Offset (Firmware v0.33) (continued)

Class	Subclass ID	Subclass	Offset	Name	Data Type	Min	Max	Default Value	Units
			5	2nd Safety Status 0–15	H2	0	ffff	0	—
			7	2nd Safety Status 16–31	H2	0	ffff	0	—
			9	2nd Time to Next Event	U1	0	255	0	s
			10	3rd Safety Status 0–15	H2	0	ffff	0	—
			12	3rd Safety Status 16–31	H2	0	ffff	0	—
			14	3rd Time to Next Event	U1	0	255	0	s
Black Box	873	PF Status							
			0	1st PF Status 0–15	H2	0	ffff	0	—
			2	1st PF Status 16–31	H2	0	ffff	0	—
			4	1st Time to Next Event	U1	0	255	0	s
			5	2nd PF Status 0–15	H2	0	ffff	0	—
			7	2nd PF Status 16–31	H2	0	ffff	0	—
			9	2nd Time to Next Event	U1	0	255	0	s
			10	3rd PF Status 0–15	H2	0	ffff	0	—
			12	3rd PF Status 16–31	H2	0	ffff	0	—
			14	3rd Time to Next Event	U1	0	255	0	s
Calibration	0	Voltage							
			0	Cell Scale 0	I2	–32767	32767	20451	—
			2	Cell Scale 1	I2	–32767	32767	20468	—
			4	Cell Scale 2	I2	–32767	32767	20520	—
			6	Cell Scale 3	I2	–32767	32767	20517	—
			8	Pack Gain	U2	0	65535	44100	—
			10	BAT Gain	U2	0	65535	44100	—
	12	Current							
			0	CC Gain	F4	1.00E–01	4.00E+00	0.9419	—
			4	Capacity Gain	F4	2.9826E+04	1.193046E+06	280932.625	—
Calibration	20	Current Offset							
			0	CC Offset	I2	–32767	32767	–7204	—
			2	Coulomb Counter Offset Samples	U2	0	65535	64	—
			4	Board Offset	I2	–32768	32767	0	—
Calibration	26	Temperature							
			0	Internal Temp Offset	I1	–128	127	0	°C
			1	External1 Temp Offset	I1	–128	127	0	°C
			2	External2 Temp Offset	I1	–128	127	0	°C
			3	External3 Temp Offset	I1	–128	127	0	°C

Table B-1. bq30z50-R1 Data Flash Subclass ID and Offset (Firmware v0.33) (continued)

Class	Subclass ID	Subclass	Offset	Name	Data Type	Min	Max	Default Value	Units
			4	External4 Temp Offset	I1	-128	127	0	°C
Calibration	31	Internal Temp Model							
			0	Int Coeff 1	I2	-32768	32767	0	—
			2	Int Coeff 2	I2	-32768	32767	0	—
			4	Int Coeff 3	I2	-32768	32767	-11136	—
			6	Int Coeff 4	I2	-32768	32767	5754	—
			8	Int Minimum AD	I2	-32768	32767	0	—
			10	Int Maximum Temp	I2	-32768	32767	5754	0.1°K
Calibration	43	Cell Temperature Model							
			0	Coeff a1	I2	-32768	32767	-14520	—
			2	Coeff a2	I2	-32768	32767	23696	—
			4	Coeff a3	I2	-32768	32767	-20298	—
			6	Coeff a4	I2	-32768	32767	28073	—
			8	Coeff a5	I2	-32768	32767	865	—
			10	Coeff b1	I2	-32768	32767	-694	—
			12	Coeff b2	I2	-32768	32767	1326	—
			14	Coeff b3	I2	-32768	32767	-3880	—
			16	Coeff b4	I2	-32768	32767	5127	—
			18	Rc0	I2	-32768	32767	11703	—
			20	Adc0	I2	-32768	32767	11703	—
			22	Rpad	I2	-32768	32767	0	—
			24	Rint	I2	-32768	32767	0	—
Calibration	69	Fet Temperature Model							
			0	Coeff a1	I2	-32768	32767	-14520	—
			2	Coeff a2	I2	-32768	32767	23696	—
			4	Coeff a3	I2	-32768	32767	-20298	—
			6	Coeff a4	I2	-32768	32767	28073	—
			8	Coeff a5	I2	-32768	32767	865	—
			10	Coeff b1	I2	-32768	32767	-694	—
			12	Coeff b2	I2	-32768	32767	1326	—
			14	Coeff b3	I2	-32768	32767	-3880	—
			16	Coeff b4	I2	-32768	32767	5127	—
			18	Rc0	I2	-32768	32767	11703	—
			20	Adc0	I2	-32768	32767	11703	—
			22	Rpad	I2	-32768	32767	0	—
			24	Rint	I2	-32768	32767	0	—
Calibration	95	Filter							
			1	Cell Voltage 1	U1	0	255	145	—
			2	Cell Voltage 2	U1	0	255	145	—
			3	Cell Voltage 3	U1	0	255	145	—
			4	Cell Voltage 4	U1	0	255	145	—
			5	Pack Voltage Out	U1	0	255	10	—
			6	Direct Battery Voltage	U1	0	255	10	—
			7	Summed Battery Voltage	U1	0	255	145	—

Table B-1. bq30z50-R1 Data Flash Subclass ID and Offset (Firmware v0.33) (continued)

Class	Subclass ID	Subclass	Offset	Name	Data Type	Min	Max	Default Value	Units
			8	Cell Temperature	U1	0	255	145	—
			9	FET Temperature	U1	0	255	145	—
Calibration	105	Current Deadband							
			0	Deadband	U1	0	255	3	mA
			1	Coulomb Counter Deadband	U1	0	255	34	290 V

Table B-2. bq30z55-R1 Data Flash Subclass ID and Offset (Firmware v0.33)

Class	Subclass ID	Subclass	Offset	Name	Data Type	Min	Max	Default Value	Units
Protections	256	CUV							
			0	Threshold	I2	0	32767	2800	mV
			2	Delay	U1	0	255	2	s
			3	Recovery	I2	0	32767	3000	mV
Protections	261	CUVC							
			0	Threshold	I2	0	32767	2900	mV
			2	Delay	U1	0	255	2	s
			3	Recovery	I2	0	32767	3000	mV
Protections	266	COV							
			0	Threshold Low Temp	I2	0	32767	4250	mV
			2	Threshold Standard Temp	I2	0	32767	4250	mV
			4	Threshold High Temp	I2	0	32767	4250	mV
			6	Threshold Rec Temp	I2	0	32767	4250	mV
			8	Delay	U1	0	255	2	s
			9	Recovery Low Temp	I2	0	32767	4150	mV
			11	Recovery Standard Temp	I2	0	32767	4150	mV
			13	Recovery High Temp	I2	0	32767	4150	mV
			15	Recovery Rec Temp	I2	0	32767	4150	mV
Protections	283	OCC1							
			0	Threshold	I2	-32768	32767	6000	mA
			2	Delay	U1	0	255	6	s
Protections	286	OCC2							
			0	Threshold	I2	-32768	32767	8000	mA
			2	Delay	U1	0	255	3	s
Protections	289	OCC							
			0	Recovery Threshold	I2	-32768	32767	-50	mA
			2	Recovery Delay	U1	0	255	5	s
Protections	292	OCD1							
			0	Threshold	I2	-32768	32767	-6000	mA
			2	Delay	U1	0	255	6	s
Protections	295	OCD2							
			0	Threshold	I2	-32768	32767	-8000	mA

Table B-2. bq30z55-R1 Data Flash Subclass ID and Offset (Firmware v0.33) (continued)

Class	Subclass ID	Subclass	Offset	Name	Data Type	Min	Max	Default Value	Units
			2	Delay	U1	0	255	3	s
Protections	298	OCD							
			0	Recovery Threshold	I2	-32768	32767	50	mA
			2	Recovery Delay	U1	0	255	5	s
Protections	301	OLD							
			0	Threshold	H1	0	0F	09	—
			1	Delay	H1	0	0F	0F	—
			2	Latch Limit	U1	0	255	0	—
			3	Counter Dec Delay	U1	0	255	10	s
			4	Recovery	U1	0	255	5	s
			5	Reset	U1	0	255	15	s
Protections	307	SCC							
			0	Threshold	H1	0	ff	77	—
			1	Latch Limit	U1	0	255	0	mA
			2	Counter Dec Delay	U1	0	255	10	s
			3	Recovery	U1	0	255	5	s
			4	Reset	U1	0	255	15	s
Protections	312	SCD1							
			0	Threshold	H1	0	ff	77	—
Protections	313	SCD2							
			0	Threshold	H1	0	ff	e7	—
Protections	314	SCD							
			0	Latch Limit	U1	0	255	0	mA
			1	Counter Dec Delay	U1	0	255	10	s
			2	Recovery	U1	0	255	5	s
			3	Reset	U1	0	255	15	s
Protections	318	OTC							
			0	Threshold	I2	-400	1500	550	1°C
			2	Delay	U1	0	255	2	s
			3	Recovery	I2	-400	1500	500	1°C
Protections	323	OTD							
			0	Threshold	I2	-400	1500	600	1°C
			2	Delay	U1	0	255	2	s
			3	Recovery	I2	-400	1500	550	1°C
Protections	328	OTF							
			0	Threshold	I2	-400	1500	800	1°C
			2	Delay	U1	0	255	2	s
			3	Recovery	I2	-400	1500	650	1°C
Protections	333	HWD							
			0	Delay	U1	0	255	10	s
Protections	334	PTO							
			0	Charge Threshold	I2	-32768	32767	2000	mA
			2	Suspend Threshold	I2	-32768	32767	1800	mA
			4	Delay	U2	0	65535	1800	s
			6	Reset	I2	0	32767	2	mAh
Protections	342	CTO							

Table B-2. bq30z55-R1 Data Flash Subclass ID and Offset (Firmware v0.33) (continued)

Class	Subclass ID	Subclass	Offset	Name	Data Type	Min	Max	Default Value	Units
			0	Charge Threshold	I2	-32768	32767	2500	mA
			2	Suspend Threshold	I2	-32768	32767	2000	mA
			4	Delay	U2	0	65535	54000	s
			6	Reset	I2	0	32767	2	mAh
Protections	350	OC							
			0	Threshold	I2	-32768	32767	300	mAh
			2	Recovery	I2	-32768	32767	2	mAh
			4	RSOC Recovery	U1	0	100	90	%
Protections	335	CHGV							
			0	Threshold	I2	-32768	32767	500	mV
			2	Delay	U1	0	255	30	s
			3	Recovery	I2	-32768	32767	-500	mV
Protections	360	CHGC							
			0	Threshold	I2	-32768	32767	500	mA
			2	Delay	U1	0	255	2	s
			3	Recovery	I2	-32768	32767	100	mA
Permanent Fail	365	CUV							
			0	Threshold	I2	0	32767	2500	mV
			2	Delay	U1	0	255	2	s
Permanent Fail	368	COV							
			0	Threshold	I2	0	32767	4400	mV
			2	Delay	U1	0	255	2	s
Permanent Fail	371	CUDEP							
			0	Threshold	I2	2500	0	32767	mV
			2	Delay	U1	2	0	255	s
Permanent Fail	374	OTCE							
			0	Threshold	I2	-400	1500	650	1°C
			2	Delay	U1	0	255	2	s
Permanent Fail	377	OTF							
			0	Threshold	I2	-400	1500	1000	1°C
			2	Delay	U1	0	255	2	s
Permanent Fail	380	QIM							
			0	Delta Threshold	I2	0	32767	500	mAh
			2	Delay	U1	0	255	2	updates
Permanent Fail	383	CB							
			0	Max Threshold	I2	0	32767	120	h
			2	Delta Threshold	U1	0	255	20	h
			3	Delay	U1	0	255	2	cycles
Permanent Fail	387	VIMR							
			0	Check Voltage	I2	0	5000	3600	mV
			2	Check Current	I2	0	32767	10	mA
			4	Delta Threshold	I2	0	5000	200	mV
			6	Delta Delay	U1	0	255	2	s
			7	Duration	U2	0	65535	100	s
Permanent Fail	396	VIMA							
			0	Check Voltage	I2	0	5000	3600	mV
			2	Check Current	I2	0	32767	10	mA
			4	Delta Threshold	I2	0	5000	300	mV
			6	Delay	U1	0	255	2	s

Table B-2. bq30z55-R1 Data Flash Subclass ID and Offset (Firmware v0.33) (continued)

Class	Subclass ID	Subclass	Offset	Name	Data Type	Min	Max	Default Value	Units
Permanent Fail	403	IMP	0	Delta Threshold	I2	0	32767	300	%
			2	Max Threshold	I2	0	32767	400	%
			4	Ra Update Counts	U1	0	255	2	counts
Permanent Fail	408	CD	0	Threshold	I2	0	32767	4200	mAh
			2	Delay	U1	0	255	2	cycles
Permanent Fail	411	CFETF	0	OFF Threshold	I2	0	500	5	mA
			2	OFF Delay	U1	0	255	2	s
Permanent Fail	414	DFET	0	OFF Threshold	I2	-500	0	-5	mA
			2	OFF Delay	U1	0	255	2	s
Permanent Fail	417	TH	4	ADC Delay	U1	0	255	10	s
			0	Threshold	I2	0	255	5	mA
Permanent Fail	422	FUSE	2	Delay	U1	0	255	2	s
			0	Threshold	I2	0	255	2	s
Permanent Fail	425	AFER	0	Threshold	U1	0	255	100	-
			1	Delay Period	U1	0	255	2	s
			2	Compare Period	U1	0	255	5	s
Permanent Fail	428	AFEC	0	Threshold	U1	0	255	100	-
			1	Delay Period	U1	0	255	5	s
Permanent Fail	430	2LVL	0	Delay	U1	0	255	2	s
			0	Threshold	I2	0	32767	5000	mV
Permanent Fail	431	OCECO	2	Delay	U1	0	255	2	s
			0	Threshold	I2	0	32767	5000	mV
Advanced Charge Algorithm	109	Temperature Ranges	0	T1 Temp	I1	-128	127	0	°C
			1	T2 Temp	I1	-128	127	12	°C
			2	T5 Temp	I1	-128	127	20	°C
			3	T6 Temp	I1	-128	127	25	°C
			4	T3 Temp	I1	-128	127	30	°C
			5	T4 Temp	I1	-128	127	55	°C
			6	Hysteresis Temp	I1	-128	127	0	°C
Advanced Charge Algorithm	116	Low Temp Charging	0	Voltage	I2	0	32767	3000	mV
			2	Current Low	I2	0	32767	132	mA
			4	Current Med	I2	0	32767	352	mA
			6	Current High	I2	0	32767	264	mA
Advanced Charge Algorithm	124	Standard Temp Charging	0	Voltage	I2	0	32767	4200	mV
			2	Current Low	I2	0	32767	1980	mA

Table B-2. bq30z55-R1 Data Flash Subclass ID and Offset (Firmware v0.33) (continued)

Class	Subclass ID	Subclass	Offset	Name	Data Type	Min	Max	Default Value	Units
			4	Current Med	I2	0	32767	4004	mA
			6	Current High	I2	0	32767	2992	mA
Advanced Charge Algorithm	132	High Temp Charging							
			0	Voltage	I2	0	32767	4000	mV
			2	Current Low	I2	0	32767	1012	%C
			4	Current Med	I2	0	32767	1980	%C
			6	Current High	I2	0	32767	1496	%C
Advanced Charge Algorithm	140	Rec Temp Charging							
			0	Voltage	I2	0	32767	4100	mV
			2	Current Low	I2	0	32767	2508	mA
			4	Current Med	I2	0	32767	4488	mA
			6	Current High	I2	0	32767	3520	mA
Advanced Charge Algorithm	148	Pre-Charging							
			0	Current	I2	0	32767	88	mA
Advanced Charge Algorithm	150	Maintenance Charging							
			0	Current	I2	0	32767	44	mA
Advanced Charge Algorithm	152	Voltage Range							
			0	Charging Voltage Low	I2	0	32767	2500	mV
			2	Charging Voltage Med	I2	0	32767	3600	mV
			4	Charging Voltage High	I2	0	32767	4000	mV
			6	Charging Voltage Hysteresis	U1	0	255	0	mV
Advanced Charge Algorithm	159	Termination Config							
			0	Charge Term Taper Current	I2	0	32767	250	mA
			4	Charge Term Voltage	I2	0	32767	75	mV
Advanced Charge Algorithm	168	Cell Balancing Config							
			0	Bal Time/mAh Cell 0	U2	0	65535	367	s/mAh
			2	Bal Time/mAh Cell 1–3	U2	0	65535	514	s/mAh
			4	Min Start Balance Delta	U1	0	255	3	mV
			5	Relax Balance Interval	U4	0	4294967295	18000	s
			9	Min Rsoc for Balancing	U1	0	100	80	%
Advanced Charge Algorithm	178	Charging Rate of Change							
			0	Current Rate	U1	1	255	1	steps
			1	Voltage Rate	U1	1	255	1	steps

Table B-2. bq30z55-R1 Data Flash Subclass ID and Offset (Firmware v0.33) (continued)

Class	Subclass ID	Subclass	Offset	Name	Data Type	Min	Max	Default Value	Units
Advanced Charge Algorithm	180	Charge Loss Compensation							
			0	CCC Current Threshold	I2	0	32767	3520	mA
			1	CCC Voltage Threshold	U1	0	255	210	mV
System Data	640	Manufacturer Data							
			0	ManufacturerInfo	S33	x	x	abcdefghijklmnop qrstuvwxyz01234 5	—
System Data	673	Integrity							
			4	Data Flash Checksum	H2	0	ffff	0	—
SBS Configuration	679	Data							
			0	Remaining AH Cap. Alarm	I2	0	32767	300	mAh
			2	Remaining WH Cap. Alarm	I2	0	32767	432	cWh
			4	Remaining Time Alarm	U2	0	65535	10	min
			6	Initial Battery Mode	H2	0	ffff	81	—
			8	Design Voltage	I2	0	32767	14400	mV
			10	Specification Information	H2	0	ffff	31	—
			12	Manufacture Date	U2	0	65535	0	date
			14	Serial Number	H2	0	ffff	1	—
			16	Cycle Count	U2	0	65535	0	—
			18	Cycle Count Percentage	U1	0	100	90	%
			19	Max Error Limit	U1	0	100	100	%
			20	Design Capacity mAh	I2	0	32767	4400	mAh
			22	Design Capacity cWh	I2	0	32767	6336	cWh
			24	Manufacturer Name	S21	x	x	Texas Instruments	—
			45	Device Name	S21	x	x	bq30z50-R1	—
			66	Device Chemistry	S5	x	x	LION	—
SBS Configuration	750	FD							
			0	Set Voltage Threshold	I2	0	5000	3000	mV
			2	Clear Voltage Threshold	I2	0	5000	3100	mV
			4	Set % RSOC Threshold	U1	0	100	0	%
			5	Clear % RSOC Threshold	U1	0	100	5	%
SBS Configuration	756	FC							
			0	Set Voltage Threshold	I2	0	5000	4200	mV
			2	Clear Voltage Threshold	I2	0	5000	4100	mV

Table B-2. bq30z55-R1 Data Flash Subclass ID and Offset (Firmware v0.33) (continued)

Class	Subclass ID	Subclass	Offset	Name	Data Type	Min	Max	Default Value	Units
			4	Set % RSOC Threshold	U1	0	100	100	%
			5	Clear % RSOC Threshold	U1	0	100	95	%
SBS Configuration	762	TDA							
			0	Set Voltage Threshold	I2	0	5000	3200	mV
			2	Clear Voltage Threshold	I2	0	5000	3300	mV
			4	Set % RSOC Threshold	U1	0	100	10	%
			5	Clear % RSOC Threshold	U1	0	100	15	%
SBS Configuration	768	TCA							
			0	Set Voltage Threshold	I2	0	5000	4200	mV
			2	Clear Voltage Threshold	I2	0	5000	4100	mV
			4	Set % RSOC Threshold	U1	0	100	100	%
			5	Clear % RSOC Threshold	U1	0	100	95	%
SBS Configuration	774	Max Error							
			3	Time Cycle Equivalent	U1	0	255	12	h
			4	Cycle Delta	U1	0	255	5	%
Lifetimes	512	Voltage							
			0	Max Cell Voltage 0	U1	0	255	0	mV
			1	Max Cell Voltage 1	U1	0	255	0	mV
			2	Max Cell Voltage 2	U1	0	255	0	mV
			3	Max Cell Voltage 3	U1	0	255	0	mV
			4	Min Cell Voltage 0	U1	0	255	255	mV
			5	Min Cell Voltage 1	U1	0	255	255	mV
			6	Min Cell Voltage 2	U1	0	255	255	mV
			7	Min Cell Voltage 3	U1	0	255	255	mV
			8	Max Delta Cell Voltage	U1	0	255	0	mV
Lifetimes	521	Current							
			0	Max Charge Current	U1	0	255	0	mA
			1	Max Discharge Current	U1	0	255	0	mA
			2	Max Avg Dsg Current	U1	0	255	0	mA
			3	Max Avg Dsg Power	U1	0	255	0	W
Lifetimes	525	Safety Events							
			0	No Of Cov Events	U1	0	255	0	events

Table B-2. bq30z55-R1 Data Flash Subclass ID and Offset (Firmware v0.33) (continued)

Class	Subclass ID	Subclass	Offset	Name	Data Type	Min	Max	Default Value	Units
			1	Last Cov Event	U1	0	255	0	cycles
			2	No Of Cuv Events	U1	0	255	0	events
			3	Last Cuv Event	U1	0	255	0	cycles
			4	No Of Ocd1 Events	U1	0	255	0	events
			5	Last Ocd1 Event	U1	0	255	0	cycles
			6	No Of Ocd2 Events	U1	0	255	0	events
			7	Last Ocd2 Event	U1	0	255	0	cycles
			8	No Of Occ1 Events	U1	0	255	0	events
			9	Last Occ1 Event	U1	0	255	0	cycles
			10	No Of Occ2 Events	U1	0	255	0	events
			11	Last Occ2 Event	U1	0	255	0	cycles
			12	No Of Old Events	U1	0	255	0	events
			13	Last Old Event	U1	0	255	0	cycles
			14	No Of Scd Events	U1	0	255	0	events
			15	Last Scd Event	U1	0	255	0	cycles
			16	No Of Scc Events	U1	0	255	0	events
			17	Last Scc Event	U1	0	255	0	cycles
			18	No Of Otc Events	U1	0	255	0	events
			19	Last Otc Event	U1	0	255	0	cycles
			20	No Of Otd Events	U1	0	255	0	events
			21	Last Otd Event	U1	0	255	0	cycles
			22	No Of Otf Events	U1	0	255	0	events
			23	Last Otf Event	U1	0	255	0	cycles
Lifetimes	549	Charging Events							
			0	No Valid Charge Term	U1	0	255	0	events
			1	Last Valid Charge Term	U1	0	255	0	cycles
Lifetimes	551	Gauging Events							
			0	No Of Qmax Updates	U1	0	255	0	events
			1	Last Qmax Update	U1	0	255	0	cycles
			2	No Of Ra Updates	U1	0	255	0	events
			3	Last Ra Update	U1	0	255	0	cycles
			4	No Of Ra Disable	U1	0	255	0	events
			5	Last Ra Disable	U1	0	255	0	cycles
Lifetimes	557	Power Events							
			0	No Of Shutdowns	U1	0	255	0	events
Lifetimes	561	Cell Balancing							
			0	Cb Time Cell 0	U1	0	255	0	h
			1	Cb Time Cell 1	U1	0	255	0	h
			2	Cb Time Cell 2	U1	0	255	0	h
			3	Cb Time Cell 3	U1	0	255	0	h

Table B-2. bq30z55-R1 Data Flash Subclass ID and Offset (Firmware v0.33) (continued)

Class	Subclass ID	Subclass	Offset	Name	Data Type	Min	Max	Default Value	Units
Lifetimes	565	Temperature							
			0	Max Temp Cell	I1	-128	127	-128	°C
			1	Min Temp Cell	I1	-128	127	127	°C
			2	Max Delta Cell Temp	I1	-128	127	0	°C
			3	Max Temp Int Sensor	I1	-128	127	-128	°C
			4	Min Temp Int Sensor	I1	-128	127	127	°C
			5	Max Temp Fet	I1	-128	127	-128	°C
Lifetimes	571	Time							
			0	Total Fw Runtime	U2	0	65535	0	h
			2	Time Spent In UT	U2	0	65535	0	h
			4	Time Spent In LT	U2	0	65535	0	h
			6	Time Spent In STL	U2	0	65535	0	h
			8	Time Spent In RT	U2	0	65535	0	h
			10	Time Spent In STH	U2	0	65535	0	h
			12	Time Spent In HT	U2	0	65535	0	h
			14	Time Spent In OT	U2	0	65535	0	h
Settings	185	Fuse							
			0	PF Fuse 0–15	H2	0	fff	0	—
			2	PF Fuse 16–31	H2	0	fff	0	—
			4	Min Blow Fuse Voltage	I2	0	65535	8000	mV
Settings	191	Manufacturing							
			0	Manufacturing Status	H2	0	fff	8000	—
Settings	193	Protection							
			0	Enabled Protections 0–15	H2	0	fff	fff	—
			2	Enabled Protections 16–31	H2	0	fff	fff	—
Settings	197	Permanent Failure							
			0	Enabled PF 0–15	H2	0	fff	fff	—
			2	Enabled PF 16–31	H2	0	fff	fff	—
Settings	201	Configuration							
			0	Protection Configuration	H1	0	ff	01	—
			1	Temperature Configuration	H2	0	fff	0087	—
			3	Charging Configuration	H1	0	ff	0	—
			4	System Configuration	H2	0	1ff	32	—
			6	Gauging Configuration	H2	0	fff	1fda	—
			8	Sbs Configuration	H1	0	ff	20	—

Table B-2. bq30z55-R1 Data Flash Subclass ID and Offset (Firmware v0.33) (continued)

Class	Subclass ID	Subclass	Offset	Name	Data Type	Min	Max	Default Value	Units
			9	Sbs Data Config. 0–15	H2	0	0fff	0Caf	—
			11	Sbs Data Config. 16–23	H1	0	ff	ff	—
Settings	213	AFE							
			1	AFE State Control	H1	0	ff	0	—
Power	228	Power							
			0	Valid Update Voltage	I2	0	32767	7500	mV
Power	230	Shutdown							
			0	Shutdown Voltage	I2	0	32767	1750	mV
			2	Shutdown Time	U1	0	255	10	s
			3	Charger Present Threshold	I2	0	32767	3000	mV
Power	235	Sleep							
			0	Sleep Current	I2	0	32767	10	mA
			7	Voltage Time	U1	0	255	5	s
			8	Current Time	U1	0	255	20	s
			9	Wake	H1	0	ff	0	—
Power	245	Ship							
			0	Delay	U1	0	255	5	s
			1	Current	I2	–250	250	10	mA
Gas Gauging	248	Current Thresholds							
			0	Dsg Current Threshold	I2	–32768	32767	100	mA
			2	Chg Current Threshold	I2	–32768	32767	50	mA
			4	Quit Current	I2	0	32767	10	mA
Gas Gauging	884	State							
			0	Qmax Cell 0	I2	0	32767	4400	mAh
			2	Qmax Cell 1	I2	0	32767	4400	mAh
			4	Qmax Cell 2	I2	0	32767	4400	mAh
			6	Qmax Cell 3	I2	0	32767	4400	mAh
			8	Qmax Pack	I2	0	32767	4400	mAh
			12	Update Status	H1	0	ff	0	—
			13	Cell 0 Chg Voltage at EoC	I2	0	32767	4200	mV
			15	Cell 1 Chg Voltage at EoC	I2	0	32767	4200	mV
			17	Cell 2 Chg Voltage at EoC	I2	0	32767	4200	mV
			19	Cell 3 Chg Voltage at EoC	I2	0	32767	4200	mV
			21	Current at EoC	I2	0	32767	250	mA
			23	Avg I Last Run	I2	–32768	32767	–2000	mA
			25	Avg P Last Run	I2	–32768	32767	–3022	cW
			27	Delta Voltage	I2	–32768	32767	0	mV
			33	Max Avg I Last Run	I2	–32768	32767	–2000	mA
			35	Max Avg P Last Run	I2	–32768	32767	–3022	cW
Gas Gauging	921	IT Cfg							
			0	Load Select	U1	0	255	7	—

Table B-2. bq30z55-R1 Data Flash Subclass ID and Offset (Firmware v0.33) (continued)

Class	Subclass ID	Subclass	Offset	Name	Data Type	Min	Max	Default Value	Units
			1	Load Mode	U1	0	255	0	—
			16	Ra Filter	U2	0	999	500	%
			19	Ra Max Delta	U1	0	255	15	%
			21	Design Resistance	I2	1	32767	42	mΩ
			23	Reference Grid	U1	0	14	4	—
			62	Term Voltage	I2	0	32767	9000	mV
			64	Term Voltage Delta	I2	0	32767	300	mV
			81	User Rate-mA	I2	-9000	0	0	mA
			83	User Rate-cW	I2	-32768	0	0	cW
			85	Reserve Cap-mAh	I2	0	9000	0	mAh
			87	Reserve Cap-cWh	I2	0	32000	0	cWh
			93	Remcap Smoothing Filter	U1	0	255	250	—
Ra Table	1280	R_a0							
			0	Cell0 R_a flag	H2	0	ffff	ff55	—
			2	Cell0 R_a 0	I2	0	32767	182	2 ⁻¹⁰ Ω
			4	Cell0 R_a 1	I2	0	32767	177	2 ⁻¹⁰ Ω
			6	Cell0 R_a 2	I2	0	32767	175	2 ⁻¹⁰ Ω
			8	Cell0 R_a 3	I2	0	32767	167	2 ⁻¹⁰ Ω
			10	Cell0 R_a 4	I2	0	32767	166	2 ⁻¹⁰ Ω
			12	Cell0 R_a 5	I2	0	32767	182	2 ⁻¹⁰ Ω
			14	Cell0 R_a 6	I2	0	32767	194	2 ⁻¹⁰ Ω
			16	Cell0 R_a 7	I2	0	32767	203	2 ⁻¹⁰ Ω
			18	Cell0 R_a 8	I2	0	32767	213	2 ⁻¹⁰ Ω
			20	Cell0 R_a 9	I2	0	32767	223	2 ⁻¹⁰ Ω
			22	Cell0 R_a 10	I2	0	32767	233	2 ⁻¹⁰ Ω
			24	Cell0 R_a 11	I2	0	32767	241	2 ⁻¹⁰ Ω
			26	Cell0 R_a 12	I2	0	32767	250	2 ⁻¹⁰ Ω
			28	Cell0 R_a 13	I2	0	32767	254	2 ⁻¹⁰ Ω
			30	Cell0 R_a 14	I2	0	32767	1500	2 ⁻¹⁰ Ω
Ra Table	1344	R_a1							
			0	Cell1 R_a flag	H2	0	ffff	ff55	—
			2	Cell1 R_a 0	I2	0	32767	163	2 ⁻¹⁰ Ω
			4	Cell1 R_a 1	I2	0	32767	151	2 ⁻¹⁰ Ω
			6	Cell1 R_a 2	I2	0	32767	152	2 ⁻¹⁰ Ω
			8	Cell1 R_a 3	I2	0	32767	143	2 ⁻¹⁰ Ω
			10	Cell1 R_a 4	I2	0	32767	145	2 ⁻¹⁰ Ω
			12	Cell1 R_a 5	I2	0	32767	162	2 ⁻¹⁰ Ω
			14	Cell1 R_a 6	I2	0	32767	178	2 ⁻¹⁰ Ω
			16	Cell1 R_a 7	I2	0	32767	188	2 ⁻¹⁰ Ω
			18	Cell1 R_a 8	I2	0	32767	200	2 ⁻¹⁰ Ω
			20	Cell1 R_a 9	I2	0	32767	206	2 ⁻¹⁰ Ω
			22	Cell1 R_a 10	I2	0	32767	216	2 ⁻¹⁰ Ω
			24	Cell1 R_a 11	I2	0	32767	230	2 ⁻¹⁰ Ω
			26	Cell1 R_a 12	I2	0	32767	240	2 ⁻¹⁰ Ω
			28	Cell1 R_a 13	I2	0	32767	254	2 ⁻¹⁰ Ω

Table B-2. bq30z55-R1 Data Flash Subclass ID and Offset (Firmware v0.33) (continued)

Class	Subclass ID	Subclass	Offset	Name	Data Type	Min	Max	Default Value	Units
			30	Cell1 R_a 14	I2	0	32767	1500	2 ⁻¹⁰ Ω
Ra Table	1408	R_a2							
			0	Cell2 R_a flag	H2	0	ffff	ff55	—
			2	Cell2 R_a 0	I2	0	32767	157	2 ⁻¹⁰ Ω
			4	Cell2 R_a 1	I2	0	32767	147	2 ⁻¹⁰ Ω
			6	Cell2 R_a 2	I2	0	32767	146	2 ⁻¹⁰ Ω
			8	Cell2 R_a 3	I2	0	32767	138	2 ⁻¹⁰ Ω
			10	Cell2 R_a 4	I2	0	32767	139	2 ⁻¹⁰ Ω
			12	Cell2 R_a 5	I2	0	32767	156	2 ⁻¹⁰ Ω
			14	Cell2 R_a 6	I2	0	32767	172	2 ⁻¹⁰ Ω
			16	Cell2 R_a 7	I2	0	32767	184	2 ⁻¹⁰ Ω
			18	Cell2 R_a 8	I2	0	32767	195	2 ⁻¹⁰ Ω
			20	Cell2 R_a 9	I2	0	32767	204	2 ⁻¹⁰ Ω
			22	Cell2 R_a 10	I2	0	32767	214	2 ⁻¹⁰ Ω
			24	Cell2 R_a 11	I2	0	32767	226	2 ⁻¹⁰ Ω
			26	Cell2 R_a 12	I2	0	32767	240	2 ⁻¹⁰ Ω
			28	Cell2 R_a 13	I2	0	32767	254	2 ⁻¹⁰ Ω
			30	Cell2 R_a 14	I2	0	32767	1500	2 ⁻¹⁰ Ω
Ra Table	1472	R_a3							
			0	Cell3 R_a flag	H2	0	ffff	ff55	—
			2	Cell3 R_a 0	I2	0	32767	68	2 ⁻¹⁰ Ω
			4	Cell3 R_a 1	I2	0	32767	77	2 ⁻¹⁰ Ω
			6	Cell3 R_a 2	I2	0	32767	88	2 ⁻¹⁰ Ω
			8	Cell3 R_a 3	I2	0	32767	106	2 ⁻¹⁰ Ω
			10	Cell3 R_a 4	I2	0	32767	103	2 ⁻¹⁰ Ω
			12	Cell3 R_a 5	I2	0	32767	71	2 ⁻¹⁰ Ω
			14	Cell3 R_a 6	I2	0	32767	84	2 ⁻¹⁰ Ω
			16	Cell3 R_a 7	I2	0	32767	117	2 ⁻¹⁰ Ω
			18	Cell3 R_a 8	I2	0	32767	112	2 ⁻¹⁰ Ω
			20	Cell3 R_a 9	I2	0	32767	132	2 ⁻¹⁰ Ω
			22	Cell3 R_a 10	I2	0	32767	121	2 ⁻¹⁰ Ω
			24	Cell3 R_a 11	I2	0	32767	90	2 ⁻¹⁰ Ω
			26	Cell3 R_a 12	I2	0	32767	89	2 ⁻¹⁰ Ω
			28	Cell3 R_a 13	I2	0	32767	254	2 ⁻¹⁰ Ω
			30	Cell3 R_a 14	I2	0	32767	1500	2 ⁻¹⁰ Ω
Ra Table	1536	R_a0x							
			0	xCell0 R_a flag	H2	0	ffff	ffff	—
			2	xCell0 R_a 0	I2	0	32767	68	2 ⁻¹⁰ Ω
			4	xCell0 R_a 1	I2	0	32767	77	2 ⁻¹⁰ Ω
			6	xCell0 R_a 2	I2	0	32767	88	2 ⁻¹⁰ Ω
			8	xCell0 R_a 3	I2	0	32767	106	2 ⁻¹⁰ Ω
			10	xCell0 R_a 4	I2	0	32767	103	2 ⁻¹⁰ Ω
			12	xCell0 R_a 5	I2	0	32767	71	2 ⁻¹⁰ Ω
			14	xCell0 R_a 6	I2	0	32767	84	2 ⁻¹⁰ Ω
			16	xCell0 R_a 7	I2	0	32767	117	2 ⁻¹⁰ Ω
			18	xCell0 R_a 8	I2	0	32767	112	2 ⁻¹⁰ Ω
			20	xCell0 R_a 9	I2	0	32767	132	2 ⁻¹⁰ Ω

Table B-2. bq30z55-R1 Data Flash Subclass ID and Offset (Firmware v0.33) (continued)

Class	Subclass ID	Subclass	Offset	Name	Data Type	Min	Max	Default Value	Units
			22	xCell0 R_a 10	I2	0	32767	121	2 ⁻¹⁰ Ω
			24	xCell0 R_a 11	I2	0	32767	90	2 ⁻¹⁰ Ω
			26	xCell0 R_a 12	I2	0	32767	89	2 ⁻¹⁰ Ω
			28	xCell0 R_a 13	I2	0	32767	254	2 ⁻¹⁰ Ω
			30	xCell0 R_a 14	I2	0	32767	1500	2 ⁻¹⁰ Ω
Ra Table	1600	R_a1x							
			0	xCell1 R_a flag	H2	0	ffff	ffff	—
			2	xCell1 R_a 0	I2	0	32767	68	2 ⁻¹⁰ Ω
			4	xCell1 R_a 1	I2	0	32767	77	2 ⁻¹⁰ Ω
			6	xCell1 R_a 2	I2	0	32767	88	2 ⁻¹⁰ Ω
			8	xCell1 R_a 3	I2	0	32767	106	2 ⁻¹⁰ Ω
			10	xCell1 R_a 4	I2	0	32767	103	2 ⁻¹⁰ Ω
			12	xCell1 R_a 5	I2	0	32767	71	2 ⁻¹⁰ Ω
			14	xCell1 R_a 6	I2	0	32767	84	2 ⁻¹⁰ Ω
			16	xCell1 R_a 7	I2	0	32767	117	2 ⁻¹⁰ Ω
			18	xCell1 R_a 8	I2	0	32767	112	2 ⁻¹⁰ Ω
			20	xCell1 R_a 9	I2	0	32767	132	2 ⁻¹⁰ Ω
			22	xCell1 R_a 10	I2	0	32767	121	2 ⁻¹⁰ Ω
			24	xCell1 R_a 11	I2	0	32767	90	2 ⁻¹⁰ Ω
			26	xCell1 R_a 12	I2	0	32767	89	2 ⁻¹⁰ Ω
			28	xCell1 R_a 13	I2	0	32767	254	2 ⁻¹⁰ Ω
			30	xCell1 R_a 14	I2	0	32767	1500	2 ⁻¹⁰ Ω
Ra Table	1664	R_a2x							
			0	xCell2 R_a flag	H2	0	ffff	ffff	—
			2	xCell2 R_a 0	I2	0	32767	68	2 ⁻¹⁰ Ω
			4	xCell2 R_a 1	I2	0	32767	77	2 ⁻¹⁰ Ω
			6	xCell2 R_a 2	I2	0	32767	88	2 ⁻¹⁰ Ω
			8	xCell2 R_a 3	I2	0	32767	106	2 ⁻¹⁰ Ω
			10	xCell2 R_a 4	I2	0	32767	103	2 ⁻¹⁰ Ω
			12	xCell2 R_a 5	I2	0	32767	71	2 ⁻¹⁰ Ω
			14	xCell2 R_a 6	I2	0	32767	84	2 ⁻¹⁰ Ω
			16	xCell2 R_a 7	I2	0	32767	117	2 ⁻¹⁰ Ω
			18	xCell2 R_a 8	I2	0	32767	112	2 ⁻¹⁰ Ω
			20	xCell2 R_a 9	I2	0	32767	132	2 ⁻¹⁰ Ω
			22	xCell2 R_a 10	I2	0	32767	121	2 ⁻¹⁰ Ω
			24	xCell2 R_a 11	I2	0	32767	90	2 ⁻¹⁰ Ω
			26	xCell2 R_a 12	I2	0	32767	89	2 ⁻¹⁰ Ω
			28	xCell2 R_a 13	I2	0	32767	254	2 ⁻¹⁰ Ω
			30	xCell2 R_a 14	I2	0	32767	1500	2 ⁻¹⁰ Ω
Ra Table	1728	R_a3x							
			0	xCell3 R_a flag	H2	0	ffff	ffff	—
			2	xCell3 R_a 0	I2	0	32767	68	2 ⁻¹⁰ Ω
			4	xCell3 R_a 1	I2	0	32767	77	2 ⁻¹⁰ Ω
			6	xCell3 R_a 2	I2	0	32767	88	2 ⁻¹⁰ Ω
			8	xCell3 R_a 3	I2	0	32767	106	2 ⁻¹⁰ Ω
			10	xCell3 R_a 4	I2	0	32767	103	2 ⁻¹⁰ Ω
			12	xCell3 R_a 5	I2	0	32767	71	2 ⁻¹⁰ Ω

Table B-2. bq30z55-R1 Data Flash Subclass ID and Offset (Firmware v0.33) (continued)

Class	Subclass ID	Subclass	Offset	Name	Data Type	Min	Max	Default Value	Units
			14	xCell3 R_a 6	I2	0	32767	84	2 ⁻¹⁰ Ω
			16	xCell3 R_a 7	I2	0	32767	117	2 ⁻¹⁰ Ω
			18	xCell3 R_a 8	I2	0	32767	112	2 ⁻¹⁰ Ω
			20	xCell3 R_a 9	I2	0	32767	132	2 ⁻¹⁰ Ω
			22	xCell3 R_a 10	I2	0	32767	121	2 ⁻¹⁰ Ω
			24	xCell3 R_a 11	I2	0	32767	90	2 ⁻¹⁰ Ω
			26	xCell3 R_a 12	I2	0	32767	89	2 ⁻¹⁰ Ω
			28	xCell3 R_a 13	I2	0	32767	254	2 ⁻¹⁰ Ω
			30	xCell3 R_a 14	I2	0	32767	1500	2 ⁻¹⁰ Ω
PF Status	779	Device Status Data							
			0	Safety Alert 0–15	H2	0	ffff	0	—
			2	Safety Status 0–15	H2	0	ffff	0	—
			6	PF Alert 0–15	H2	0	ffff	0	—
			8	PF Status 0–15	H2	0	ffff	0	—
			12	Safety Alert 16–31	H2	0	ffff	0	—
			14	Safety Status 16–31	H2	0	ffff	0	—
			18	PF Alert 16–31	H2	0	ffff	0	—
			20	PF Status 16–31	H2	0	ffff	0	—
			24	Operation Status 0–15	H2	0	ffff	0	—
			26	Operation Status 16–31	H2	0	ffff	0	—
			28	Charging Status 0–15	H2	0	ffff	0	—
			30	Charging Status 16–23	H1	0	ffff	0	—
			31	Gauging Status	H2	0	ffff	0	—
PF Status	812	Device Voltage Data							
			0	Cell Voltage 0	I2	–32768	32768	0	mV
			2	Cell Voltage 1	I2	–32768	32768	0	mV
			4	Cell Voltage 2	I2	–32768	32768	0	mV
			6	Cell Voltage 3	I2	–32768	32768	0	mV
			8	Battery Direct Voltage	I2	–32768	32768	0	mV
			10	Pack Voltage	I2	–32768	32768	0	mV
PF Status	824	Device Current Data							
			0	Current	I2	–32768	32767	0	mA
PF Status	826	Device Temperature Data							
			0	Internal Temperature	I2	–32768	32768	0	°C
			2	External 1 Temperature	I2	–32768	32768	0	°C
			4	External 2 Temperature	I2	–32768	32768	0	°C
PF Status	832	Device Gauging Data							
			0	Cell0 Dod0	I2	–32768	32767	0	—
			2	Cell1 Dod0	I2	–32768	32767	0	—

Table B-2. bq30z55-R1 Data Flash Subclass ID and Offset (Firmware v0.33) (continued)

Class	Subclass ID	Subclass	Offset	Name	Data Type	Min	Max	Default Value	Units
			4	Cell2 Dod0	I2	-32768	32767	0	—
			6	Cell3 Dod0	I2	-32768	32767	0	—
			8	Passed Charge	I2	-32768	32768	0	mAh
PF Status	842	AFE Regs							
			0	AFE Status	H1	0	ff	0	—
			1	AFE State Control	H1	0	ff	0	—
			2	AFE Control	H1	0	ff	0	—
			3	AFE Output Status	H1	0	ff	0	—
			4	AFE Function Control	H1	0	ff	0	—
			5	AFE Cell Select	H1	0	ff	0	—
			6	AFE OCDV	H1	0	ff	0	—
			7	AFE OCDT	H1	0	ff	0	—
			8	AFE SCC	H1	0	ff	0	—
			9	AFE SCD1	H1	0	ff	0	—
			10	AFE SCD2	H1	0	ff	0	—
			11	AFE REF TRIM	H1	0	ff	0	—
Black Box	854	Safety Status							
			0	1st Status Status 0–15	H2	0	ffff	0	—
			2	1st Safety Status 16–31	H2	0	ffff	0	—
			4	1st Time to Next Event	U1	0	255	0	s
			5	2nd Safety Status 0–15	H2	0	ffff	0	—
			7	2nd Safety Status 16–31	H2	0	ffff	0	—
			9	2nd Time to Next Event	U1	0	255	0	s
			10	3rd Safety Status 0–15	H2	0	ffff	0	—
			12	3rd Safety Status 16–31	H2	0	ffff	0	—
			14	3rd Time to Next Event	U1	0	255	0	s
Black Box	869	PF Status							
			0	1st PF Status 0–15	H2	0	ffff	0	—
			2	1st PF Status 16–31	H2	0	ffff	0	—
			4	1st Time to Next Event	U1	0	255	0	s
			5	2nd PF Status 0–15	H2	0	ffff	0	—
			7	2nd PF Status 16–31	H2	0	ffff	0	—
			9	2nd Time to Next Event	U1	0	255	0	s
			10	3rd PF Status 0–15	H2	0	ffff	0	—
			12	3rd PF Status 16–31	H2	0	ffff	0	—
			14	3rd Time to Next Event	U1	0	255	0	s
Calibration	0	Voltage							

Table B-2. bq30z55-R1 Data Flash Subclass ID and Offset (Firmware v0.33) (continued)

Class	Subclass ID	Subclass	Offset	Name	Data Type	Min	Max	Default Value	Units
			0	Cell Scale 0	I2	-32767	32767	20451	—
			2	Cell Scale 1	I2	-32767	32767	20468	—
			4	Cell Scale 2	I2	-32767	32767	20520	—
			6	Cell Scale 3	I2	-32767	32767	20517	—
			8	Pack Gain	U2	0	65535	44100	—
			10	BAT Gain	U2	0	65535	44100	—
Calibration	12	Current							
			0	CC Gain	F4	1.00E-01	4.00E+00	0.9419	—
			4	Capacity Gain	F4	2.9826E+04	1.193046E+06	280932.625	—
Calibration	20	Current Offset							
			0	CC Offset	I2	-32767	32767	-7204	—
			2	Coulomb Counter Offset Samples	U2	0	65535	64	—
			4	Board Offset	I2	-32768	32767	0	—
Calibration	26	Temperature							
			0	Internal Temp Offset	I1	-128	127	0	°C
			1	External1 Temp Offset	I1	-128	127	0	°C
			2	External2 Temp Offset	I1	-128	127	0	°C
Calibration	29	Internal Temp Model							
			0	Int Coeff 1	I2	-32768	32767	0	—
			2	Int Coeff 2	I2	-32768	32767	0	—
			4	Int Coeff 3	I2	-32768	32767	-11136	—
			6	Int Coeff 4	I2	-32768	32767	5754	—
			8	Int Minimum AD	I2	-32768	32767	0	—
			10	Int Maximum Temp	I2	-32768	32767	5754	0.1°K
Calibration	41	Cell Temperature Model							
			0	Coeff a1	I2	-32768	32767	-14520	—
			2	Coeff a2	I2	-32768	32767	23696	—
			4	Coeff a3	I2	-32768	32767	-20298	—
			6	Coeff a4	I2	-32768	32767	28073	—
			8	Coeff a5	I2	-32768	32767	865	—
			10	Coeff b1	I2	-32768	32767	-694	—
			12	Coeff b2	I2	-32768	32767	1326	—
			14	Coeff b3	I2	-32768	32767	-3880	—
			16	Coeff b4	I2	-32768	32767	5127	—
			18	Rc0	I2	-32768	32767	11703	—
			20	Adc0	I2	-32768	32767	11703	—
			22	Rpad	I2	-32768	32767	0	—
			24	Rint	I2	-32768	32767	0	—
Calibration	67	Fet Temperature Model							
			0	Coeff a1	I2	-32768	32767	-14520	—
			2	Coeff a2	I2	-32768	32767	23696	—
			4	Coeff a3	I2	-32768	32767	-20298	—
			6	Coeff a4	I2	-32768	32767	28073	—

Table B-2. bq30z55-R1 Data Flash Subclass ID and Offset (Firmware v0.33) (continued)

Class	Subclass ID	Subclass	Offset	Name	Data Type	Min	Max	Default Value	Units
			8	Coeff a5	I2	-32768	32767	865	—
			10	Coeff b1	I2	-32768	32767	-694	—
			12	Coeff b2	I2	-32768	32767	1326	—
			14	Coeff b3	I2	-32768	32767	-3880	—
			16	Coeff b4	I2	-32768	32767	5127	—
			18	Rc0	I2	-32768	32767	11703	—
			20	Adc0	I2	-32768	32767	11703	—
			22	Rpad	I2	-32768	32767	0	—
			24	Rint	I2	-32768	32767	0	—
Calibration	93	Filter							
			1	Cell Voltage 1	U1	0	255	145	—
			2	Cell Voltage 2	U1	0	255	145	—
			3	Cell Voltage 3	U1	0	255	145	—
			4	Cell Voltage 4	U1	0	255	145	—
			5	Pack Voltage Out	U1	0	255	10	—
			6	Direct Battery Voltage	U1	0	255	10	—
			7	Summed Battery Voltage	U1	0	255	145	—
			8	Cell Temperature	U1	0	255	145	—
			9	FET Temperature	U1	0	255	145	—
Calibration	103	Current Deadband							
			0	Deadband	U1	0	255	3	mA
			1	Coulomb Counter Deadband	U1	0	255	34	290 V

Sample Filter Settings

Table C-1. Sample Remcap Filter Settings and Associated Low-Pass Filter Time Constants

Remcap Smoothing Filter	Effective Low-Pass Time Constant
200	11 seconds
230	22 seconds
240	36 seconds
245	54 seconds
250	100 seconds
252	146 seconds
253	3.2 minutes
254	4.8 minutes
255 (max)	9.6 minutes

Table C-2. Sample V/I/T Filter Settings and Associated Low-Pass Filter Time Constants

V/I/T Smoothing Filter	Effective Low-Pass Time Constant
10	0.25 seconds
50	0.5 seconds
145	1 second
200	3 seconds

Revision History

Changes from Original (January 2012) to A Revision	Page
• Changed Notational Conventions throughout the document	9
• Changed Section 4.4	33

NOTE: Page numbers for previous revisions may differ from page numbers in the current version.

IMPORTANT NOTICE

Texas Instruments Incorporated and its subsidiaries (TI) reserve the right to make corrections, enhancements, improvements and other changes to its semiconductor products and services per JESD46, latest issue, and to discontinue any product or service per JESD48, latest issue. Buyers should obtain the latest relevant information before placing orders and should verify that such information is current and complete. All semiconductor products (also referred to herein as "components") are sold subject to TI's terms and conditions of sale supplied at the time of order acknowledgment.

TI warrants performance of its components to the specifications applicable at the time of sale, in accordance with the warranty in TI's terms and conditions of sale of semiconductor products. Testing and other quality control techniques are used to the extent TI deems necessary to support this warranty. Except where mandated by applicable law, testing of all parameters of each component is not necessarily performed.

TI assumes no liability for applications assistance or the design of Buyers' products. Buyers are responsible for their products and applications using TI components. To minimize the risks associated with Buyers' products and applications, Buyers should provide adequate design and operating safeguards.

TI does not warrant or represent that any license, either express or implied, is granted under any patent right, copyright, mask work right, or other intellectual property right relating to any combination, machine, or process in which TI components or services are used. Information published by TI regarding third-party products or services does not constitute a license to use such products or services or a warranty or endorsement thereof. Use of such information may require a license from a third party under the patents or other intellectual property of the third party, or a license from TI under the patents or other intellectual property of TI.

Reproduction of significant portions of TI information in TI data books or data sheets is permissible only if reproduction is without alteration and is accompanied by all associated warranties, conditions, limitations, and notices. TI is not responsible or liable for such altered documentation. Information of third parties may be subject to additional restrictions.

Resale of TI components or services with statements different from or beyond the parameters stated by TI for that component or service voids all express and any implied warranties for the associated TI component or service and is an unfair and deceptive business practice. TI is not responsible or liable for any such statements.

Buyer acknowledges and agrees that it is solely responsible for compliance with all legal, regulatory and safety-related requirements concerning its products, and any use of TI components in its applications, notwithstanding any applications-related information or support that may be provided by TI. Buyer represents and agrees that it has all the necessary expertise to create and implement safeguards which anticipate dangerous consequences of failures, monitor failures and their consequences, lessen the likelihood of failures that might cause harm and take appropriate remedial actions. Buyer will fully indemnify TI and its representatives against any damages arising out of the use of any TI components in safety-critical applications.

In some cases, TI components may be promoted specifically to facilitate safety-related applications. With such components, TI's goal is to help enable customers to design and create their own end-product solutions that meet applicable functional safety standards and requirements. Nonetheless, such components are subject to these terms.

No TI components are authorized for use in FDA Class III (or similar life-critical medical equipment) unless authorized officers of the parties have executed a special agreement specifically governing such use.

Only those TI components which TI has specifically designated as military grade or "enhanced plastic" are designed and intended for use in military/aerospace applications or environments. Buyer acknowledges and agrees that any military or aerospace use of TI components which have **not** been so designated is solely at the Buyer's risk, and that Buyer is solely responsible for compliance with all legal and regulatory requirements in connection with such use.

TI has specifically designated certain components as meeting ISO/TS16949 requirements, mainly for automotive use. In any case of use of non-designated products, TI will not be responsible for any failure to meet ISO/TS16949.

Products

Audio	www.ti.com/audio
Amplifiers	amplifier.ti.com
Data Converters	dataconverter.ti.com
DLP® Products	www.dlp.com
DSP	dsp.ti.com
Clocks and Timers	www.ti.com/clocks
Interface	interface.ti.com
Logic	logic.ti.com
Power Mgmt	power.ti.com
Microcontrollers	microcontroller.ti.com
RFID	www.ti-rfid.com
OMAP Applications Processors	www.ti.com/omap
Wireless Connectivity	www.ti.com/wirelessconnectivity

Applications

Automotive and Transportation	www.ti.com/automotive
Communications and Telecom	www.ti.com/communications
Computers and Peripherals	www.ti.com/computers
Consumer Electronics	www.ti.com/consumer-apps
Energy and Lighting	www.ti.com/energy
Industrial	www.ti.com/industrial
Medical	www.ti.com/medical
Security	www.ti.com/security
Space, Avionics and Defense	www.ti.com/space-avionics-defense
Video and Imaging	www.ti.com/video

TI E2E Community

e2e.ti.com