

C2M1000170D

Silicon Carbide Power MOSFET
C2M™ MOSFET Technology
 N-Channel Enhancement Mode

V_{DS}	1700 V
$I_D @ 25^\circ\text{C}$	5.0 A
$R_{DS(on)}$	1.0 Ω

Features

- High Speed Switching with Low Capacitances
- High Blocking Voltage with Low $R_{DS(on)}$
- Easy to Parallel and Simple to Drive
- Ultra-low Drain-gate capacitance
- Halogen Free, RoHS Compliant

Benefits

- Higher System Efficiency
- Increased System Switching Frequency
- Reduced Cooling Requirements
- Increased System Reliability

Applications

- Auxiliary Power Supplies
- Switch Mode Power Supplies
- High-voltage Capacitive Loads

Package



TO-247-3

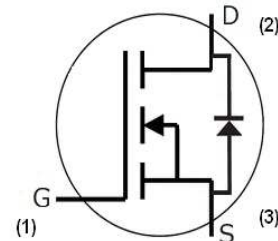

Ordering Part Number	Package	Marking
C2M1000170D	TO-247-3	C2M1000170

Maximum Ratings ($T_c = 25^\circ\text{C}$ unless otherwise specified)

Symbol	Parameter	Value	Unit	Test Conditions	Note
V_{DSmax}	Drain - Source Voltage	1700	V	$V_{GS} = 0\text{ V}, I_D = 100\ \mu\text{A}$	
V_{GSmax}	Gate - Source Voltage	-10/+25	V	Absolute maximum values	
V_{GSop}	Gate - Source Voltage	-5/+20	V	Recommended operational values	
I_D	Continuous Drain Current	5.0	A	$V_{GS} = 20\text{ V}, T_C = 25^\circ\text{C}$	Fig. 19
		3.5		$V_{GS} = 20\text{ V}, T_C = 100^\circ\text{C}$	
$I_{D(pulse)}$	Pulsed Drain Current	15	A	Pulse width t_p limited by T_{jmax}	Fig. 22
P_D	Power Dissipation	69	W	$T_c = 25^\circ\text{C}, T_j = 150^\circ\text{C}$	Fig. 20
T_j, T_{stg}	Operating Junction and Storage Temperature	-55 to +150	$^\circ\text{C}$		
T_L	Solder Temperature	260	$^\circ\text{C}$	1.6mm (0.063") from case for 10s	
M_d	Mounting Torque	1	Nm	M3 or 6-32 screw	
		8.8			

Electrical Characteristics ($T_c = 25^\circ\text{C}$ unless otherwise specified)

Symbol	Parameter	Min.	Typ.	Max.	Unit	Test Conditions	Note
$V_{(BR)DSS}$	Drain-Source Breakdown Voltage	1700			V	$V_{GS} = 0\text{ V}, I_D = 100\ \mu\text{A}$	
$V_{GS(th)}$	Gate Threshold Voltage	2.0	2.8	4	V	$V_{DS} = V_{GS}, I_D = 0.5\ \text{mA}$	Fig. 11
			2.4		V	$V_{DS} = V_{GS}, I_D = 0.5\ \text{mA}, T_J = 150^\circ\text{C}$	
I_{DSS}	Zero Gate Voltage Drain Current		1	100	μA	$V_{DS} = 1.7\ \text{kV}, V_{GS} = 0\ \text{V}$	
I_{GSS}	Gate-Source Leakage Current			250	nA	$V_{GS} = 20\ \text{V}, V_{DS} = 0\ \text{V}$	
$R_{DS(on)}$	Drain-Source On-State Resistance		0.80	1.4	Ω	$V_{GS} = 20\ \text{V}, I_D = 2\ \text{A}$	Fig. 4,5,6
			1.4			$V_{GS} = 20\ \text{V}, I_D = 2\ \text{A}, T_J = 150^\circ\text{C}$	
g_{fs}	Transconductance		1.04		S	$V_{DS} = 20\ \text{V}, I_{DS} = 2\ \text{A}$	Fig. 7
			1.09			$V_{DS} = 20\ \text{V}, I_{DS} = 2\ \text{A}, T_J = 150^\circ\text{C}$	
C_{iss}	Input Capacitance		215		pF	$V_{GS} = 0\ \text{V}$ $V_{DS} = 1000\ \text{V}$ $f = 1\ \text{MHz}$	Fig. 17,18
C_{oss}	Output Capacitance		19				
C_{riss}	Reverse Transfer Capacitance		2.2				
E_{oss}	C_{oss} Stored Energy		10.2		μJ	$V_{AC} = 25\ \text{mV}$	Fig. 16
E_{ON}	Turn-On Switching Energy		89		μJ	$V_{DS} = 1.2\ \text{kV}, V_{GS} = -5/20\ \text{V}$ $I_D = 2\ \text{A}, R_{G(ext)} = 2.5\ \Omega,$ $L = 1478\ \mu\text{H}, T_J = 150^\circ\text{C}$	Fig. 26
E_{OFF}	Turn Off Switching Energy		14				
$t_{d(on)}$	Turn-On Delay Time		5		ns	$V_{DD} = 1.2\ \text{kV}, V_{GS} = -5/20\ \text{V}$ $I_D = 2\ \text{A}, R_{G(ext)} = 2.5\ \Omega, R_L = 600\ \Omega$ Timing relative to V_{DS} Per IEC60747-8-4 pg 83	Fig. 27
t_r	Rise Time		19				
$t_{d(off)}$	Turn-Off Delay Time		14				
t_f	Fall Time		63				
$R_{G(int)}$	Internal Gate Resistance		24.8		Ω	$f = 1\ \text{MHz}, V_{AC} = 25\ \text{mV}$	
Q_{gs}	Gate to Source Charge		4		nC	$V_{DS} = 1.2\ \text{kV}, V_{GS} = -5/20\ \text{V}$ $I_D = 2\ \text{A}$ Per IEC60747-8-4 pg 21	Fig. 12
Q_{gd}	Gate to Drain Charge		12				
Q_g	Total Gate Charge		22				

Reverse Diode Characteristics

Symbol	Parameter	Typ.	Max.	Unit	Test Conditions	Note
V_{SD}	Diode Forward Voltage	3.8		V	$V_{GS} = -5\ \text{V}, I_{SD} = 1\ \text{A}, T_J = 25^\circ\text{C}$	Fig. 8, 9, 10
		3.3		V	$V_{GS} = -5\ \text{V}, I_{SD} = 1\ \text{A}, T_J = 150^\circ\text{C}$	
I_S	Continuous Diode Forward Current		4	A	$T_c = 25^\circ\text{C}$	Note 1
t_{rr}	Reverse Recovery Time	30		ns	$V_{GS} = -5\ \text{V}, I_{SD} = 2\ \text{A}, T_J = 150^\circ\text{C}$ $V_R = 1.2\ \text{kV}$ $\text{dif}/\text{dt} = 1135\ \text{A}/\mu\text{s}$	Note 1
Q_{rr}	Reverse Recovery Charge	31		nC		
I_{rrm}	Peak Reverse Recovery Current	3		A		

Note (1): When using SiC Body Diode the maximum recommended $V_{GS} = -5\text{V}$

Thermal Characteristics

Symbol	Parameter	Typ.	Max.	Unit	Test Conditions	Note
$R_{\theta JC}$	Thermal Resistance from Junction to Case	1.7	1.8	$^\circ\text{C}/\text{W}$		Fig. 21
$R_{\theta JA}$	Thermal Resistance from Junction to Ambient		40			

Typical Performance

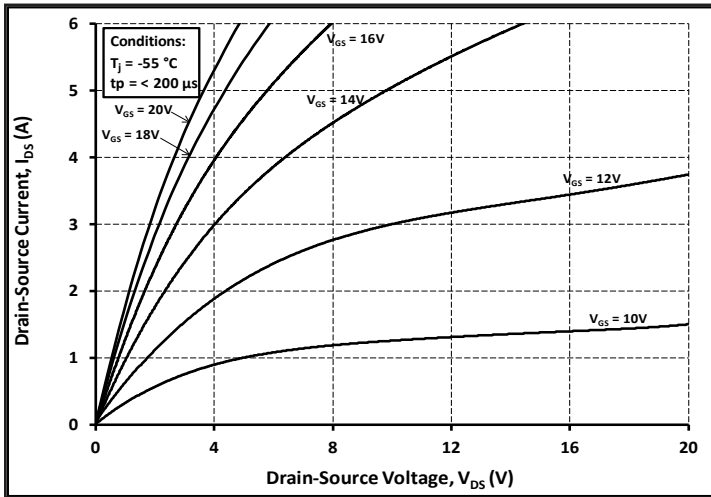

Figure 1. Output Characteristics $T_J = -55\text{ }^\circ\text{C}$

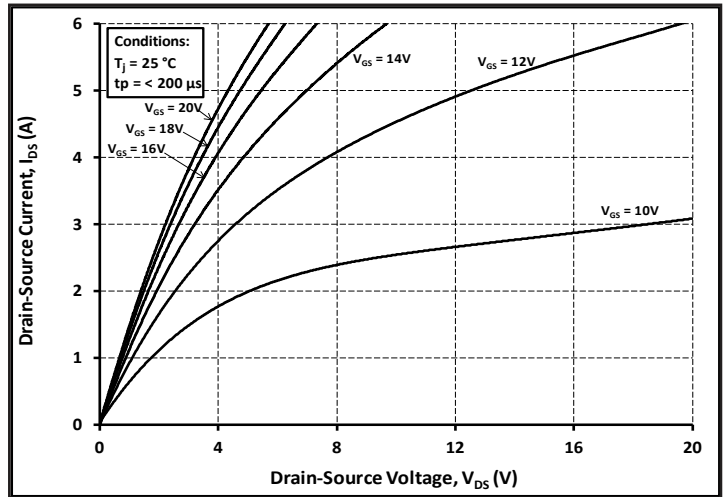

Figure 2. Output Characteristics $T_J = 25\text{ }^\circ\text{C}$

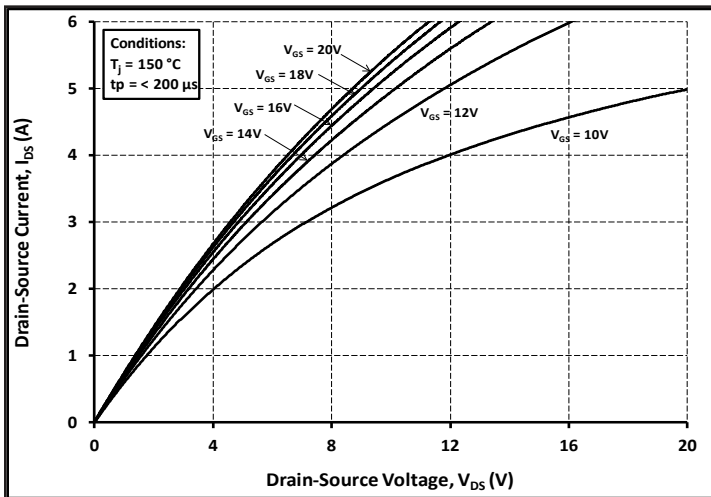

Figure 3. Output Characteristics $T_J = 150\text{ }^\circ\text{C}$

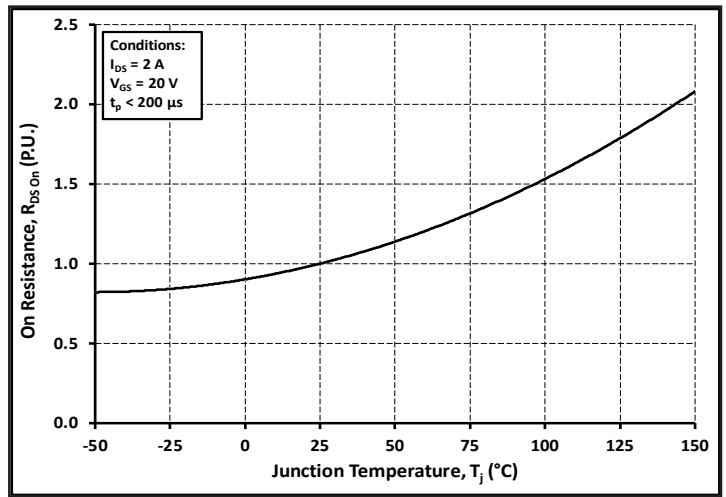

Figure 4. Normalized On-Resistance vs. Temperature

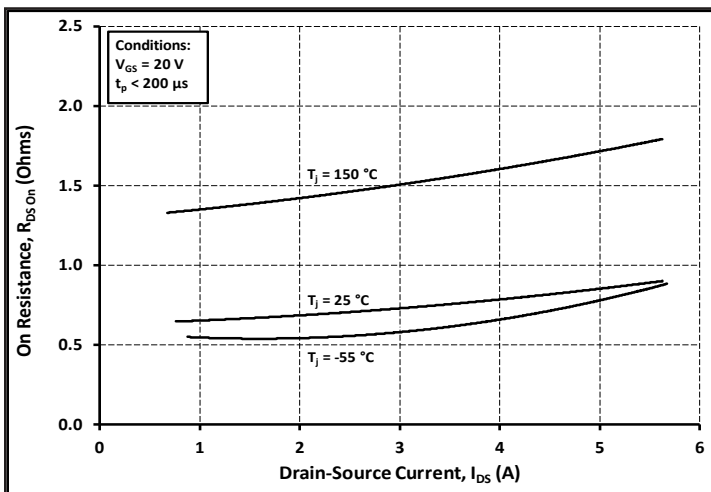

Figure 5. On-Resistance vs. Drain Current For Various Temperatures

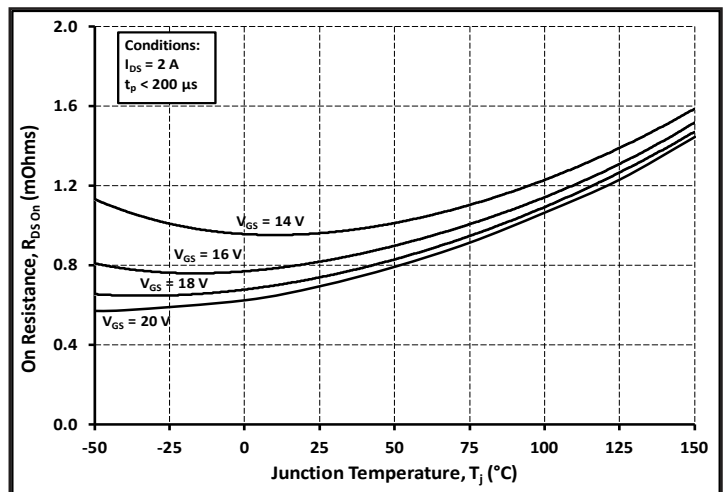

Figure 6. On-Resistance vs. Temperature For Various Gate Voltage

Typical Performance

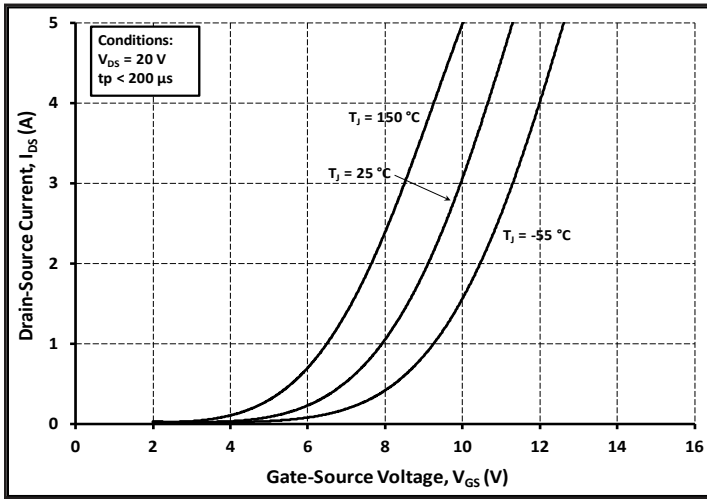

Figure 7. Transfer Characteristic for Various Junction Temperatures

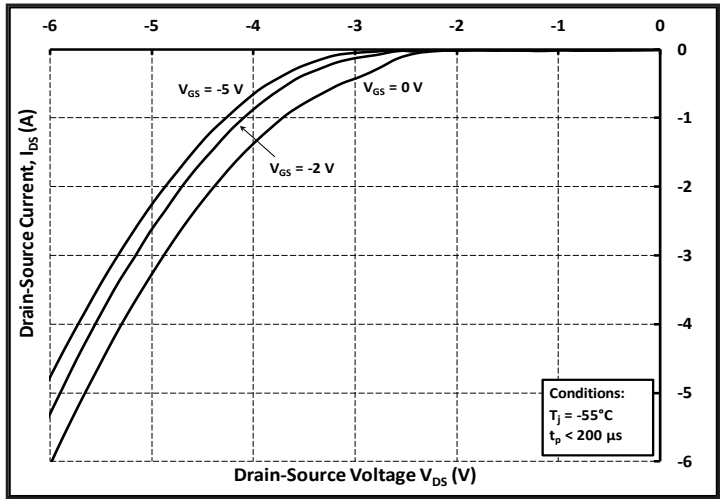

Figure 8. Body Diode Characteristic at $-55\text{ }^\circ\text{C}$

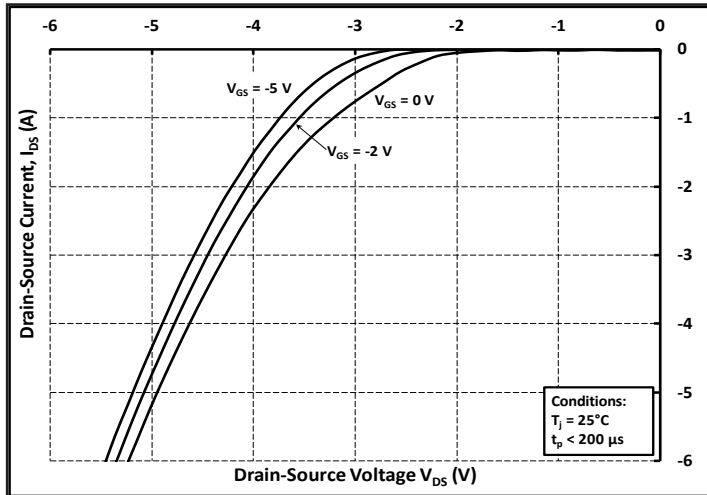

Figure 9. Body Diode Characteristic at $25\text{ }^\circ\text{C}$

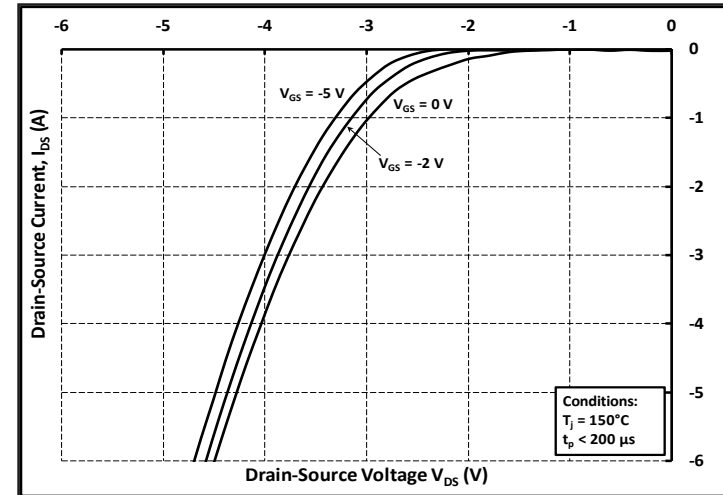

Figure 10. Body Diode Characteristic at $150\text{ }^\circ\text{C}$

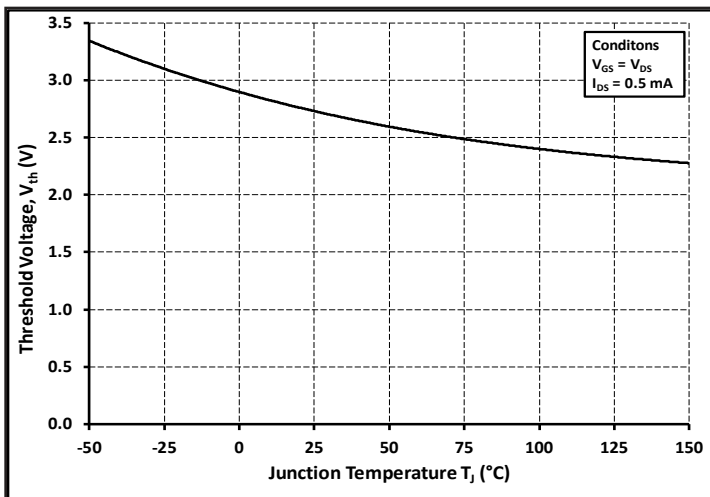

Figure 11. Threshold Voltage vs. Temperature

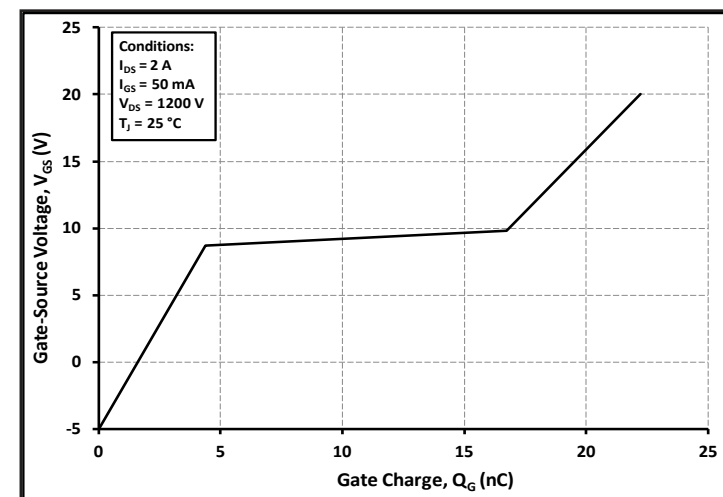

Figure 12. Gate Charge Characteristics

Typical Performance

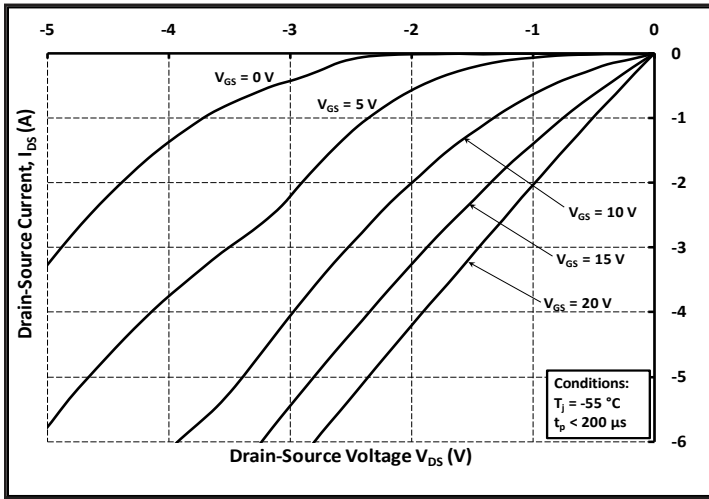

Figure 13. 3rd Quadrant Characteristic at $-55\text{ }^\circ\text{C}$

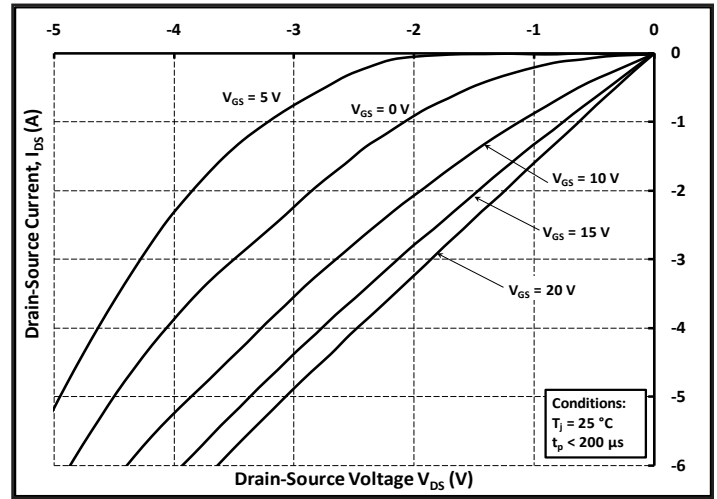

Figure 14. 3rd Quadrant Characteristic at $25\text{ }^\circ\text{C}$

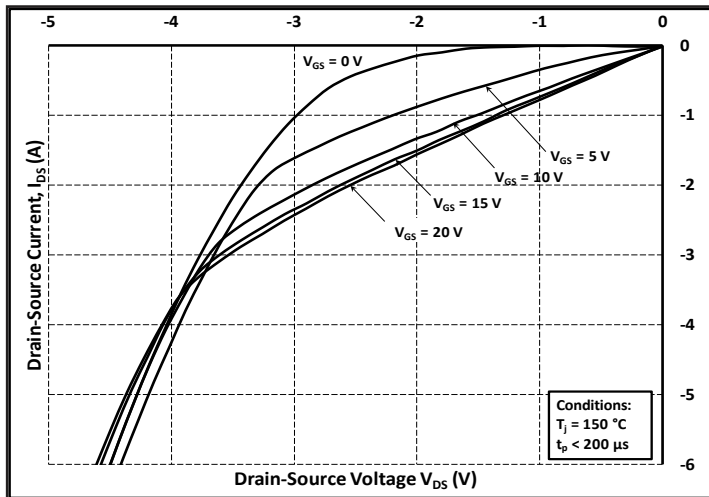

Figure 15. 3rd Quadrant Characteristic at $150\text{ }^\circ\text{C}$

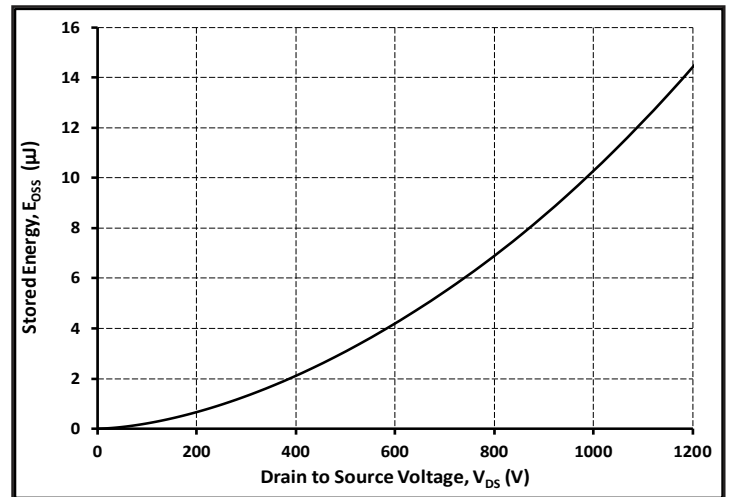

Figure 16. Output Capacitor Stored Energy

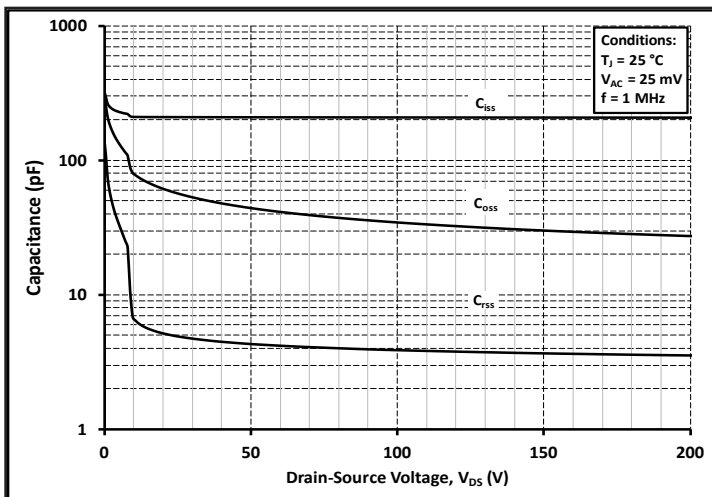

Figure 17. Capacitances vs. Drain-Source Voltage (0-200 V)

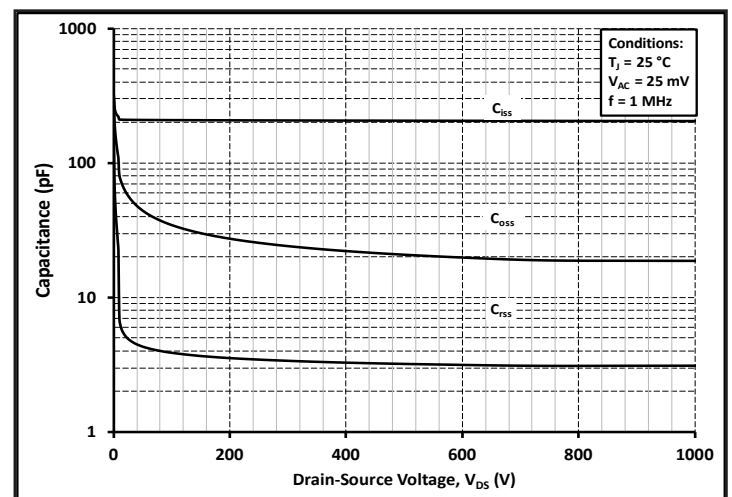

Figure 18. Capacitances vs. Drain-Source Voltage (0-1000 V)

Typical Performance

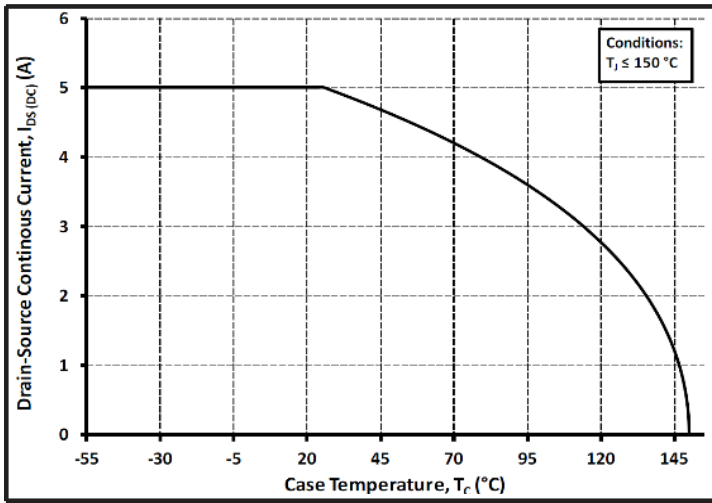

Figure 19. Continuous Drain Current Derating vs. Case Temperature

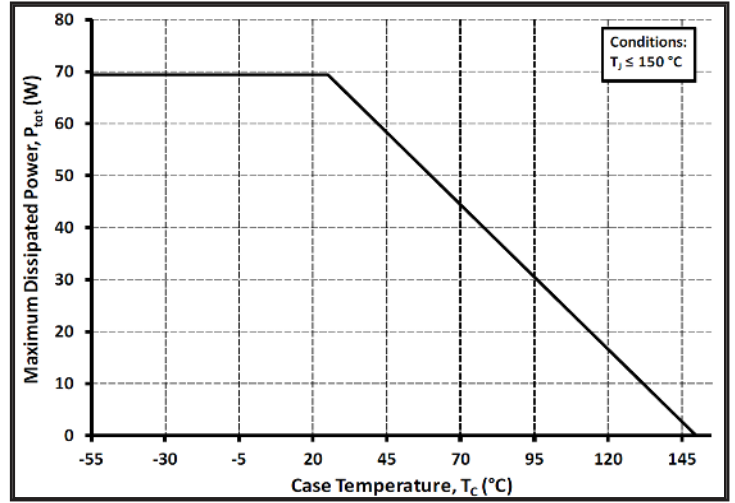

Figure 20. Maximum Power Dissipation Derating vs. Case Temperature

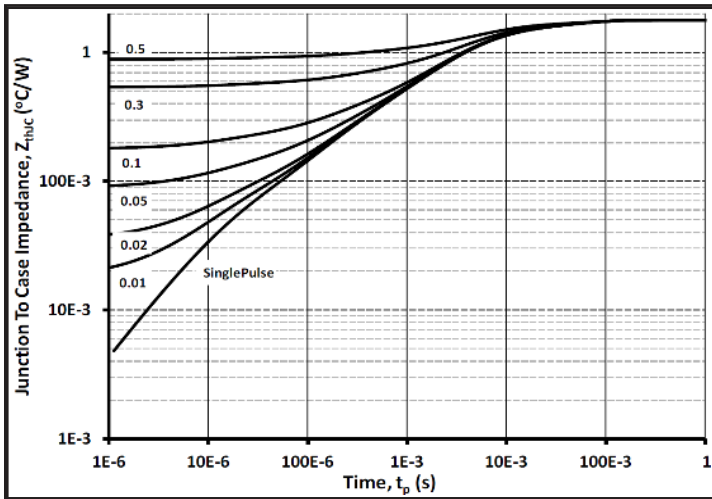

Figure 21. Transient Thermal Impedance (Junction - Case)

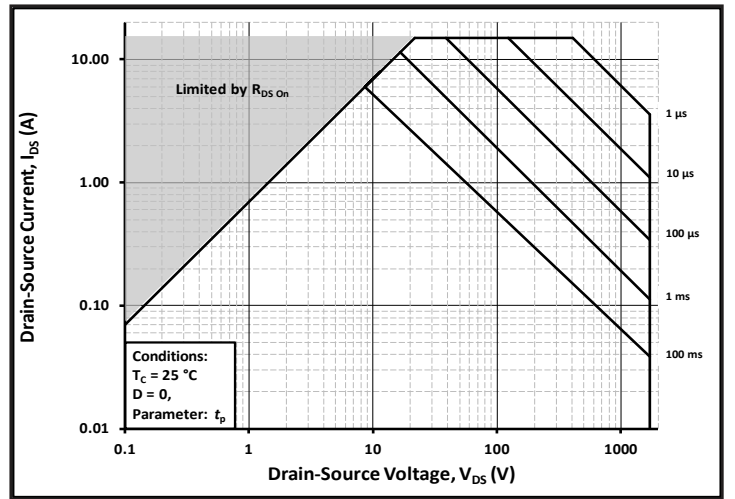

Figure 22. Safe Operating Area

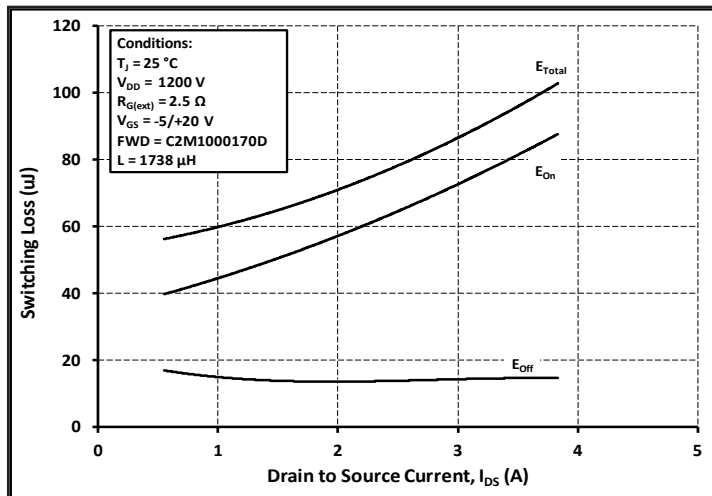

Figure 23. Clamped Inductive Switching Energy vs. Drain Current ($V_{DD} = 1200V$)

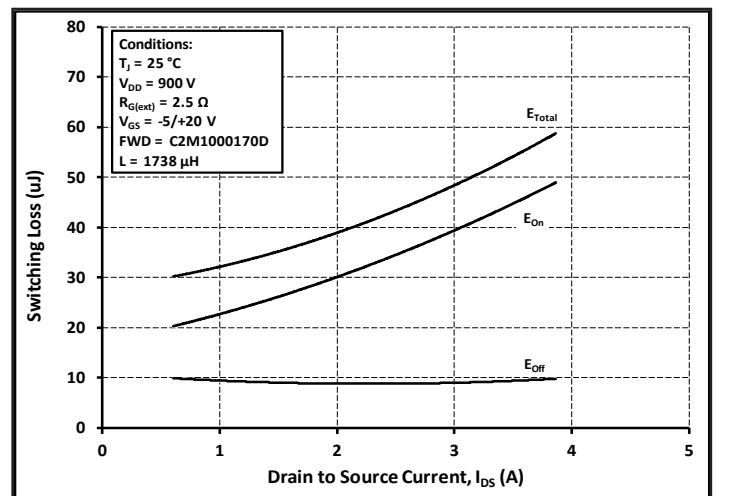

Figure 24. Clamped Inductive Switching Energy vs. Drain Current ($V_{DD} = 900V$)

Typical Performance

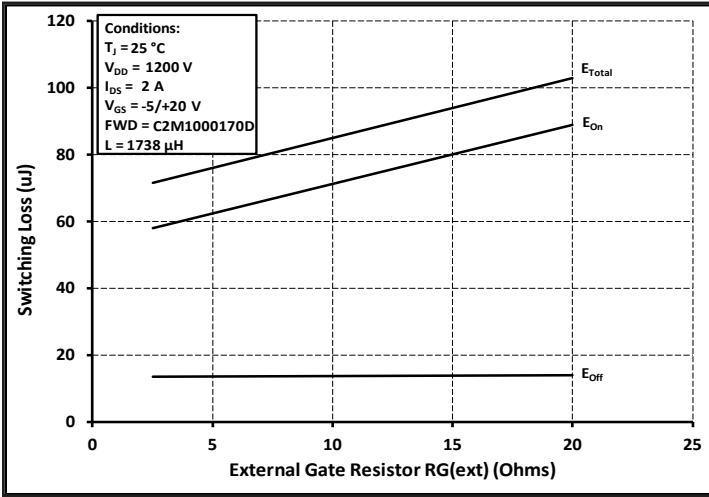

Figure 25. Clamped Inductive Switching Energy vs. $R_{G(ext)}$

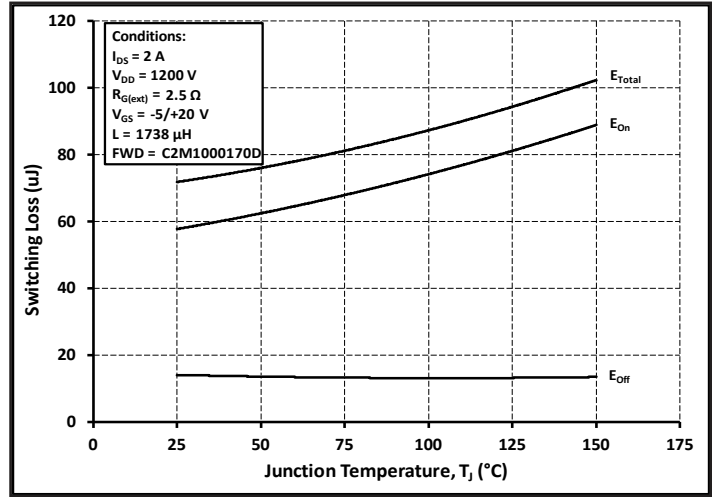

Figure 26. Clamped Inductive Switching Energy vs. Temperature

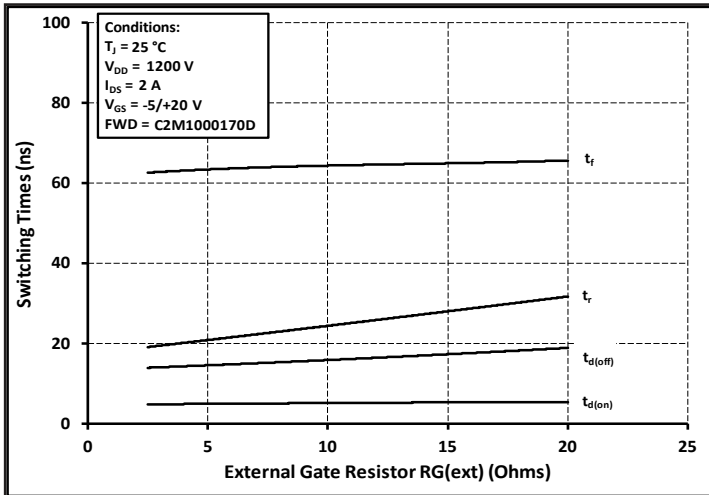

Figure 27. Switching Times vs. $R_{G(ext)}$

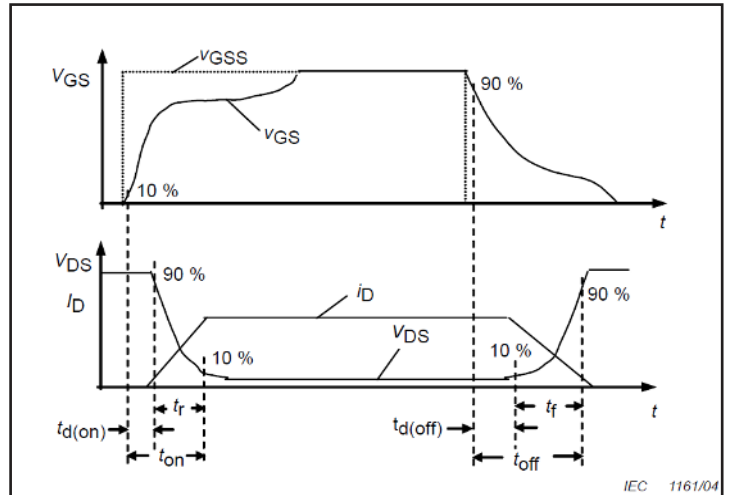

Figure 28. Switching Times Definition

Test Circuit Schematic

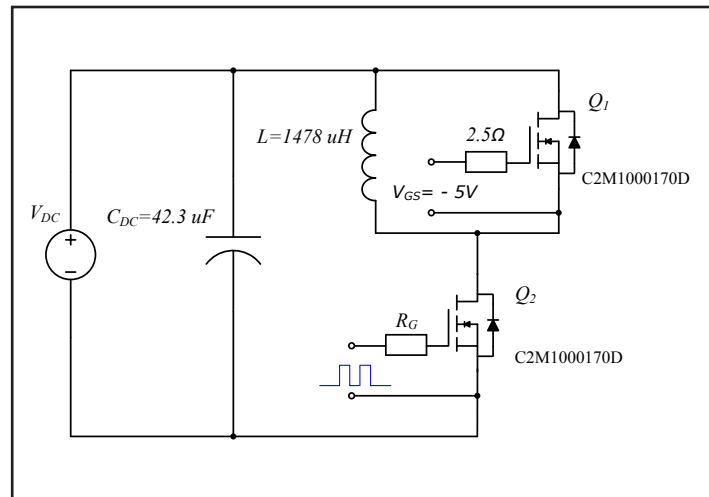

Figure 29. Clamped Inductive Switching Waveform Test Circuit

ESD Ratings

ESD Test	Total Devices Sampled	Resulting Classification
ESD-HBM	All Devices Passed 4000V	3A (>4000V)
ESD-CDM	All Devices Passed 1000V	IV (>1000V)

Package Dimensions

Package TO-247-3

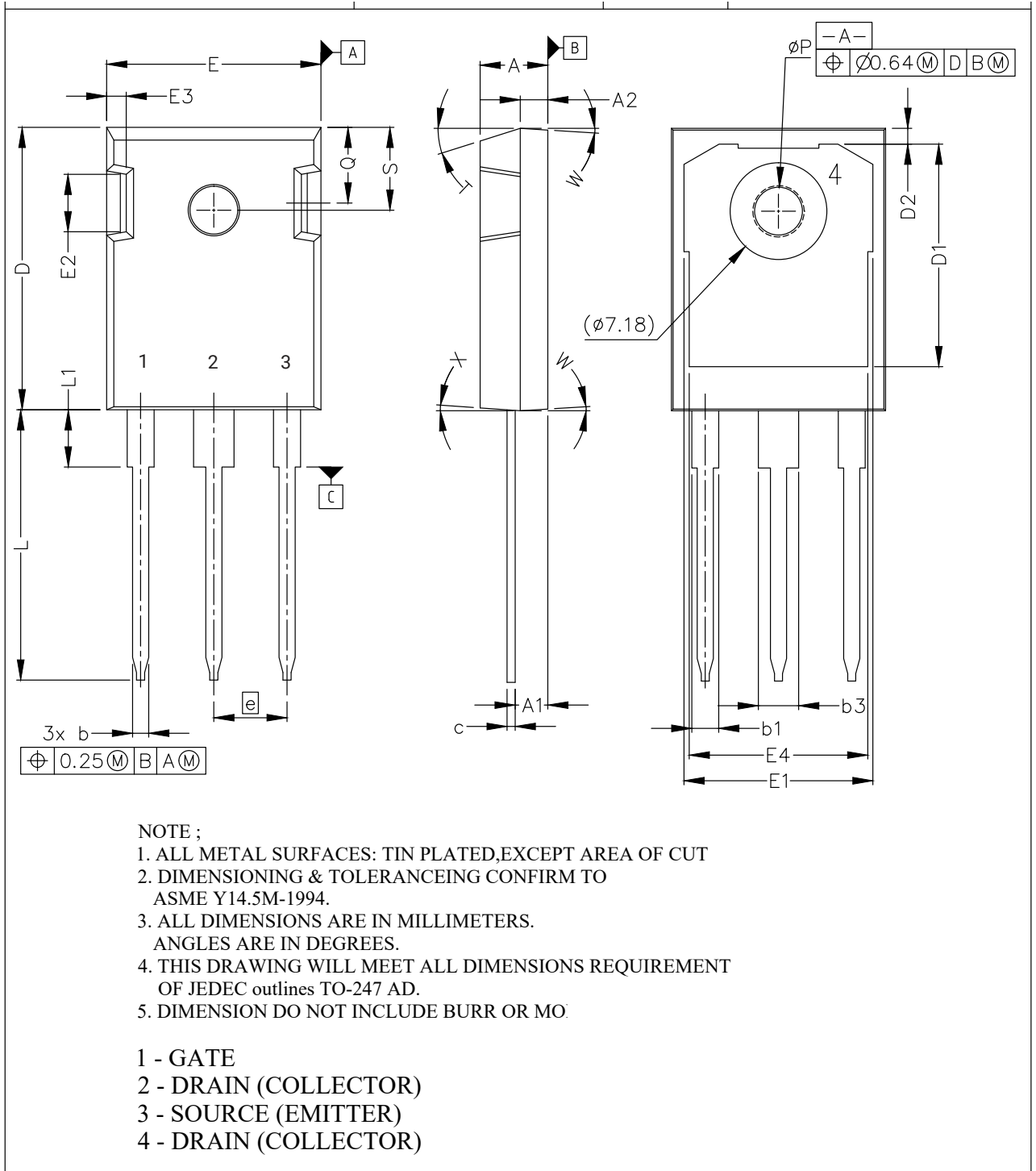

Package Dimensions

Package TO-247-3

SYM	MILLIMETERS		INCHES	
	MIN	MAX	MIN	MAX
A	4.83	5.21	.190	.205
A1	2.29	2.54	.090	.100
A2	1.91	2.16	.075	.085
b	1.07	1.33	.042	.052
b1	1.91	2.41	.075	.095
b3	2.87	3.38	.113	.133
c	0.55	0.68	.022	.027
D	20.80	21.10	.819	.831
D1	16.25	17.65	.640	.695
D2	0.95	1.25	.037	.049
E	15.75	16.13	.620	.635
E1	13.10	14.15	.516	.557
E2	3.68	5.10	.145	.201
E3	1.00	1.90	.039	.075
E4	12.38	13.43	.487	.529
e	5.44 BSC		.214 BSC	
N	3		3	
L	19.81	20.32	.780	.800
L1	4.10	4.40	.161	.173
ØP	3.51	3.65	.138	.144
Q	5.49	6.00	.216	.236
S	6.04	6.30	.238	.248
T	17.5° REF.			
W	3.5° REF.			
X	4° REF.			

Recommended Solder Pad Layout

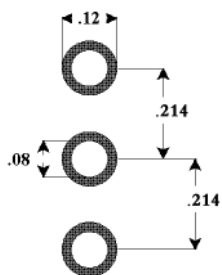

TO-247-3

Notes

- **RoHS Compliance**
The levels of RoHS restricted materials in this product are below the maximum concentration values (also referred to as the threshold limits) permitted for such substances, or are used in an exempted application, in accordance with EU Directive 2011/65/EC (RoHS2), as implemented January 2, 2013. RoHS Declarations for this product can be obtained from your Cree representative or from the Product Documentation sections of www.cree.com.
- **REACH Compliance**
REACH substances of high concern (SVHCs) information is available for this product. Since the European Chemical Agency (ECHA) has published notice of their intent to frequently revise the SVHC listing for the foreseeable future, please contact a Cree representative to insure you get the most up-to-date REACH SVHC Declaration. REACH banned substance information (REACH Article 67) is also available upon request.
- This product has not been designed or tested for use in, and is not intended for use in, applications implanted into the human body nor in applications in which failure of the product could lead to death, personal injury or property damage, including but not limited to equipment used in the operation of nuclear facilities, life-support machines, cardiac defibrillators or similar emergency medical equipment, aircraft navigation or communication or control systems, air traffic control systems.

Related Links

- **C2M PSPICE Models:** <http://wolfspeed.com/power/tools-and-support>
- **SiC MOSFET Isolated Gate Driver reference design:** <http://wolfspeed.com/power/tools-and-support>
- **SiC MOSFET Evaluation Board:** <http://wolfspeed.com/power/tools-and-support>
- **60W Auxiliary power supply reference design:** <http://wolfspeed.com/power/tools-and-support>