



Features

- Input Voltage: 5V
- 84% Efficiency
- Industrial Temperature Range: -40°C to +85°C
- Under-Voltage Lockout
- Soft Start
- Small Footprint: 0.94in × 0.35in (Vertical package)
- Solderable Copper Case
- Surface Mountable
- IPC Lead Free 2

Description

The PT5540 Excalibur™ power modules are a series of integrated switching regulators (ISRs) that provide a boost-voltage function. They are designed for use with +5V bus systems that require an additional higher voltage rail.

The modules are rated 12W and produce a fixed output voltage over the full industrial temperature range of -40°C to +85°C. The series includes the common output voltages, +12V and +15V. Applications include PCI cards, audio circuits, and battery operated instruments.

The PT5540 series is packaged in a 3-pin thermally efficient copper case. The case is solderable, has a small footprint, and can accommodate both through-hole and surface mount pin configurations.

The PT5540 series is offered as a next generation replacement to the popular PT5040 series. The PT5540 has a lower operating temperature range and improved start-up characteristics.

Ordering Information

- PT5541□ = +12 Volts
- PT5542□ = +15 Volts
- PT5544□ = +8 Volts
- PT5545□ = +9 Volts
- PT5546□ = +10 Volts
- PT5548□ = +12.6 Volts

Pin-Out Information

Pin	Function
1	V _{IN}
2	GND
3	V _O

PT Series Suffix (PT1234 x)

Case/Pin Configuration	Order Suffix	Package Code
Vertical	N	(EFN)
Horizontal	A	(EFP)
SMD	C	(EFQ)

(Reference the applicable package code drawing for the dimensions and PC board layout)

Standard Application

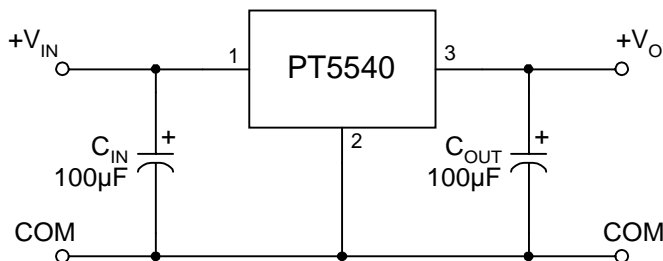

C_{IN} = Required 100µF electrolytic
 C_{OUT} = Required 100µF electrolytic (not to exceed 560µF)

Specifications (Unless otherwise stated, $T_a = 25^\circ\text{C}$, $V_{in} = 5\text{V}$, $C_{in} = 100\mu\text{F}$, $C_{out} = 100\mu\text{F}$, and $I_o = I_{o,max}$)

Characteristics	Symbols	Conditions		PT5540 SERIES			Units
				Min	Typ	Max	
Output Current	I_o	Over V_{in} range	PT5541/8 PT5542 PT5544 PT5545 PT5546	0.1 ⁽¹⁾ 0.1 0.1 0.1 0.1	— — — — —	1 0.75 1.75 1.5 1.3	A
Input Voltage Range	V_{in}	Over I_o range	$V_o > 10\text{V}$ $V_o \leq 10\text{V}$	4.5 4.5	—	9 ($V_o - 1$)	V
Set-Point Voltage Tolerance	$V_o \text{ tol}$			—	—	± 2	$\%V_o$
Temperature Variation	ΔReg_{temp}	$-40^\circ\text{C} < T_a < +85^\circ\text{C}$, $I_o = I_{o,min}$		—	± 0.5	—	$\%V_o$
Line Regulation	ΔReg_{line}	Over V_{in} range		—	—	± 0.5	$\%V_o$
Load Regulation	ΔReg_{load}	Over I_o range		—	—	± 0.5	$\%V_o$
Total Output Variation	ΔReg_{tot}	Includes set-point, line, load, $-40^\circ\text{C} \leq T_a \leq +85^\circ\text{C}$		—	± 3	—	$\%V_o$
Efficiency	η	$I_o = 75\%$ of $I_{o,max}$	PT5541/8 PT5542 PT5544 PT5545 PT5546	— — — — —	84 84 86 86 86	— — — — —	%
V_o Ripple (pk-pk)	V_r	20MHz bandwidth		—	2	5	$\%V_o$
Transient Response	t_{tr} ΔV_{tr}	1A/ μs load step, 50% of $I_{o,max}$ V_o over/undershoot		— —	150 1	— 3	μSec $\%V_o$
Under-Voltage Lockout	UVLO	V_{in} increasing Hysteresis		— 0.1	4.3 0.2	— —	V
Start-up Current	$I_{in,start}$	On start up, $C_{out} = 560\mu\text{F}$		—	$I_{in} + 0.5$	—	A
Switching Frequency	f_o	Over V_{in} and I_o ranges		300	350	400	kHz
External Capacitance	C_{in} C_{out}			100 ⁽³⁾ 100 ⁽³⁾	— —	— 560	μF
Operating Temperature Range	T_a	Over V_{in} range		-40 ⁽⁴⁾	—	$+85$ ⁽⁵⁾	$^\circ\text{C}$
Storage Temperature	T_s			-40	—	$+125$	$^\circ\text{C}$
Mechanical Shock		Per Mil-STD-883D, Method 2002.3, 1 msec, Half Sine, mounted to a fixture		—	500	—	G's
Mechanical Vibration		Per Mil-STD-883D, Method 2007.2, 20-2000 Hz, Soldered in a PC board		—	20 ⁽⁶⁾	—	G's
Weight	—	—		—	6.5	—	grams
Flammability	—	Materials meet UL 94V-0		—	—	—	

- Notes:** (1) The ISR will operate down to no load with reduced specifications.
(2) Boost topology ISRs are not short circuit protected.
(3) The PT5540 Series requires a 100 μF electrolytic or tantalum capacitor at both the input and output for proper operation in all applications.
(4) For operation below 0°C , the output capacitor C_2 must have stable characteristics. Use either a low ESR tantalum or Oscon[®] capacitor.
(5) See SOA curves or consult factory for the appropriate derating.
(6) The case pins on the through-hole package types (suffixes N & A) must be soldered. For more information see the applicable package outline drawing.

PT5541, 12VDC (See Note A)

PT5542, 15VDC (See Note A)

PT5545, 9VDC (See Note A)

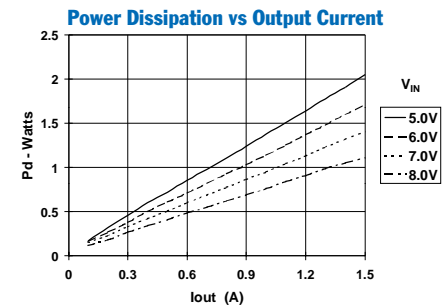
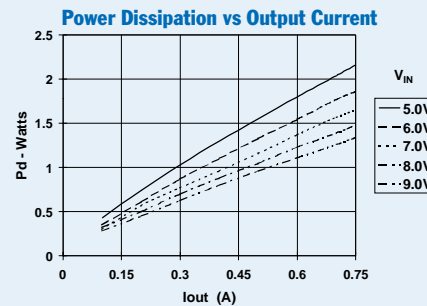
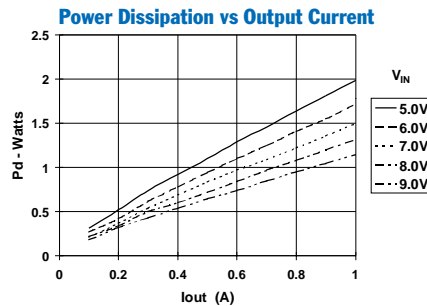
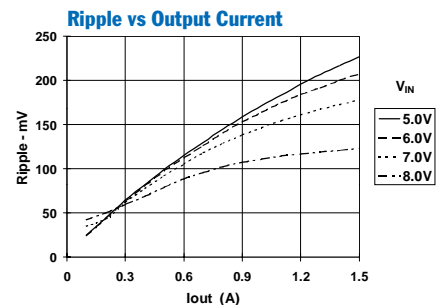
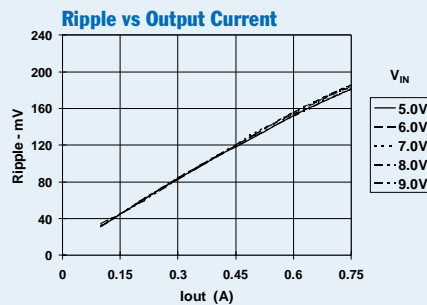
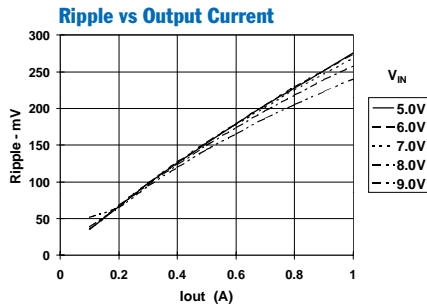
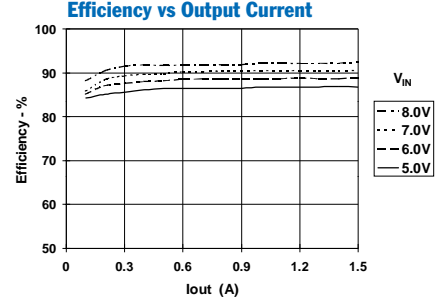
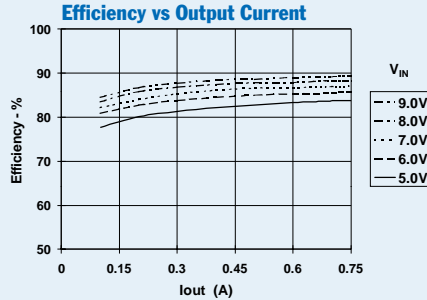
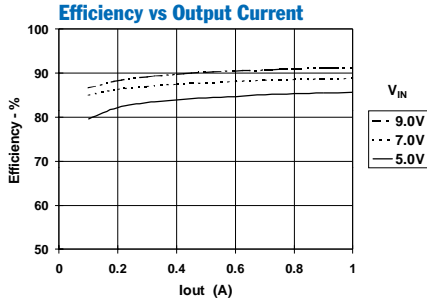

Safe Operating Area; VIN = 5V (See Note B)

Safe Operating Area; VIN = 5V (See Note B)

Safe Operating Area; VIN = 5V (See Note B)

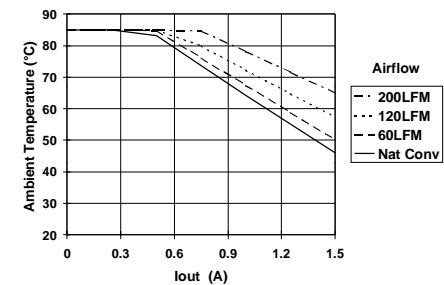
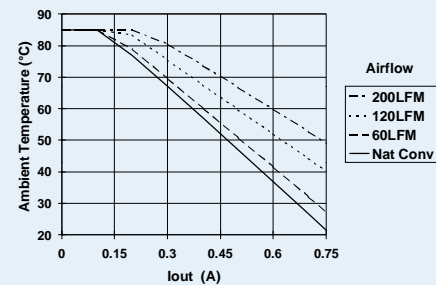
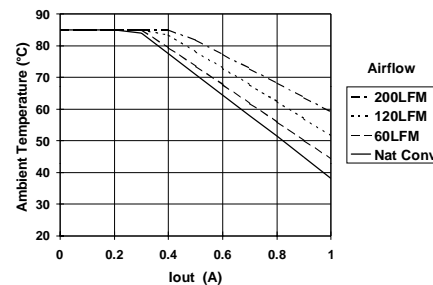

Note A: Characteristic data has been developed from actual products tested at 25°C. This data is considered typical data for the ISR.
Note B: SOA curves represent operating conditions at which internal components are at or below manufacturer's maximum rated operating temperatures.

Capacitor Recommendations for the PT5540 Boost Regulator Regulator Series

Input Capacitors:

The minimum input capacitance required is 100µF, with a 200-mA(rms) ripple current rating and 150mΩ typical equivalent series resistance (ESR). Electrolytic capacitors have marginal ripple performance at frequencies greater than 400kHz but have excellent low-frequency transient response. Above the ripple frequency, ceramic capacitors are necessary to improve the transient response and reduce any high frequency noise components apparent during higher current excursions. Preferred ESR type capacitor part numbers are identified in Table 2-1.

Output Capacitor:

The recommended output capacitance is determined by 0.5-A(rms) ripple current rating and 100µF minimum capacitance. The maximum output capacitance is 560µF.

Ripple current and >50mΩ ESR value are the major considerations, along with temperature, when designing with different types of capacitors. Tantalum capacitors have a recommended minimum voltage rating of 2 × (the maximum DC voltage + AC ripple). This is necessary to insure reliability for input voltage bus applications.

Tantalum Capacitors (Optional Input Capacitors)

Tantalum type capacitors can be used for the input bus but only the AVX TPS, Sprague 593D/594/595, or Kemet T495/T510 series. These capacitors are recommended over many other tantalum types due to their higher rated surge, power dissipation, and ripple current capability. As a caution the TAJ series by AVX is not recommended. This series has considerably higher ESR, reduced power dissipation, and lower ripple current capability. The TAJ series is less reliable than the AVX TPS series when determining power dissipation capability. Tantalum or Oscon® types are recommended for applications where ambient temperatures fall below 0°C. Do not use tantalum capacitors on the output bus.

Capacitor Table

Table 1 identifies the characteristics of capacitors from a number of vendors with acceptable ESR and ripple current ratings. The number of capacitors required at both the input and output buses is identified for each capacitor type.

This is not an extensive capacitor list. Capacitors from other vendors are available with comparable specifications. Those listed are for guidance. The RMS ripple current rating and ESR (Equivalent Series Resistance at 100kHz) are critical parameters necessary to insure both optimum regulator performance and long capacitor life.

Table 1: Input/Output Capacitors

Capacitor Vendor/ Series	Capacitor Characteristics					Quantity		Vendor Part Number
	Working Voltage	Value(µF)	(ESR) Equivalent Series Resistance	105°C Maximum Ripple Current(Irms)	Physical Size(mm)	Input Bus	Output Bus	
Panasonic FC (Radial) (Surface Mtg).....	35V	100	0.117Ω	555mA	8x11.5	1	1	EEUFC1V101
	25V	330	0.090Ω	755mA	10x12.5	1	1	EEUFC1E331
	35V	100	0.150Ω	670mA	10x10.2	1	1	EEVFC1V101P
FC/FK (Surface Mtg)	35V	100	0.160Ω	600mA	8x10.2	1	1	EEVFK1V101P
United Chemi-con LXZ/LXV Series MVY (Surface Mtg)	35V	150	0.120Ω	555mA	8x12	1	1	LXZ35VB151M8X12LL
	25V	220	0.120Ω	555mA	8x12	1	1	LXZ25VB221M8X12LL
	25V	330	0.150Ω	670mA	10x10.3	1	1	MVY25VC331M10X10TP
Nichicon PM Series	35V	120	0.150Ω	555mA	10x12.5	1	1	UPM1V121MPH6
	25V	180	0.150Ω	555mA	10x12.5	1	1	UPM1E181MPH6
NX	16V	150	0.026Ω	3300mA	10x8	1	N/R (1)	PNX1C151MCR1GS
Os-con: SP SVP (surface Mount)	20V	120	0.024Ω	3100mA	8x10.5	1	N/R (1)	20SP120M(No Vout)
	20V	100	0.024Ω	3320mA	8x12	1	N/R (1)	20SVP100M (No Vout)
AVX Tantalum TPS (Surface Mtgt)	16V	100	0.125Ω	>1149mA	7.3L	1	N/R (1)	TPSE107M016R0125(No Vout)
	20V	100	0.200Ω	>1118mA	>5.7W ×4.1H	1	N/R (1)	TPSV107M016R0200 (No Vout)
Kemet Tantalum T520/T495 Series (Surface Mount)	10V	100	0.080Ω	1700mA	4.3W ×7.3L ×4.0H	1	N/R (1)	T520D107M010AS(No Vout)
	10V	100	0.100Ω	>100mA		1	N/R (1)	T495X107M010AS(No Vout)
Sprague Tantalum 594D Series (Surface Mount)	16V	100	0.075Ω	1410mA	7.2L ×6W ×4.1H	1	N/R (1)	594D107X0016D2T

(1) N/R –Not recommended. The surge and normal voltage rating does not meet the minimum operating limits.

Features and System Considerations for the PT5540 Series of Boost ISRs

Boost Regulator Topology and Characteristics

Figure 1-1 shows a block diagram of the boost regulator circuit, which is representative of the PT5540 ISR series. Note that when the MOSFET switch is off, the output regulator is connected directly to the input via an inductor and schottky diode. Thus with the MOSFET switch inactive, the output voltage merely tracks the input voltage, less the forward voltage drop of the diode.

Figure 1-1; Boost Regulator Block Diagram

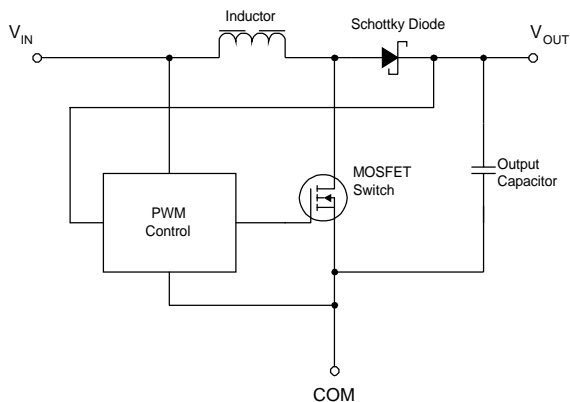

One of the characteristic of a boost regulator is that its input current is always higher than its output current. For example, a 12-W rated 5V to 12V boost regulator, operating at 80% efficiency, will demand 15W of input power. Thus a 1-A load on the regulator's output will correlate to 3-A of input current from its source. And any fall (droop) in the input voltage will correspondingly result in the input current rising further. The input current demanded by a boost regulator is therefore high, making it important that the regulator be connected to a low impedance source.

Under-Voltage Lockout (UVLO)

The PT5540 series of boost regulators incorporate an input under-voltage lockout (UVLO). The UVLO prevents operation of the regulator until the input voltage is above the UVLO threshold (see data sheet specifications). This prevents the regulator from drawing a high startup current during power up, and minimizes the current drain from the input source during low input voltage conditions.

Note: Below the UVLO threshold, the regulator's internal MOSFET is merely held 'off', disabling its boost function. Under this condition the regulator will still produce an output voltage. This is the input voltage less the forward voltage drop of the internal schottky diode.

Soft-Start Power Up

When the input source voltage rises above the UVLO threshold voltage the regulator will initiate a soft-start power up. The soft-start circuitry introduces a short time delay and slows the rate at which the output rises to full regulation voltage. Figure 1-2 shows the power-up characteristic of a PT5542 (15V) regulator. After the application of the input voltage, V_{in} , there is a delay of approximately 100ms before the output voltage rises above the input voltage. This delay provides more time for a slow rising input source to reach the minimum operating voltage of 4.5V. The waveforms of Figure 1-2 were measured with a 5Vdc input voltage and 0.5-Adc constant current load.

Figure 1-2; Typical Power Up Waveforms for the PT5542

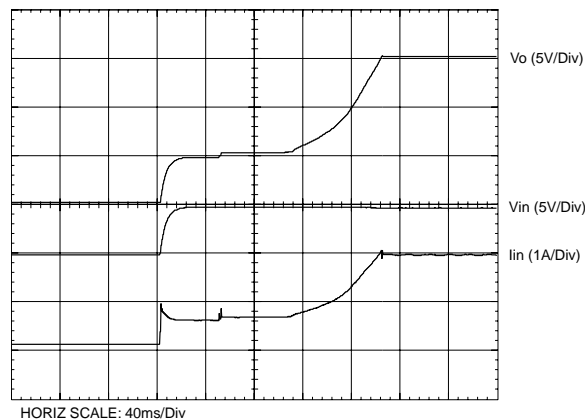

Input Source Requirements

As the input current is much higher than the output load current, boost regulators are sensitive to source voltage impedance. This is especially during power up when a regulator attempts to start at too low an input voltage. The UVLO built into the PT5540 series reduces the input current during startup by disabling the boost function until the source voltage has almost reached the minimum operating voltage of 4.5V. However, the UVLO circuitry will also promptly switch off the regulator if this voltage sags as the input current rises. This is often described as a "hiccup" effect. The module may hiccup at power up due to a combination of two conditions. The input voltage is rising too slowly and its source impedance is not low enough. To ensure a clean power-up the output impedance of the input source should be less than 25m Ω . A higher input impedance can be tolerated if the input voltage rises promptly and regulates closer to the nominal input voltage of 5V.

Fault Protection

Unlike a “Buck” or step-down regulator it is not possible to provide a boost regulator with short-circuit protection. As revealed in the block diagram of Figure 1-1, inhibiting the MOSFET switching action only disables the regulator’s boost function. Therefore under a severe output impedance fault the control circuit cannot disconnect the output from the input source.

To prevent an output over-current or short-circuit fault from propagating to the input bus, a fuse or equivalent over-current protection is recommended at the input of the module. Whatever form of protection is selected, it is important to note that the impedance and/or voltage drop of the series element will add to the regulator’s minimum input voltage requirements. Power up may also be affected. The combination of an input surge current with an impedance in series with the regulator input may cause the input voltage to momentarily dip back below the UVLO threshold. Ensure that the fuse rating or input current limit threshold are designed with a generous margin.

IMPORTANT NOTICE

Texas Instruments Incorporated and its subsidiaries (TI) reserve the right to make corrections, modifications, enhancements, improvements, and other changes to its products and services at any time and to discontinue any product or service without notice. Customers should obtain the latest relevant information before placing orders and should verify that such information is current and complete. All products are sold subject to TI's terms and conditions of sale supplied at the time of order acknowledgment.

TI warrants performance of its hardware products to the specifications applicable at the time of sale in accordance with TI's standard warranty. Testing and other quality control techniques are used to the extent TI deems necessary to support this warranty. Except where mandated by government requirements, testing of all parameters of each product is not necessarily performed.

TI assumes no liability for applications assistance or customer product design. Customers are responsible for their products and applications using TI components. To minimize the risks associated with customer products and applications, customers should provide adequate design and operating safeguards.

TI does not warrant or represent that any license, either express or implied, is granted under any TI patent right, copyright, mask work right, or other TI intellectual property right relating to any combination, machine, or process in which TI products or services are used. Information published by TI regarding third-party products or services does not constitute a license from TI to use such products or services or a warranty or endorsement thereof. Use of such information may require a license from a third party under the patents or other intellectual property of the third party, or a license from TI under the patents or other intellectual property of TI.

Reproduction of information in TI data books or data sheets is permissible only if reproduction is without alteration and is accompanied by all associated warranties, conditions, limitations, and notices. Reproduction of this information with alteration is an unfair and deceptive business practice. TI is not responsible or liable for such altered documentation.

Resale of TI products or services with statements different from or beyond the parameters stated by TI for that product or service voids all express and any implied warranties for the associated TI product or service and is an unfair and deceptive business practice. TI is not responsible or liable for any such statements.

Mailing Address:

Texas Instruments
Post Office Box 655303
Dallas, Texas 75265