

## Low Voltage 1:18 Clock Distribution Chip

The MPC940L is a 1:18 low voltage clock distribution chip with 2.5V or 3.3V LVCMOS output capabilities. The device features the capability to select either a differential LVPECL or an LVCMOS compatible input. The 18 outputs are 2.5V or 3.3V LVCMOS compatible and feature the drive strength to drive 50Ω series or parallel terminated transmission lines. With output-to-output skews of 150ps, the MPC940L is ideal as a clock distribution chip for the most demanding of synchronous systems. The 2.5V outputs also make the device ideal for supplying clocks for a high performance microprocessor based design. For a similar device at a lower price/performance point the reader is referred to the MPC9109.

- LVPECL or LVCMOS Clock Input
- 2.5V LVCMOS Outputs for Pentium II Microprocessor Support
- 150ps Maximum Output-to-Output Skew
- Maximum Output Frequency of 250MHz
- 32-Lead LQFP Packaging
- Dual or Single Supply Device:
  - Dual V<sub>CC</sub> Supply Voltage, 3.3V Core and 2.5V Output
  - Single 3.3V V<sub>CC</sub> Supply Voltage for 3.3V Outputs
  - Single 2.5V V<sub>CC</sub> Supply Voltage for 2.5V I/O

With a low output impedance ( $\approx 20\Omega$ ), in both the HIGH and LOW logic states, the output buffers of the MPC940L are ideal for driving series terminated transmission lines. With a 20Ω output impedance the 940L has the capability of driving two series terminated lines from each output. This gives the device an effective fanout of 1:36. If a lower output impedance is desired please see the MPC942 data sheet.

The differential LVPECL inputs of the MPC940L allow the device to interface directly with a LVPECL fanout buffer like the MC100EP111 to build very wide clock fanout trees or to couple to a high frequency clock source. The LVCMOS input provides a more standard interface for applications requiring only a single clock distribution chip at relatively low frequencies. In addition, the two clock sources can be used to provide for a test clock interface as well as the primary system clock. A logic HIGH on the LVCMOS\_CLK\_Sel pin will select the LVCMOS level clock input. All inputs of the MPC940L have internal pullup/pulldown resistor so they can be left open if unused.

The MPC940L is a single or dual supply device. The device power supply offers a high degree of flexibility. The device can operate with a 3.3V core and 3.3V output, a 3.3V core and 2.5V outputs as well as a 2.5V core and 2.5V outputs. The 32-lead LQFP package was chosen to optimize performance, board space and cost of the device. The 32-lead LQFP has a 7x7mm body size with a conservative 0.8mm pin spacing.

**MPC940L**

**LOW VOLTAGE  
1:18 CLOCK  
DISTRIBUTION CHIP**



**FA SUFFIX**  
32-LEAD LQFP PACKAGE  
CASE 873A-02



LOGIC DIAGRAM



Pinout: 32-Lead TQFP (Top View)

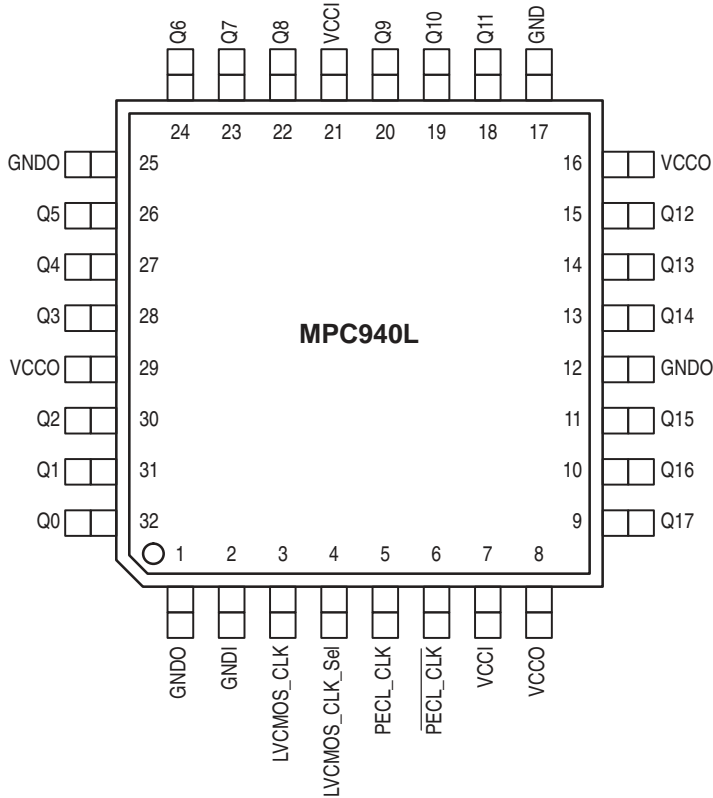

FUNCTION TABLE

LVCOS_CLK_Sel	Input
0	PECL_CLK
1	LVCOS_CLK

POWER SUPPLY VOLTAGES

Supply Pin	Voltage Level
VCCI	2.5V or 3.3V ± 5%
VCCO	2.5V or 3.3V ± 5%

PIN CONFIGURATIONS

Pin	I/O	Type	Function
PECL_CLK PECL_CLK	Input	LVPECL	Reference Clock Input
LVCOS_CLK	Input	LVCOS	Alternative Reference Clock Input
LVCOS_CLK_SEL	Input	LVCOS	Selects Clock Source
Q0-Q17	Output	LVCOS	Clock Outputs
VCCO		Supply	Output Positive Power Supply
VCCI		Supply	Core Positive Power Supply
GND0		Supply	Output Negative Power Supply
GNDI		Supply	Core Negative Power Supply

**ABSOLUTE MAXIMUM RATINGS\***

Symbol	Parameter	Min	Max	Unit
V <sub>CC</sub>	Supply Voltage	-0.3	3.6	V
V <sub>I</sub>	Input Voltage	-0.3	V <sub>DD</sub> + 0.3	V
I <sub>IN</sub>	Input Current		±20	mA
T <sub>Stor</sub>	Storage Temperature Range	-40	125	°C

\* Absolute maximum continuous ratings are those values beyond which damage to the device may occur. Exposure to these conditions or conditions beyond those indicated may adversely affect device reliability. Functional operation under absolute-maximum-rated conditions is not implied.

**DC CHARACTERISTICS** (T<sub>A</sub> = 0° to 70°C, V<sub>CCI</sub> = 3.3V ±5%; V<sub>CCO</sub> = 3.3V ±5%)

Symbol	Characteristic	Min	Typ	Max	Unit	Condition
V <sub>IH</sub>	Input HIGH Voltage CMOS_CLK	2.4		V <sub>CCI</sub>	V	
V <sub>IL</sub>	Input LOW Voltage CMOS_CLK			0.8	V	
V <sub>PP</sub>	Peak-to-Peak Input Voltage PECL_CLK	500		1000	mV	
V <sub>CMR</sub>	Common Mode Range PECL_CLK	V <sub>CC</sub> -1.4		V <sub>CC</sub> -0.6	V	
V <sub>OH</sub>	Output HIGH Voltage	2.4			V	I <sub>OH</sub> = -20mA
V <sub>OL</sub>	Output LOW Voltage			0.5	V	I <sub>OH</sub> = 20mA
I <sub>IN</sub>	Input Current			±200	µA	
C <sub>IN</sub>	Input Capacitance		4.0		pF	
C <sub>pd</sub>	Power Dissipation Capacitance		10		pF	per output
Z <sub>OUT</sub>	Output Impedance	18	23	28	Ω	
I <sub>CC</sub>	Maximum Quiescent Supply Current		0.5	1.0	mA	

**AC CHARACTERISTICS** (T<sub>A</sub> = 0° to 70°C, V<sub>CCI</sub> = 3.3V ±5%; V<sub>CCO</sub> = 3.3V ±5%)

Symbol	Characteristic	Min	Typ	Max	Unit	Condition
F <sub>max</sub>	Maximum Input Frequency			250	MHz	
t <sub>PLH</sub>	Propagation Delay PECL_CLK ≤ 150MHz CMOS_CLK ≤ 150MHz	2.0 1.8	2.7 2.5	3.4 3.0	ns	Note 1.
t <sub>PLH</sub>	Propagation Delay PECL_CLK > 150MHz CMOS_CLK > 150MHz	2.0 1.8	2.9 2.4	3.7 3.2	ns	
t <sub>sk(o)</sub>	Output-to-Output Skew PECL_CLK CMOS_CLK			150 150	ps	Note 1.
t <sub>sk(pp)</sub>	Part-to-Part Skew PECL_CLK < 150MHz CMOS_CLK < 150MHz			1.4 1.2	ns	Notes 1., 2.
t <sub>sk(pp)</sub>	Part-to-Part Skew PECL_CLK > 150MHz CMOS_CLK > 150MHz			1.7 1.4	ns	Notes 1., 2.
t <sub>sk(pp)</sub>	Part-to-Part Skew PECL_CLK CMOS_CLK			850 750	ps	Notes 1., 3.
DC	Output Duty Cycle f <sub>CLK</sub> < 134 MHz f <sub>CLK</sub> ≤ 250 MHz	45 40	50 50	55 60	% %	Input DC = 50% Input DC = 50%
t <sub>r</sub> , t <sub>f</sub>	Output Rise/Fall Time	0.3		1.1	ns	0.5 – 2.4 V

1. Tested using standard input levels, Production tested @ 150MHz.
2. Across temperature and voltage ranges, Includes output skew.
3. For a specific temperature and voltage, Includes output skew.

Freescale Semiconductor, Inc.

**DC CHARACTERISTICS** ( $T_A = 0^\circ$  to  $70^\circ\text{C}$ ,  $V_{CCI} = 3.3\text{V} \pm 5\%$ ;  $V_{CCO} = 2.5\text{V} \pm 5\%$ )

Symbol	Characteristic	Min	Typ	Max	Unit	Condition
$V_{IH}$	Input HIGH Voltage	CMOS_CLK	2.4		$V_{CCI}$	V
$V_{IL}$	Input LOW Voltage	CMOS_CLK			0.8	V
$V_{PP}$	Peak-to-Peak Input Voltage	PECL_CLK	500		1000	mV
$V_{CMR}$	Common Mode Range	PECL_CLK	$V_{CC}-1.4$		$V_{CC}-0.6$	V
$V_{OH}$	Output HIGH Voltage		1.8			V $I_{OH} = -20\text{mA}$
$V_{OL}$	Output LOW Voltage				0.5	V $I_{OH} = 20\text{mA}$
$I_{IN}$	Input Current				$\pm 200$	$\mu\text{A}$
$C_{IN}$	Input Capacitance		4.0			pF
$C_{pd}$	Power Dissipation Capacitance		10			pF per output
$Z_{OUT}$	Output Impedance		23			$\Omega$
$I_{CC}$	Maximum Quiescent Supply Current		0.5	1.0		mA

**AC CHARACTERISTICS** ( $T_A = 0^\circ$  to  $70^\circ\text{C}$ ,  $V_{CCI} = 3.3\text{V} \pm 5\%$ ;  $V_{CCO} = 2.5\text{V} \pm 5\%$ )

Symbol	Characteristic	Min	Typ	Max	Unit	Condition	
$F_{max}$	Maximum Input Frequency			250	MHz		
$t_{PLH}$	Propagation Delay	PECL_CLK $\leq 150\text{MHz}$ CMOS_CLK $\leq 150\text{MHz}$	2.0 1.7	2.8 2.5	3.5 3.0	ns	Note 1.
$t_{PLH}$	Propagation Delay	PECL_CLK $> 150\text{MHz}$ CMOS_CLK $> 150\text{MHz}$	2.0 1.8	2.9 2.5	3.8 3.3	ns	
$t_{sk(o)}$	Output-to-Output Skew	PECL_CLK CMOS_CLK			150 150	ps	Note 1.
$t_{sk(pp)}$	Part-to-Part Skew	PECL_CLK $< 150\text{MHz}$ CMOS_CLK $< 150\text{MHz}$			1.5 1.3	ns	Notes 1., 2.
$t_{sk(pp)}$	Part-to-Part Skew	PECL_CLK $> 150\text{MHz}$ CMOS_CLK $> 150\text{MHz}$			1.8 1.5	ns	Notes 1., 2.
$t_{sk(pp)}$	Part-to-Part Skew	PECL_CLK CMOS_CLK			850 750	ps	Notes 1., 3.
DC	Output Duty Cycle	$f_{CLK} < 134\text{MHz}$ $f_{CLK} \leq 250\text{MHz}$	45 40	50 50	55 60	% %	Input DC = 50% Input DC = 50%
$t_r, t_f$	Output Rise/Fall Time		0.3		1.2	ns	0.5 – 1.8 V

1. Tested using standard input levels, Production tested @ 150MHz.
2. Across temperature and voltage ranges, Includes output skew.
3. For a specific temperature and voltage, Includes output skew.

Freescale Semiconductor, Inc.

**DC CHARACTERISTICS** ( $T_A = 0^\circ$  to  $70^\circ\text{C}$ ,  $V_{CCI} = 2.5\text{V} \pm 5\%$ ;  $V_{CCO} = 2.5\text{V} \pm 5\%$ )

Symbol	Characteristic	Min	Typ	Max	Unit	Condition
$V_{IH}$	Input HIGH Voltage	2.0		$V_{CCI}$	V	
$V_{IL}$	Input LOW Voltage			0.8	V	
$V_{PP}$	Peak-to-Peak Input Voltage	500		1000	mV	
$V_{CMR}$	Common Mode Range	$V_{CC} - 1.0$		$V_{CC} - 0.6$	V	
$V_{OH}$	Output HIGH Voltage	1.8			V	$I_{OH} = -12\text{mA}$
$V_{OL}$	Output LOW Voltage			0.5	V	$I_{OH} = 12\text{mA}$
$I_{IN}$	Input Current			$\pm 200$	$\mu\text{A}$	
$C_{IN}$	Input Capacitance		4.0		pF	
$C_{pd}$	Power Dissipation Capacitance		10		pF	per output
$Z_{OUT}$	Output Impedance	18	23	28	$\Omega$	
$I_{CC}$	Maximum Quiescent Supply Current		0.5	1.0	mA	

**AC CHARACTERISTICS** ( $T_A = 0^\circ$  to  $70^\circ\text{C}$ ,  $V_{CCI} = 2.5\text{V} \pm 5\%$ ;  $V_{CCO} = 2.5\text{V} \pm 5\%$ )

Symbol	Characteristic	Min	Typ	Max	Unit	Condition
$F_{max}$	Maximum Input Frequency			200	MHz	
$t_{PLH}$	Propagation Delay	2.6 2.3	4.0 3.1	5.2 4.0	ns	Note 1.
$t_{PLH}$	Propagation Delay	2.8 2.3	3.8 3.1	5.0 4.0	ns	
$t_{sk(o)}$	Output-to-Output Skew			200 200	ps	Note 1.
$t_{sk(pp)}$	Part-to-Part Skew			2.6 1.7	ns	Notes 1., 2.
$t_{sk(pp)}$	Part-to-Part Skew			2.2 1.7	ns	Notes 1., 2.
$t_{sk(pp)}$	Part-to-Part Skew			1.2 1.0	ns	Notes 1., 3.
DC	Output Duty Cycle	45 40	50 50	55 60	%	Input DC = 50% Input DC = 50%
$t_r, t_f$	Output Rise/Fall Time	0.3		1.2	ns	0.5 – 1.8 V

1. Tested using standard input levels, Production tested @ 150MHz.
2. Across temperature and voltage ranges, Includes output skew.
3. For a specific temperature and voltage, Includes output skew.

Freescale Semiconductor, Inc.

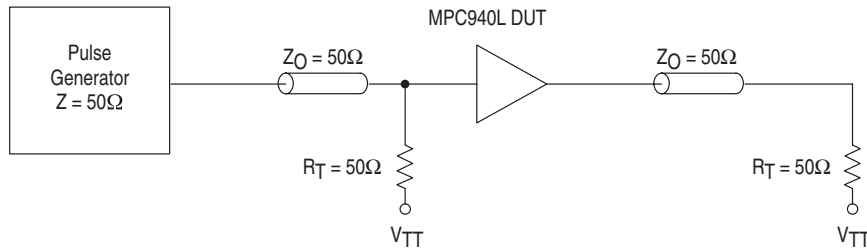

Figure 1. LVC MOS\_CLK MPC940L AC test reference for  $V_{CC} = 3.3V$  and  $V_{CC} = 2.5V$

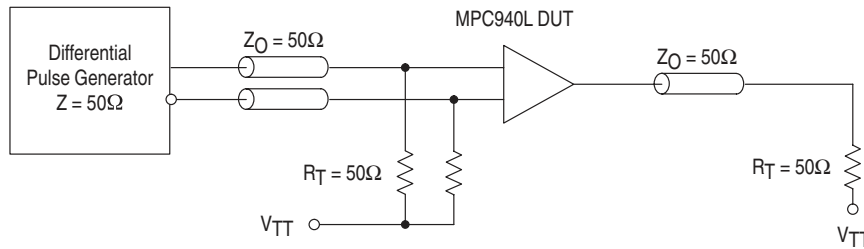

Figure 2. PECL\_CLK MPC940L AC test reference for  $V_{CC} = 3.3V$  and  $V_{CC} = 2.5V$

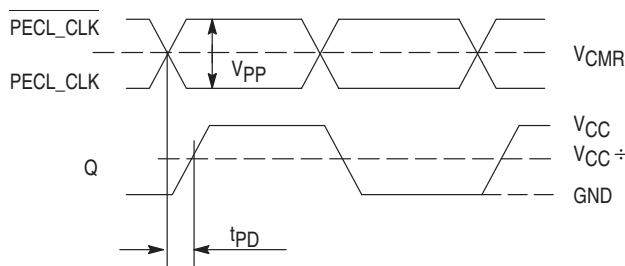

Figure 3. Propagation delay ( $t_{pD}$ ) test reference

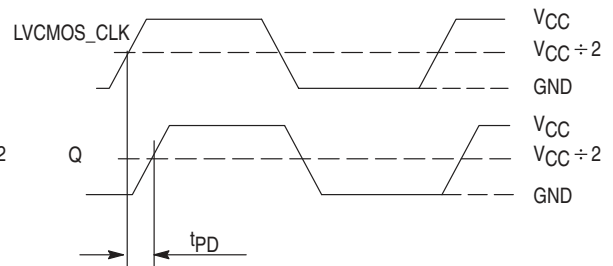
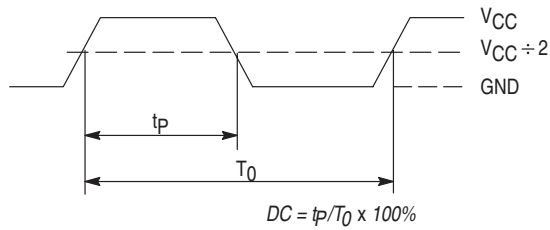
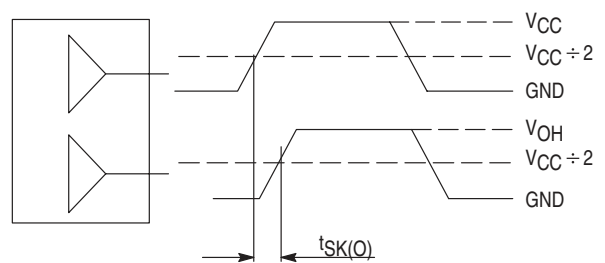

Figure 4. LVC MOS Propagation delay ( $t_{pD}$ ) test reference



The time from the PLL controlled edge to the non controlled edge, divided by the time between PLL controlled edges, expressed as a percentage

Figure 5. Output Duty Cycle (DC)



The pin-to-pin skew is defined as the worst case difference in propagation delay between any two similar delay path within a single device

Figure 6. Output-to-output Skew  $t_{SK}(O)$

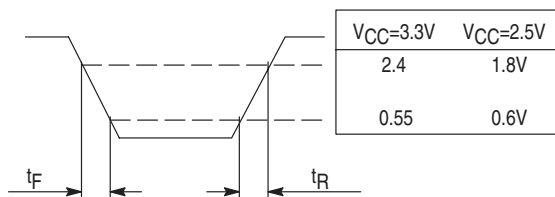

Figure 7. Output Transition Time Test Reference

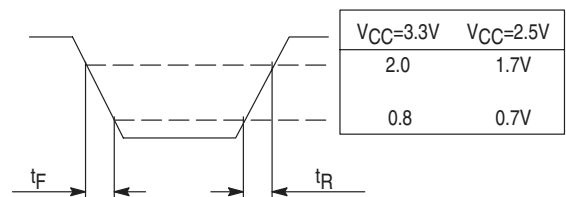
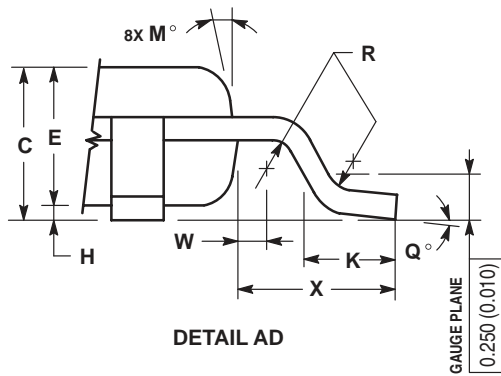
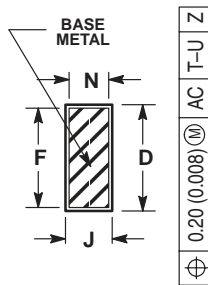
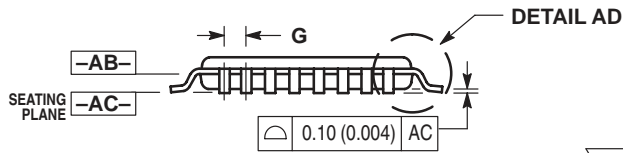
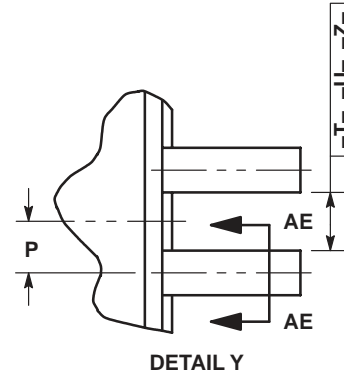
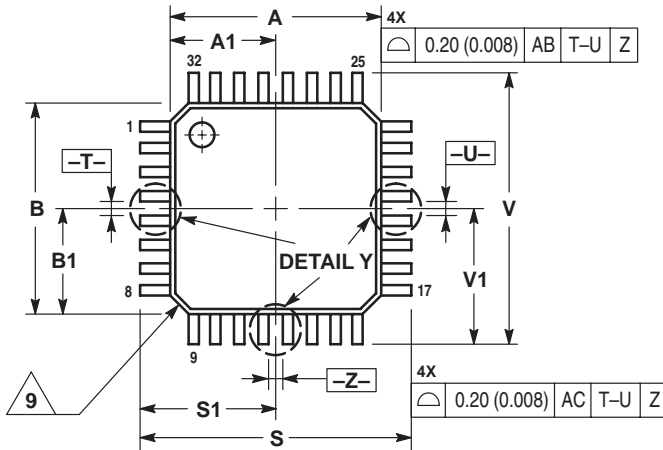

Figure 8. Input Transition Time Test Reference

OUTLINE DIMENSIONS

FA SUFFIX  
QFP PACKAGE  
CASE 873A-02  
ISSUE A



NOTES:

1. DIMENSIONING AND TOLERANCING PER ANSI Y14.5M, 1982.
2. CONTROLLING DIMENSION: MILLIMETER.
3. DATUM PLANE -AB- IS LOCATED AT BOTTOM OF LEAD AND IS COINCIDENT WITH THE LEAD WHERE THE LEAD EXITS THE PLASTIC BODY AT THE BOTTOM OF THE PARTING LINE.
4. DATUMS -T-, -U-, AND -Z- TO BE DETERMINED AT DATUM PLANE -AB-.
5. DIMENSIONS S AND V TO BE DETERMINED AT SEATING PLANE -AC-.
6. DIMENSIONS A AND B DO NOT INCLUDE MOLD PROTRUSION. ALLOWABLE PROTRUSION IS 0.250 (0.010) PER SIDE. DIMENSIONS A AND B DO INCLUDE MOLD MISMATCH AND ARE DETERMINED AT DATUM PLANE -AB-.
7. DIMENSION D DOES NOT INCLUDE DAMBAR PROTRUSION. DAMBAR PROTRUSION SHALL NOT CAUSE THE D DIMENSION TO EXCEED 0.520 (0.020).
8. MINIMUM SOLDER PLATE THICKNESS SHALL BE 0.0076 (0.0003).
9. EXACT SHAPE OF EACH CORNER MAY VARY FROM DEPICTION.

DIM	MILLIMETERS		INCHES	
	MIN	MAX	MIN	MAX
A	7.000 BSC		0.276 BSC	
A1	3.500 BSC		0.138 BSC	
B	7.000 BSC		0.276 BSC	
B1	3.500 BSC		0.138 BSC	
C	1.400	1.600	0.055	0.063
D	0.300	0.450	0.012	0.018
E	1.350	1.450	0.053	0.057
F	0.300	0.400	0.012	0.016
G	0.800 BSC		0.031 BSC	
H	0.050	0.150	0.002	0.006
J	0.090	0.200	0.004	0.008
K	0.500	0.700	0.020	0.028
M	12° REF		12° REF	
N	0.090	0.160	0.004	0.006
P	0.400 BSC		0.016 BSC	
Q	1°	5°	1°	5°
R	0.150	0.250	0.006	0.010
S	9.000 BSC		0.354 BSC	
S1	4.500 BSC		0.177 BSC	
V	9.000 BSC		0.354 BSC	
V1	4.500 BSC		0.177 BSC	
W	0.200 REF		0.008 REF	
X	1.000 REF		0.039 REF	

Motorola reserves the right to make changes without further notice to any products herein. Motorola makes no warranty, representation or guarantee regarding the suitability of its products for any particular purpose, nor does Motorola assume any liability arising out of the application or use of any product or circuit, and specifically disclaims any and all liability, including without limitation consequential or incidental damages. "Typical" parameters which may be provided in Motorola data sheets and/or specifications can and do vary in different applications and actual performance may vary over time. All operating parameters, including "Typicals" must be validated for each customer application by customer's technical experts. Motorola does not convey any license under its patent rights nor the rights of others. Motorola products are not designed, intended, or authorized for use as components in systems intended for surgical implant into the body, or other applications intended to support or sustain life, or for any other application in which the failure of the Motorola product could create a situation where personal injury or death may occur. Should Buyer purchase or use Motorola products for any such unintended or unauthorized application, Buyer shall indemnify and hold Motorola and its officers, employees, subsidiaries, affiliates, and distributors harmless against all claims, costs, damages, and expenses, and reasonable attorney fees arising out of, directly or indirectly, any claim of personal injury or death associated with such unintended or unauthorized use, even if such claim alleges that Motorola was negligent regarding the design or manufacture of the part. Motorola and  are registered trademarks of Motorola, Inc. Motorola, Inc. is an Equal Opportunity/Affirmative Action Employer.

**How to reach us:**

**USA/EUROPE/Locations Not Listed:** Motorola Literature Distribution;  
P.O. Box 5405, Denver, Colorado 80217. 1-303-675-2140 or 1-800-441-2447

**JAPAN:** Motorola Japan Ltd.; SPS, Technical Information Center, 3-20-1,  
Minami-Azabu, Minato-ku, Tokyo 106-8573 Japan. 81-3-3440-3569

**Technical Information Center: 1-800-521-6274**

**ASIA/PACIFIC:** Motorola Semiconductors H.K. Ltd.; Silicon Harbour Centre,  
2, Dai King Street, Tai Po Industrial Estate, Tai Po, N.T., Hong Kong.  
852-26668334

**HOME PAGE:** <http://www.motorola.com/semiconductors/>

**MOTOROLA**

**For More Information On This Product,**  
**Go to: [www.freescale.com](http://www.freescale.com)**

**MPC940L/D**