



# Precision, Micropower, Low-Dropout, High-Output-Current, SOT23 Voltage References

## General Description

The MAX6061–MAX6068 are precision, low-dropout, micropower voltage references. These three-terminal devices are available with output voltage options of 1.25V, 1.8V, 2.048V, 2.5V, 3V, 4.096V, 4.5V, and 5V. They feature a proprietary curvature-correction circuit and laser-trimmed thin-film resistors that result in a very low temperature coefficient of 20ppm/°C (max) and an initial accuracy of  $\pm 0.2\%$  (max). Specifications apply to the extended temperature range ( $-40^{\circ}\text{C}$  to  $+85^{\circ}\text{C}$ ).

The MAX6061–MAX6068 typically draw only 90 $\mu\text{A}$  of supply current and can source 5mA or sink 2mA of load current. Unlike conventional shunt-mode (two-terminal) references that waste supply current and require an external resistor, these devices offer a supply current that is virtually independent of the supply voltage (8 $\mu\text{A}/\text{V}$  variation) and do not require an external resistor. Additionally, the internally compensated devices do not require an external compensation capacitor. Eliminating the external compensation capacitor saves valuable board area in space-critical applications. Low dropout voltage and supply independent, ultra-low supply current make these devices ideal for battery-operated, high-performance, low-voltage systems.

The MAX6061–MAX6068 are available in a 3-pin SOT23 package.

## Applications

Analog-to-Digital Converters (ADCs)  
 Portable Battery-Powered Systems  
 Notebook Computers  
 PDAs, GPSs, DMMs  
 Cellular Phones  
 Precision 3V/5V Systems

Typical Operating Circuit appears at end of data sheet.

## Selector Guide

PART	OUTPUT VOLTAGE (V)	INPUT VOLTAGE (V)
MAX6061	1.248	2.5 to 12.6
MAX6068	1.800	2.5 to 12.6
MAX6062	2.048	2.5 to 12.6
MAX6066	2.500	( $V_{\text{OUT}} + 200\text{mV}$ ) to 12.6
MAX6063	3.000	( $V_{\text{OUT}} + 200\text{mV}$ ) to 12.6
MAX6064	4.096	( $V_{\text{OUT}} + 200\text{mV}$ ) to 12.6
MAX6067	4.500	( $V_{\text{OUT}} + 200\text{mV}$ ) to 12.6
MAX6065	5.000	( $V_{\text{OUT}} + 200\text{mV}$ ) to 12.6



For pricing, delivery, and ordering information, please contact Maxim/Dallas Direct! at 1-888-629-4642, or visit Maxim's website at [www.maxim-ic.com](http://www.maxim-ic.com).

## Features

- ◆ Ultra-Small 3-Pin SOT23 Package
- ◆  $\pm 0.2\%$  (max) Initial Accuracy
- ◆ 20ppm/°C (max) Temperature Coefficient
- ◆ 5mA Source Current
- ◆ 2mA Sink Current
- ◆ No Output Capacitor Required
- ◆ Stable with Capacitive Loads
- ◆ 90 $\mu\text{A}$  (typ) Quiescent Supply Current
- ◆ 200mV (max) Dropout at 1mA Load Current
- ◆ Output Voltage Options: 1.25V, 1.8V, 2.048V, 2.5V, 3V, 4.096V, 4.5V, 5V
- ◆ 13 $\mu\text{Vp-p}$  Noise 0.1Hz to 10Hz (MAX6061)

## Ordering Information

PART	TEMP. RANGE	PIN-PACKAGE	TOP MARK
MAX6061AEUR-T	$-40^{\circ}\text{C}$ to $+85^{\circ}\text{C}$	3 SOT23-3	FZFP
MAX6061BEUR-T	$-40^{\circ}\text{C}$ to $+85^{\circ}\text{C}$	3 SOT23-3	FZFQ
MAX6062AEUR-T	$-40^{\circ}\text{C}$ to $+85^{\circ}\text{C}$	3 SOT23-3	FZFY
MAX6062BEUR-T	$-40^{\circ}\text{C}$ to $+85^{\circ}\text{C}$	3 SOT23-3	FZfZ
MAX6063AEUR-T	$-40^{\circ}\text{C}$ to $+85^{\circ}\text{C}$	3 SOT23-3	FZFV
MAX6063BEUR-T	$-40^{\circ}\text{C}$ to $+85^{\circ}\text{C}$	3 SOT23-3	FZfW
MAX6064AEUR-T	$-40^{\circ}\text{C}$ to $+85^{\circ}\text{C}$	3 SOT23-3	FZGB
MAX6064BEUR-T	$-40^{\circ}\text{C}$ to $+85^{\circ}\text{C}$	3 SOT23-3	FZGC
MAX6065AEUR-T	$-40^{\circ}\text{C}$ to $+85^{\circ}\text{C}$	3 SOT23-3	FZGE
MAX6065BEUR-T	$-40^{\circ}\text{C}$ to $+85^{\circ}\text{C}$	3 SOT23-3	FZGF
MAX6066AEUR-T	$-40^{\circ}\text{C}$ to $+85^{\circ}\text{C}$	3 SOT23-3	FZFM
MAX6066BEUR-T	$-40^{\circ}\text{C}$ to $+85^{\circ}\text{C}$	3 SOT23-3	FZFN

Note: There is a minimum order increment of 2500 pieces for SOT23 packages.

Ordering Information continued at end of data sheet.

## Pin Configuration

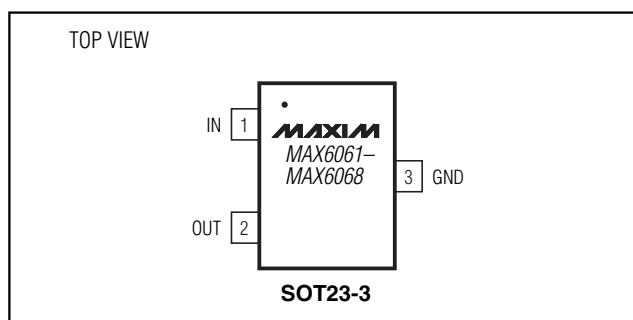

# Precision, Micropower, Low-Dropout, High-Output-Current, SOT23 Voltage References

## ABSOLUTE MAXIMUM RATINGS

(Voltages Referenced to GND)

IN .....	-0.3V to +13.5V
OUT .....	-0.3V to ( $V_{IN} + 0.3V$ )
Output Short-Circuit Duration to GND or IN ( $V_{IN} < 6V$ ) ...Continuous	
Output Short-Circuit Duration to GND or IN ( $V_{IN} \geq 6V$ ) .....	60s

Continuous Power Dissipation ( $T_A = +70^\circ\text{C}$ )

3-Pin SOT23 (derate 4.0mW/ $^\circ\text{C}$ above $+70^\circ\text{C}$ ) .....	320mW
Operating Temperature Range .....	$-40^\circ\text{C}$ to $+85^\circ\text{C}$
Storage Temperature Range .....	$-65^\circ\text{C}$ to $+150^\circ\text{C}$
Lead Temperature (soldering, 10s) .....	$+300^\circ\text{C}$

Stresses beyond those listed under "Absolute Maximum Ratings" may cause permanent damage to the device. These are stress ratings only, and functional operation of the device at these or any other conditions beyond those indicated in the operational sections of the specifications is not implied. Exposure to absolute maximum rating conditions for extended periods may affect device reliability.

## ELECTRICAL CHARACTERISTICS—MAX6061, $V_{OUT} = 1.25V$

( $V_{IN} = +5V$ ,  $I_{OUT} = 0$ ,  $T_A = T_{MIN}$  to  $T_{MAX}$ , unless otherwise noted. Typical values are at  $T_A = +25^\circ\text{C}$ .) (Note 1)

PARAMETER	SYMBOL	CONDITIONS	MIN	TYP	MAX	UNITS	
Output Voltage	$V_{OUT}$	$T_A = +25^\circ\text{C}$	MAX6061A (0.32%)	1.244	1.248	1.252	V
			MAX6061B (0.48%)	1.242	1.248	1.254	
Output Voltage Temperature Coefficient (Note 2)	$TCV_{OUT}$	MAX6061A		6	20	ppm/ $^\circ\text{C}$	
		MAX6061B		6	30		
Line Regulation	$\frac{\Delta V_{OUT}}{\Delta V_{IN}}$	$2.5V \leq V_{IN} \leq 12.6V$		10	90	$\mu\text{V/V}$	
Load Regulation	$\frac{\Delta V_{OUT}}{\Delta I_{OUT}}$	Sourcing: $0 \leq I_{OUT} \leq 5\text{mA}$		0.5	0.9	mV/mA	
		Sinking: $-2\text{mA} \leq I_{OUT} \leq 0$		1.3	3.0		
OUT Short-Circuit Current	$I_{SC}$	Short to GND		25		mA	
		Short to IN		25			
Long-Term Stability	$\frac{\Delta V_{OUT}}{\text{time}}$	1000hr at $+25^\circ\text{C}$		62		ppm/1000hr	
Output Voltage Hysteresis (Note 3)	$\frac{\Delta V_{OUT}}{\text{cycle}}$			130		ppm	
<b>DYNAMIC CHARACTERISTICS</b>							
Noise Voltage	$e_{OUT}$	$f = 0.1\text{Hz}$ to $10\text{Hz}$		13		$\mu\text{Vp-p}$	
		$f = 10\text{Hz}$ to $10\text{kHz}$		15		$\mu\text{VRMS}$	
Ripple Rejection	$\frac{\Delta V_{OUT}}{\Delta V_{IN}}$	$V_{IN} = 5V \pm 100\text{mV}$ , $f = 120\text{Hz}$		86		dB	
Turn-On Settling Time	$t_R$	To $V_{OUT} = 0.1\%$ of final value, $C_{OUT} = 50\text{pF}$		50		$\mu\text{s}$	
<b>INPUT CHARACTERISTICS</b>							
Supply Voltage Range	$V_{IN}$	Guaranteed by line regulation test	2.5		12.6	V	
Quiescent Supply Current	$I_{IN}$			90	125	$\mu\text{A}$	
Change in Supply Current	$\frac{\Delta I_{IN}}{\Delta V_{IN}}$	$2.5V \leq V_{IN} \leq 12.6V$		3.4	8.0	$\mu\text{A/V}$	

# Precision, Micropower, Low-Dropout, High-Output-Current, SOT23 Voltage References

## ELECTRICAL CHARACTERISTICS—MAX6068, $V_{OUT} = 1.80V$

( $V_{IN} = +5V$ ,  $T_A = T_{MIN}$  to  $T_{MAX}$ , unless otherwise noted. Typical values are at  $T_A = +25^\circ C$ .) (Note 1)

PARAMETER	SYMBOL	CONDITIONS	MIN	TYP	MAX	UNITS	
Output Voltage	$V_{OUT}$	$T_A = +25^\circ C$	MAX6068A (0.17%)	1.797	1.800	1.803	V
			MAX6068B (0.39%)	1.793	1.800	1.807	
Output Voltage Temperature Coefficient (Note 2)	$TCV_{OUT}$	MAX6068A		6	20	ppm/ $^\circ C$	
		MAX6068B		6	30		
Line Regulation	$\frac{\Delta V_{OUT}}{\Delta V_{IN}}$	$2.5V \leq V_{IN} \leq 12.6V$		33	200	$\mu V/V$	
Load Regulation	$\frac{\Delta V_{OUT}}{\Delta I_{OUT}}$	Sourcing: $0 \leq I_{OUT} \leq 5mA$		0.5	0.9	mV/mA	
		Sinking: $-2mA \leq I_{OUT} \leq 0$		1.5	4		
OUT Short-Circuit Current	$I_{SC}$	Short to GND		25		mA	
		Short to IN		25			
Long-Term Stability	$\frac{\Delta V_{OUT}}{\text{time}}$	1000hr at $+25^\circ C$		62		ppm/1000hr	
Output Voltage Hysteresis (Note 3)	$\frac{\Delta V_{OUT}}{\text{cycle}}$			130		ppm	
<b>DYNAMIC CHARACTERISTICS</b>							
Noise Voltage	$e_{OUT}$	$f = 0.1Hz$ to $10Hz$		22		$\mu V_{p-p}$	
		$f = 10Hz$ to $10kHz$		25		$\mu V_{RMS}$	
Ripple Rejection	$\frac{\Delta V_{OUT}}{\Delta V_{IN}}$	$V_{IN} = 5V \pm 100mV$ , $f = 120Hz$		86		dB	
Turn-On Settling Time	$t_R$	To $V_{OUT} = 0.1\%$ of final value, $C_{OUT} = 50pF$		115		$\mu s$	
<b>INPUT CHARACTERISTICS</b>							
Supply Voltage Range	$V_{IN}$	Guaranteed by line regulation test	2.5		12.6	V	
Quiescent Supply Current	$I_{IN}$			90	125	$\mu A$	
Change in Supply Current	$\frac{\Delta I_{IN}}{\Delta V_{IN}}$	$2.5V \leq V_{IN} \leq 12.6V$		3.3	8.0	$\mu A/V$	

**MAX6061-MAX6068**

# Precision, Micropower, Low-Dropout, High-Output-Current, SOT23 Voltage References

## ELECTRICAL CHARACTERISTICS—MAX6062, $V_{OUT} = 2.048V$

( $V_{IN} = +5V$ ,  $I_{OUT} = 0$ ,  $T_A = T_{MIN}$  to  $T_{MAX}$ , unless otherwise noted. Typical values are at  $T_A = +25^\circ C$ .) (Note 1)

PARAMETER	SYMBOL	CONDITIONS	MIN	TYP	MAX	UNITS	
Output Voltage	$V_{OUT}$	$T_A = +25^\circ C$	MAX6062A (0.24%)	2.043	2.048	2.053	V
			MAX6062B (0.39%)	2.040	2.048	2.056	
Output Voltage Temperature Coefficient (Note 2)	$TCV_{OUT}$	MAX6062A		6	20	ppm/ $^\circ C$	
		MAX6062B		6	30		
Line Regulation	$\frac{\Delta V_{OUT}}{\Delta V_{IN}}$	$2.5V \leq V_{IN} \leq 12.6V$		33	200	$\mu V/V$	
Load Regulation	$\frac{\Delta V_{OUT}}{\Delta I_{OUT}}$	Sourcing: $0 \leq I_{OUT} \leq 5mA$		0.5	0.9	mV/mA	
		Sinking: $-2mA \leq I_{OUT} \leq 0$		1.5	4		
OUT Short-Circuit Current	$I_{SC}$	Short to GND		25		mA	
		Short to IN		25			
Long-Term Stability	$\frac{\Delta V_{OUT}}{\text{time}}$	1000hr at $+25^\circ C$		62		ppm/1000hr	
Output Voltage Hysteresis (Note 3)	$\frac{\Delta V_{OUT}}{\text{cycle}}$			130		ppm	
<b>DYNAMIC CHARACTERISTICS</b>							
Noise Voltage	$e_{OUT}$	$f = 0.1Hz$ to $10Hz$		22		$\mu V_{p-p}$	
		$f = 10Hz$ to $10kHz$		25		$\mu V_{RMS}$	
Ripple Rejection	$\frac{\Delta V_{OUT}}{\Delta V_{IN}}$	$V_{IN} = 5V \pm 100mV$ , $f = 120Hz$		86		dB	
Turn-On Settling Time	$t_R$	To $V_{OUT} = 0.1\%$ of final value, $C_{OUT} = 50pF$		115		$\mu s$	
<b>INPUT CHARACTERISTICS</b>							
Supply Voltage Range	$V_{IN}$	Guaranteed by line-regulation test	2.5		12.6	V	
Quiescent Supply Current	$I_{IN}$			90	125	$\mu A$	
Change in Supply Current	$I_{IN}/V_{IN}$	$2.5V \leq V_{IN} \leq 12.6V$		3.3	8.0	$\mu A/V$	

# Precision, Micropower, Low-Dropout, High-Output-Current, SOT23 Voltage References

## ELECTRICAL CHARACTERISTICS—MAX6066, V<sub>OUT</sub> = 2.500V

(V<sub>IN</sub> = +5V, I<sub>OUT</sub> = 0, T<sub>A</sub> = T<sub>MIN</sub> to T<sub>MAX</sub>, unless otherwise noted. Typical values are at T<sub>A</sub> = +25°C.) (Note 1)

PARAMETER	SYMBOL	CONDITIONS	MIN	TYP	MAX	UNITS	
Output Voltage	V <sub>OUT</sub>	T <sub>A</sub> = +25°C	MAX6066A (0.2%)	2.495	2.500	2.505	V
			MAX6066B (0.4%)	2.490	2.500	2.510	
Output Voltage Temperature Coefficient (Note 2)	TCV <sub>OUT</sub>	MAX6066A		6	20	ppm/°C	
		MAX6066B		6	30		
Line Regulation	$\frac{\Delta V_{OUT}}{\Delta V_{IN}}$	(V <sub>OUT</sub> + 0.2V) ≤ V <sub>IN</sub> ≤ 12.6V		60	300	μV/V	
Load Regulation	$\frac{\Delta V_{OUT}}{\Delta I_{OUT}}$	Sourcing: 0 ≤ I <sub>OUT</sub> ≤ 5mA		0.5	0.9	mV/mA	
		Sinking: -2mA ≤ I <sub>OUT</sub> ≤ 0		1.6	5		
Dropout Voltage (Note 4)	$\frac{V_{IN} - V_{OUT}}$	I <sub>OUT</sub> = 1mA		50	200	mV	
OUT Short-Circuit Current	I <sub>SC</sub>	Short to GND		25		mA	
		Short to IN		25			
Long-Term Stability	$\frac{\Delta V_{OUT}}{\text{time}}$	1000hr at +25°C		62		ppm/1000hr	
Output Voltage Hysteresis (Note 3)	$\frac{\Delta V_{OUT}}{\text{cycle}}$			130		ppm	
<b>DYNAMIC CHARACTERISTICS</b>							
Noise Voltage	e <sub>OUT</sub>	f = 0.1Hz to 10Hz		27		μVp-p	
		f = 10Hz to 10kHz		30		μV <sub>RMS</sub>	
Ripple Rejection	$\frac{\Delta V_{OUT}}{\Delta V_{IN}}$	V <sub>IN</sub> = 5V ± 100mV, f = 120Hz		86		dB	
Turn-On Settling Time	t <sub>R</sub>	To V <sub>OUT</sub> = 0.1% of final value, C <sub>OUT</sub> = 50pF		115		μs	
<b>INPUT CHARACTERISTICS</b>							
Supply Voltage Range	V <sub>IN</sub>	Guaranteed by line-regulation test		V <sub>OUT</sub> + 0.2	12.6	V	
Quiescent Supply Current	I <sub>IN</sub>			90	125	μA	
Change in Supply Current	I <sub>IN</sub> /V <sub>IN</sub>	(V <sub>OUT</sub> + 0.2V) ≤ V <sub>IN</sub> ≤ 12.6V		3.3	8.0	μA/V	

MAX60661-MAX60668

# Precision, Micropower, Low-Dropout, High-Output-Current, SOT23 Voltage References

## ELECTRICAL CHARACTERISTICS—MAX6063, $V_{OUT} = 3.0V$

( $V_{IN} = +5V$ ,  $I_{OUT} = 0$ ,  $T_A = T_{MIN}$  to  $T_{MAX}$ , unless otherwise noted. Typical values are at  $T_A = +25^\circ C$ .) (Note 1)

PARAMETER	SYMBOL	CONDITIONS	MIN	TYP	MAX	UNITS	
Output Voltage	$V_{OUT}$	$T_A = +25^\circ C$	MAX6063A (0.2%)	2.994	3.000	3.006	V
			MAX6063B (0.4%)	2.988	3.000	3.012	
Output Voltage Temperature Coefficient (Note 2)	$TCV_{OUT}$	MAX6063A		6	20	ppm/ $^\circ C$	
		MAX6063B		6	30		
Line Regulation	$\frac{\Delta V_{OUT}}{\Delta V_{IN}}$	$(V_{OUT} + 0.2V) \leq V_{IN} \leq 12.6V$		90	400	$\mu V/V$	
Load Regulation	$\frac{\Delta V_{OUT}}{\Delta I_{OUT}}$	Sourcing: $0 \leq I_{OUT} \leq 5mA$		0.5	0.9	mV/mA	
		Sinking: $-2mA \leq I_{OUT} \leq 0$		2.0	6.0		
Dropout Voltage (Note 4)	$V_{IN} - V_{OUT}$	$I_{OUT} = 1mA$		50	200	mV	
OUT Short-Circuit Current	$I_{SC}$	Short to GND		25		mA	
		Short to IN		25			
Long-Term Stability	$\frac{\Delta V_{OUT}}{\text{time}}$	1000hr at $+25^\circ C$		62		ppm/1000hr	
Output Voltage Hysteresis (Note 3)	$\frac{\Delta V_{OUT}}{\text{cycle}}$			130		ppm	
<b>DYNAMIC CHARACTERISTICS</b>							
Noise Voltage	$e_{OUT}$	$f = 0.1Hz$ to $10Hz$		35		$\mu V_{p-p}$	
		$f = 10Hz$ to $10kHz$		40		$\mu V_{RMS}$	
Ripple Rejection	$\frac{\Delta V_{OUT}}{\Delta V_{IN}}$	$V_{IN} = 5V \pm 100mV$ , $f = 120Hz$		76		dB	
Turn-On Settling Time	$t_R$	To $V_{OUT} = 0.1\%$ of final value, $C_{OUT} = 50pF$		115		$\mu s$	
<b>INPUT CHARACTERISTICS</b>							
Supply Voltage Range	$V_{IN}$	Guaranteed by line-regulation test		$V_{OUT} + 0.2$	12.6	V	
Quiescent Supply Current	$I_{IN}$			90	125	$\mu A$	
Change in Supply Current	$I_{IN}/V_{IN}$	$(V_{OUT} + 0.2V) \leq V_{IN} \leq 12.6V$		3.4	8.0	$\mu A/V$	

# Precision, Micropower, Low-Dropout, High-Output-Current, SOT23 Voltage References

**MAX6061-MAX6068**

## ELECTRICAL CHARACTERISTICS—MAX6064, V<sub>OUT</sub> = 4.096V

(V<sub>IN</sub> = +5V, I<sub>OUT</sub> = 0, T<sub>A</sub> = T<sub>MIN</sub> to T<sub>MAX</sub>, unless otherwise noted. Typical values are at T<sub>A</sub> = +25°C.) (Note 1)

PARAMETER	SYMBOL	CONDITIONS	MIN	TYP	MAX	UNITS	
Output Voltage	V <sub>OUT</sub>	T <sub>A</sub> = +25°C	MAX6064A (0.2%)	4.088	4.096	4.104	V
			MAX6064B (0.4%)	4.080	4.096	4.112	
Output Voltage Temperature Coefficient (Note 2)	TCV <sub>OUT</sub>	MAX6064A		6	20	ppm/°C	
		MAX6064B		6	30		
Line Regulation	$\frac{\Delta V_{OUT}}{\Delta V_{IN}}$	(V <sub>OUT</sub> + 0.2V) ≤ V <sub>IN</sub> ≤ 12.6V		130	430	μV/V	
Load Regulation	$\frac{\Delta V_{OUT}}{\Delta I_{OUT}}$	Sourcing: 0 ≤ I <sub>OUT</sub> ≤ 5mA		0.5	0.9	mV/mA	
		Sinking: -2mA ≤ I <sub>OUT</sub> ≤ 0		2.2	8		
Dropout Voltage (Note 4)	$\frac{V_{IN} - V_{OUT}}$	I <sub>OUT</sub> = 1mA		50	200	mV	
OUT Short-Circuit Current	I <sub>SC</sub>	Short to GND		25		mA	
		Short to I <sub>N</sub>		25			
Long-Term Stability	$\frac{\Delta V_{OUT}}{\text{time}}$	1000hr at +25°C		62		ppm/1000hr	
Output Voltage Hysteresis (Note 3)	$\frac{\Delta V_{OUT}}{\text{cycle}}$			130		ppm	
<b>DYNAMIC CHARACTERISTICS</b>							
Noise Voltage	e <sub>OUT</sub>	f = 0.1Hz to 10Hz		50		μVp-p	
		f = 10Hz to 10kHz		50		μV <sub>RMS</sub>	
Ripple Rejection	$\frac{\Delta V_{OUT}}{\Delta V_{IN}}$	V <sub>IN</sub> = 5V ±100mV, f = 120Hz		72		dB	
Turn-On Settling Time	t <sub>R</sub>	To V <sub>OUT</sub> = 0.1% of final value, C <sub>OUT</sub> = 50pF		190		μs	
<b>INPUT CHARACTERISTICS</b>							
Supply Voltage Range	V <sub>IN</sub>	Guaranteed by line-regulation test	V <sub>OUT</sub> + 0.2		12.6	V	
Quiescent Supply Current	I <sub>IN</sub>			90	125	μA	
Change in Supply Current	I <sub>IN</sub> /V <sub>IN</sub>	(V <sub>OUT</sub> + 0.2V) ≤ V <sub>IN</sub> ≤ 12.6V		3.2	8.0	μA/V	

# Precision, Micropower, Low-Dropout, High-Output-Current, SOT23 Voltage References

## ELECTRICAL CHARACTERISTICS—MAX6067, $V_{OUT} = 4.500V$

( $V_{IN} = +5V$ ,  $I_{OUT} = 0$ ,  $T_A = T_{MIN}$  to  $T_{MAX}$ , unless otherwise noted. Typical values are at  $T_A = +25^\circ C$ .) (Note 1)

PARAMETER	SYMBOL	CONDITIONS	MIN	TYP	MAX	UNITS	
Output Voltage	$V_{OUT}$	$T_A = +25^\circ C$	MAX6067A (0.2%)	4.491	4.500	4.509	V
			MAX6067B (0.4%)	4.482	4.500	4.518	
Output Voltage Temperature Coefficient (Note 2)	$TCV_{OUT}$	MAX6067A		6	20	ppm/ $^\circ C$	
		MAX6067B		6	30		
Line Regulation	$\frac{\Delta V_{OUT}}{\Delta V_{IN}}$	$(V_{OUT} + 0.2V) \leq V_{IN} \leq 12.6V$		170	550	$\mu V/V$	
Load Regulation	$\frac{\Delta V_{OUT}}{\Delta I_{OUT}}$	Sourcing: $0 \leq I_{OUT} \leq 5mA$		0.5	0.9	mV/mA	
		Sinking: $-2mA \leq I_{OUT} \leq 0$		2.4	8		
Dropout Voltage (Note 4)	$V_{IN} - V_{OUT}$	$I_{OUT} = 1mA$		50	200	mV	
OUT Short-Circuit Current	$I_{SC}$	Short to GND		25		mA	
		Short to IN		25			
Long-Term Stability	$\frac{\Delta V_{OUT}}{\text{time}}$	1000hr at $+25^\circ C$		62		ppm/ 1000hr	
Output Voltage Hysteresis (Note 3)	$\frac{\Delta V_{OUT}}{\text{cycle}}$			130		ppm	
<b>DYNAMIC CHARACTERISTICS</b>							
Noise Voltage	$e_{OUT}$	$f = 0.1Hz$ to $10Hz$		55		$\mu Vp-p$	
		$f = 10Hz$ to $10kHz$		55		$\mu VRMS$	
Ripple Rejection	$\frac{\Delta V_{OUT}}{\Delta V_{IN}}$	$V_{IN} = 5V \pm 100mV$ , $f = 120Hz$		70		dB	
Turn-On Settling Time	$t_R$	To $V_{OUT} = 0.1\%$ of final value, $C_{OUT} = 50pF$		230		$\mu s$	
<b>INPUT CHARACTERISTICS</b>							
Supply Voltage Range	$V_{IN}$	Guaranteed by line-regulation test		$V_{OUT} + 0.2$	12.6	V	
Quiescent Supply Current	$I_{IN}$			90	125	$\mu A$	
Change in Supply Current	$I_{IN}/V_{IN}$	$(V_{OUT} + 0.2V) \leq V_{IN} \leq 12.6V$		3.2	8.0	$\mu A/V$	



# Precision, Micropower, Low-Dropout, High-Output-Current, SOT23 Voltage References

MAX6061-MAX6068

## ELECTRICAL CHARACTERISTICS—MAX6065, V<sub>OUT</sub> = 5.000V

(V<sub>IN</sub> = +5.2V, I<sub>OUT</sub> = 0, T<sub>A</sub> = T<sub>MIN</sub> to T<sub>MAX</sub>, unless otherwise noted. Typical values are at T<sub>A</sub> = +25°C.) (Note 1)

PARAMETER	SYMBOL	CONDITIONS	MIN	TYP	MAX	UNITS	
Output Voltage	V <sub>OUT</sub>	T <sub>A</sub> = +25°C	MAX6065A (0.2%)	4.990	5.000	5.010	V
			MAX6065B (0.4%)	4.980	5.000	5.020	
Output Voltage Temperature Coefficient (Note 2)	TCV <sub>OUT</sub>	MAX6065A		6	20	ppm/°C	
		MAX6065B		6	30		
Line Regulation	$\frac{\Delta V_{OUT}}{\Delta V_{IN}}$	(V <sub>OUT</sub> + 0.2V) ≤ V <sub>IN</sub> ≤ 12.6V		180	550	μV/V	
Load Regulation	$\frac{\Delta V_{OUT}}{\Delta I_{OUT}}$	Sourcing: 0 ≤ I <sub>OUT</sub> ≤ 5mA		0.5	0.9	mV/mA	
		Sinking: -2mA ≤ I <sub>OUT</sub> ≤ 0		2.4	8.0		
Dropout Voltage (Note 4)	$\frac{V_{IN} - V_{OUT}}$	I <sub>OUT</sub> = 1mA		50	200	mV	
OUT Short-Circuit Current	I <sub>SC</sub>	Short to GND		25		mA	
		Short to IN		25			
Long-Term Stability	$\frac{\Delta V_{OUT}}{\text{time}}$	1000hr at +25°C		62		ppm/1000hr	
Output Voltage Hysteresis (Note 3)	$\frac{\Delta V_{OUT}}{\text{cycle}}$			130		ppm	
<b>DYNAMIC CHARACTERISTICS</b>							
Noise Voltage	e <sub>OUT</sub>	f = 0.1Hz to 10Hz		60		μVp-p	
		f = 10Hz to 10kHz		60		μVRMS	
Ripple Rejection	$\frac{\Delta V_{OUT}}{\Delta V_{IN}}$	V <sub>IN</sub> = 5V ±100mV, f = 120Hz		65		dB	
Turn-On Settling Time	t <sub>R</sub>	To V <sub>OUT</sub> = 0.1% of final value, C <sub>OUT</sub> = 50pF		300		μs	
<b>INPUT CHARACTERISTICS</b>							
Supply Voltage Range	V <sub>IN</sub>	Guaranteed by line-regulation test		V <sub>OUT</sub> + 0.2	12.6	V	
Quiescent Supply Current	I <sub>IN</sub>			90	125	μA	
Change in Supply Current	I <sub>IN</sub> /V <sub>IN</sub>	(V <sub>OUT</sub> + 0.2V) ≤ V <sub>IN</sub> ≤ 12.6V		3.2	8.0	μA/V	

**Note 1:** All devices are 100% production tested at T<sub>A</sub> = +25°C and are guaranteed by design for T<sub>A</sub> = T<sub>MIN</sub> to T<sub>MAX</sub>, as specified.

**Note 2:** Temperature Coefficient is measured by the “box” method, i.e., the maximum ΔV<sub>OUT</sub> is divided by the maximum ΔT.

**Note 3:** Temperature Hysteresis is defined as the change in +25°C output voltage before and after cycling the device from T<sub>MIN</sub> to T<sub>MAX</sub>.

**Note 4:** Dropout voltage is the minimum input voltage at which V<sub>OUT</sub> changes ≤ 0.2% from V<sub>OUT</sub> at V<sub>IN</sub> = 5.0V (V<sub>IN</sub> = 5.5V for MAX6065).

# Precision, Micropower, Low-Dropout, High-Output-Current, SOT23 Voltage References

## Typical Operating Characteristics

( $V_{IN} = +5V$  for MAX6061-MAX6068,  $V_{IN} = +5.5V$  for MAX6065,  $I_{OUT} = 0$ ,  $T_A = +25^\circ C$ , unless otherwise noted.) (Note 5)

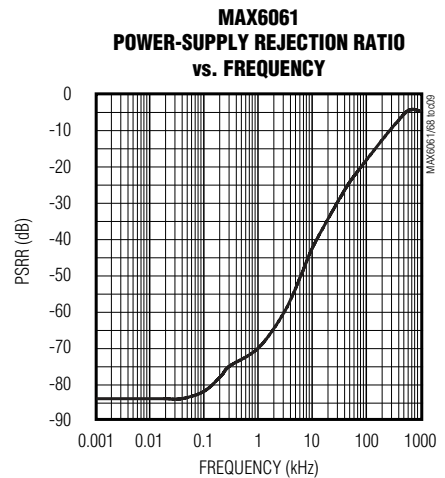
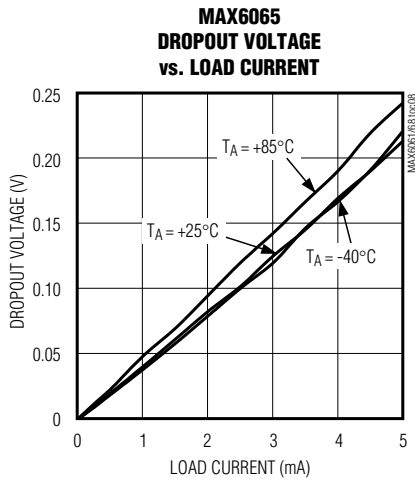
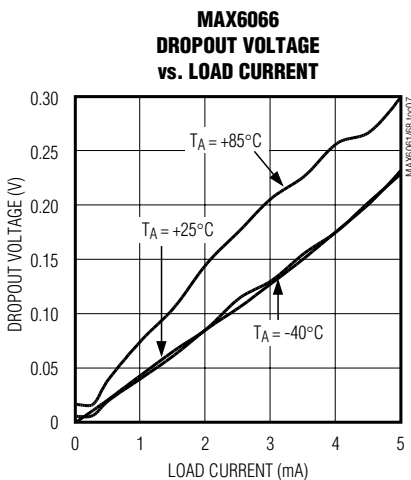
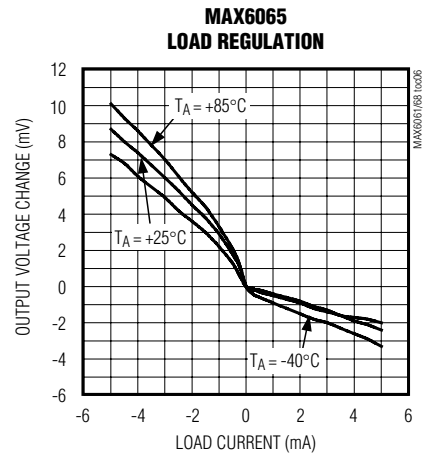
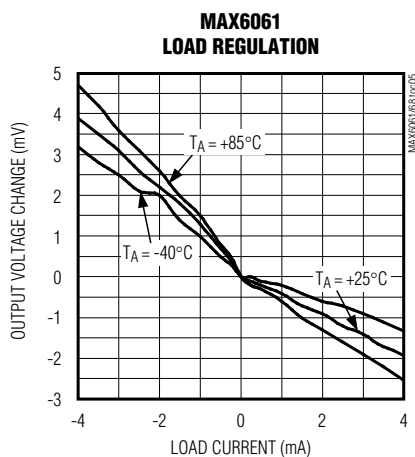
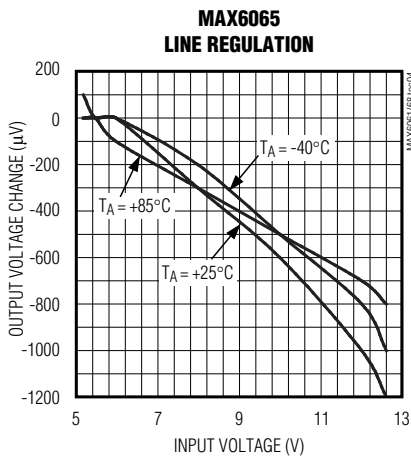
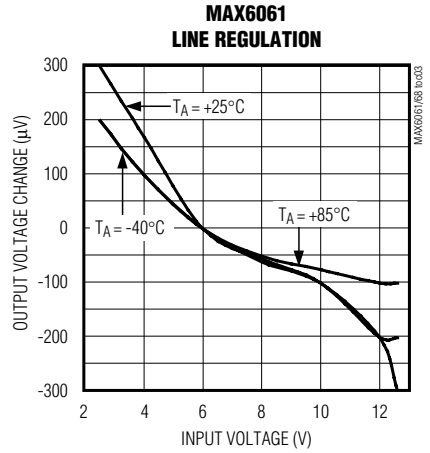
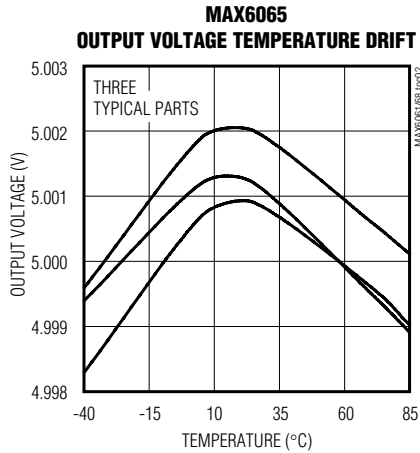
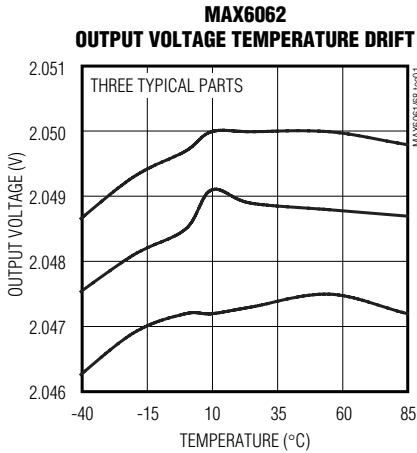

# Precision, Micropower, Low-Dropout, High-Output-Current, SOT23 Voltage References

## Typical Operating Characteristics (continued)

( $V_{IN} = +5V$  for MAX6061–MAX6068,  $V_{IN} = +5.5V$  for MAX6065,  $I_{OUT} = 0$ ,  $T_A = +25^\circ C$ , unless otherwise noted.) (Note 5)

MAX6061–MAX6068

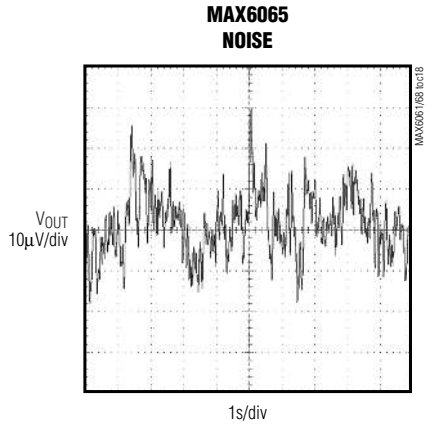
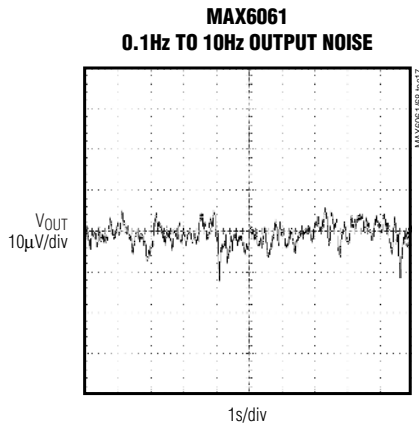
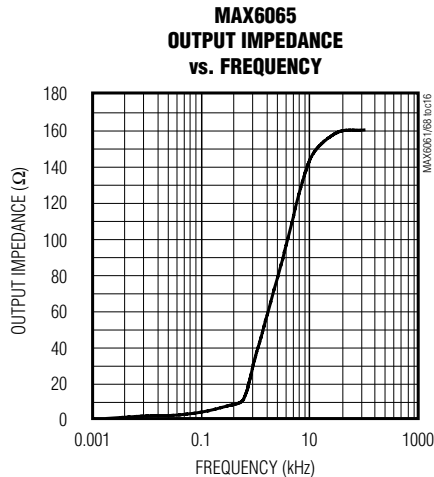
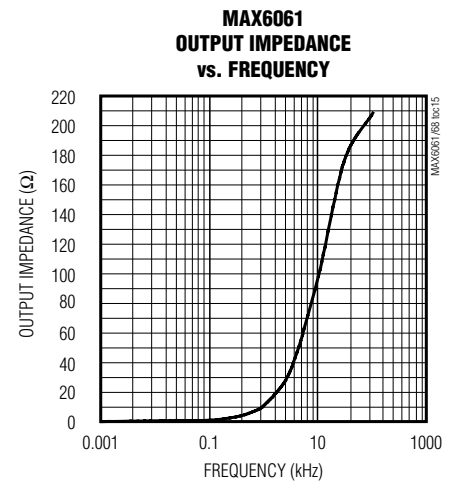
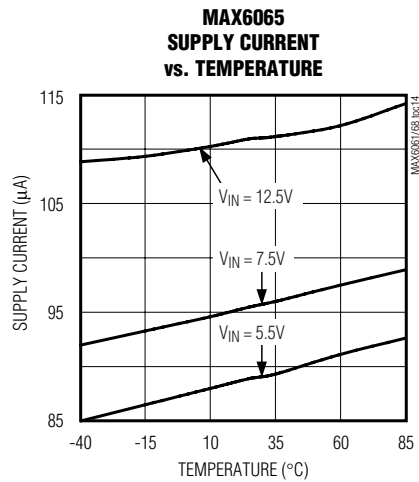
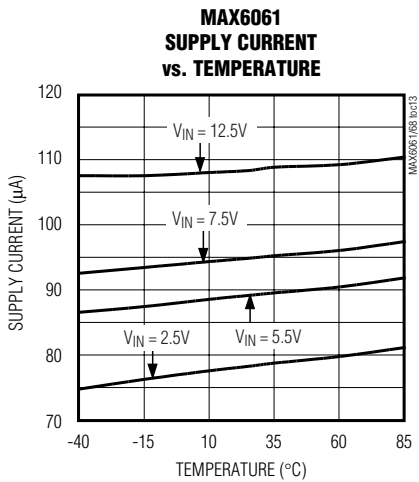
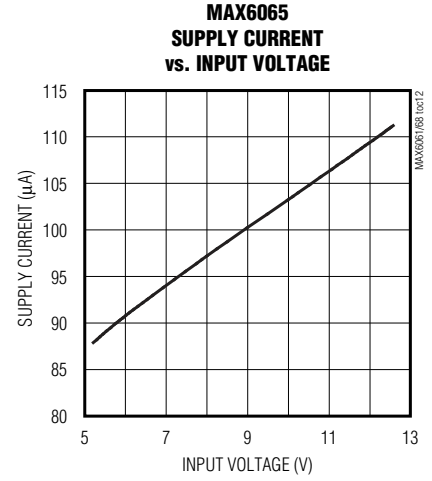
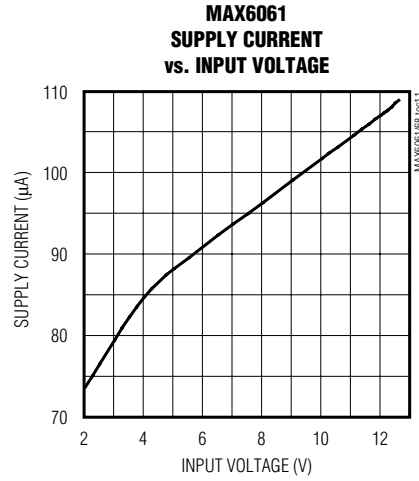
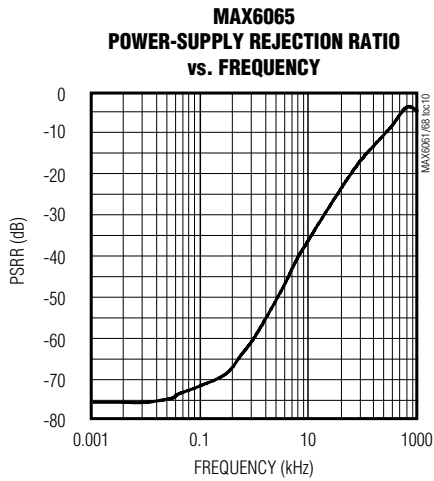

# Precision, Micropower, Low-Dropout, High-Output-Current, SOT23 Voltage References

## Typical Operating Characteristics (continued)

( $V_{IN} = +5V$  for MAX6061-MAX6068,  $V_{IN} = +5.5V$  for MAX6065,  $I_{OUT} = 0$ ,  $T_A = +25^\circ C$ , unless otherwise noted.) (Note 5)

**MAX6061  
TURN-ON TRANSIENT  
( $C_L = 50pF$ )**

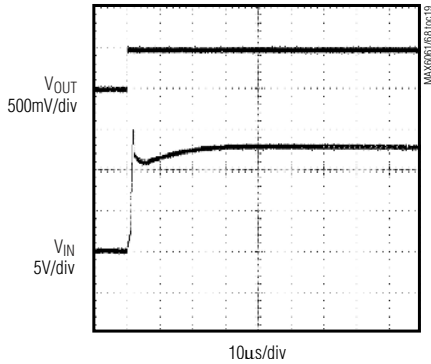

**MAX6065  
TURN-ON TRANSIENT  
( $C_L = 50pF$ )**

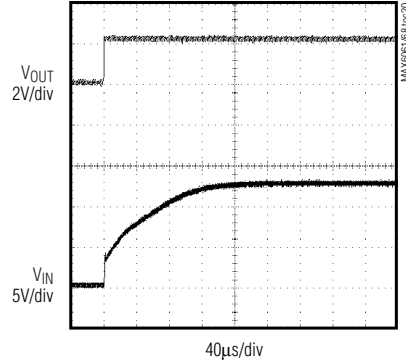

**MAX6061  
LOAD TRANSIENT  
( $I_{OUT} = \pm 250\mu A$ ,  $V_{IN} = 5.0$ ,  $C_L = 0$ )**

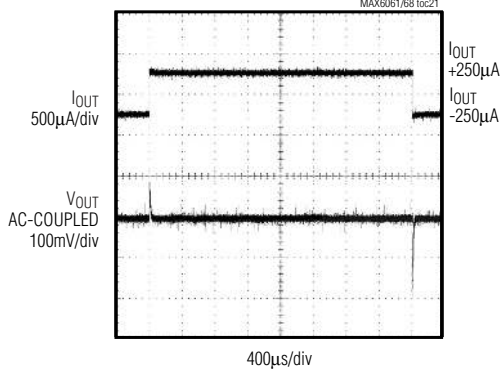

**MAX6065  
LOAD TRANSIENT  
( $I_{OUT} = \pm 250\mu A$ ,  $C_L = 0$ ,  $V_{IN} = 5.5V$ )**

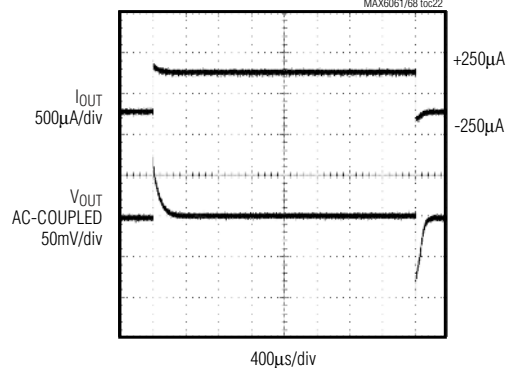

**MAX6061  
LOAD TRANSIENT  
( $I_{OUT} = \pm 250\mu A$ ,  $V_{IN} = 5.0V$ ,  $C_L = 1\mu F$ )**

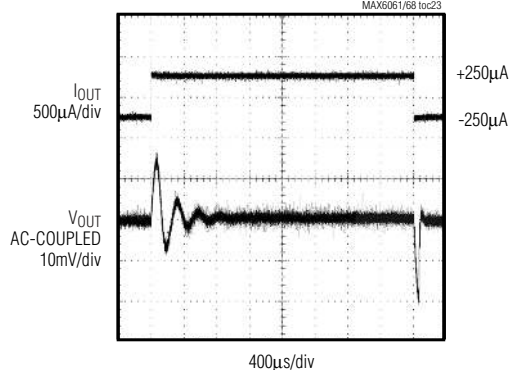

**MAX6065  
LOAD TRANSIENT  
( $I_{OUT} = \pm 250\mu A$ ,  $C_L = 1\mu F$ ,  $V_{IN} = 5.5V$ )**

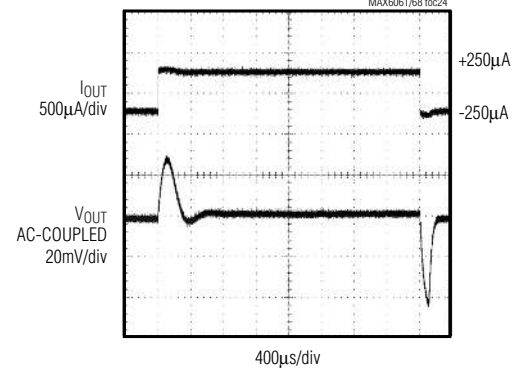

# Precision, Micropower, Low-Dropout, High-Output-Current, SOT23 Voltage References

## Typical Operating Characteristics (continued)

( $V_{IN} = +5V$  for MAX6061–MAX6068,  $V_{IN} = +5.5V$  for MAX6065,  $I_{OUT} = 0$ ,  $T_A = +25^\circ C$ , unless otherwise noted.) (Note 5)

MAX6061–MAX6068

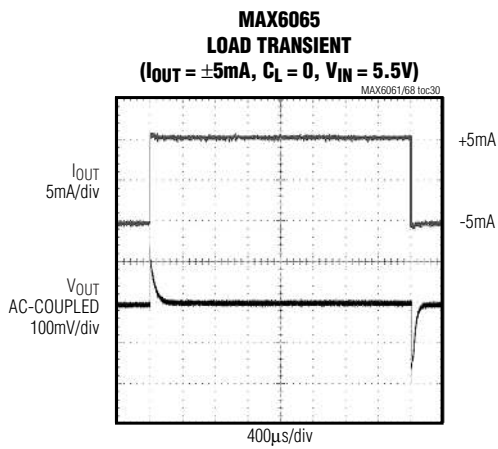
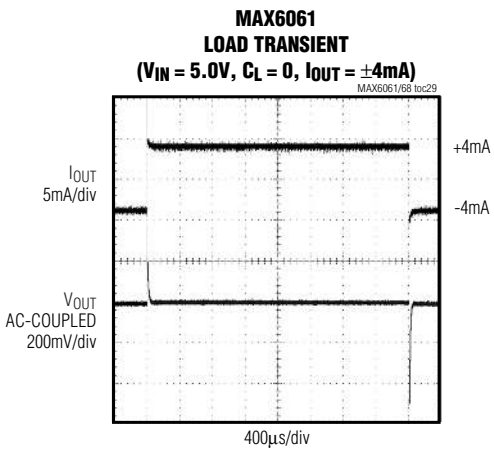
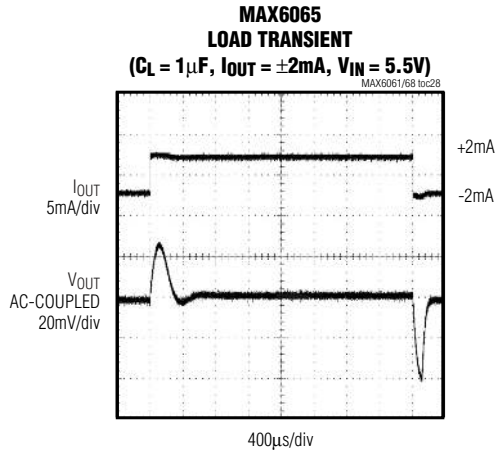
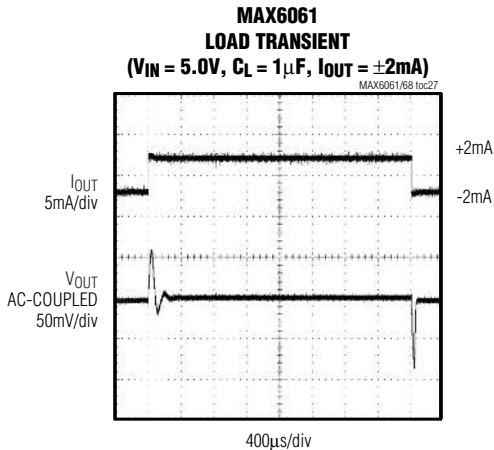
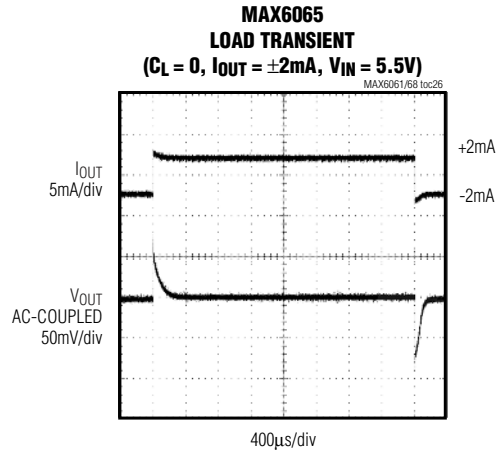
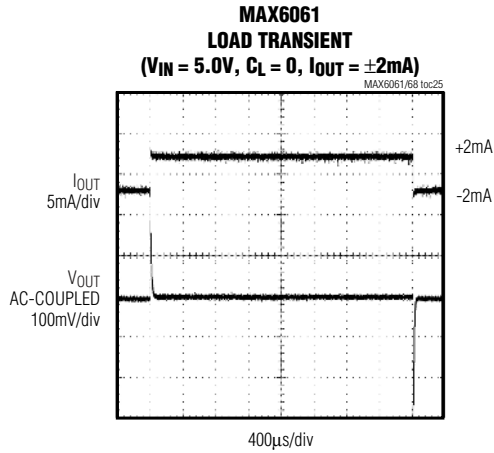

# Precision, Micropower, Low-Dropout, High-Output-Current, SOT23 Voltage References

## Typical Operating Characteristics (continued)

( $V_{IN} = +5V$  for MAX6061-MAX6068,  $V_{IN} = +5.5V$  for MAX6065,  $I_{OUT} = 0$ ,  $T_A = +25^\circ C$ , unless otherwise noted.) (Note 5)

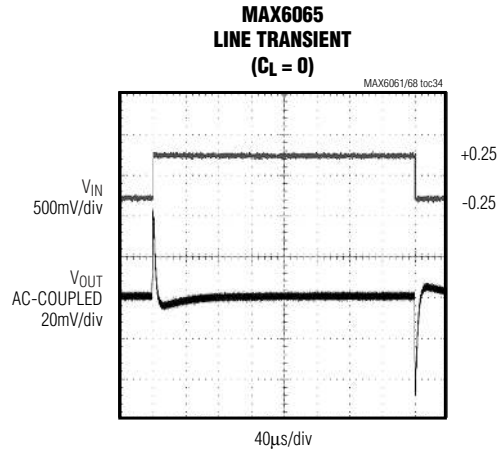
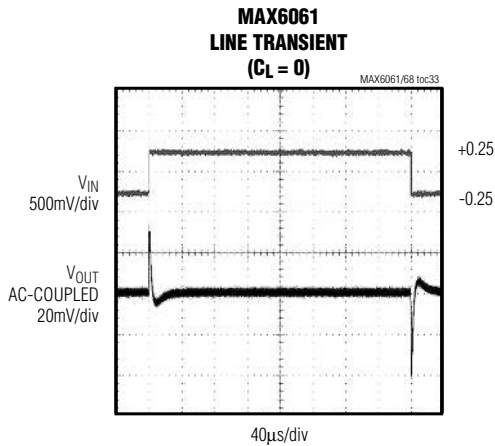
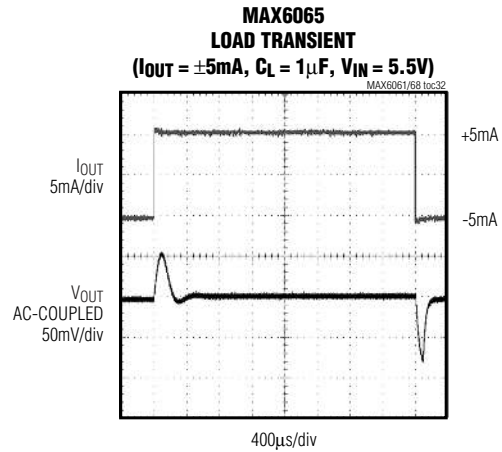
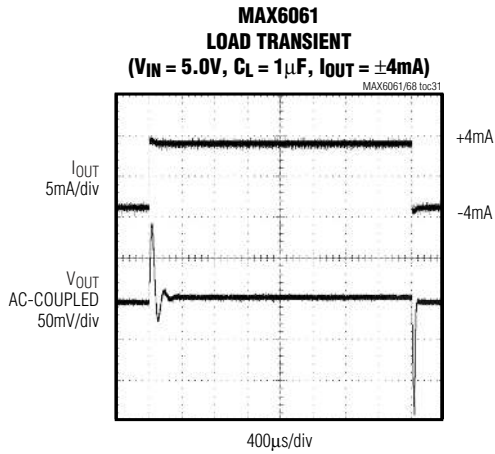

**Note 5:** Many of the MAX6061 family *Typical Operating Characteristics* are extremely similar. The extremes of these characteristics are found in the MAX6061 (1.25V output) and the MAX6065 (5.0V output). The *Typical Operating Characteristics* of the remainder of the MAX6061 family, typically lie between these two extremes and can be estimated based on their output voltages.

# Precision, Micropower, Low-Dropout, High-Output-Current, SOT23 Voltage References

MAX6061-MAX6068

## Pin Description

PIN	NAME	FUNCTION
1	IN	Input Voltage
2	OUT	Reference Output
3	GND	Ground

## Applications Information

### Input Bypassing

For the best line-transient performance, decouple the input with a 0.1 $\mu$ F ceramic capacitor as shown in the *Typical Operating Circuit*. Locate the capacitor as close to IN as possible. Where transient performance is less important, no capacitor is necessary.

### Output/Load Capacitance

Devices in the MAX6061 family do not require an output capacitance for frequency stability. In applications where the load or the supply can experience step changes, an output capacitor of at least 0.1 $\mu$ F will reduce the amount of overshoot (undershoot) and improve the circuit's transient response. Many applications do not require an external capacitor, and the MAX6061 family can offer a significant advantage in these applications when board space is critical.

### Supply Current

The quiescent supply current of the series-mode MAX6061 family is typically 90 $\mu$ A and is virtually independent of the supply voltage, with only an 8 $\mu$ A/V (max) variation with supply voltage. Unlike series references, shunt-mode references operate with a series resistor connected to the power supply. The quiescent current of a shunt-mode reference is thus a function of the input voltage. Additionally, shunt-mode references have to be biased at the maximum expected load current, even if the load current is not present at the time. In the MAX6061 family, the load current is drawn from the input voltage only when required, so supply current is not wasted and efficiency is maximized at all input voltages. This improved efficiency reduces power dissipation and extends battery life. When the supply voltage is below the minimum specified input voltage (as during turn-on), the devices can draw up to 400 $\mu$ A beyond the nominal supply current. The input voltage source must be capable of providing this current to ensure reliable turn-on.

## Typical Operating Circuit

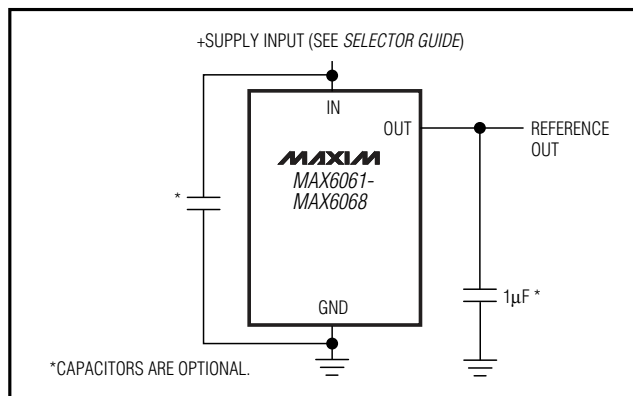

## Ordering Information (continued)

PART	TEMP. RANGE	PIN-PACKAGE	TOP MARK
MAX6067AEUR-T	-40°C to +85°C	3 SOT23-3	FZFS
MAX6067BEUR-T	-40°C to +85°C	3 SOT23-3	FZFT
MAX6068AEUR-T	-40°C to +85°C	3 SOT23-3	FZIB
MAX6068BEUR-T	-40°C to +85°C	3 SOT23-3	FZIC

### Output Voltage Hysteresis

Output voltage hysteresis is the change of output voltage at  $T_A = +25^\circ\text{C}$  before and after the device is cycled over its entire operating temperature range. Hysteresis is caused by differential package stress appearing across the bandgap core transistors. The typical temperature hysteresis value is 130ppm.

### Turn-On Time

These devices typically turn on and settle to within 0.1% of their final value in 50 $\mu$ s to 300 $\mu$ s, depending on the device. The turn-on time can increase up to 1.5ms with the device operating at the minimum dropout voltage and the maximum load.

## Chip Information

TRANSISTOR COUNT: 117

PROCESS: BiCMOS

# Precision, Micropower, Low-Dropout, High-Output-Current, SOT23 Voltage References

## Package Information

NOTES:

1. D&E DO NOT INCLUDE MOLD FLASH.
2. MOLD FLASH OR PROTRUSIONS NOT TO EXCEED .15mm (.006")
3. CONTROLLING DIMENSION: MILLIMETER

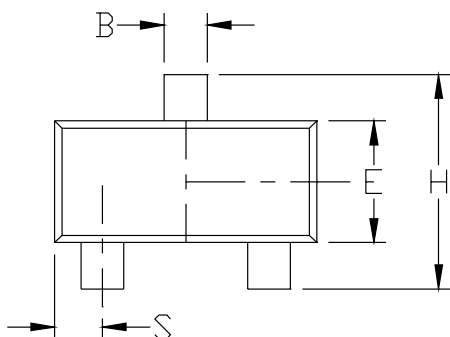

DIM	INCHES		MILLIMETERS	
	MIN	MAX	MIN	MAX
A	0.031	0.047	0.787	1.194
A1	0.001	0.005	0.025	0.127
B	0.014	0.022	0.356	0.559
C	0.0034	0.006	0.086	0.152
D	0.105	0.120	2.667	3.048
E	0.047	0.055	1.194	1.397
e	0.070	0.080	1.778	2.032
H	0.082	0.098	2.083	2.489
L	0.004	0.012	0.102	0.305
S	0.017	0.022	0.432	0.559
$\alpha$	0°	8°	0°	8°

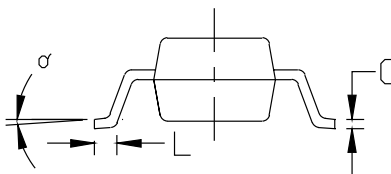
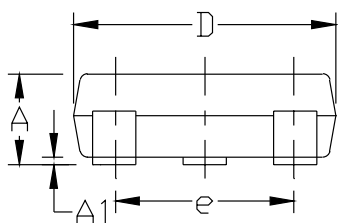

<b>MAXIM</b>			
<small>PROPRIETARY INFORMATION</small>			
<small>TITLE:</small>			
PACKAGE OUTLINE, SOT-23, 3L			
<small>APPROVAL</small>	<small>DOCUMENT CONTROL NO.</small>	<small>REV</small>	<small>1/1</small>
	21-0051	C	

SOT23LEFS

Maxim cannot assume responsibility for use of any circuitry other than circuitry entirely embodied in a Maxim product. No circuit patent licenses are implied. Maxim reserves the right to change the circuitry and specifications without notice at any time.

16 **Maxim Integrated Products, 120 San Gabriel Drive, Sunnyvale, CA 94086 408-737-7600**