

EVALUATION KIT
AVAILABLE

Dual-Phase, Quick-PWM Controllers for IMVP-6+/IMVP-6.5 CPU Core Power Supplies

General Description

The MAX17021/MAX17082/MAX17482 are 2/1-phase-interleaved Quick-PWM™ step-down VID power-supply controllers for notebook CPUs. True out-of-phase operation reduces input ripple current requirements and output-voltage ripple, while easing component selection and layout difficulties. The Quick-PWM control provides instantaneous response to fast load-current steps. Active voltage positioning reduces power dissipation and bulk output capacitance requirements and allows ideal positioning compensation for tantalum, polymer, or ceramic bulk output capacitors.

A slew-rate controller allows controlled transitions between VID codes, controlled soft-start and shutdown, and controlled exit from suspend. A thermistor-based temperature sensor provides a programmable thermal-fault output (VRHOT). A current monitor output (IMON) provides an analog current output proportional to the power consumed by the CPU (MAX17082/MAX17482 only). Output under-voltage, overvoltage (MAX17021/MAX17082 only), and thermal protection shut the controller down when any of these faults are detected. A voltage-regulator power-OK (PWRGD) output indicates the output is in regulation. Additionally, the MAX17021/MAX17082/MAX17482 feature true differential current sense and a phase-good (PHASEGD) output that indicates a phase imbalance fault condition.

The MAX17021 supports the IMVP-6+ specification while the MAX17082/MAX17482 support the IMVP-6.5 requirements. The MAX17021/MAX17082/MAX17482 are available in a 5mm x 5mm, 40-pin TQFN package.

Applications

IMVP-6+/IMVP-6.5 Core Supply
Multiphase CPU Core Supply
Voltage-Positioned, Step-Down Converters
Notebook/Desktop Computers
Blade Servers

Ordering Information

PART	TEMP RANGE	PIN-PACKAGE
MAX17021GTL+	-40°C to +105°C	40 TQFN-EP*
MAX17082GTL+	-40°C to +105°C	40 TQFN-EP*
MAX17482GTL+	-40°C to +105°C	40 TQFN-EP*

+Denotes a lead-free (Pb)/RoHS-compliant package.

*EP = Exposed pad.

Quick-PWM is a trademark of Maxim Integrated Products, Inc.

Features

- ◆ Single-/Dual-Phase, Quick-PWM Controllers
- ◆ MAX17021 IMVP-6+ (Montevina)
- ◆ MAX17082/MAX17482 IMVP-6.5 (Calpella)
- ◆ $\pm 0.5\%$ V_{OUT} Accuracy Over Line, Load, and Temperature
- ◆ 7-Bit 0 to 1.50V VID Control
- ◆ Dynamic Phase Selection Optimizes Active/Sleep Efficiency
- ◆ Transient Phase Overlap Reduces Output Capacitance
- ◆ Integrated Boost Switches
- ◆ Active Voltage Positioning with Adjustable Gain
- ◆ Programmable 200kHz to 800kHz Switching Frequency
- ◆ Accurate Current Balance and Current Limit
- ◆ Adjustable Slew-Rate Control
- ◆ Power-Good, Clock Enable, and Thermal-Fault Outputs
- ◆ Phase Current Imbalance Fault Output
- ◆ Drives Large Synchronous Rectifier MOSFETs
- ◆ 4V to 26V Battery Input-Voltage Range
- ◆ Undervoltage and Thermal-Fault Protection
- ◆ Overvoltage Protection (MAX17021/MAX17082)
- ◆ Soft-Startup and Soft-Shutdown

Pin Configuration

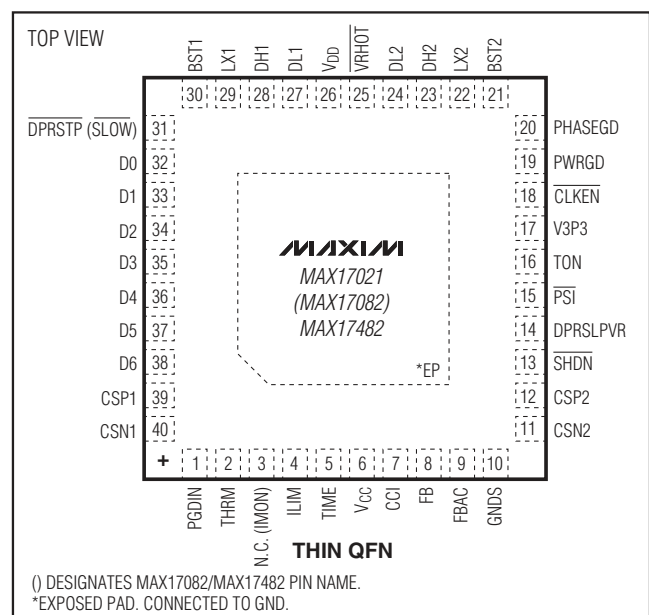

MAX17021/MAX17082/MAX17482



Dual-Phase, Quick-PWM Controllers for IMVP-6+/IMVP-6.5 CPU Core Power Supplies

ABSOLUTE MAXIMUM RATINGS

V _{CC} , V _{DD} , V3P3 to GND	-0.3V to +6V
D0–D6 to GND	-0.3V to +6V
PGDIN, DPRSLPVR, \overline{PSI} to GND	-0.3V to +6V
DPRSTP (MAX17021) to GND	-0.3V to +6V
SLOW (MAX17082/MAX17482) to GND	-0.3V to +6V
CSP1, CSP2, CSN1, CSN2 to GND	-0.3V to +6V
THRM, ILIM, PHASEGD to GND	-0.3V to +6V
PWRGD, \overline{VRHOT} to GND	-0.3V to +6V
CLKEN to GND	-0.3V to V3P3 + 0.3V
FB, FBAC to GND	-0.3V to V _{CC} + 0.3V
TIME, CCI to GND	-0.3V to V _{CC} + 0.3V
IMON to GND (MAX17021/MAX17082)	-0.3V to V _{CC} + 0.3V
GNDS to GND	-0.3V to +0.3V
SHDN to GND (Note 1)	-0.3V to +16V
TON to GND	-0.3V to +30V

DL1, DL2 to GND	-0.3V to V _{DD} + 0.3V
BST1, BST2 to GND	-0.3V to +36V
BST1, BST2 to V _{DD}	-0.3V to +30V
LX1 to BST1	-6V to +0.3V
LX2 to BST2	-6V to +0.3V
DH1 to LX1	(-0.3V to V _{BST1}) + 0.3V
DH2 to LX2	(-0.3V to V _{BST2}) + 0.3V
Continuous Power Dissipation	
40-Pin 5mm x 5mm TQFN Up to +70°C	1778mW
(derate above +70°C)	22.2mW/°C
Operating Temperature Range	-40°C to +105°C
Junction Temperature	+150°C
Storage Temperature Range	-65°C to +165°C
Lead Temperature (soldering, 10s)	+300°C

Note 1: \overline{SHDN} might be forced to 12V for the purpose of debugging prototype boards using the no-fault test mode, which disables fault protection and overlapping operation.

Stresses beyond those listed under “Absolute Maximum Ratings” may cause permanent damage to the device. These are stress ratings only, and functional operation of the device at these or any other conditions beyond those indicated in the operational sections of the specifications is not implied. Exposure to absolute maximum rating conditions for extended periods may affect device reliability.

ELECTRICAL CHARACTERISTICS

(Circuit of Figure 1, V_{IN} = 10V, V_{CC} = V_{DD} = V \overline{SHDN} = V_{PGDIN} = V \overline{PSI} = V_{ILIM} = 5V, V3P3 = 3.3V, DPRSLPVR = GNDS = GND, V_{CSP1} = V_{CSN1} = V_{CSP2} = V_{CSN2} = 1.0000V, FB = FBAC, R_{FBAC} = 3.57k Ω from FBAC to CSN1, D6–D0 = [0101000]; MAX17082/MAX17482: V \overline{SLOW} = 5V; MAX17021: DPRSTP = GND; T_A = 0°C to +85°C, unless otherwise noted. Typical values are at T_A = +25°C.)

PARAMETER	SYMBOL	CONDITIONS		MIN	TYP	MAX	UNITS	
PWM CONTROLLER								
Input-Voltage Range		V _{CC} , V _{DD}		4.5		5.5	V	
		V3P3		3.0		3.6		
DC Output-Voltage Accuracy	V _{OUT}	Measured at FB with respect to GNDS; includes load-regulation error (Note 2)	DAC codes from 0.8125V to 1.5000V	-0.5		+0.5	%	
			DAC codes from 0.3750V to 0.8000V	-7		+7		mV
			DAC codes from 0 to 0.3625V	-20		+20		
Boot Voltage	V _{BOOT}	MAX17021 IMVP-6+		1.194	1.200	1.206	V	
		MAX17082/MAX17482 IMVP-6.5		1.094	1.100	1.106		
Line Regulation Error		V _{CC} = 4.5V to 5.5V, V _{IN} = 4.5V to 26V			0.1		%	
FB Input Bias Current		T _A = +25°C		-0.1		+0.1	μ A	
GNDS Input Range				-200		+200	mV	
GNDS Gain	A _{GNDS}	$\Delta V_{OUT}/\Delta V_{GNDS}$		0.97	1.00	1.03	V/V	
GNDS Input Bias Current	I _{GNDS}	T _A = +25°C		-0.5		+0.5	μ A	
TIME Regulation Voltage	V _{TIME}	R _{TIME} = 71.5k Ω		1.985	2.000	2.015	V	

Dual-Phase, Quick-PWM Controllers for IMVP-6+/IMVP-6.5 CPU Core Power Supplies

MAX17021/MAX17082/MAX17482

ELECTRICAL CHARACTERISTICS (continued)

(Circuit of Figure 1, $V_{IN} = 10V$, $V_{CC} = V_{DD} = \overline{V_{SHDN}} = V_{PGDIN} = V_{PSI} = V_{LIM} = 5V$, $V_{3P3} = 3.3V$, $DPRSLPVR = GNDS = GND$, $V_{CSP1} = V_{CSN1} = V_{CSP2} = V_{CSN2} = 1.0000V$, $FB = FBAC$, $R_{FBAC} = 3.57k\Omega$ from FBAC to CSN1, $D6-D0 = [0101000]$; MAX17082/MAX17482: $\overline{V_{SLOW}} = 5V$; MAX17021: $\overline{DPRSTP} = GND$; $T_A = 0^\circ C$ to $+85^\circ C$, unless otherwise noted. Typical values are at $T_A = +25^\circ C$.)

PARAMETER	SYMBOL	CONDITIONS	MIN	TYP	MAX	UNITS	
TIME Slew-Rate Accuracy		$R_{TIME} = 71.5k\Omega$ (12.5mV/ μs nominal)	-10		+10	%	
		$R_{TIME} = 35.7k\Omega$ (25mV/ μs nominal) to 178k Ω (5mV/ μs nominal)	-15		+15		
		Soft-start and soft-shutdown: $R_{TIME} = 35.7k\Omega$ (3.125mV/ μs nominal) to 178k Ω (0.625mV/ μs nominal)	-25		+25		
		Slow: IMVP-6.5 (MAX17082/MAX17482): $\overline{V_{SLOW}} = 0V$, 1/2 of nominal slew rate, $R_{TIME} = 71.5k\Omega$ (6.25mV/ μs nominal); IMVP-6+ (MAX17021): $\overline{V_{DPRSTP}} = V_{DPRSLPVR} = 5V$, 1/4 of nominal slew rate, $R_{TIME} = 71.5k\Omega$ (3.125mV/ μs nominal)	-15		+15		
		Slow: IMVP-6.5 (MAX17082/MAX17482): $\overline{V_{SLOW}} = 0V$, 1/2 of nominal slew rate, $R_{TIME} = 35.7k\Omega$ (12.5mV/ μs nominal) to 178k Ω (2.5mV/ μs nominal); IMVP-6+ (MAX17021): $\overline{V_{DPRSTP}} = V_{DPRSLPVR} = 5V$ 1/4 of nominal slew rate, $R_{TIME} = 35.7k\Omega$ (6.25mV/ μs nominal) to 178k Ω (1.25mV/ μs nominal)	-15		+15		
On-Time	t_{ON}	Measured at DH_- (Note 3)	$R_{TON} = 96.75k\Omega$ (600kHz per phase), 167ns nominal	-15		+15	%
			$R_{TON} = 200k\Omega$ (300kHz per phase), 333ns nominal	-10		+10	
			$R_{TON} = 303.25k\Omega$ (200kHz per phase), 500ns nominal	-15		+15	
Minimum Off-Time	$t_{OFF(MIN)}$	Measured at DH_- (Note 3)		300	350	ns	
TON Shutdown Input Current	$I_{RTON,SDN}$	$\overline{SHDN} = GND$, $V_{IN} = 26V$, $V_{CC} = V_{DD} = 0V$ or 5V, $T_A = +25^\circ C$		0.01	0.1	μA	
BIAS CURRENTS							
Quiescent Supply Current (V_{CC})	I_{CC}	Measured at V_{CC} , $V_{DPRSLPVR} = 5V$, FB forced above the regulation point		2.5	5	mA	
Quiescent Supply Current (V_{DD})	I_{DD}	Measured at V_{DD} , $V_{DPRSLPVR} = 0V$, FB forced above the regulation point, $T_A = +25^\circ C$		0.02	1	μA	

Dual-Phase, Quick-PWM Controllers for IMVP-6+/IMVP-6.5 CPU Core Power Supplies

ELECTRICAL CHARACTERISTICS (continued)

(Circuit of Figure 1, $V_{IN} = 10V$, $V_{CC} = V_{DD} = V_{SHDN} = V_{PGDIN} = V_{PSI} = V_{LIM} = 5V$, $V_{3P3} = 3.3V$, $DPRSLPVR = GNDS = GND$, $V_{CSP1} = V_{CSN1} = V_{CSP2} = V_{CSN2} = 1.0000V$, $FB = FBAC$, $R_{FBAC} = 3.57k\Omega$ from $FBAC$ to $CSN1$, $D6-D0 = [0101000]$; MAX17082/MAX17482: $V_{SLOW} = 5V$; MAX17021: $\overline{DPRSTP} = GND$; $T_A = 0^\circ C$ to $+85^\circ C$, unless otherwise noted. Typical values are at $T_A = +25^\circ C$.)

PARAMETER	SYMBOL	CONDITIONS	MIN	TYP	MAX	UNITS	
Quiescent Supply Current (V3P3)	I_{3P3}	Measured at V3P3, FB forced within the \overline{CLKEN} power-good window		2	4	μA	
Shutdown Supply Current (V_{CC})	$I_{CC,SDN}$	Measured at V_{CC} , $\overline{SHDN} = GND$, $T_A = +25^\circ C$		0.01	1	μA	
Shutdown Supply Current (V_{DD})	$I_{DD,SDN}$	Measured at V_{DD} , $\overline{SHDN} = GND$, $T_A = +25^\circ C$		0.01	1	μA	
Shutdown Supply Current (V3P3)	$I_{3P3,SDN}$	Measured at V3P3, $\overline{SHDN} = GND$, $T_A = +25^\circ C$		0.01	1	μA	
FAULT PROTECTION							
Output Overvoltage-Protection Threshold (MAX17021/MAX17082 Only)	VOVP	Skip mode after output reaches the regulation voltage or PWM mode; measured at FB with respect to the voltage target set by the VID code; see Table 4.	250	300	350	mV	
		Soft-start, soft-shutdown, skip mode, and output have not reached the regulation voltage; measured at FB	IMVP-6.5 (MAX17082)	1.45	1.50	1.55	V
			IMVP-6+ (MAX17021)	1.75	1.80	1.85	
		Minimum OVP threshold; measured at FB	0.8				
Output Overvoltage-Propagation Delay (MAX17021/MAX17082 Only)	t_{OVP}	FB forced 25mV above trip threshold		10		μs	
Output Undervoltage-Protection Threshold	V_{UVP}	Measured at FB with respect to the voltage target set by the VID code; see Table 4	-450	-400	-350	mV	
Output Undervoltage-Propagation Delay	t_{UVP}	FB forced 25mV below trip threshold		10		μs	
\overline{CLKEN} Startup Delay and Boot Time Period	t_{BOOT}	Measured from the time when FB reaches the boot target voltage (Note 2)	20	60	100	μs	
PWRGD Startup Delay		Measured at startup from the time when \overline{CLKEN} goes low	3	6.5	10	ms	
\overline{CLKEN} and PWRGD Threshold		Measured at FB with respect to the voltage target set by the VID code; see Table 4, 20mV hysteresis (typ)	Lower threshold, falling edge (undervoltage)	-350	-300	-250	mV
			Upper threshold, rising edge (overvoltage)	+150	+200	+250	
\overline{CLKEN} and PWRGD Delay		FB forced 25mV outside the PWRGD trip thresholds		10		μs	
PHASEGD Delay		$V_{(CCI,FB)}$ forced 25mV outside trip thresholds		10		μs	

Dual-Phase, Quick-PWM Controllers for IMVP-6+/IMVP-6.5 CPU Core Power Supplies

MAX17021/MAX17082/MAX17482

ELECTRICAL CHARACTERISTICS (continued)

(Circuit of Figure 1, $V_{IN} = 10V$, $V_{CC} = V_{DD} = \overline{V_{SHDN}} = V_{PGDIN} = \overline{V_{PSI}} = V_{ILIM} = 5V$, $V_{3P3} = 3.3V$, $DPRSLPVR = GNDS = GND$, $V_{CSP1} = V_{CSN1} = V_{CSP2} = V_{CSN2} = 1.0000V$, $FB = FBAC$, $R_{FBAC} = 3.57k\Omega$ from FBAC to CSN1, $D6-D0 = [0101000]$; MAX17082/MAX17482: $\overline{V_{SLOW}} = 5V$; MAX17021: $\overline{DPRSTP} = GND$; $T_A = 0^\circ C$ to $+85^\circ C$, unless otherwise noted. Typical values are at $T_A = +25^\circ C$.)

PARAMETER	SYMBOL	CONDITIONS	MIN	TYP	MAX	UNITS	
CLKEN, PWRGD, and PHASEGD Transition Blanking Time (VID Transitions)	t_{BLANK}	Measured from the time when FB reaches the target voltage (Note 2)		20		μs	
PHASEGD Transition Blanking Time (Phase 2 Enable Transitions)		Number of DH2 pulses for which PHASEGD is blanked after phase 2 is enabled		32		Pulses	
\overline{CLKEN} Output Low Voltage		Low state, $I_{SINK} = 3mA$			0.4	V	
\overline{CLKEN} Output High Voltage		High state, $I_{SOURCE} = 3mA$	V3P3 - 0.4			V	
PWRGD, PHASEGD Output Low Voltage		Low state, $I_{SINK} = 3mA$			0.4	V	
PWRGD, PHASEGD Leakage Current		High-impedance state, PWRGD, PHASEGD forced to 5V, $T_A = +25^\circ C$			1	μA	
CSN1 Pulldown Resistance in Shutdown		$\overline{SHDN} = 0$, measured after soft-shutdown completed ($DL_- = low$)		10		Ω	
VCC Undervoltage Lockout (UVLO) Threshold	$V_{UVLO(VCC)}$	Rising edge, 65mV typical hysteresis, controller disabled below this level	4.05	4.27	4.48	V	
THERMAL PROTECTION							
\overline{VRHOT} Trip Threshold		Measured at THRM as a percentage of VCC, falling edge, typical hysteresis = 75mV	29	30	31	%	
\overline{VRHOT} Delay	$t_{\overline{VRHOT}}$	THRM forced 25mV below the \overline{VRHOT} trip threshold, falling edge		10		μs	
\overline{VRHOT} Output On-Resistance	$R_{ON(\overline{VRHOT})}$	Low state		2	10	Ω	
\overline{VRHOT} Leakage Current		High-impedance state, \overline{VRHOT} forced to 5V, $T_A = +25^\circ C$			1	μA	
THRM Input Leakage	I_{THRM}	$V_{THRM} = 0$ to 5V, $T_A = +25^\circ C$	-0.1		+0.1	μA	
Thermal-Shutdown Threshold	T_{SHDN}	Typical hysteresis = 15°C		160		°C	
VALLEY CURRENT LIMIT, DROOP, AND CURRENT BALANCE							
Current-Limit Threshold Voltage (Positive)	V_{LIMIT}	$V_{CSP_} - V_{CSN_}$	$V_{TIME} - V_{ILIM} = 100mV$	7	10	13	mV
			$V_{TIME} - V_{ILIM} = 500mV$	45	50	55	
			$ILIM = V_{CC}$	20	22.5	25	
Current-Limit Threshold Voltage (Negative) Accuracy	$V_{LIMIT(NEG)}$	$V_{CSP_} - V_{CSN_}$, nominally -125% of V_{LIMIT}	-4		+4	mV	
Current-Limit Threshold Voltage (Zero Crossing)	V_{ZERO}	$V_{GND} - V_{LX_}$, $DPRSLPVR = 5V$		1		mV	

Dual-Phase, Quick-PWM Controllers for IMVP-6+/IMVP-6.5 CPU Core Power Supplies

ELECTRICAL CHARACTERISTICS (continued)

(Circuit of Figure 1, $V_{IN} = 10V$, $V_{CC} = V_{DD} = V_{SHDN} = V_{PGDIN} = V_{PSI} = V_{LIM} = 5V$, $V_{3P3} = 3.3V$, $DPRSLPVR = GNDS = GND$, $V_{CSP1} = V_{CSN1} = V_{CSP2} = V_{CSN2} = 1.0000V$, $FB = FBAC$, $R_{FBAC} = 3.57k\Omega$ from $FBAC$ to $CSN1$, $D6-D0 = [0101000]$; MAX17082/MAX17482: $V_{SLOW} = 5V$; MAX17021: $\overline{DPRSTP} = GND$; $T_A = 0^\circ C$ to $+85^\circ C$, unless otherwise noted. Typical values are at $T_A = +25^\circ C$.)

PARAMETER	SYMBOL	CONDITIONS	MIN	TYP	MAX	UNITS	
CSP_, CSN_ Common-Mode Input Range			0		2	V	
Phase 2 Disable Threshold		Measured at CSP2	3	$V_{CC} - 1$	$V_{CC} - 0.4$	V	
CSP_, CSN_ Input Current	$I_{CSP_}$, $I_{CSN_}$	$T_A = +25^\circ C$	-0.2		+0.2	μA	
ILIM Input Current	I_{LIM}	$T_A = +25^\circ C$	-0.1		+0.1	μA	
Droop Amplifier Offset		$(1/N) \times \sum (V_{CSP_} - V_{CSN_})$ at $I_{FBAC} = 0$; \sum indicates summation over all phases from 1 to N, $N = 2$	$T_A = +25^\circ C$	-0.5		+0.5	mV/phase
			$T_A = 0^\circ C$ to $+85^\circ C$	-0.75		+0.75	
Droop Amplifier Transconductance	$G_m(FBAC)$	$\Delta I_{FBAC} / \Delta [\sum (V_{CSP_} - V_{CSN_})]$; \sum indicates summation over all phases from 1 to N, $N = 2$, $V_{FBAC} = V_{CSN-} = 0.45V$ to $2V$	590	600	608	μS	
Current-Balance Amplifier Offset		$(V_{CSP1} - V_{CSN1}) - (V_{CSP2} - V_{CSN2})$ at $I_{CCI} = 0$	-1.0		+1.0	mV	
Current-Balance Amplifier Transconductance	$G_m(CCI)$	$I_{CCI} / [(V_{CSP1} - V_{CSN1}) - (V_{CSP2} - V_{CSN2})]$		200		μS	
CURRENT MONITOR (MAX17082/MAX17482 Only)							
Current-Monitor Output Current at Full Load Condition	I_{IMON}	$V_{CSP1} - V_{CSN1} = V_{CSP2} - V_{CSN2} = 20mV$, $V_{CSN-} = 0.45V$ to $2.0V$	93.12	96	98.88	μA	
Current-Monitor Transconductance	$G_m(IMON)$	$\Delta I_{IMON} / \Delta [\sum (V_{CSP_} - V_{CSN_})]$; \sum indicates summation over all phases from 1 to N, $N = 2$, $CSN- = 0.45V$ to $2V$	2.2	2.4	2.6	mS	
IMON Clamp Voltage	$V_{IMON,max}$	$I_{SINK} = 10mA$	1.05	1.10	1.15	V	
IMON Pulldown Resistance in Shutdown		$\overline{SHDN} = 0$, measured after soft-shutdown completed ($DL_- = low$)		10		Ω	
GATE DRIVERS							
DH_ Gate Driver On-Resistance	$R_{ON(DH_)}$	BST_ - LX_ forced to 5V	High state (pullup)	0.9	2.5	Ω	
			Low state (pulldown)	0.7	2.0		
DL_ Gate Driver On-Resistance	$R_{ON(DL_)}$		High state (pullup)	0.7	2.0	Ω	
			Low state (pulldown)	0.25	0.7		
DH_ Gate Driver Source Current	$I_{DH_(SOURCE)}$	DH_ forced to 2.5V, BST_ - LX_ forced to 5V		2.2		A	
DH_ Gate Driver Sink Current	$I_{DH_(SINK)}$	DH_ forced to 2.5V, BST_ - LX_ forced to 5V		2.7		A	
DL_ Gate Driver Source Current	$I_{DL_(SOURCE)}$	DL_ forced to 2.5V		2.7		A	

Dual-Phase, Quick-PWM Controllers for IMVP-6+/IMVP-6.5 CPU Core Power Supplies

MAX17021/MAX17082/MAX17482

ELECTRICAL CHARACTERISTICS (continued)

(Circuit of Figure 1, $V_{IN} = 10V$, $V_{CC} = V_{DD} = V_{SHDN} = V_{PGDIN} = V_{PSI} = V_{LIM} = 5V$, $V_{3P3} = 3.3V$, $DPRSLPVR = GNDS = GND$, $V_{CSP1} = V_{CSN1} = V_{CSP2} = V_{CSN2} = 1.0000V$, $FB = FBAC$, $R_{FBAC} = 3.57k\Omega$ from FBAC to CSN1, $D6-D0 = [0101000]$; MAX17082/MAX17482: $V_{SLOW} = 5V$; MAX17021: $\overline{DPRSTP} = GND$; $T_A = 0^\circ C$ to $+85^\circ C$, unless otherwise noted. Typical values are at $T_A = +25^\circ C$.)

PARAMETER	SYMBOL	CONDITIONS	MIN	TYP	MAX	UNITS
DL_ Gate Driver Sink Current	$I_{DL(SINK)}$	DL_ forced to 2.5V		8		A
Internal BST_ Switch On-Resistance	$R_{ON(BST_)}$			10	20	Ω
LOGIC AND I/O						
Logic Input High Voltage	V_{IH}	\overline{SHDN} , PGDIN MAX17021: DPRSLPVR	2.3			V
Logic Input Low Voltage	V_{IL}	\overline{SHDN} , PGDIN MAX17021: DPRSLPVR			1.0	V
\overline{SHDN} No-Fault Level		To enable no-fault mode	11		13	V
Low-Voltage Logic Input High Voltage	V_{IHLV}	\overline{PSI} , D0-D6; MAX17082/MAX17482: DPRSLPVR, \overline{SLOW} , MAX17021: \overline{DPRSTP}	0.67			V
Low-Voltage Logic Input Low Voltage	V_{ILLV}	\overline{PSI} , D0-D6; MAX17082/MAX17482: DPRSLPVR, \overline{SLOW} , MAX17021: \overline{DPRSTP}			0.33	V
Logic Input Current		$T_A = +25^\circ C$, \overline{SHDN} , DPRSLPVR, PGDIN, \overline{PSI} , \overline{DPRSTP} , \overline{SLOW} , D0-D6 = 0 or 5V	-1		+1	μA

ELECTRICAL CHARACTERISTICS

(Circuit of Figure 1, $V_{IN} = 10V$, $V_{CC} = V_{DD} = V_{SHDN} = V_{PGDIN} = V_{PSI} = V_{LIM} = 5V$, $V_{3P3} = 3.3V$, $DPRSLPVR = GNDS = GND$, $V_{CSP1} = V_{CSN1} = V_{CSP2} = V_{CSN2} = 1.0000V$, $FB = FBAC$, $R_{FBAC} = 3.57k\Omega$ from FBAC to CSN1, $D6-D0 = [0101000]$; MAX17082/MAX17482: $V_{SLOW} = 5V$; MAX17021: $\overline{DPRSTP} = GND$; $T_A = -40^\circ C$ to $+105^\circ C$, unless otherwise noted.) (Note 4)

PARAMETER	SYMBOL	CONDITIONS	MIN	TYP	MAX	UNITS	
PWM CONTROLLER							
Input-Voltage Range		V_{CC} , V_{DD}	4.5		5.5	V	
		V_{3P3}	3.0		3.6		
DC Output-Voltage Accuracy	V_{OUT}	Measured at FB with respect to GNDS; includes load-regulation error (Note 2)	DAC codes from 0.8125V to 1.5000V	-0.75		+0.75	%
			DAC codes from 0.3750V to 0.8000V	-10		+10	mV
			DAC codes from 0 to 0.3625V	-25		+25	
Boot Voltage	V_{BOOT}	MAX17021: IMVP-6+	1.19		1.21	V	
		MAX17082/MAX17482: IMVP-6.5	1.09		1.11		

Dual-Phase, Quick-PWM Controllers for IMVP-6+/IMVP-6.5 CPU Core Power Supplies

ELECTRICAL CHARACTERISTICS (continued)

(Circuit of Figure 1, $V_{IN} = 10V$, $V_{CC} = V_{DD} = V_{SHDN} = V_{PGDIN} = V_{PSI} = V_{LIM} = 5V$, $V_{3P3} = 3.3V$, $DPRSLPVR = GND = GND$, $V_{CSP1} = V_{CSN1} = V_{CSP2} = V_{CSN2} = 1.0000V$, $FB = FBAC$, $R_{FBAC} = 3.57k\Omega$ from FBAC to CSN1, $D6-D0 = [0101000]$; MAX17082/MAX17482: $V_{SLOW} = 5V$; MAX17021: $\overline{DPRSTP} = GND$; $T_A = -40^{\circ}C$ to $+105^{\circ}C$, unless otherwise noted.) (Note 4)

PARAMETER	SYMBOL	CONDITIONS	MIN	TYP	MAX	UNITS	
GNDS Input Range			-200		+200	mV	
GNDS Gain	A_{GNDS}	$\Delta V_{OUT}/\Delta V_{GNDS}$	0.97		1.03	V/V	
TIME Regulation Voltage	V_{TIME}	$R_{TIME} = 71.5k\Omega$	1.985		2.015	V	
TIME Slew-Rate Accuracy		$R_{TIME} = 71.5k\Omega$ (12.5mV/ μ s nominal)	-10		+10	%	
		$R_{TIME} = 35.7k\Omega$ (25mV/ μ s nominal) to 178k Ω (5mV/ μ s nominal)	-15		+15		
		Soft-start and soft-shutdown: $R_{TIME} = 35.7k\Omega$ (3.125mV/ μ s nominal) to 178k Ω (0.625mV/ μ s nominal)	-25		+25		
		Slow: IMVP-6.5 (MAX17082/MAX17482): $V_{SLOW} = 0V$, 1/2 of nominal slew rate, $R_{TIME} = 71.5k\Omega$ (6.25mV/ μ s nominal); IMVP-6+ (MAX17021): $V_{DPRSTP} = V_{DPRSLPVR} = 5V$, 1/4 of nominal slew rate, $R_{TIME} = 71.5k\Omega$ (3.125mV/ μ s nominal)	-15		+15		
TIME Slew-Rate Accuracy		Slow: IMVP-6.5 (MAX17082/MAX17482): $V_{SLOW} = 0V$, 1/2 of nominal slew rate, $R_{TIME} = 35.7k\Omega$ (12.5mV/ μ s nominal) to 178k Ω (2.5mV/ μ s nominal); IMVP-6+ (MAX17021): $V_{DPRSTP} = V_{DPRSLPVR} = 5V$, 1/4 of nominal slew rate, $R_{TIME} = 35.7k\Omega$ (6.25mV/ μ s nominal) to 178k Ω (1.25mV/ μ s nominal)	-17		+17	%	
On-Time	t_{ON}	Measured at DH_ (Note 3)	$R_{TON} = 96.75k\Omega$ (600kHz per phase), 167ns nominal	-15		+15	%
			$R_{TON} = 200k\Omega$ (300kHz per phase), 333ns nominal	-15		+15	
			$R_{TON} = 303.25k\Omega$ (200kHz per phase), 500ns nominal	-15		+15	
Minimum Off-Time	$t_{OFF(MIN)}$	Measured at DH_ (Note 3)			350	ns	
BIAS CURRENTS							
Quiescent Supply Current (V_{CC})	I_{CC}	Measured at V_{CC} , $V_{DPRSLPVR} = 5V$, FB forced above the regulation point			5	mA	
Quiescent Supply Current (V_{3P3})	I_{3P3}	Measured at V_{3P3} , FB forced within the \overline{CLKEN} power-good window			4	μ A	

Dual-Phase, Quick-PWM Controllers for IMVP-6+/IMVP-6.5 CPU Core Power Supplies

ELECTRICAL CHARACTERISTICS (continued)

(Circuit of Figure 1, $V_{IN} = 10V$, $V_{CC} = V_{DD} = V_{SHDN} = V_{PGDIN} = V_{PSI} = V_{LIM} = 5V$, $V_{3P3} = 3.3V$, $DPRSLPVR = GNDS = GND$, $V_{CSP1} = V_{CSN1} = V_{CSP2} = V_{CSN2} = 1.0000V$, $FB = FBAC$, $R_{FBAC} = 3.57k\Omega$ from FBAC to CSN1, $D6-D0 = [0101000]$; MAX17082/MAX17482: $V_{SLOW} = 5V$; MAX17021: $\overline{DPRSTP} = GND$; $T_A = -40^\circ C$ to $+105^\circ C$, unless otherwise noted.) (Note 4)

PARAMETER	SYMBOL	CONDITIONS		MIN	TYP	MAX	UNITS
FAULT PROTECTION							
Output Overvoltage-Protection Threshold (MAX17021/MAX7082 Only)	V_{OVP}	Skip mode after output reaches the regulation voltage or PWM mode, measured at FB with respect to the voltage target set by the VID code (see Table 4)		250		350	mV
		Soft-start, soft-shutdown, skip mode, and output have not reached the regulation voltage, measured at FB	IMVP-6.5 (MAX17082)	1.45		1.55	V
			IMVP-6+ (MAX17021)	1.75		1.85	
Output Undervoltage-Protection Threshold	V_{UVP}	Measured at FB with respect to the voltage target set by the VID code (see Table 4)		-450		-350	mV
\overline{CLKEN} Startup Delay and Boot Time Period	t_{BOOT}	Measured from the time when FB reaches the boot target voltage (Note 3)		20		100	μs
PWRGD Startup Delay		Measured at startup from the time when \overline{CLKEN} goes low		3		10	ms
\overline{CLKEN} and PWRGD Threshold		Measured at FB with respect to the voltage target set by the VID code (see Table 4), 20mV hysteresis (typ)	Lower threshold, falling edge (undervoltage)	-350		-250	mV
			Upper threshold, rising edge (overvoltage)	+150		+250	
\overline{CLKEN} Output Low Voltage		Low state, $I_{SINK} = 3mA$				0.4	V
\overline{CLKEN} Output High Voltage		High state, $I_{SOURCE} = 3mA$		$V_{3P3} - 0.4$			V
PWRGD, PHASEGD Output Low Voltage		Low state, $I_{SINK} = 3mA$				0.4	V
V_{CC} Undervoltage-Lockout Threshold (UVLO)	$V_{UVLO(VCC)}$	Rising edge, 65mV typical hysteresis, controller disabled below this level		4.0		4.5	V
THERMAL PROTECTION							
\overline{VRHOT} Trip Threshold		Measured at THRM as a percentage of V_{CC} , falling edge, typical hysteresis = 75mV		28		32	%
\overline{VRHOT} Output On-Resistance	$R_{ON(\overline{VRHOT})}$	Low state				10	Ω

MAX17021/MAX17082/MAX17482

Dual-Phase, Quick-PWM Controllers for IMVP-6+/IMVP-6.5 CPU Core Power Supplies

ELECTRICAL CHARACTERISTICS (continued)

(Circuit of Figure 1, $V_{IN} = 10V$, $V_{CC} = V_{DD} = \overline{V_{SHDN}} = V_{PGDIN} = \overline{V_{PS1}} = V_{ILIM} = 5V$, $V_{3P3} = 3.3V$, $DPRSLPVR = GNDS = GND$, $V_{CSP1} = V_{CSN1} = V_{CSP2} = V_{CSN2} = 1.0000V$, $FB = FBAC$, $R_{FBAC} = 3.57k\Omega$ from FBAC to CSN1, $D6-D0 = [0101000]$; MAX17082/MAX17482: $\overline{V_{SLOW}} = 5V$; MAX17021: $\overline{DPRSTP} = GND$; $T_A = -40^\circ C$ to $+105^\circ C$, unless otherwise noted.) (Note 4)

PARAMETER	SYMBOL	CONDITIONS	MIN	TYP	MAX	UNITS
VALLEY CURRENT LIMIT, DROOP, AND CURRENT BALANCE						
Current-Limit Threshold Voltage (Positive)	V_{LIMIT}	$V_{CSP_} - V_{CSN_}$	$V_{TIME} - V_{ILIM} = 100mV$	7	13	mV
			$V_{TIME} - V_{ILIM} = 500mV$	40	60	
			$ILIM = V_{CC}$	19	26	
CSP_, CSN_ Common-Mode Input Range			0		2	V
Droop Amplifier Transconductance	$G_m(FBAC)$	$\Delta I_{FBAC}/\Delta[\sum(V_{CSP_} - V_{CSN_})]$, \sum indicates summation over all phases from 1 to N, $N = 2$, $V_{FBAC} = V_{CSN_} = 0.45V$ to $2V$	585		610	μS
Current-Balance Amplifier Offset		$(V_{CSP1} - V_{CSN1}) - (V_{CSP2} - V_{CSN2})$ at $I_{CCI} = 0$	-1.25		+1.25	mV
CURRENT MONITOR (MAX17082/MAX17482 Only)						
Current-Monitor Transconductance	$G_m(IMON)$	$\Delta I_{IMON}/\Delta[\sum(V_{CSP_} - V_{CSN_})]$, \sum indicates summation over all phases from 1 to N, $N = 2$, $V_{CSN_} = 0.45V$ to $2V$	2.2		2.6	mS
IMON Clamp Voltage	$V_{IMON,max}$	$I_{SINK} = 10mA$	1.05		1.15	V
GATE DRIVERS						
DH_ Gate Driver On-Resistance	$R_{ON(DH_)}$	BST_ - LX_ forced to 5V	High state (pullup)		2.5	Ω
			Low state (pulldown)		2.0	
DL_ Gate Driver On-Resistance	$R_{ON(DL_)}$		High state (pullup)		2.0	Ω
			Low state (pulldown)		0.7	
LOGIC AND I/O						
Logic Input High Voltage	V_{IH}	\overline{SHDN} , PGDIN: MAX17021: DPRSLPVR	2.3			V
Logic Input Low Voltage	V_{IL}	\overline{SHDN} , PGDIN: MAX17021: DPRSLPVR			1.0	V
Low-Voltage Logic Input High Voltage	V_{IHLV}	$\overline{PS1}$, D0-D6: MAX17082/MAX17482: DPRSLPVR, \overline{SLOW} MAX17021: \overline{DPRSTP}	0.67			V
Low-Voltage Logic Input Low Voltage	V_{ILLV}	$\overline{PS1}$, D0-D6: MAX17082/MAX17482: DPRSLPVR, \overline{SLOW} MAX17021: \overline{DPRSTP}			0.33	V

Note 2: When pulse skipping, the output rises by approximately 1.5% when transitioning from continuous conduction to no load.

Note 3: On-time and minimum off-time specifications are measured from 50% to 50% at the DH_ and DL_ pins, with LX_ forced to GND, BST_ forced to 5V, and a 500pF capacitor from DH_ to LX_ to simulate external MOSFET gate capacitance. Actual in-circuit times might be different due to MOSFET switching speeds.

Note 4: Specifications to $T_A = -40^\circ C$ and $+105^\circ C$ are guaranteed by design and are not production tested.

Dual-Phase, Quick-PWM Controllers for IMVP-6+/IMVP-6.5 CPU Core Power Supplies

Typical Operating Characteristics

(Circuit of Figure 1. $V_{IN} = 12V$, $V_{CC} = V_{DD} = 5V$, $\overline{SHDN} = V_{CC}$, D0–D6 set for 1.075V, $T_A = +25^\circ C$, unless otherwise specified.)

MAX17021/MAX17082/MAX17482

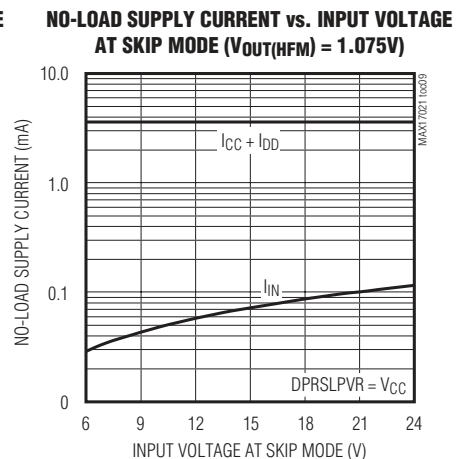
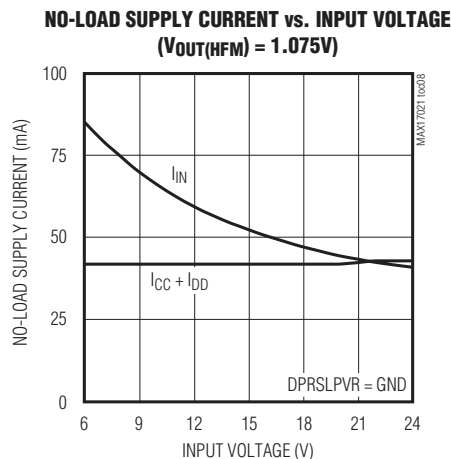
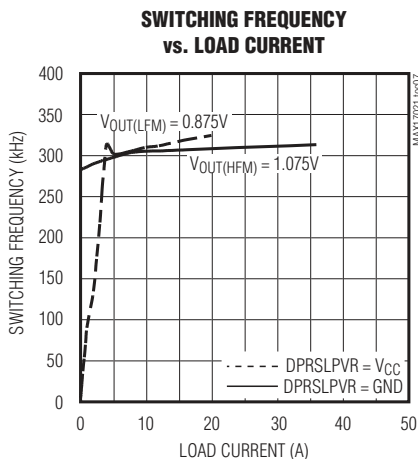
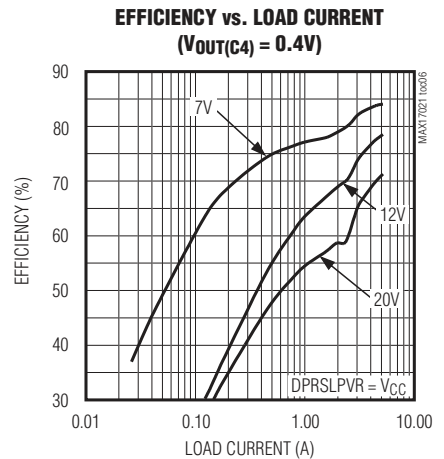
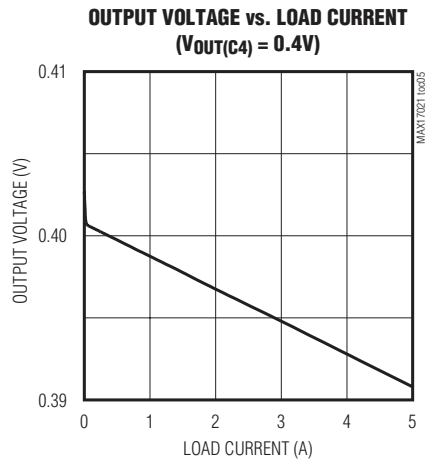
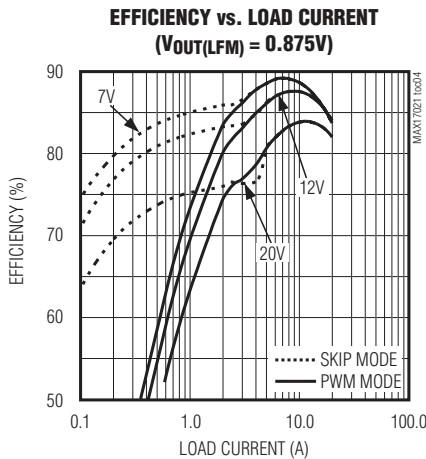
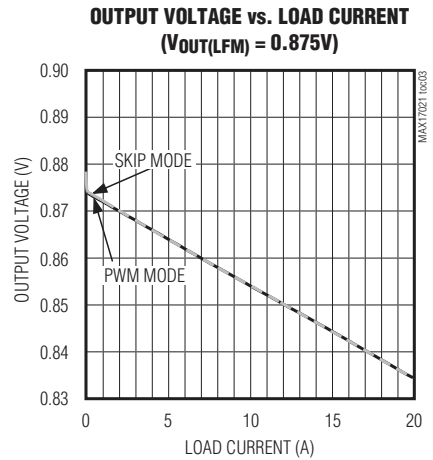
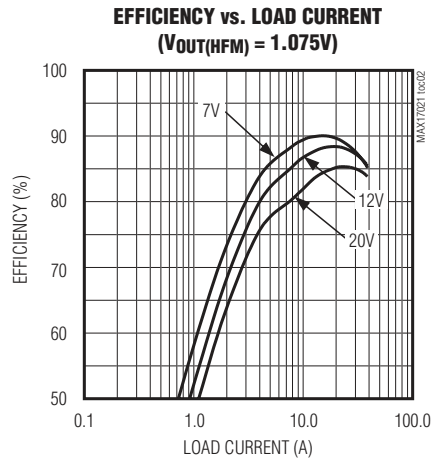
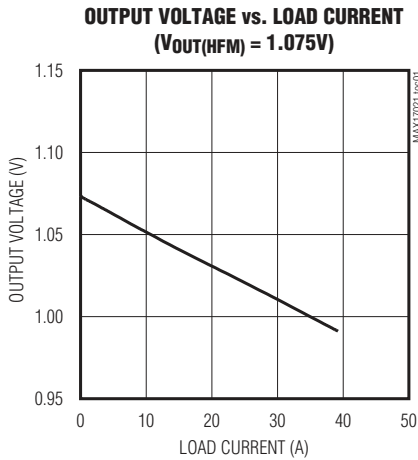

Dual-Phase, Quick-PWM Controllers for IMVP-6+/IMVP-6.5 CPU Core Power Supplies

Typical Operating Characteristics (continued)

(Circuit of Figure 1. $V_{IN} = 12V$, $V_{CC} = V_{DD} = 5V$, $\overline{SHDN} = V_{CC}$, D0–D6 set for 1.075V, $T_A = +25^\circ C$, unless otherwise specified.)

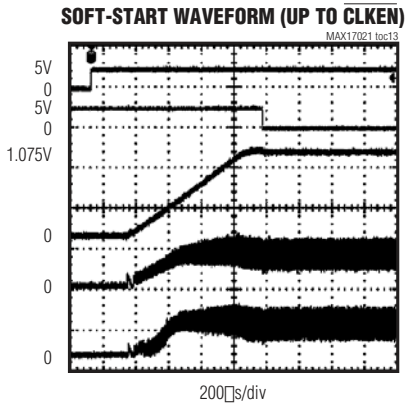
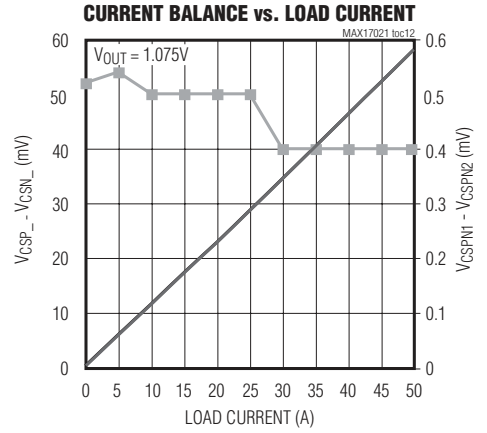
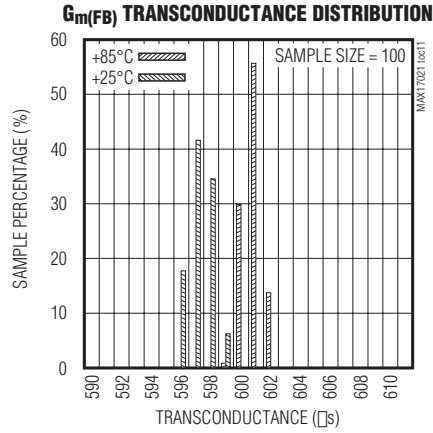
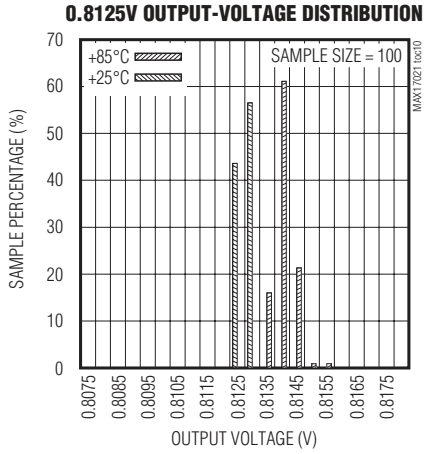

A. \overline{SHDN} , 10V/div
 B. CLKEN, 10V/div
 C. V_{OUT} , 500mV/div
 D. I_{LX1} , 10A/div
 E. I_{LX2} , 10A/div
 $I_{OUT} = 15A$

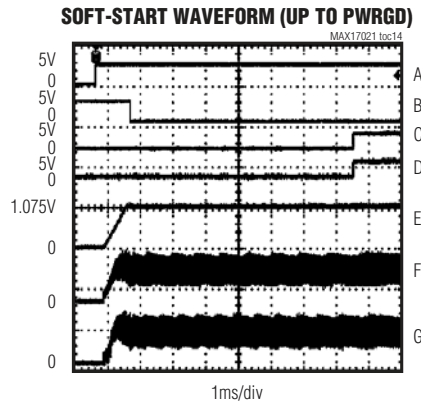

A. \overline{SHDN} , 10V/div
 B. PWRGD, 10V/div
 C. PHASEGD, 10V/div
 D. CLKEN, 10V/div
 E. V_{OUT} , 1V/div
 F. I_{LX1} , 10A/div
 G. I_{LX2} , 10A/div
 $I_{OUT} = 15A$

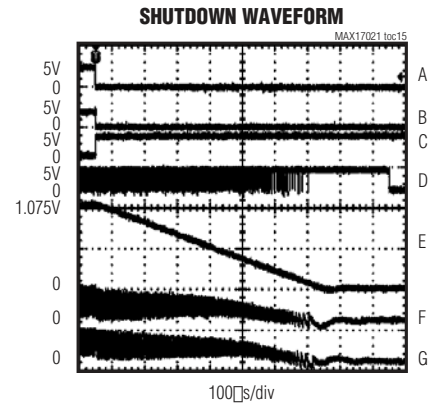

A. \overline{SHDN} , 10V/div
 B. CLKEN, 10V/div
 C. PWRGD, 10V/div
 D. DL_- , 10V/div
 E. V_{OUT} , 500mV/div
 F. I_{LX1} , 10A/div
 G. I_{LX2} , 10A/div

Dual-Phase, Quick-PWM Controllers for IMVP-6+/IMVP-6.5 CPU Core Power Supplies

Typical Operating Characteristics (continued)

(Circuit of Figure 1. $V_{IN} = 12V$, $V_{CC} = V_{DD} = 5V$, $\overline{SHDN} = V_{CC}$, D0–D6 set for 1.075V, $T_A = +25^\circ C$, unless otherwise specified.)

LOAD TRANSIENT RESPONSE (HFM MODE)

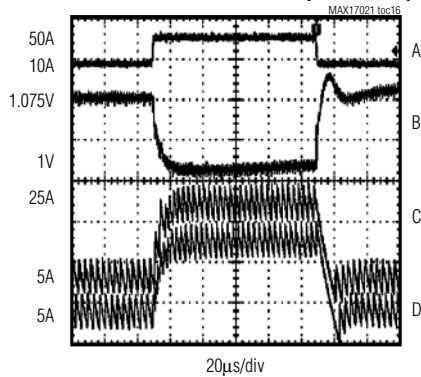

A. $I_{OUT} = 10A$ TO $50A$
B. V_{OUT} , 50mV/div
C. I_{LX1} , 10A/div
D. I_{LX2} , 10A/div

LOAD-TRANSIENT RESPONSE (LFM MODE)

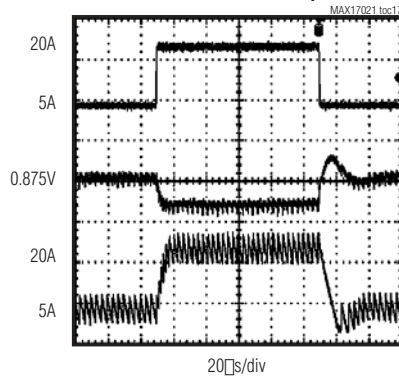

A. $I_{OUT} = 5A$ TO $20A$
B. V_{OUT} , 50mV/div
C. INDUCTOR CURRENT, 10A/div

VID CODE CHANGE ($\overline{SLOW} = GND$)

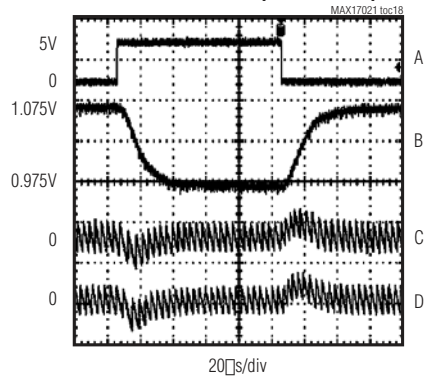

A. VID3, 5V/div
B. V_{OUT} , 50mV/div
C. I_{LX1} , 10A/div
D. I_{LX2} , 10A/div

VID CODE CHANGE ($\overline{SLOW} = V_{DD}$)

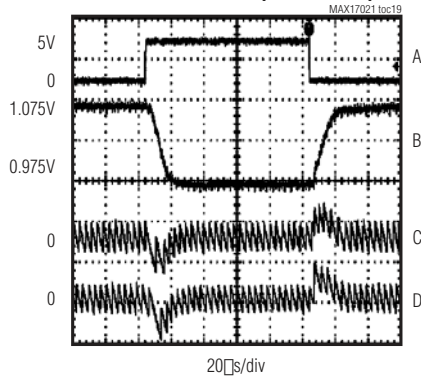

A. VID3, 5V/div
B. V_{OUT} , 50mV/div
C. I_{LX1} , 10A/div
D. I_{LX2} , 10A/div

DYNAMIC VID CODE CHANGE ($D0 = 12.5mV$)

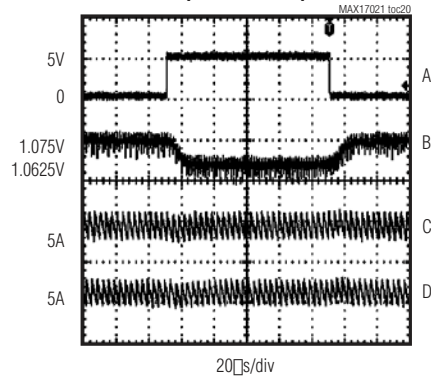

A. D0, 5V/div
B. V_{OUT} , 20mV/div
 $I_{OUT} = 10A$
C. I_{LX1} , 10A/div
D. I_{LX2} , 10A/div

OUTPUT UNDERVOLTAGE FAULT

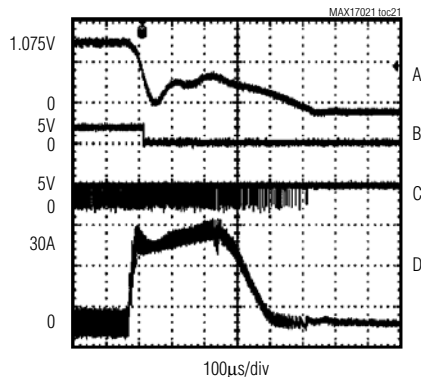

A. V_{OUT} , 500mV/div
B. PWRGD, 10V/div
C. DL-, 10V/div
D. I_{LX1} , 15A/div

VIMON vs. LOAD CURRENT

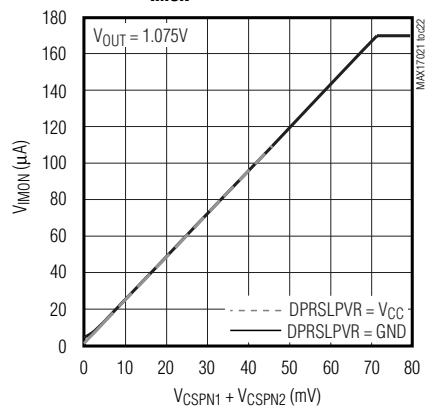

MAX17021/MAX17082/MAX17482

Dual-Phase, Quick-PWM Controllers for IMVP-6+/IMVP-6.5 CPU Core Power Supplies

Typical Operating Characteristics (continued)

(Circuit of Figure 1. $V_{IN} = 12V$, $V_{CC} = V_{DD} = 5V$, $\overline{SHDN} = V_{CC}$, D0–D6 set for 1.075V, $T_A = +25^\circ C$, unless otherwise specified.)

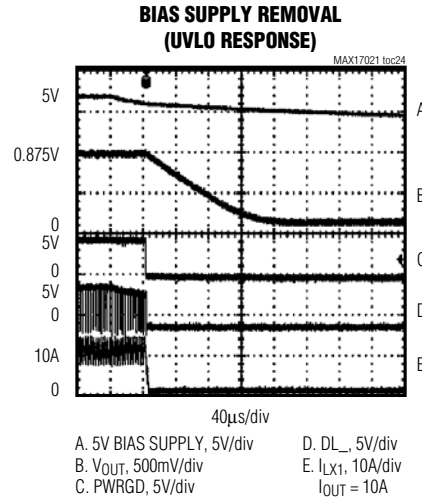
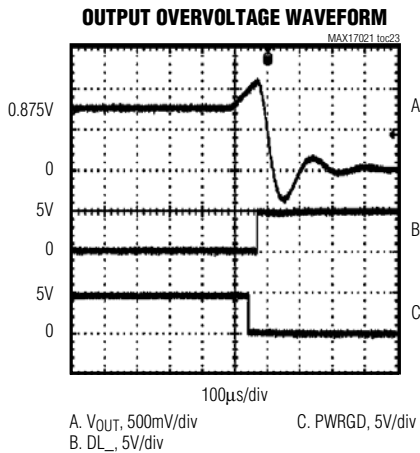

Pin Description

PIN	NAME	FUNCTION
1	PGDIN	System Power-Good Logic Input. PGDIN indicates the power status of other system rails and is used for power-supply sequencing. After power-up to the boot voltage, the output voltage remains at V _{BOOT} , \overline{CLKEN} remains high, and PWRGD remains low as long as the PGDIN stays low. When PGDIN is pulled high, the output transitions to selected VID voltage, and \overline{CLKEN} is pulled low. If the system pulls PGDIN low during normal operation, the MAX17021/MAX17082/MAX17482 immediately drive \overline{CLKEN} high, pull PWRGD low, and slew the output to the boot voltage (using two-phase pulse-skipping mode). The controller remains at the boot voltage until PGDIN goes high again, \overline{SHDN} is toggled, or the V _{CC} input power supply is cycled.
2	THRM	Input of Internal Comparator. Connect the output of a resistor- and thermistor-divider (between V _{CC} and GND) to THRM. Select the components such that the voltage at THRM falls below 1.5V (30% of V _{CC}) at the desired high temperature.
3	IMON (MAX17082/ MAX17482 only)	Current-Monitor Output. The MAX17082/MAX17482 IMON output source a current that is directly proportional to the current-sense voltage as defined by: $I_{IMON} = G_m(IMON) \times (V_{CSP_} - V_{CSN_})$ where $G_m(IMON) = 2.4mS$ (typ). The IMON current is unidirectional (sources current out of IMON only) for positive current-sense values. For negative current-sense voltages, the IMON current is zero. Connect an external resistor between IMON and VSS_SENSE to create the desired IMON gain based on the following equation: $R_{IMON} = 0.999V / (IMAX \times R_{SENSE} \times G_m(IMON))$ where IMAX is defined in the <i>Current Monitor</i> section of the Intel IMVP-6.5 specification and based on discrete increments (20A, 30A, 40A, etc.), R _{SENSE} is the typical effective value of the current-sense element (sense resistor or inductor DCR) that is used to provide the current-sense voltage, and G _m (IMON) is the typical transconductance amplifier gain as defined in the <i>Electrical Characteristics</i> table. The IMON voltage is internally clamped to a maximum of 1.1V (typ). The transconductance amplifier and voltage clamp are internally compensated, so IMON cannot directly drive large capacitance values. To filter the IMON signal, use an RC filter as shown in Figure 2. IMON is pulled to ground when MAX17082/MAX17482 are in shutdown.

Dual-Phase, Quick-PWM Controllers for IMVP-6+/IMVP-6.5 CPU Core Power Supplies

Pin Description (continued)

PIN	NAME	FUNCTION
4	ILIM	Valley Current-Limit Adjustment Input. The valley current-limit threshold voltage at CSP_ to CSN_ equals precisely 1/10 of the differential TIME to ILIM voltage over a 0.1V to 0.5V range (10mV to 50mV current-sense range). The negative current-limit threshold is nominally -125% of the corresponding valley current-limit threshold. Connect ILIM directly to V _{CC} to set the default current-limit threshold setting of 22.5mV (typ) nominal.
5	TIME	Slew-Rate Adjustment Pin. TIME regulates to 2.0V and the load current determines the slew rate of the internal error-amplifier target. The sum of the resistance between TIME and GND (R _{TIME}) determines the nominal slew-rate: $\text{SLEW RATE} = (12.5\text{mV}/\mu\text{s}) \times (71.5\text{k}\Omega/\text{RTIME})$ The guaranteed R _{TIME} range is between 35.7k Ω and 178k Ω . This “nominal” slew rate applies to VID transitions and to the transition from boot mode to VID. If the VID DAC inputs are clocked, the slew rate for all other VID transitions is set by the rate at which they are clocked, up to a maximum slew rate equal to the nominal slew rate defined above. The startup and shutdown slew rates are always 1/8 of nominal slew rate in order to minimize surge currents. MAX17021: If both DPRSLPVR and $\overline{\text{DPRSTP}}$ are pulled high, then the slew rate is reduced to 1/4 of nominal. MAX17082/MAX17482: If $\overline{\text{SLOW}}$ is low, then the slew rate is reduced to 1/2 of nominal.
6	V _{CC}	Controller Analog Bias Supply Voltage. Connect to a 4.5V to 5.5V source. Bypass to GND with 1 μ F minimum.
7	CCI	Current-Balance Compensation. Connect a 470pF capacitor between CCI and the positive side of the feedback remote sense. CCI is internally forced low in shutdown.
8	FB	Remote Feedback-Sense Input. Normally shorted to FBAC and connected to the V _{CC} _SENSE pin of the CPU socket through the load-line gain resistor (see the FBAC pin description). FB internally connects to the error amplifier and integrator.
9	FBAC	Voltage-Positioning Transconductance Amplifier Output. Connect a resistor R _{FB} between FBAC and the positive side of the feedback remote sense to set the DC steady-state droop based on the voltage-positioning gain requirement: $R_{\text{FB}} = R_{\text{DROOP}} / (R_{\text{SENSE}} \times G_{\text{m(FBAC)}})$ where R _{DROOP} is the desired voltage-positioning slope and G _{m(FBAC)} = 600 μ S (typ). R _{SENSE} is the value of the current-sense resistors that are used to provide the (CSP_, CSN_) current-sense voltages. If lossless sensing is used, R _{SENSE} = R _L . In this case, consider making R _{FB} a resistor network that includes an NTC thermistor to minimize the temperature dependence of the voltage-positioning slope. FBAC is high impedance in shutdown.
10	GNDS	Remote Ground-Sense Input. Normally connected to the V _{SS} _SENSE pin of the CPU socket. GNDS internally connects to a transconductance amplifier that fine tunes the output voltage—compensating for voltage drops from the regulator ground to the load ground.
11	CSN2	Negative Current-Sense Input for Phase 2. Connect CSN2 to the negative terminal of the inductor current-sensing resistor or directly to the negative terminal of the inductor if the lossless DCR sensing method is used (see Figure 4).
12	CSP2	Positive Current-Sense Input for Phase 2. Connect CSP2 to the positive terminal of the inductor current-sensing resistor or directly to the positive terminal of the filtering capacitor used when the lossless DCR sensing method is used (see Figure 4). Short CSP2 to V _{CC} for dedicated one-phase operation.

MAX17021/MAX17082/MAX17482

Dual-Phase, Quick-PWM Controllers for IMVP-6+/IMVP-6.5 CPU Core Power Supplies

Pin Description (continued)

PIN	NAME	FUNCTION															
13	$\overline{\text{SHDN}}$	Shutdown Control Input. This input cannot withstand the battery voltage. Connect to V_{CC} for normal operation. Connect to ground to put the IC into its 1 μ A max shutdown state. During startup, the output voltage is ramped up to the boot voltage slowly at a slew rate that is 1/8 the slew rate set by the TIME resistor. During the transition from normal operation to shutdown, the output voltage is ramped down at the same slow slew rate. Forcing $\overline{\text{SHDN}}$ to 11V~13V disables both overvoltage-protection and undervoltage-protection circuits, clears the fault latch, disables transient phase overlap, and disables the BST_ charging switches. Do not connect $\overline{\text{SHDN}}$ to > 13V.															
14	DPRSLPVR	<p>Pulse-Skipping Control Input. This 1.0V logic input signal indicates power usage and sets the operating mode of MAX17021/MAX17082/MAX17482. When DPRSLPVR is forced high, the controller immediately enters the automatic pulse-skipping mode. The controller returns to forced-PWM mode when DPRSLPVR is forced low and the output is in regulation. The PWRGD upper threshold is blanked during any downward output-voltage transition that occurs when the controller is in pulse-skipping mode, and stays blanked until the transition-related PWRGD blanking period is complete and the output reaches regulation. The output overvoltage fault threshold is changed from a tracking [VID + 300mV] threshold to a fixed-default transitional OVP threshold during the period for which the PWRGD upper threshold is blanked.</p> <p>The MAX17082 is in two-phase pulse-skipping mode during startup and while in boot mode, but is in forced-PWM mode during the transition from boot mode to VID mode plus 20μs, and during soft-shutdown, irrespective of the DPRSLPVR logic level.</p> <p>DPRSLPVR and $\overline{\text{PSI}}$ together determine the operating mode and the number of active phases as shown in the following truth table:</p> <table border="1"> <thead> <tr> <th>DPRSLPVR</th> <th>$\overline{\text{PSI}}$</th> <th>MODE AND PHASES</th> </tr> </thead> <tbody> <tr> <td>1</td> <td>0</td> <td>Very low current (one-phase pulse skipping)</td> </tr> <tr> <td>1</td> <td>1</td> <td>Low current (approx 3A) (one-phase pulse skipping)</td> </tr> <tr> <td>0</td> <td>0</td> <td>Intermediate power potential (one-phase PWM)</td> </tr> <tr> <td>0</td> <td>1</td> <td>Max power potential (two- or one-phase PWM as configured at CSP2)</td> </tr> </tbody> </table>	DPRSLPVR	$\overline{\text{PSI}}$	MODE AND PHASES	1	0	Very low current (one-phase pulse skipping)	1	1	Low current (approx 3A) (one-phase pulse skipping)	0	0	Intermediate power potential (one-phase PWM)	0	1	Max power potential (two- or one-phase PWM as configured at CSP2)
DPRSLPVR	$\overline{\text{PSI}}$	MODE AND PHASES															
1	0	Very low current (one-phase pulse skipping)															
1	1	Low current (approx 3A) (one-phase pulse skipping)															
0	0	Intermediate power potential (one-phase PWM)															
0	1	Max power potential (two- or one-phase PWM as configured at CSP2)															
15	$\overline{\text{PSI}}$	Power-State Indicator Input. DPRSLPVR and $\overline{\text{PSI}}$ together determine the operating mode and the number of active phases as shown in the truth table included under the $\overline{\text{PSI}}$ pin description above.															
16	TON	<p>Switching Frequency Setting Input. An external resistor between the input power source and TON sets the switching period ($T_{SW} = 1/f_{SW}$) per phase according to the following equation:</p> $T_{SW} = 16.3\text{pF} \times (R_{TON} + 6.5\text{k}\Omega)$ <p>TON becomes high impedance in shutdown to reduce the input quiescent current. If the TON current is less than 10μA, the MAX17021/MAX17082/MAX17482 disable the controller, set the TON open fault latch, and pull DL_ and DH_ low.</p>															
17	V3P3	3.3V CLKEN Input Supply. V3P3 input supplies the $\overline{\text{CLKEN}}$ CMOS push-pull logic output. Connect to the system's standard 3.3V supply voltage before $\overline{\text{SHDN}}$ is pulled high for proper IMVP-6.5 operation.															
18	$\overline{\text{CLKEN}}$	Clock Enable Push-Pull Logic Output. This inverted logic output indicates when the output voltage sensed at FB is in regulation. During soft-start, shutdown, and when the FB is out of regulation, the MAX17021/MAX17082/MAX17482 pull $\overline{\text{CLKEN}}$ up to V3P3. During VID transitions, the controller forces $\overline{\text{CLKEN}}$ low. Except during the power-up sequence, $\overline{\text{CLKEN}}$ is the inverse of PWRGD. See the <i>Startup Timing Diagram</i> (Figure 10). When in pulse-skipping mode (DPRSLPVR high), the upper $\overline{\text{CLKEN}}$ threshold is disabled.															
19	PWRGD	<p>Open-Drain Power-Good Output. After output-voltage transitions, except during power-up and power-down; if FB is in regulation then PWRGD is high impedance.</p> <p>During startup, PWRGD is held low and continues to be low while the part is in boot mode and until 5ms (typ) after $\overline{\text{CLKEN}}$ goes low.</p> <p>PWRGD is forced low in shutdown.</p> <p>PWRGD is forced high impedance whenever the slew-rate controller is active (output-voltage transitions). When in pulse-skipping mode (DPRSLPVR high), the upper PWRGD threshold comparator is blanked during downward transitions.</p> <p>A pullup resistor on PWRGD causes additional finite shutdown current.</p>															

Dual-Phase, Quick-PWM Controllers for IMVP-6+/IMVP-6.5 CPU Core Power Supplies

Pin Description (continued)

MAX17021/MAX17082/MAX17482

PIN	NAME	FUNCTION															
20	PHASEGD	Phase-Good Current-Balance Open-Drain Output. Used to signal the system that one of the two phases either has a fault condition or is not matched with the other. Detection is done by identifying the need for a large on-time difference between phases in order to achieve or move towards current balance. PHASEGD is low in shutdown. PHASEGD is forced high impedance whenever the slew-rate controller is active (output-voltage transitions). PHASEGD is forced high impedance while in one-phase operation (DPRSLPVR = high or $\overline{\text{PSI}}$ = low).															
21	BST2	Boost Flying-Capacitor Connection for Phase 2. BST2 provides the upper supply rail for the DH2 high-side gate driver. An internal switch between V_{DD} and BST2 charges the flying capacitor while the low-side MOSFET is on (DL2 pulled high and LX2 pulled to ground).															
22	LX2	Inductor Connection for Phase 2. LX2 is the internal lower supply rail for the DH2 high-side gate driver. Also used as an input to the controller's zero-crossing comparator for phase 2.															
23	DH2	High-Side Gate-Driver Output for Phase 2. DH2 swings from LX2 to BST2. The controller pulls DH2 low in shutdown.															
24	DL2	Low-Side Gate-Driver Output for Phase 2. DL2 swings from GND to V_{DD} . DL2 is forced low in skip mode after detecting an inductor current zero crossing. DL2 is forced low during one-phase operation ($\overline{\text{PSI}}$ = GND or CSP2 = V_{CC}).															
25	$\overline{\text{VRHOT}}$	Open-Drain Output of Internal Comparator. $\overline{\text{VRHOT}}$ is pulled low when the voltage at THRM goes below 1.5V (30% of V_{CC}). $\overline{\text{VRHOT}}$ is high impedance in shutdown.															
26	V_{DD}	Driver Supply Voltage Input. V_{DD} is the supply voltage used to internally power the low-side gate drivers and refresh the BST_ flying capacitors during the off-times. Connect V_{DD} to the 4.5V to 5.5V system supply voltage. Bypass V_{DD} to the system power ground with a 1 μ F each or greater ceramic capacitor.															
27	DL1	Low-Side Gate-Driver Output for Phase 1. DL1 swings from GND to V_{DD} . DL1 is forced high when an output overvoltage fault is detected, overriding any negative current-limit condition that might be present. DL1 is forced low after soft-shutdown or in skip mode after detecting an inductor current zero crossing.															
28	DH1	High-Side Gate-Driver Output for Phase 1. DH1 swings from LX1 to BST1. The controller pulls DH1 low in shutdown.															
29	LX1	Inductor Connection for Phase 1. LX1 is the internal lower supply rail for the DH1 high-side gate driver. Also used as an input to the controller's zero-crossing comparator for phase 1.															
30	BST1	Boost Flying-Capacitor Connection for Phase 1. BST1 provides the upper supply rail for the DH1 high-side gate driver. An internal switch between V_{DD} and BST1 charges the flying capacitor while the low-side MOSFET is on (DL1 is pulled high and LX1 is pulled to ground).															
31	$\overline{\text{DPRSTP}}$ (MAX17021)	IMVP-6+ Slew-Rate Select Input. This 1.0V logic input signal from the IMVP-6+ system is usually the logical complement of the DPRSLPVR signal. However, the IMVP-6+ specification supports a special slow C4 exit condition that allows both $\overline{\text{DPRSTP}}$ and DPRSLPVR to be pulled high simultaneously. When this occurs, the voltage-transition slew rate reduces to 1/4 the nominal (R_{TIME} -based) slew rate for the duration of this logic condition. The slew rate returns to normal when either DPRSLPVR or $\overline{\text{DPRSTP}}$ is pulled low: <table border="1" style="margin-left: auto; margin-right: auto;"> <thead> <tr> <th>DPRSLPVR</th> <th>$\overline{\text{DPRSTP}}$</th> <th>SLEW RATE</th> </tr> </thead> <tbody> <tr> <td>0</td> <td>0</td> <td>Nominal slew rate</td> </tr> <tr> <td>0</td> <td>1</td> <td>Nominal slew rate</td> </tr> <tr> <td>1</td> <td>0</td> <td>Nominal slew rate</td> </tr> <tr> <td>1</td> <td>1</td> <td>Slew rate reduced to 1/4 of nominal</td> </tr> </tbody> </table>	DPRSLPVR	$\overline{\text{DPRSTP}}$	SLEW RATE	0	0	Nominal slew rate	0	1	Nominal slew rate	1	0	Nominal slew rate	1	1	Slew rate reduced to 1/4 of nominal
	DPRSLPVR	$\overline{\text{DPRSTP}}$	SLEW RATE														
0	0	Nominal slew rate															
0	1	Nominal slew rate															
1	0	Nominal slew rate															
1	1	Slew rate reduced to 1/4 of nominal															
$\overline{\text{SLOW}}$ (MAX17082/ MAX17482)	IMVP-6.5 Slew-Rate Select Input. This 1.0V logic input signal selects between the nominal and "slow" (half of nominal rate) slew rates. When $\overline{\text{SLOW}}$ is forced high, the selected nominal slew rate is set by the TIME resistance as defined above. When $\overline{\text{SLOW}}$ is forced low, the slew rate is reduced to half the nominal slew rate.																

Dual-Phase, Quick-PWM Controllers for IMVP-6+/IMVP-6.5 CPU Core Power Supplies

Pin Description (continued)

PIN	NAME	FUNCTION
32–38	D0–D6	Low-Voltage VID DAC Code Input. The D0–D6 inputs do not have internal pullups. These 1.0V logic inputs are designed to interface directly with the CPU. The output voltage is set by the VID code indicated by the logic-level voltages on D0–D6 (see Table 4).
39	CSP1	Positive Current-Sense Input for Phase 1. Connect CSP1 to the positive terminal of the inductor current-sensing resistor or directly to the positive terminal of the filtering capacitor used when the lossless DCR sensing method is used (see Figure 4).
40	CSN1	Negative Current-Sense Input for Phase 1. Connect CSN1 to the negative terminal of the inductor current-sensing resistor or directly to the negative terminal of the inductor if the lossless DCR sensing method is used (see Figure 4). Under V_{CC} UVLO conditions and after soft-shutdown is completed, CSN1 is internally pulled to GND through a 10Ω FET to discharge the output.
—	EP	Exposed Pad. Internally connected to GND. Connect to the ground plane through a thermally enhanced via. For the MAX17021/MAX17082/MAX17482, the exposed pad is the only GND connection and must be properly soldered.

Dual-Phase, Quick-PWM Controllers for IMVP-6+/IMVP-6.5 CPU Core Power Supplies

MAX17021/MAX17082/MAX17482

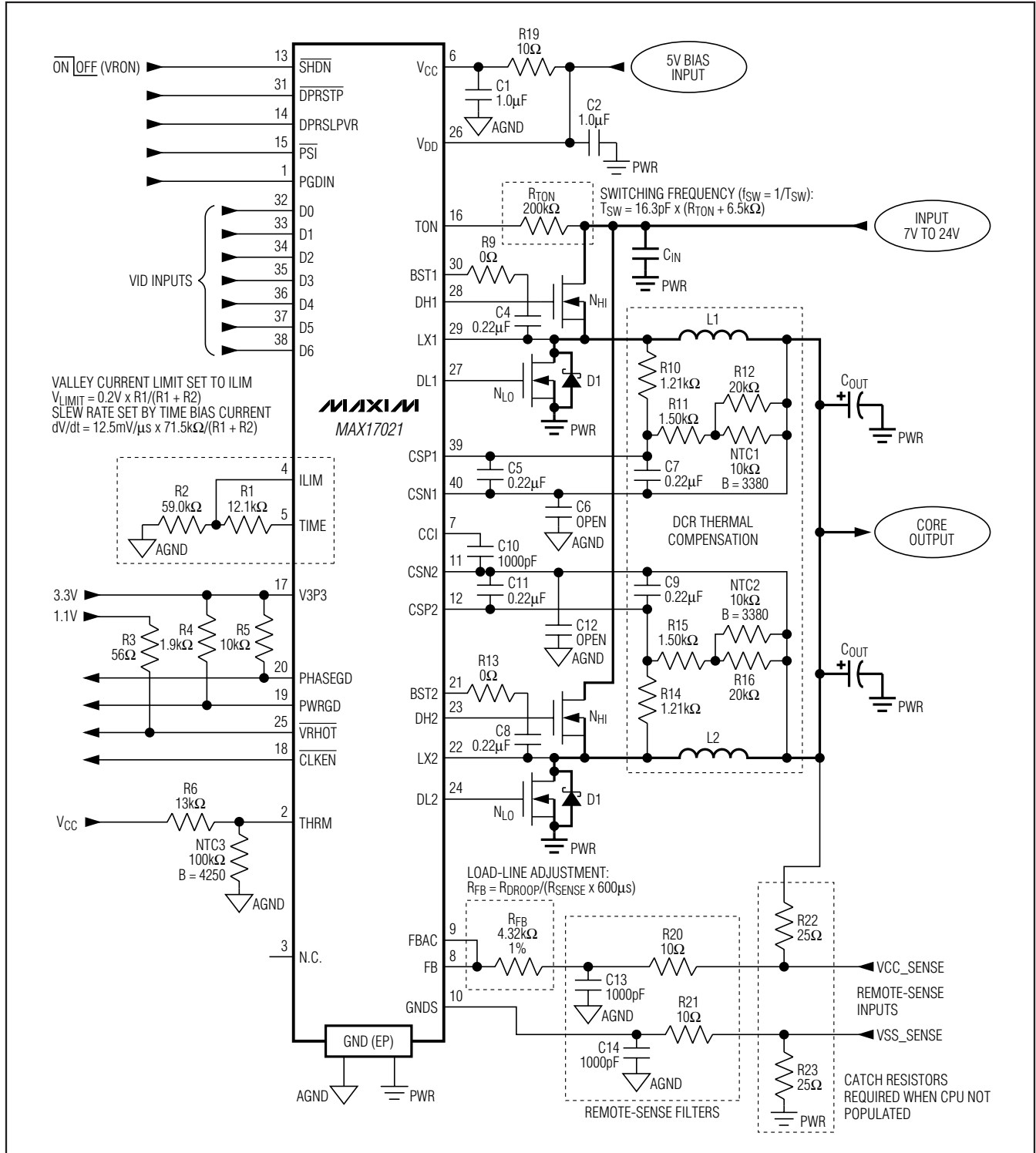

Figure 1. Standard 2-Phase IMVP-6+ Application Circuit

Dual-Phase, Quick-PWM Controllers for IMVP-6+/IMVP-6.5 CPU Core Power Supplies

Detailed Description

Table 1 lists the component selection for standard applications. Table 2 lists component suppliers for the MAX17021/MAX17082/MAX17482/MAX17482.

Free-Running, Constant-On-Time PWM Controller with Input Feed-Forward

The Quick-PWM control architecture is a pseudo-fixed-frequency, constant-on-time, current-mode regulator with voltage feed-forward (Figure 3). This architecture relies on the output filter capacitor's ESR to act as the current-sense resistor, so the output ripple voltage provides the PWM ramp signal. The control algorithm is

simple: the high-side switch on-time is determined solely by a one-shot whose period is inversely proportional to input voltage, and directly proportional to output voltage or the difference between the main and secondary inductor currents (see the *On-Time One-Shot* section). Another one-shot sets a minimum off-time. The on-time one-shot triggers when the error comparator goes low, the inductor current of the selected phase is below the valley current-limit threshold, and the minimum off-time one-shot times out. The controller maintains 180° out-of-phase operation by alternately triggering the main and secondary phases after the error comparator drops below the output-voltage set point.

Table 1. Component Selection for Standard Applications

DESIGN PARAMETERS	IMVP-6+ SV	IMVP-6+ LV	IMVP-6.5 AUBURNDALE SV CORE	IMVP-6.5 AUBURNDALE LV CORE
CIRCUIT	FIGURE 1	FIGURE 1	FIGURE 2	FIGURE 2
Input-Voltage Range	7V to 20V	7V to 20V	7V to 20V	7V to 20V
Maximum Load Current (TDC Current)	44A (34A)	23A (19A)	50A (37A)	28A (19A)
Transient Load Current	35A (10A/μs)	18A (10A/μs)	35A (10A/μs)	23A (10A/μs)
Load Line	-2.1mV/A	-4mV/A	-1.9mV/A	-3mV/A
COMPONENTS				
TON Resistance (R _{TON})	200kΩ (f _{SW} = 300kHz)	200kΩ (f _{SW} = 300kHz)	200kΩ (f _{SW} = 300kHz)	200kΩ (f _{SW} = 300kHz)
Inductance (L)	NEC/TOKIN MPC1055LR36 0.36μH, 32A, 0.8mΩ	NEC/TOKIN MPC1055LR36 0.36μH, 32A, 0.8mΩ	NEC/TOKIN MPC1055LR36 0.36μH, 32A, 0.8mΩ	NEC/TOKIN MPC1055LR36 0.36μH, 32A, 0.8mΩ
High-Side MOSFET (N _H)	Siliconix 1x Si4386DY 7.8m /9.5mΩ (typ/max)	Siliconix 1x Si4386DY 7.8m /9.5mΩ (typ/max)	Siliconix 1x Si4386DY 7.8m /9.5mΩ (typ/max)	Siliconix 1x Si4386DY 7.8m /9.5mΩ (typ/max)
Low-Side MOSFET (N _L)	Siliconix 2x Si4642DY 3.9m /4.7mΩ (typ/max)	Siliconix 2x Si4642DY 3.9m /4.7mΩ (typ/max)	Siliconix 2x Si4642DY 3.9m /4.7mΩ (typ/max)	Siliconix 2x Si4642DY 3.9m /4.7mΩ (typ/max)
Output Capacitors (C _{OUT})	4x 330μF, 6mΩ, 2.5V Panasonic EEFSX0D0D331XR 28x 10μF, 6V ceramic (0805)	3x 330μF, 6mΩ, 2.5V Panasonic EEFSX0D0D331XR 28x 10μF, 6V ceramic (0805)	4x 330μF, 6mΩ, 2.5V Panasonic EEFSX0D0D331XR 28x 10μF, 6V ceramic (0805)	3x 330μF, 6mΩ, 2.5V Panasonic EEFSX0D0D331XR 28x 10μF, 6V ceramic (0805)
Input Capacitors (C _{IN})	4x 10μF, 25V ceramic (1210)	4x 10μF, 25V ceramic (1210)	4x 10μF, 25V ceramic (1210)	4x 10μF, 25V ceramic (1210)

Dual-Phase, Quick-PWM Controllers for IMVP-6+/IMVP-6.5 CPU Core Power Supplies

MAX17021/MAX17082/MAX17482

Table 1. Component Selection for Standard Applications (continued)

DESIGN PARAMETERS	IMVP-6+ SV	IMVP-6+ LV	IMVP-6.5 AUBURNDALE SV CORE	IMVP-6.5 AUBURNDALE LV CORE
TIME-ILIM Resistance (R1)	10kΩ	10kΩ	10kΩ	10kΩ
ILIM-GND Resistance (R2)	59kΩ	59kΩ	59kΩ	59kΩ
FB Resistance (R _{FB})	4.32kΩ	8.45kΩ	4.02kΩ	6.34kΩ
IMON Resistance	N/A	N/A	9.09kΩ	18.2kΩ
LX_-CSP_ Resistance	1.21kΩ	1.21kΩ	1.21kΩ	1.21kΩ
CSP_-CSN_ Series Resistance (R6)	1.50kΩ	1.50kΩ	1.50kΩ	1.50kΩ
Parallel NTC Resistance	20kΩ	20kΩ	20kΩ	20kΩ
DCR Sense NTC (NTC1)	10kΩ NTC B = 3380 TDK NTCG163JH103F	10kΩ NTC B = 3380 TDK NTCG163JH103F	10kΩ NTC B = 3380 TDK NTCG163JH103F	10kΩ NTC B = 3380 TDK NTCG163JH103F
DCR Sense Capacitance (C _{SENSE})	2x 0.22μF, 6V ceramic (0805)	2x 0.22μF, 6V ceramic (0805)	2x 0.22μF, 6V ceramic (0805)	2x 0.22μF, 6V ceramic (0805)

Table 2. Component Suppliers

SUPPLIER	WEBSITE
AVX Corp.	www.avxcorp.com
BI Technologies	www.bitechnologies.com
Central Semiconductor Corp.	www.centrasemi.com
Fairchild Semiconductor	www.fairchildsemi.com
International Rectifier	www.irf.com
KEMET Corp	www.kemet.com
NEC/TOKIN Corp.	www.nec-tokin.com
Panasonic Corp.	www.panasonic.com

SUPPLIER	WEBSITE
Pulse Engineering	www.pulseeng.com
Renesas Technology Corp.	www.renesas.com
SANYO Electric Co, Ltd.	www.sanyodevice.com
Siliconix (Vishay)	www.vishay.com
Sumida	www.sumida.com
Taiyo Yuden	www.t-yuden.com
TDK Corp.	www.component.tdk.com
TOKO America, Inc.	www.tokoam.com

Dual-Phase, Quick-PWM Controllers for IMVP-6+/IMVP-6.5 CPU Core Power Supplies

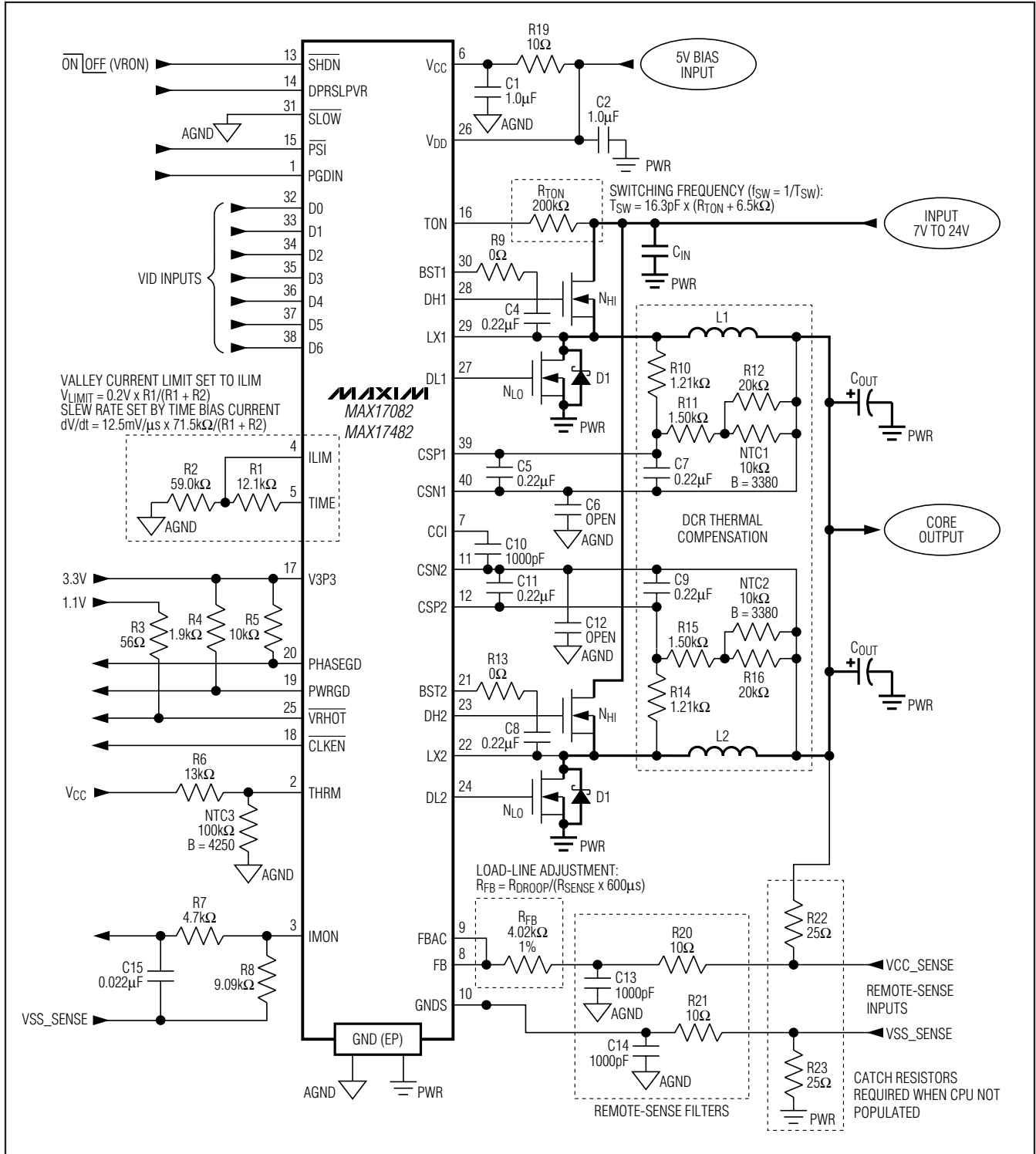

Figure 2. Standard 2-Phase IMVP-6.5 (Calpella) Application Circuit

Dual-Phase, Quick-PWM Controllers for IMVP-6+/IMVP-6.5 CPU Core Power Supplies

MAX17021/MAX17082/MAX17482

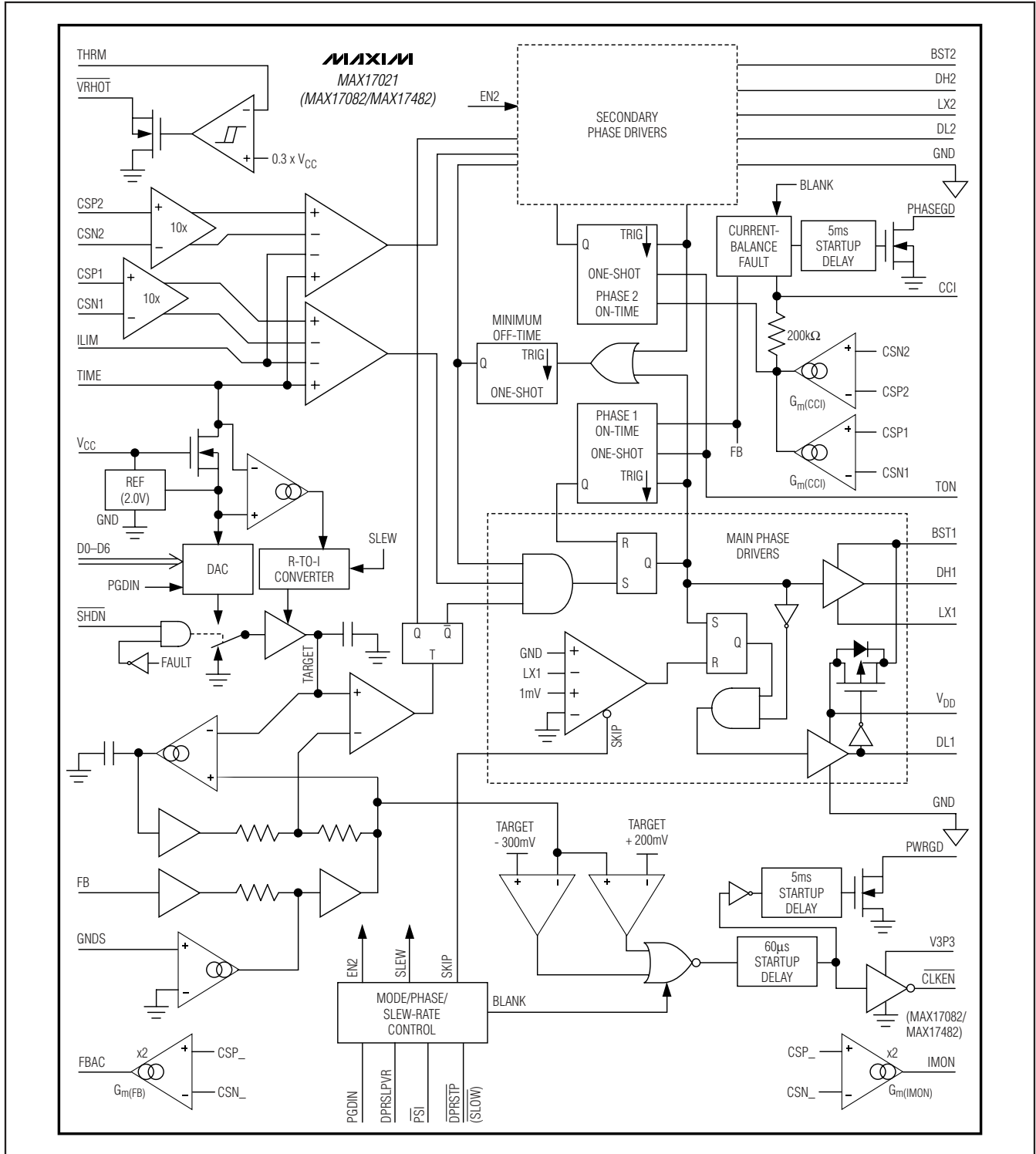

Figure 3. Functional Diagram

Dual-Phase, Quick-PWM Controllers for IMVP-6+/IMVP-6.5 CPU Core Power Supplies

Dual 180° Out-of-Phase Operation

The two phases in the MAX17021/MAX17082/MAX17482 operate 180° out-of-phase to minimize input and output filtering requirements, reduce electromagnetic interference (EMI), and improve efficiency. This effectively lowers component count—reducing cost, board space, and component power requirements—making the MAX17021/MAX17082/MAX17482 ideal for high-power, cost-sensitive applications.

Typically, switching regulators provide power using only one phase instead of dividing the power among several phases. In these applications, the input capacitors must support high instantaneous current requirements. The high RMS ripple current can lower efficiency due to I²R power loss associated with the input capacitor's effective series resistance (ESR). Therefore, the system typically requires several low-ESR input capacitors in parallel to minimize input-voltage ripple, to reduce ESR-related power losses, and to meet the necessary RMS ripple current rating.

With the MAX17021/MAX17082/MAX17482, the controller shares the current between two phases that operate 180° out-of-phase, so the high-side MOSFETs never turn on simultaneously during normal operation. The instantaneous input current of either phase is effectively halved, resulting in reduced input-voltage ripple, ESR power loss, and RMS ripple current (see the *Input Capacitor Selection* section). Therefore, the same performance can be achieved with fewer or less-expensive input capacitors.

+5V Bias Supply (V_{CC} and V_{DD})

The Quick-PWM controller requires an external +5V bias supply in addition to the battery. Typically, this +5V bias supply is the notebook's 95% efficient +5V system supply. Keeping the bias supply external to the IC improves efficiency and eliminates the cost associated with the +5V linear regulator that would otherwise be needed to supply the PWM circuit and gate drivers. If stand-alone capability is needed, the +5V bias supply can be generated with an external linear regulator.

The +5V bias supply must provide V_{CC} (PWM controller) and V_{DD} (gate-drive power), so the maximum current drawn is:

$$I_{BIAS} = I_{CC} + f_{SW} (Q_{G(Low)} + Q_{G(High)})$$

where I_{CC} is provided in the *Electrical Characteristics* table, f_{SW} is the switching frequency, and Q_{G(Low)} and Q_{G(High)} are the MOSFET data sheet's total gate-charge specification limits at V_{GS} = 5V.

V_{IN} and V_{DD} can be tied together if the input power source is a fixed +4.5V to +5.5V supply. If the +5V bias supply is powered-up prior to the battery supply, the

enable signal (\overline{SHDN} going from low to high) must be delayed until the battery voltage is present to ensure startup.

Switching Frequency (TON)

Connect a resistor (R_{TON}) between TON and V_{IN} to set the switching period T_{SW} = 1/f_{SW}, per phase:

$$T_{SW} = 16.3pF \times (R_{TON} + 6.5k\Omega)$$

A 96.75kΩ to 303.25kΩ corresponds to switching periods of 167ns (600kHz) to 500ns (200kHz), respectively. High-frequency (600kHz) operation optimizes the application for the smallest component size, trading off efficiency due to higher switching losses. This might be acceptable in ultra-portable devices where the load currents are lower and the controller is powered from a lower voltage supply. Low-frequency (200kHz) operation offers the best overall efficiency at the expense of component size and board space.

TON Open-Circuit Protection

The TON input includes open-circuit protection to avoid long, uncontrolled on-times that could result in an over-voltage condition on the output. The MAX17021/MAX17082/MAX17482 detect an open-circuit fault if the TON current drops below 10μA for any reason—the TON resistor (R_{TON}) is unpopulated, a high resistance value is used, the input voltage is low, etc. Under these conditions, the MAX17021/MAX17082/MAX17482 stop switching (DH₋ and DL₋ pulled low) and immediately set the fault latch. Toggle SHDN or cycle the V_{CC} power supply below 0.5V to clear the fault latch and reactivate the controller.

On-Time One-Shot

The core of each phase contains a fast, low-jitter, adjustable one-shot that sets the high-side MOSFETs on-time. The one-shot for the main phase varies the on-time in response to the input and feedback voltages. The main high-side switch on-time is inversely proportional to the input voltage as measured by the TON input, and proportional to the feedback voltage (V_{FB}):

$$t_{ON(MAIN)} = \frac{T_{SW} (V_{FB} + 0.075V)}{V_{IN}}$$

where the switching period (T_{SW} = 1/f_{SW}) is set by the resistor at the TON pin, and 0.075V is an approximation to accommodate the expected drop across the low-side MOSFET switch.

The one-shot for the secondary phase varies the on-time in response to the input voltage and the difference between the main and secondary inductor currents. Two identical transconductance amplifiers integrate the

Dual-Phase, Quick-PWM Controllers for IMVP-6+/IMVP-6.5 CPU Core Power Supplies

difference between the master and slave current-sense signals. The summed output is internally connected to CCI, allowing adjustment of the integration time constant with a compensation network connected between CCI and FB. The resulting compensation current and voltage are determined by the following equations:

$$I_{CCI} = G_m(V_{CSP1} - V_{CSN1}) - G_m(V_{CSP2} - V_{CSN2})$$

$$V_{CCI} = V_{FB} + I_{CCI}Z_{CCI}$$

where Z_{CCI} is the impedance at the CCI output. The secondary on-time one-shot uses this integrated signal (V_{CCI}) to set the secondary high-side MOSFETs on-time. When the main and secondary current-sense signals ($V_{CM} = V_{CSP1} - V_{CSN1}$ and $V_{CS} = V_{CSP2} - V_{CSN2}$) become unbalanced, the transconductance amplifiers adjust the secondary on-time, which increases or decreases the secondary inductor current until the current-sense signals are properly balanced:

$$t_{ON(SEC)} = T_{SW} \left(\frac{V_{CCI} + 0.075V}{V_{IN}} \right)$$

$$= T_{SW} \left(\frac{V_{FB} + 0.075V}{V_{IN}} \right) + T_{SW} \left(\frac{I_{CCI}Z_{CCI}}{V_{IN}} \right)$$

$$= (\text{Main On-time}) + (\text{Secondary Current Balance Correction})$$

This algorithm results in a nearly constant switching frequency and balanced inductor currents despite the lack of a fixed-frequency clock generator. The benefits of a constant switching frequency are twofold: first, the frequency can be selected to avoid noise-sensitive regions such as the 455kHz IF band; second, the inductor ripple-current operating point remains relatively constant, resulting in easy design methodology and predictable output-voltage ripple. The on-time one-shots have good accuracy at the operating points specified in the *Electrical Characteristics* table. On-times at operating points far removed from the conditions specified in the *Electrical Characteristics* table can vary over a wider range.

On-times translate only roughly to switching frequencies. The on-times guaranteed in the *Electrical Characteristics* table are influenced by switching delays in the external high-side MOSFET. Resistive losses, including the inductor, both MOSFETs, output capacitor ESR, and PCB copper losses in the output and ground tend to raise the switching frequency at higher output currents. Also, the dead-time effect increases the effective on-time, reducing the switching frequency. It occurs only during forced-PWM operation and dynamic output-voltage transitions when the induc-

tor current reverses at light- or negative-load currents. With reversed inductor current, the inductor's EMF causes LX_{-} to go high earlier than normal, extending the on-time by a period equal to the DH_{-} -rising dead time. For loads above the critical conduction point, where the dead-time effect is no longer a factor, the actual switching frequency (per phase) is:

$$f_{SW} = \frac{(V_{OUT} + V_{DIS})}{t_{ON}(V_{IN} + V_{DIS} - V_{CHG})}$$

where V_{DIS} is the sum of the parasitic voltage drops in the inductor discharge path, including synchronous rectifier, inductor, and PCB resistances; V_{CHG} is the sum of the parasitic voltage drops in the inductor charge path, including high-side switch, inductor, and PCB resistances; and t_{ON} is the on-time as determined above.

Current Sense

The output current of each phase is sensed. Low-offset amplifiers are used for current balance, voltage-positioning gain, and current limit. Sensing the current at the output of each phase offers advantages, including less noise sensitivity, more accurate current sharing between phases, and the flexibility of using either a current-sense resistor or the DC resistance of the output inductor.

Using the DC resistance (R_{DCR}) of the output inductor allows higher efficiency. In this configuration, the initial tolerance and temperature coefficient of the inductor's DCR must be accounted for in the output-voltage droop-error budget and power monitor. This current-sense method uses an RC filtering network to extract the current information from the output inductor (see Figure 4). The resistive divider used should provide a current-sense resistance (R_{CS}) low enough to meet the current-limit requirements, and the time constant of the RC network should match the inductor's time constant (L/R_{CS}):

$$R_{CS} = \left(\frac{R_2}{R_1 + R_2} \right) R_{DCR}$$

and:

$$R_{CS} = \frac{L}{C_{EQ}} \left[\frac{1}{R_1} + \frac{1}{R_2} \right]$$

where R_{CS} is the required current-sense resistance and R_{DCR} is the inductor's series DC resistance.

Dual-Phase, Quick-PWM Controllers for IMVP-6+/IMVP-6.5 CPU Core Power Supplies

Use the worst-case inductance and R_{DCR} values provided by the inductor manufacturer, adding some margin for the inductance drop over temperature and load. To minimize the current-sense error due to the current-sense inputs' bias current ($I_{CSP_}$ and $I_{CSN_}$), choose $R1/R2$ to be less than $2k\Omega$ and use the previous equation to determine the sense capacitance (C_{EQ}). Choose capacitors with 5% tolerance and resistors with 1% tolerance specifications. Temperature compensation is recommended for this current-sense method. See the *Voltage Positioning and Loop Compensation* section for detailed information.

When using a current-sense resistor for accurate output-voltage positioning, the circuit requires a differential RC filter to eliminate the AC voltage step caused by the equivalent series inductance (L_{ESL}) of the current-sense

resistor (see Figure 4). The ESL induced-voltage step does not affect the average current-sense voltage, but results in a significant peak current-sense voltage error that results in unwanted offsets in the regulation voltage and results in early current-limit detection. Similar to the inductor DCR sensing method above, the RC filter's time constant should match the L/R time constant formed by the current-sense resistor's parasitic inductance:

$$\frac{L_{ESL}}{R_{SENSE}} = C_{EQ}R1$$

where L_{ESL} is the equivalent series inductance of the current-sense resistor, R_{SENSE} is current-sense resistance value, and C_{EQ} and $R1$ are the time-constant matching components.

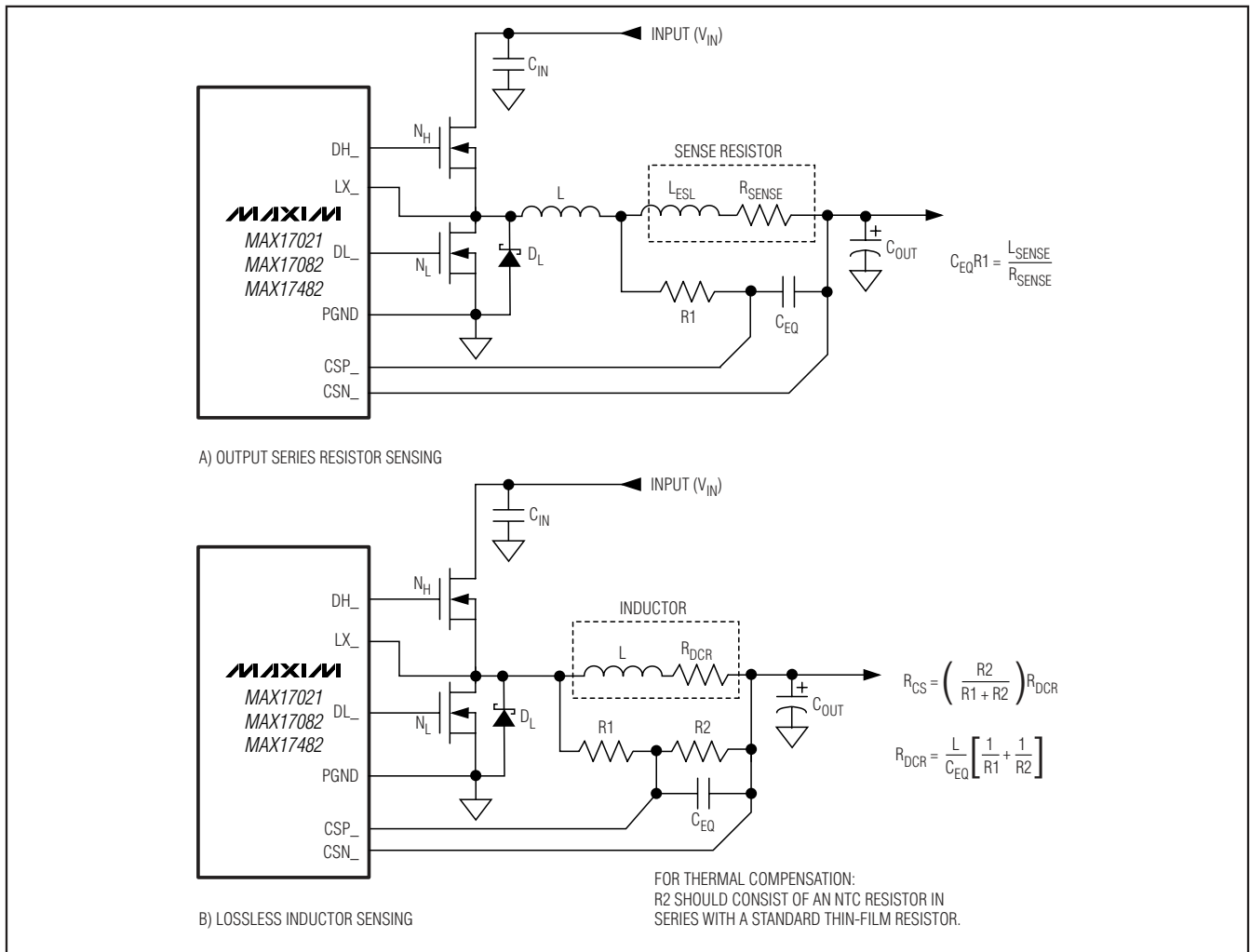

Figure 4. Current-Sense Methods

Dual-Phase, Quick-PWM Controllers for IMVP-6+/IMVP-6.5 CPU Core Power Supplies

Current Balance

The MAX17021/MAX17082/MAX17482 integrate the difference between the current-sense voltages and adjust the on-time of the secondary phase to maintain current balance. The current balance now relies on the accuracy of the current-sense resistors instead of the inaccurate, thermally sensitive on-resistance of the low-side MOSFETs. With active current balancing, the current mismatch is determined by the current-sense resistor values and the offset voltage of the transconductance amplifiers:

$$I_{OS(IBAL)} = I_{LMAIN} - I_{LSEC} = \frac{V_{OS(IBAL)}}{R_{SENSE}}$$

where R_{SENSE} is the effective sense resistance seen at the current-sense pins and $V_{OS(IBAL)}$ is the current-balance offset specification in the *Electrical Characteristics* table.

The worst-case current mismatch occurs immediately after a load transient due to inductor value mismatches resulting in different di/dt for the two phases. The time it takes the current-balance loop to correct the transient imbalance depends on the mismatch between the inductor values and switching frequency.

Current Limit

The current-limit circuit employs a unique “valley” current-sensing algorithm that uses current-sense resistors between the current-sense inputs (CSP_ to CSN_) as the current-sensing elements. If the current-sense signal of the selected phase is above the current-limit threshold, the PWM controller does not initiate a new cycle until the inductor current of the selected phase drops below the valley current-limit threshold. When either phase trips the current limit, both phases are effectively current limited since the interleaved controller does not initiate a cycle with either phase.

Since only the valley current is actively limited, the actual peak current is greater than the current-limit threshold by an amount equal to the inductor ripple current. Therefore, the exact current-limit characteristic and maximum load capability are a function of the current-sense resistance, inductor value, and battery voltage. When combined with the undervoltage-protection cir-

cuit, this current-limit method is effective in almost every circumstance.

The positive valley current-limit threshold voltage at CSP_ to CSN_ equals precisely 1/10 of the differential TIME to ILIM voltage over a 0.1V to 0.5V range (10mV to 50mV current-sense range). Connect ILIM directly to VCC to set the default current-limit threshold setting of 22.5mV (typ).

The negative current-limit threshold (forced-PWM mode only) is nominally -125% of the corresponding valley current-limit threshold. When the inductor current drops below the negative current limit, the controller immediately activates an on-time pulse—DL_ turns off, and DH_ turns on—allowing the inductor current to remain above the negative-current threshold.

Carefully observe the PCB layout guidelines to ensure that noise and DC errors do not corrupt the current-sense signals seen by the current-sense inputs (CSP_, CSN_).

Feedback Adjustment Amplifiers

Voltage-Positioning Amplifier (Steady-State Droop)

The MAX17021/MAX17082/MAX17482 include a transconductance amplifier for adding gain to the voltage-positioning sense path. The amplifier’s input is generated by summing the current-sense inputs, which differentially sense the voltage across either current-sense resistors or the inductor’s DCR. The amplifier’s output connects directly to the regulator’s voltage-positioned feedback input (FB), so the resistance between FB and the output-voltage sense point determines the voltage-positioning gain:

$$V_{OUT} = V_{TARGET} - R_{FB}I_{FB}$$

where the target voltage (V_{TARGET}) is defined in the *Nominal Output-Voltage Selection* section, and the FB amplifier’s output current (I_{FB}) is determined by the sum of the current-sense voltages:

$$I_{FB} = G_{m(FB)} \sum_{X=1}^{N_{PH}} V_{CSX}$$

where $V_{CS} = V_{CSP_} - V_{CSN_}$ is the differential current-sense voltage, and $G_{m(FB)}$ is typically 600 μ S as defined in the *Electrical Characteristics* table.

Dual-Phase, Quick-PWM Controllers for IMVP-6+/IMVP-6.5 CPU Core Power Supplies

Differential Remote Sense

The MAX17021/MAX17082/MAX17482 include differential, remote-sense inputs to eliminate the effects of voltage drops along the PCB traces and through the processor's power pins. The feedback-sense node connects to the voltage-positioning resistor (R_{FB}). The ground-sense (GNDS) input connects to an amplifier that adds an offset directly to the target voltage, effectively adjusting the output voltage to counteract the voltage drop in the ground path. Connect the voltage-positioning resistor (R_{FB}), and ground-sense (GNDS) input directly to the processor's remote-sense outputs, as shown in Figure 1.

Integrator Amplifier

An integrator amplifier forces the DC average of the FB voltage to equal the target voltage. This transconductance amplifier integrates the feedback voltage and provides a fine adjustment to the regulation voltage (Figure 3), allowing accurate DC output-voltage regulation regardless of the output ripple voltage. The integrator amplifier has the ability to shift the output voltage by $\pm 100\text{mV}$ (typ). The differential input-voltage range is at least $\pm 60\text{mV}$ total, including DC offset and AC ripple.

The MAX17021/MAX17082/MAX17482 disable the integrator by connecting the amplifier inputs together at the beginning of all VID transitions done in pulse-skipping mode (DPRSLPVR = high). The integrator remains disabled until $20\mu\text{s}$ after the transition is completed (the internal target settles) and the output is in regulation (edge detected on the error comparator).

Transient-Overlap Operation

When a transient occurs, the response time of the controller depends on how quickly it can slew the inductor current. Multiphase controllers that remain 180° out-of-phase when a transient occurs actually respond slower than an equivalent single-phase controller. To provide fast-transient response, the MAX17021/MAX17082/MAX17482 support a phase-overlap mode, which allows the dual regulators to operate in-phase when heavy load transients are detected, effectively reducing

the response time. After either high-side MOSFET turns off, if the output voltage does not exceed the regulation voltage when the minimum off-time expires, the controller simultaneously turns on both high-side MOSFETs during the next on-time cycle. This maximizes the total inductor current slew rate. The phases remain overlapped until the output voltage exceeds the regulation voltage after the minimum off-time expires.

After the phase-overlap mode ends, the controller automatically begins with the opposite phase. For example, if the secondary phase provided the last on-time pulse before overlap operation began, the controller starts switching with the main phase when overlap operation ends. Table 3 is the operating mode truth table.

Nominal Output-Voltage Selection

The nominal no-load output voltage (V_{TARGET}) is defined by the selected voltage reference (V_{DAC}) plus the remote ground-sense adjustment (V_{GNDS}) as defined in the following equation:

$$V_{TARGET} = V_{FB} = V_{DAC} + V_{GNDS}$$

where V_{DAC} is the selected VID voltage. On startup, the MAX17021/MAX17082/MAX17482 slew the target voltage from ground to the preset boot voltage.

DAC Inputs (D0–D6)

The digital-to-analog converter (DAC) programs the output voltage using the D0–D6 inputs. D0–D6 are low-voltage (1.0V) logic inputs, designed to interface directly with the CPU. Do not leave D0–D6 unconnected. Changing D0–D6 initiates a transition to a new output-voltage level. Change D0–D6 together, avoiding greater than 20ns skew between bits. Otherwise, incorrect DAC readings might cause a partial transition to the wrong voltage level followed by the intended transition to the correct voltage level, lengthening the overall transition time. The available DAC codes and resulting output voltages are compatible with the IMVP-6/IMVP-6+ and IMVP-6.5 (Table 4) specifications.

Dual-Phase, Quick-PWM Controllers for IMVP-6+/IMVP-6.5 CPU Core Power Supplies

MAX17021/MAX17082/MAX17482

Table 3. Operating Mode Truth Table

INPUTS				PHASE OPERATION*	OPERATING MODE
$\overline{\text{SHDN}}$	$\overline{\text{DPRSTP}}$ (SLOW)	DPRSLPVR	$\overline{\text{PSI}}$		
GND	X	X	X	Disabled	Low-Power Shutdown Mode. DL1 and DL2 forced low, and the controller is disabled. The supply current drops to 1 μ A (max).
Rising	X	X	X	Multiphase pulse-skipping 1/8 R _{TIME} slew rate	Startup/Boot. When $\overline{\text{SHDN}}$ is pulled high, the MAX17021/MAX17082/MAX17482 begin the startup sequence. The controller enables the PWM regulator and ramps the output voltage up to the boot voltage. See Figure 10.
High	X (High)	Low	High	Multiphase forced-PWM nominal R _{TIME} slew rate	Full Power. The no-load output voltage is determined by the selected VID DAC code (D0–D6, Table 4).
High	X (High)	Low	Low	1-phase forced-PWM nominal R _{TIME} slew rate	Intermediate Power. The no-load output voltage is determined by the selected VID DAC code (D0–D6, Table 4). When $\overline{\text{PSI}}$ is pulled low, the MAX17021/MAX17082/MAX17482 immediately disable phase 2. DH2 and DL2 are pulled low.
High	Low (High)	High	X	1-phase pulse-skipping nominal R _{TIME} slew rate	Deeper Sleep Mode. The no-load output voltage is determined by the selected VID DAC code (D0–D6, Table 4). When DPRSLPVR is pulled high, the MAX17021/MAX17082/MAX17482 immediately enter one-phase pulse-skipping operation, allowing automatic PWM/PFM switchover under light loads. The PWRGD and $\overline{\text{CLKEN}}$ upper thresholds are blanked during downward transitions. DH2 and DL2 are pulled low.
High	High (Low)	High	X	1-phase pulse-skipping	Deeper Sleep Slow Exit Mode. The no-load output voltage is determined by the selected VID DAC code (D0–D6, Table 4). When $\overline{\text{DPRSTP}}$ is pulled high while DPRSLPVR is already high, the MAX17021 remains in one-phase pulse-skipping operation, allowing automatic PWM/PFM switchover under light loads, but reduces its slew rate to 1/4 of normal. When SLOW is pulled low, the MAX17082/MAX17482 reduce their slew rate to 1/2 of normal. The PWRGD and $\overline{\text{CLKEN}}$ upper thresholds are blanked. DH2 and DL2 are pulled low.
Falling	X	X	X	Multiphase forced-PWM 1/8 R _{TIME} slew rate	Shutdown. When $\overline{\text{SHDN}}$ is pulled low, the MAX17021/MAX17082/MAX17482 immediately pull PWRGD and PHASEGD low, $\overline{\text{CLKEN}}$ becomes high, all enabled phases are activated, and the output voltage is ramped down to ground. Once the output reaches 0V, the controller enters the low-power shutdown state. See Figure 10.
High	X	X	X	Disabled	Fault Mode. The fault latch has been set by the MAX17021/MAX17082/MAX17482 UVP or thermal-shutdown protection, or by the OVP protection. The controller remains in fault mode until VCC power is cycled or $\overline{\text{SHDN}}$ toggled.

*Multiphase operation—all enabled phases active.

Dual-Phase, Quick-PWM Controllers for IMVP-6+/IMVP-6.5 CPU Core Power Supplies

Table 4. IMVP-6+/IMVP-6.5 Output-Voltage VID DAC Codes

D6	D5	D4	D3	D2	D1	D0	OUTPUT VOLTAGE (V)	D6	D5	D4	D3	D2	D1	D0	OUTPUT VOLTAGE (V)
0	0	0	0	0	0	0	1.5000	1	0	0	0	0	0	0	0.7000
0	0	0	0	0	0	1	1.4875	1	0	0	0	0	0	1	0.6875
0	0	0	0	0	1	0	1.4750	1	0	0	0	0	1	0	0.6750
0	0	0	0	0	1	1	1.4625	1	0	0	0	0	1	1	0.6625
0	0	0	0	1	0	0	1.4500	1	0	0	0	1	0	0	0.6500
0	0	0	0	1	0	1	1.4375	1	0	0	0	1	0	1	0.6375
0	0	0	0	1	1	0	1.4250	1	0	0	0	1	1	0	0.6250
0	0	0	0	1	1	1	1.4125	1	0	0	0	1	1	1	0.6125
0	0	0	1	0	0	0	1.4000	1	0	0	1	0	0	0	0.6000
0	0	0	1	0	0	1	1.3875	1	0	0	1	0	0	1	0.5875
0	0	0	1	0	1	0	1.3750	1	0	0	1	0	1	0	0.5750
0	0	0	1	0	1	1	1.3625	1	0	0	1	0	1	1	0.5625
0	0	0	1	1	0	0	1.3500	1	0	0	1	1	0	0	0.5500
0	0	0	1	1	0	1	1.3375	1	0	0	1	1	0	1	0.5375
0	0	0	1	1	1	0	1.3250	1	0	0	1	1	1	0	0.5250
0	0	0	1	1	1	1	1.3125	1	0	0	1	1	1	1	0.5125
0	0	1	0	0	0	0	1.3000	1	0	1	0	0	0	0	0.5000
0	0	1	0	0	0	1	1.2875	1	0	1	0	0	0	1	0.4875
0	0	1	0	0	1	0	1.2750	1	0	1	0	0	1	0	0.4750
0	0	1	0	0	1	1	1.2625	1	0	1	0	0	1	1	0.4625
0	0	1	0	1	0	0	1.2500	1	0	1	0	1	0	0	0.4500
0	0	1	0	1	0	1	1.2375	1	0	1	0	1	0	1	0.4375
0	0	1	0	1	1	0	1.2250	1	0	1	0	1	1	0	0.4250
0	0	1	0	1	1	1	1.2125	1	0	1	0	1	1	1	0.4125
0	0	1	1	0	0	0	1.2000	1	0	1	1	0	0	0	0.4000
0	0	1	1	0	0	1	1.1875	1	0	1	1	0	0	1	0.3875
0	0	1	1	0	1	0	1.1750	1	0	1	1	0	1	0	0.3750
0	0	1	1	0	1	1	1.1625	1	0	1	1	0	1	1	0.3625
0	0	1	1	1	0	0	1.1500	1	0	1	1	1	0	0	0.3500
0	0	1	1	1	0	1	1.1375	1	0	1	1	1	0	1	0.3375
0	0	1	1	1	1	0	1.1250	1	0	1	1	1	1	0	0.3250
0	0	1	1	1	1	1	1.1125	1	0	1	1	1	1	1	0.3125
0	0	1	1	1	1	1	1.1125	1	0	1	1	1	1	1	0.3125

Dual-Phase, Quick-PWM Controllers for IMVP-6+/IMVP-6.5 CPU Core Power Supplies

MAX17021/MAX17082/MAX17482

Table 4. IMVP-6+/IMVP-6.5 Output-Voltage VID DAC Codes (continued)

D6	D5	D4	D3	D2	D1	D0	OUTPUT VOLTAGE (V)	D6	D5	D4	D3	D2	D1	D0	OUTPUT VOLTAGE (V)
0	1	0	0	0	0	0	1.1000	1	1	0	0	0	0	0	0.3000
0	1	0	0	0	0	1	1.0875	1	1	0	0	0	0	1	0.2875
0	1	0	0	0	1	0	1.0750	1	1	0	0	0	1	0	0.2750
0	1	0	0	0	1	1	1.0625	1	1	0	0	0	1	1	0.2625
0	1	0	0	1	0	0	1.0500	1	1	0	0	1	0	0	0.2500
0	1	0	0	1	0	1	1.0375	1	1	0	0	1	0	1	0.2375
0	1	0	0	1	1	0	1.0250	1	1	0	0	1	1	0	0.2250
0	1	0	0	1	1	1	1.0125	1	1	0	0	1	1	1	0.2125
0	1	0	1	0	0	0	1.0000	1	1	0	1	0	0	0	0.2000
0	1	0	1	0	0	1	0.9875	1	1	0	1	0	0	1	0.1875
0	1	0	1	0	1	0	0.9750	1	1	0	1	0	1	0	0.1750
0	1	0	1	0	1	1	0.9625	1	1	0	1	0	1	1	0.1625
0	1	0	1	1	0	0	0.9500	1	1	0	1	1	0	0	0.1500
0	1	0	1	1	0	1	0.9375	1	1	0	1	1	0	1	0.1375
0	1	0	1	1	1	0	0.9250	1	1	0	1	1	1	0	0.1250
0	1	0	1	1	1	1	0.9125	1	1	0	1	1	1	1	0.1125
0	1	1	0	0	0	0	0.9000	1	1	1	0	0	0	0	0.1000
0	1	1	0	0	0	1	0.8875	1	1	1	0	0	0	1	0.0875
0	1	1	0	0	1	0	0.8750	1	1	1	0	0	1	0	0.0750
0	1	1	0	0	1	1	0.8625	1	1	1	0	0	1	1	0.0625
0	1	1	0	1	0	0	0.8500	1	1	1	0	1	0	0	0.0500
0	1	1	0	1	0	1	0.8375	1	1	1	0	1	0	1	0.0375
0	1	1	0	1	1	0	0.8250	1	1	1	0	1	1	0	0.0250
0	1	1	0	1	1	1	0.8125	1	1	1	0	1	1	1	0.0125
0	1	1	1	0	0	0	0.8000	1	1	1	1	0	0	0	0
0	1	1	1	0	0	1	0.7875	1	1	1	1	0	0	1	0
0	1	1	1	0	1	0	0.7750	1	1	1	1	0	1	0	0
0	1	1	1	0	1	1	0.7625	1	1	1	1	0	1	1	0
0	1	1	1	1	0	0	0.7500	1	1	1	1	1	0	0	0
0	1	1	1	1	0	1	0.7375	1	1	1	1	1	0	1	0
0	1	1	1	1	1	0	0.7250	1	1	1	1	1	1	0	0
0	1	1	1	1	1	1	0.7125	1	1	1	1	1	1	1	0

*D6–D0 = 111111 is an OFF code for the MAX17082/MAX17482. The MAX17082/MAX17482 enter the shutdown sequence if the OFF code is set, forcing PWRGD and PHASEGD low, and forcing CLKEN high. Exit from the OFF code follows the startup sequence. If the OFF code is present when SHDN is pulled high, the MAX17082/MAX17482 remain off.

Dual-Phase, Quick-PWM Controllers for IMVP-6+/IMVP-6.5 CPU Core Power Supplies

Suspend Mode

When the processor enters low-power deeper sleep mode, the IMVP-6 CPU sets the VID DAC code to a lower output voltage and drives DPRSLPVR high. The MAX17021/MAX17082/MAX17482 respond by slewing the internal target voltage to the new DAC code, switching to single-phase operation, and letting the output voltage gradually drift down to the deeper sleep voltage. During the transition, the MAX17021/MAX17082/MAX17482 blank both the upper and lower PWRGD and $\overline{\text{CLKEN}}$ thresholds until 20 μs after the internal target reaches the deeper sleep voltage. Once the 20 μs timer expires, the MAX17021/MAX17082/MAX17482 reenables the lower PWRGD and $\overline{\text{CLKEN}}$ threshold, but keep the upper threshold blanked until the output voltage reaches the regulation level. PHASEGD remains blanked high impedance while DPRSLPVR is high.

Output-Voltage-Transition Timing

The MAX17021/MAX17082/MAX17482 perform mode transitions in a controlled manner, automatically minimizing input surge currents. This feature allows the circuit designer to achieve nearly ideal transitions, guaranteeing just-in-time arrival at the new output-voltage level with the lowest possible peak currents for a given output capacitance.

At the beginning of an output-voltage transition, the MAX17021/MAX17082/MAX17482 blank both PWRGD thresholds, preventing the PWRGD open-drain output from changing states during the transition. The controller enables the lower PWRGD threshold approximately 20 μs after the slew-rate controller reaches the target output voltage, but the upper PWRGD threshold remains blanked until the output voltage reaches the regulation level if the controller enters pulse-skipping operation. The slew rate (set by resistor R_{TIME}) must be set fast enough to ensure that the transition can be completed within the maximum allotted time.

The MAX17021/MAX17082/MAX17482 automatically control the current to the minimum level required to complete the transition in the calculated time. The slew-rate controller uses an internal capacitor and current source programmed by R_{TIME} to transition the output voltage. The total transition time depends on R_{TIME} , the voltage difference, and the accuracy of the slew-rate controller (C_{SLEW} accuracy). The slew rate is not dependent on the total output capacitance, as long as the surge current is less than the current limit. For all

dynamic VID transitions, the transition time (t_{TRAN}) is given by:

$$t_{\text{TRAN}} = \frac{|V_{\text{NEW}} - V_{\text{OLD}}|}{(dV_{\text{TARGET}}/dt)}$$

where $dV_{\text{TARGET}}/dt = 12.5\text{mV}/\mu\text{s} \times 71.5\text{k}\Omega/R_{\text{TIME}}$ is the slew rate, V_{OLD} is the original output voltage, and V_{NEW} is the new target voltage. See TIME Slew Rate Accuracy in *Electrical Characteristics* for slew-rate limits. For soft-start and shutdown, the controller automatically reduces the slew rate to 1/8.

The output voltage tracks the slewed target voltage, making the transitions relatively smooth. The average inductor current per phase required to make an output-voltage transition is:

$$I_L \cong \frac{C_{\text{OUT}}}{\eta_{\text{TOTAL}}} \times (dV_{\text{TARGET}}/dt)$$

where dV_{TARGET}/dt is the required slew rate, C_{OUT} is the total output capacitance, and η_{TOTAL} is the number of active phases.

Deeper Sleep Transitions

When DPRSLPVR goes high, the MAX17021/MAX17082/MAX17482 immediately disable phase 2 (DH2 and DL2 forced low), blank PHASEGD high impedance, and enter pulse-skipping operation (see Figures 5 and 6). If the VIDs are set to a lower voltage setting, the output drops at a rate determined by the load and the output capacitance. The internal target still ramps as before, and PWRGD remains blanked high impedance until 20 μs after the output voltage reaches the internal target.

- **Fast C4E Deeper Sleep Exit:** When exiting deeper sleep (DPRSLPVR pulled low) while the output voltage still exceeds the deeper sleep voltage, the MAX17021/MAX17082/MAX17482 quickly slew (50mV/ μs min regardless of R_{TIME} setting) the internal target voltage to the DAC code provided by the processor as long as the output voltage is above the new target. The controller remains in skip mode until the output voltage equals the internal target. Once the internal target reaches the output voltage, phase 2 is enabled. The controller blanks PWRGD, PHASEGD, and $\overline{\text{CLKEN}}$ until 20 μs after the transition is completed. See Figure 5.

Dual-Phase, Quick-PWM Controllers for IMVP-6+/IMVP-6.5 CPU Core Power Supplies

- Standard C4 Deeper Sleep Exit:** When exiting deeper sleep (DPRSLPVR pulled low) while the output voltage is regulating to the deeper sleep voltage, the MAX17021/MAX17082/MAX17482 immediately activate all enabled phases and ramp the output voltage to the LFM DAC code provided by the processor at the slew rate set by RTIME. The controller blanks PWRGD, PHASEGD, and CLKEN until 20µs after the transition is completed. See Figure 6.
- IMVP-6+ Slow C4 Deeper Sleep Exit:** When exiting deeper sleep (DPRSLPVR high, DPRSTP pulled high) while the output voltage is regulating to the deeper sleep voltage, the MAX17021 remains in 1-phase skip mode and ramps the output voltage to the LFM DAC code provided by the processor at 1/4 the slew rate set by RTIME. The controller blanks PWRGD, PHASEGD, and CLKEN until 20µs after the transition is completed. See Figure 7.

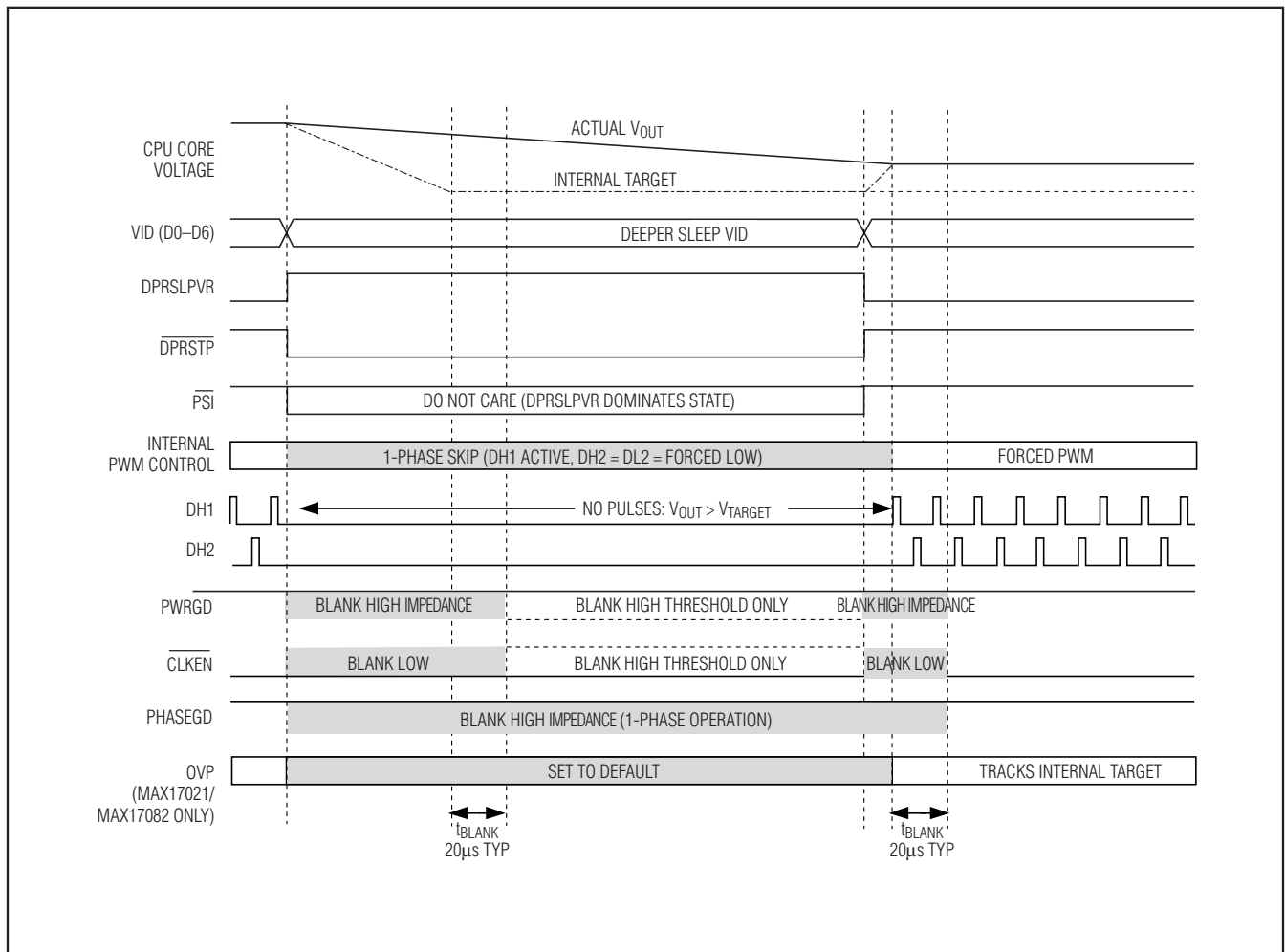

Figure 5. C4E (C4 Early Exit) Transition

Dual-Phase, Quick-PWM Controllers for IMVP-6+/IMVP-6.5 CPU Core Power Supplies

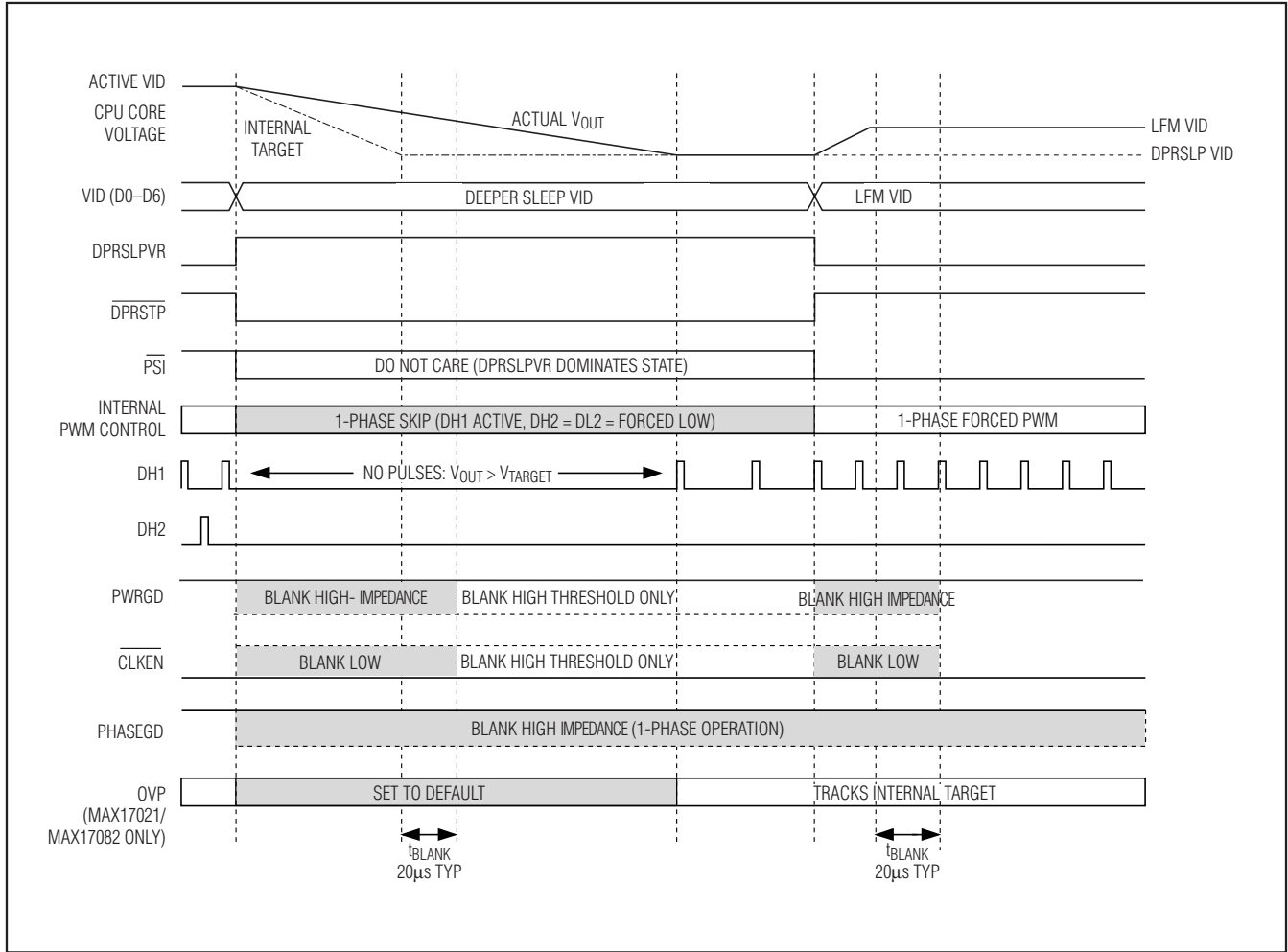

Figure 6. Standard C4 Transition

Dual-Phase, Quick-PWM Controllers for IMVP-6+/IMVP-6.5 CPU Core Power Supplies

MAX17021/MAX17082/MAX17482

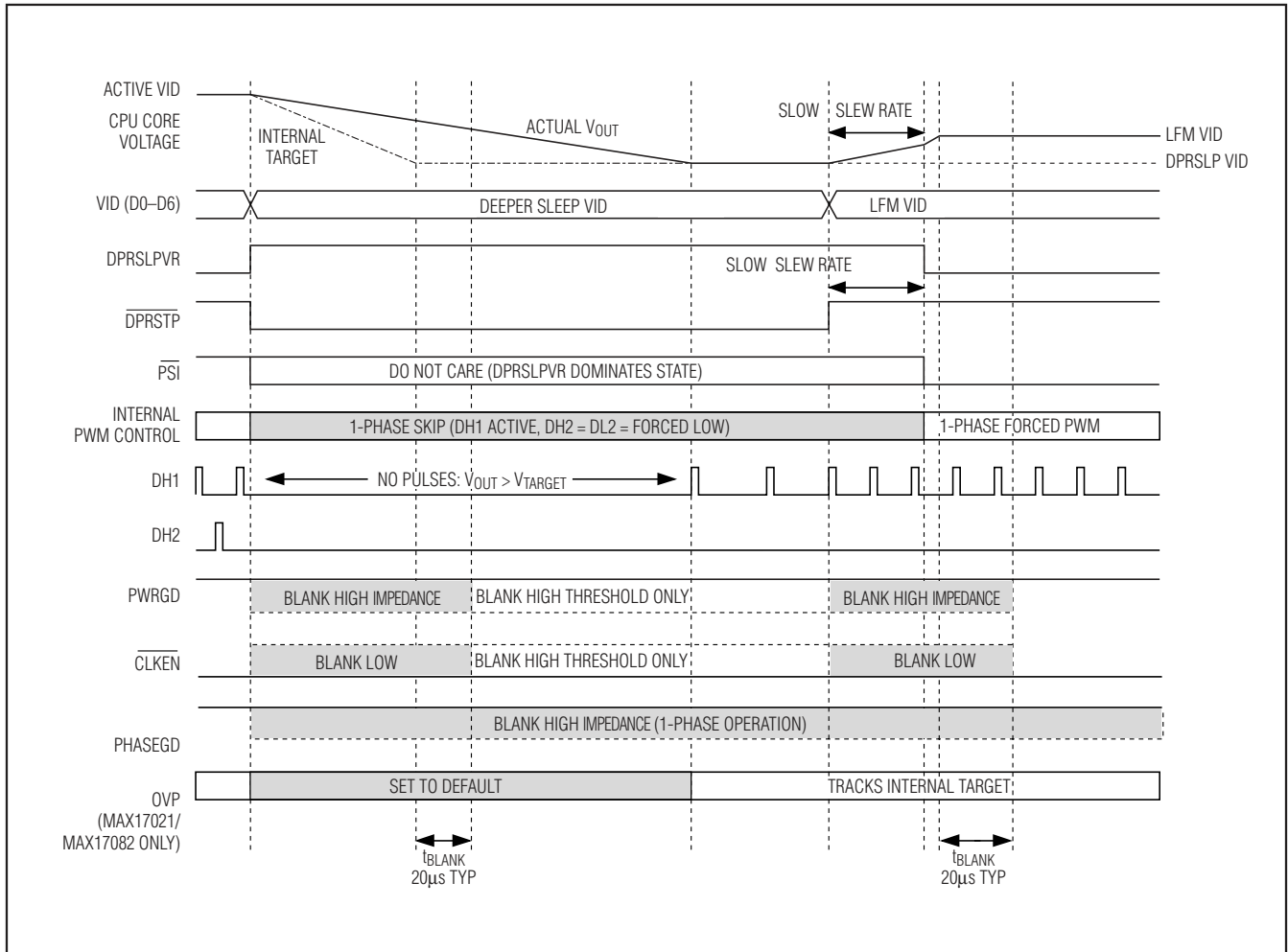

Figure 7. Slow C4 Transition

Dual-Phase, Quick-PWM Controllers for IMVP-6+/IMVP-6.5 CPU Core Power Supplies

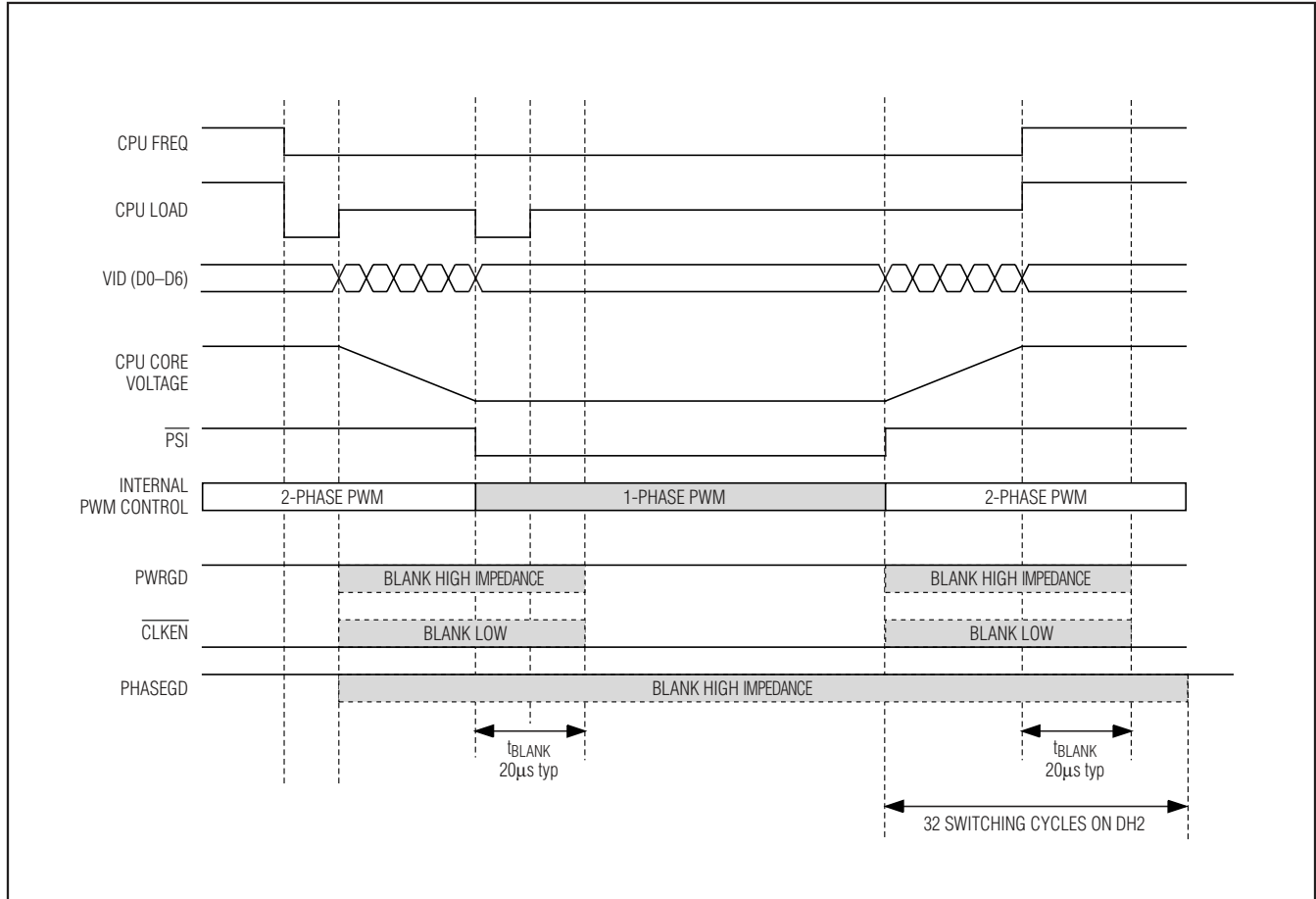

Figure 8. $\overline{\text{PSI}}$ Transition

$\overline{\text{PSI}}$ Transitions

When $\overline{\text{PSI}}$ is pulled low, the MAX17021/MAX17082/MAX17482 immediately disable phase 2 (DH2 and DL2 forced low), blank PHASEGD high impedance, and enter single-phase PWM operation (see Figure 8). When $\overline{\text{PSI}}$ is pulled high, the MAX17021/MAX17082/MAX17482 enable phase 2. PHASEGD is blanked high impedance for 32 switching cycles on DH2, allowing sufficient time/cycles for phases 1 and 2 to achieve current balance. In a typical IMVP-6 application, the VID is reduced by 1 LSB (12.5mV) when $\overline{\text{PSI}}$ is pulled low, and increased by 1 LSB when $\overline{\text{PSI}}$ is pulled high.

Forced-PWM Operation (Normal Mode)

During soft-shutdown, and normal operation—when the CPU is actively running (DPRSLPVR = low)—the MAX17021/MAX17082/MAX17482 operate with the low-noise, forced-PWM control scheme. Forced-PWM operation disables the zero-crossing comparators of all active phases, forcing the low-side gate-drive wave-

forms to constantly be the complement of the high-side gate-drive waveforms. This keeps the switching frequency constant and allows the inductor current to reverse under light loads, providing fast, accurate negative output-voltage transitions by quickly discharging the output capacitors.

Forced-PWM operation comes at a cost: the no-load 5V bias supply current remains between 10mA to 50mA per phase, depending on the external MOSFETs and switching frequency. To maintain high efficiency under light-load conditions, the processor can switch the controller to a low-power pulse-skipping control scheme after entering suspend mode.

$\overline{\text{PSI}}$ determines how many phases are active when operating in forced-PWM mode (DPRSLPVR = low). When $\overline{\text{PSI}}$ is pulled low, the main phase remains active but the secondary phase is disabled (DH2 and DL2 forced low).

Dual-Phase, Quick-PWM Controllers for IMVP-6+/IMVP-6.5 CPU Core Power Supplies

MAX17021/MAX17082/MAX17482

Light-Load Pulse-Skipping Operation (Deeper Sleep)

When DPRSLPVR is pulled high, the MAX17021/MAX17082/MAX17482 operate with a single-phase pulse-skipping mode. The pulse-skipping mode enables the driver's zero-crossing comparator, so the controller pulls DL1 low when it detects zero inductor current. This keeps the inductor from discharging the output capacitors and forces the controller to skip pulses under light-load conditions to avoid overcharging the output.

During downward transitions in pulse-skipping operation, the controller temporarily sets the OVP threshold to default, preventing false OVP faults when the transition to pulse-skipping operation coincides with a VID code change. Once the error amplifier detects that the output voltage is in regulation, the OVP threshold tracks the selected VID DAC code. The MAX17021/MAX17082/MAX17482 automatically use forced-PWM operation during soft-shutdown, regardless of the DPRSLPVR and PSI configuration.

Automatic Pulse-Skipping Switchover

In skip mode (DPRSLPVR = high), an inherent automatic switchover to PFM takes place at light loads (Figure 9). This switchover is affected by a comparator that truncates the low-side switch on-time at the inductor current's zero crossing. The zero-crossing comparator senses the inductor current across the low-side MOSFETs. Once V_{LX} drops below the zero-crossing comparator threshold (see the *Electrical Characteristics* table), the comparator forces DL₁ low. This mechanism causes the threshold between pulse-skipping PFM and nonskipping PWM operation to coincide with the boundary between continuous and discontinuous inductor-current operation. The PFM/PWM crossover occurs when the load current of each phase is equal to 1/2 the peak-to-peak ripple current, which is a function of the inductor value (Figure 9). For a battery input range of 7V to 20V, this threshold is relatively constant, with only a minor dependence on the input voltage due to the typically low duty cycles. The total load current at the PFM/PWM crossover threshold ($I_{LOAD(SKIP)}$) is approximately:

$$I_{LOAD(SKIP)} = \eta_{TOTAL} \left(\frac{T_{SW} V_{OUT}}{L} \right) \left(\frac{V_{IN} - V_{OUT}}{V_{IN}} \right)$$

where η_{TOTAL} is the number of active phases.

The switching waveforms might appear noisy and asynchronous when light loading activates pulse-skipping operation, but this is a normal operating condition that results in high light-load efficiency. Trade-offs between PFM noise and light-load efficiency are made by varying the inductor value. Generally, low inductor values produce a broader efficiency vs. load curve, while higher values result in higher full-load efficiency (assuming that the coil resistance remains fixed) and less output-voltage ripple. Penalties for using higher inductor values include larger physical size and degraded load-transient response, especially at low input-voltage levels.

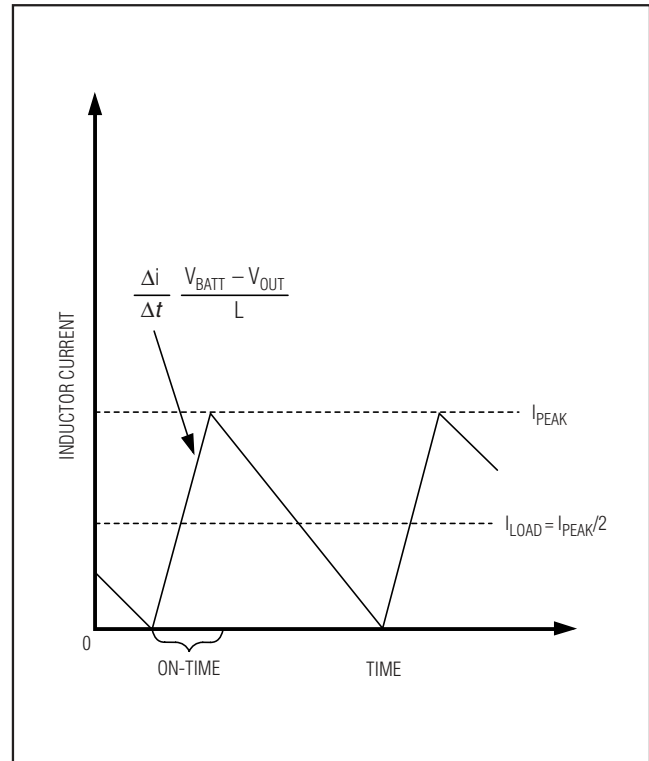

Figure 9. Pulse-Skipping/Discontinuous Crossover Point

Dual-Phase, Quick-PWM Controllers for IMVP-6+/IMVP-6.5 CPU Core Power Supplies

Power-Up Sequence (POR, UVLO)

The MAX17021/MAX17082/MAX17482 are enabled when $\overline{\text{SHDN}}$ is driven high (Figure 10). The internal reference powers up first. Once the reference exceeds its UVLO threshold, the internal analog blocks are turned on and masked by a 50 μs one-shot delay. The PWM controller is then enabled.

Power-on reset (POR) occurs when V_{CC} rises above approximately 2V, resetting the fault latch and preparing the controller for operation. The V_{CC} UVLO circuitry inhibits switching until V_{CC} rises above 4.25V. The controller powers up the reference once the system enables the controller, V_{CC} is above 4.25V, and $\overline{\text{SHDN}}$ is driven high. With the reference in regulation, the controller ramps the output voltage to the boot voltage (1.2V for MAX17021 IMVP-6+ and 1.1V for MAX17082/MAX17482 IMVP-6.5) at 1/8 the slew rate set by R_{TIME} :

$$t_{\text{TRAN(START)}} = \frac{8V_{\text{BOOT}}}{(dV_{\text{TARGET}}/dt)}$$

where $dV_{\text{TARGET}}/dt = 12.5\text{mV}/\mu\text{s} \times 71.5\text{k}\Omega/R_{\text{TIME}}$ is the slew rate. The soft-start circuitry does not use a variable

current limit, so full output current is available immediately. $\overline{\text{CLKEN}}$ is pulled low approximately 60 μs after the MAX17021/MAX17082/MAX17482 reach the boot voltage if PGDIN is high. At the same time, the MAX17021/MAX17082/MAX17482 slew the output to the voltage set at the VID inputs at the programmed slew rate. PWRGD and PHASEGD become high impedance approximately 5ms after $\overline{\text{CLKEN}}$ is pulled low. The MAX17021/MAX17082/MAX17482 automatically use forced-PWM operation during soft-start and soft-shutdown, regardless of the DPRSLPVR and $\overline{\text{PSI}}$ configuration.

For automatic startup, the battery voltage should be present before V_{CC} . If the controller attempts to bring the output into regulation without the battery voltage present, the fault latch trips. The controller remains shut down until the fault latch is cleared by toggling $\overline{\text{SHDN}}$ or cycling the V_{CC} power supply below 0.5V.

If the V_{CC} voltage drops below 4.25V, the controller assumes that there is not enough supply voltage to make valid decisions. To protect the output from over-voltage faults, the controller shuts down immediately and forces a high-impedance output.

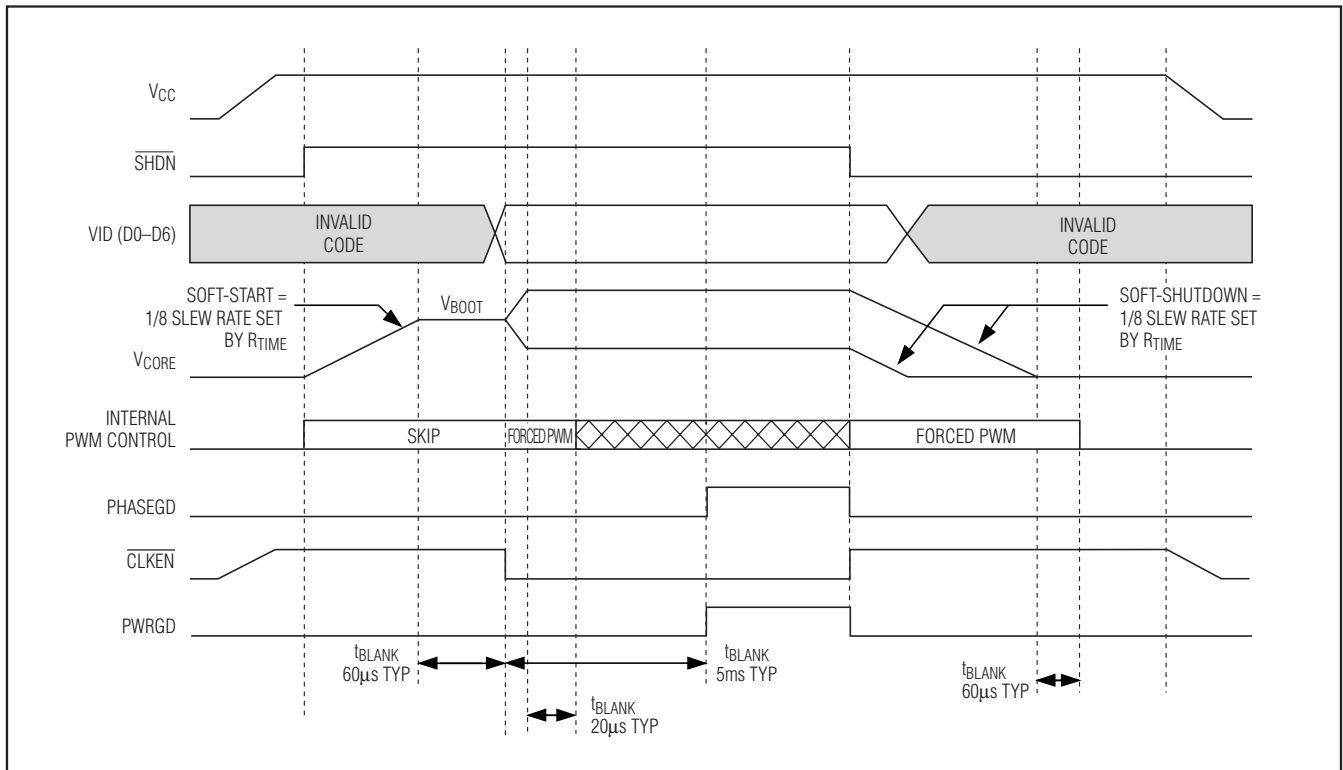

Figure 10. Power-Up and Shutdown Sequence Timing Diagram

Dual-Phase, Quick-PWM Controllers for IMVP-6+/IMVP-6.5 CPU Core Power Supplies

Shutdown

When $\overline{\text{SHDN}}$ goes low, the MAX17021/MAX17082/MAX17482 enter low-power shutdown mode. PWRGD is pulled low immediately, and the output voltage ramps down at 1/8 the slew rate set by R_{TIME} :

$$t_{\text{TRAN(SHDN)}} = \frac{8V_{\text{OUT}}}{(dV_{\text{TARGET}}/dt)}$$

where $dV_{\text{TARGET}}/dt = 12.5\text{mV}/\mu\text{s} \times 71.5\text{k}\Omega/R_{\text{TIME}}$ is the slew rate. Slowly discharging the output capacitors by slewing the output over a long period of time keeps the average negative inductor current low (damped response), thereby eliminating the negative output-voltage excursion that occurs when the controller discharges the output quickly by permanently turning on the low-side MOSFET (underdamped response). This eliminates the need for the Schottky diode normally connected between the output and ground to clamp the negative output-voltage excursion. After the controller reaches the zero target, the MAX17021/MAX17082/MAX17482 shut down completely—the drivers are disabled (DL1 and DL2 driven low) and the supply current drops below $1\mu\text{A}$.

When a fault condition—output UVLO or thermal shutdown—activates the shutdown sequence, the protection circuitry sets the fault latch to prevent the controller from restarting. To clear the fault latch and reactivate the controller, toggle $\overline{\text{SHDN}}$ or cycle V_{CC} power below 0.5V .

Current Monitor (IMON) (MAX17021/MAX17482 Only)

The MAX17082/MAX17482 includes a unidirectional transconductance amplifier that sources current proportional to the positive current-sense voltage. The IMON output current is defined by:

$$I_{\text{IMON}} = G_{\text{m(IMON)}} \times \Sigma(V_{\text{CSP}_-} - V_{\text{CSN}_-})$$

where $G_{\text{m(IMON)}} = 2.4\text{mS}$ (typ) and the IMON current is unidirectional (sources current out of IMON only) for positive current-sense values. For negative current-sense voltages, the IMON current is zero.

The current monitor allows the processor to accurately monitor the CPU load and quickly calculate the power dissipation to determine if the system is about to over-heat before the significantly slower temperature sensor signals an over-temperature alert.

Connect an external resistor between IMON and $V_{\text{SS_SENSE}}$ to create the desired IMON gain based on the following equation:

$$R_{\text{IMON}} = 0.999V / (I_{\text{MAX}} \times R_{\text{SENSE}} \times G_{\text{m(IMON)}})$$

where I_{MAX} is defined in the *Current Monitor* section of the Intel IMVP-6.5 specification and based on discrete

increments (10A, 20A, 30A, 40A, etc.), R_{SENSE} is the **typical** effective value of the current-sense element (sense resistor or inductor DCR) that is used to provide the current-sense voltage, and $G_{\text{m(IMON)}}$ is the **typical** transconductance amplifier gain as defined in the *Electrical Characteristics* table.

The IMON voltage is internally clamped to a maximum of 1.1V (typ), preventing the IMON output from exceeding the IMON voltage rating even under overload or short-circuit conditions. When the controller is disabled, IMON is pulled to ground.

To filter the IMON signal, use an RC filter as shown in Figure 2. The filter time constant is $(R7 + R8) \times C15$.

Phase Fault (PHASEGD)

The MAX17021/MAX17082/MAX17482 include a phase-fault output that signals the system that one of the two phases either has a fault condition or is not matched with the other. Detection is done by identifying the need for a large on-time difference between phases in order to achieve or move towards current balance.

PHASEGD is high impedance when the controller operates in one-phase mode (DPRSLPVR high or $\overline{\text{PSI}}$ low and DPRSLPVR low). On exit to two-phase mode, PHASEGD is forced high impedance for 32 switching cycles on DH2.

PHASEGD is low in shutdown. PHASEGD is forced high impedance whenever the slew-rate controller is active (output-voltage transitions).

Temperature Comparator (VRHOT)

The MAX17021/MAX17082/MAX17482 also feature an independent comparator with an accurate threshold (V_{HOT}) that tracks the analog supply voltage ($V_{\text{HOT}} = 0.3V_{\text{CC}}$). This makes the thermal trip threshold independent of the V_{CC} supply voltage tolerance. Use a resistor- and thermistor-divider between V_{CC} and GND to generate a voltage-regulator over-temperature monitor. Place the thermistor as close to the MOSFETs and inductors as possible.

Fault Protection (Latched) Output Overvoltage Protection (MAX17021/MAX17082 Only)

The overvoltage-protection (OVP) circuit is designed to protect the CPU against a shorted high-side MOSFET by drawing high current and blowing the battery fuse. The MAX17021/MAX17082 continuously monitor the output for an overvoltage fault. The controller detects an OVP fault if the output voltage exceeds the set VID DAC voltage by more than 300mV , regardless of the operating state. During downward transitions in

Dual-Phase, Quick-PWM Controllers for IMVP-6+/IMVP-6.5 CPU Core Power Supplies

pulse-skipping operation (DPRSLPVR = high), the OVP threshold is set to default.

When the OVP circuit detects an overvoltage fault, the MAX17021/MAX17082 immediately force DL1 high and pull DH1 and DH2 low. This action turns on the synchronous-rectifier MOSFETs with 100% duty and, in turn, rapidly discharges the output filter capacitor and forces the output low. If the condition that caused the overvoltage (such as a shorted high-side MOSFET) persists, the battery fuse will blow. Toggle $\overline{\text{SHDN}}$ or cycle the VCC power supply below 0.5V to clear the fault latch and reactivate the controller.

Overvoltage protection can be disabled through the no-fault test mode (see the *No-Fault Test Mode* section).

Output Undervoltage Protection (UVP)

If the MAX17021/MAX17082/MAX17482 output voltage is 400mV below the target voltage, the controller activates the shutdown sequence and sets the fault latch. Once the controller ramps down to zero, it forces DL1 and DL2 high, and pulls DH1 and DH2 low. Toggle $\overline{\text{SHDN}}$ or cycle the VCC power supply below 0.5V to clear the fault latch and reactivate the controller.

UVP can be disabled through the no-fault test mode (see the *No-Fault Test Mode* section).

Thermal-Fault Protection

The MAX17021/MAX17082/MAX17482 feature a thermal-fault-protection circuit. When the junction temperature rises above +160°C, a thermal sensor sets the fault latch and activates the soft-shutdown sequence. Once the controller ramps down to zero, it forces DL1 and DL2 high, and pulls DH1 and DH2 low. Toggle $\overline{\text{SHDN}}$ or cycle the VCC power supply below 0.5V to clear the fault latch and reactivate the controller after the junction temperature cools by 15°C.

Thermal shutdown can be disabled through the no-fault test mode (see the *No-Fault Test Mode* section).

No-Fault Test Mode

The latched fault-protection features can complicate the process of debugging prototype breadboards since there are (at most) a few milliseconds in which to determine what went wrong. Therefore, a no-fault test mode is provided to disable the fault protection—overvoltage protection, undervoltage protection, and thermal shutdown. Additionally, the test mode clears the fault latch if it has been set. The no-fault test mode is entered by forcing 11V to 13V on $\overline{\text{SHDN}}$.

MOSFET Gate Drivers

The DH₋ and DL₋ drivers are optimized for driving moderate-sized high-side and larger low-side power MOSFETs. This is consistent with the low duty factor seen in notebook applications, where a large V_{IN} - V_{OUT} differential exists. The high-side gate drivers (DH₋) source and sink 2.2A, and the low-side gate drivers (DL₋) source 2.7A and sink 8A. This ensures robust gate drive for high-current applications. The DH₋ floating high-side MOSFET drivers are powered by internal boost switch charge pumps at BST₋, while the DL₋ synchronous-rectifier drivers are powered directly by the 5V bias supply (VDD).

Adaptive dead-time circuits monitor the DL₋ and DH₋ drivers and prevent either FET from turning on until the other is fully off. The adaptive driver dead time allows operation without shoot-through with a wide range of MOSFETs, minimizing delays and maintaining efficiency.

There must be a low-resistance, low-inductance path from the DL₋ and DH₋ drivers to the MOSFET gates for the adaptive dead-time circuits to work properly; otherwise, the sense circuitry in the MAX17021/MAX17082/MAX17482 interprets the MOSFET gates as off while charge actually remains. Use very short, wide traces (50 mils to 100 mils wide if the MOSFET is 1in from the driver).

The internal pulldown transistor that drives DL₋ low is robust, with a 0.25Ω (typ) on-resistance. This helps prevent DL₋ from being pulled up due to capacitive coupling from the drain to the gate of the low-side MOSFETs when the inductor node (LX₋) quickly switches from ground to V_{IN}. Applications with high input voltages and long inductive driver traces might require rising LX₋ edges do not pull up the low-side MOSFETs' gate, causing shoot-through currents. The capacitive coupling between LX₋ and DL₋ created by the MOSFET's gate-to-drain capacitance (C_{RSS}), gate-to-source capacitance (C_{ISS} - C_{RSS}), and additional board parasitics should not exceed the following minimum threshold:

$$V_{GS(TH)} > V_{IN} \left(\frac{C_{RSS}}{C_{ISS}} \right)$$

Typically, adding a 4700pF between DL₋ and power ground (C_{NL} in Figure 11), close to the low-side MOSFETs, greatly reduces coupling. Do not exceed 22nF of total gate capacitance to prevent excessive turn-off delays.

Dual-Phase, Quick-PWM Controllers for IMVP-6+/IMVP-6.5 CPU Core Power Supplies

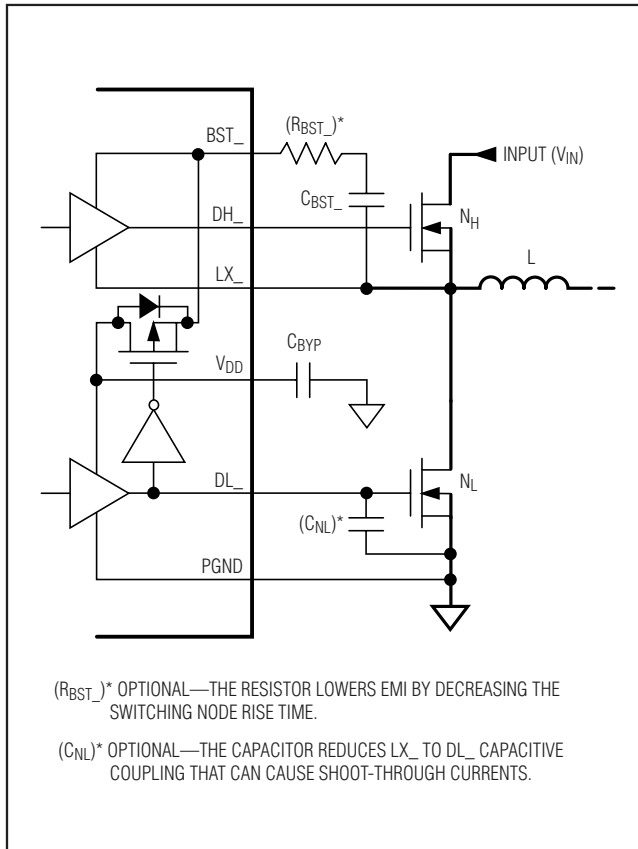

Figure 11. Gate Drive Circuit

Alternatively, shoot-through currents can be caused by a combination of fast high-side MOSFETs and slow low-side MOSFETs. If the turn-off delay time of the low-side MOSFETs are too long, the high-side MOSFETs can turn on before the low-side MOSFETs have actually turned off. Adding a resistor less than 5Ω in series with BST_ slows down the high-side MOSFET turn-on time, eliminating the shoot-through currents without degrading the turn-off time (R_{BST_} in Figure 11). Slowing down the high-side MOSFET also reduces the LX_ node rise time, thereby reducing EMI and high-frequency coupling responsible for switching noise.

Multiphase Quick-PWM Design Procedure

Firmly establish the input-voltage range and maximum load current before choosing a switching frequency and inductor operating point (ripple-current ratio). The primary design trade-off lies in choosing a good switching frequency and inductor operating point, and the following four factors dictate the rest of the design:

- **Input-voltage range:** The maximum value (V_{IN(MAX)}) must accommodate the worst-case high AC adapter voltage. The minimum value (V_{IN(MIN)}) must account for the lowest input voltage after drops due to connectors, fuses, and battery selector switches. If there is a choice at all, lower input voltages result in better efficiency.
- **Maximum load current:** There are two values to consider. The peak load current (I_{LOAD(MAX)}) determines the instantaneous component stresses and filtering requirements, and thus drives output capacitor selection, inductor saturation rating, and the design of the current-limit circuit. The continuous load current (I_{LOAD}) determines the thermal stresses and thus drives the selection of input capacitors, MOSFETs, and other critical heat-contributing components. Modern notebook CPUs generally exhibit I_{LOAD} = I_{LOAD(MAX)} × 80%.
- For multiphase systems, each phase supports a fraction of the load, depending on the current balancing. When properly balanced, the load current is evenly distributed among each phase:

$$I_{LOAD(PHASE)} = \frac{I_{LOAD}}{\eta_{TOTAL}}$$

where η_{TOTAL} is the total number of active phases.

- **Switching frequency:** This choice determines the basic trade-off between size and efficiency. The optimal frequency is largely a function of maximum input voltage, due to MOSFET switching losses that are proportional to frequency and V_{IN}². The optimum frequency is also a moving target due to rapid improvements in MOSFET technology that are making higher frequencies more practical.
- **Inductor operating point:** This choice provides trade-offs between size vs. efficiency and transient response vs. output noise. Low inductor values provide better transient response and smaller physical size, but also result in lower efficiency and higher output noise due to increased ripple current. The minimum practical inductor value is one that causes the circuit to operate at the edge of critical conduction (where the inductor current just touches zero with every cycle at maximum load). Inductor values lower than this grant no further size-reduction benefit. The optimum operating point is usually found between 20% and 50% ripple current.

Dual-Phase, Quick-PWM Controllers for IMVP-6+/IMVP-6.5 CPU Core Power Supplies

Inductor Selection

The switching frequency and operating point (% ripple current or LIR) determine the inductor value as follows:

$$L = \eta_{\text{TOTAL}} \left(\frac{V_{\text{IN}} - V_{\text{OUT}}}{f_{\text{SW}} I_{\text{LOAD(MAX)}} \text{LIR}} \right) \left(\frac{V_{\text{OUT}}}{V_{\text{IN}}} \right)$$

where η_{TOTAL} is the total number of phases.

Find a low-loss inductor having the lowest possible DC resistance that fits in the allotted dimensions. Ferrite cores are often the best choice, although powdered iron is inexpensive and can work well at 200kHz. The core must be large enough not to saturate at the peak inductor current (I_{PEAK}):

$$I_{\text{PEAK}} = \left(\frac{I_{\text{LOAD(MAX)}}}{\eta_{\text{TOTAL}}} \right) \left(1 + \frac{\text{LIR}}{2} \right)$$

Transient Response

The inductor ripple current impacts transient-response performance, especially at low $V_{\text{IN}} - V_{\text{OUT}}$ differentials. Low inductor values allow the inductor current to slew faster, replenishing charge removed from the output filter capacitors by a sudden load step. The amount of output sag is also a function of the maximum duty factor, which can be calculated from the on-time and minimum off-time. For a dual-phase controller, the worst-case output sag voltage can be determined by:

$$V_{\text{SAG}} = \frac{L (\Delta I_{\text{LOAD(MAX)}})^2 \left[\left(\frac{V_{\text{OUT}} T_{\text{SW}}}{V_{\text{IN}}} \right) + t_{\text{OFF(MIN)}} \right]}{2 C_{\text{OUT}} V_{\text{OUT}} \left[\left(\frac{(V_{\text{IN}} - 2V_{\text{OUT}}) T_{\text{SW}}}{V_{\text{IN}}} \right) - 2t_{\text{OFF(MIN)}} \right]} + \frac{\Delta I_{\text{LOAD(MAX)}}}{2 C_{\text{OUT}}} \left[\left(\frac{V_{\text{OUT}} T_{\text{SW}}}{V_{\text{IN}}} \right) + t_{\text{OFF(MIN)}} \right]$$

where $t_{\text{OFF(MIN)}}$ is the minimum off-time (see the *Electrical Characteristics* table). The amount of overshoot due to stored inductor energy can be calculated as:

$$V_{\text{SOAR}} \approx \frac{(\Delta I_{\text{LOAD(MAX)}})^2 L}{2 \eta_{\text{TOTAL}} C_{\text{OUT}} V_{\text{OUT}}}$$

where η_{TOTAL} is the total number of active phases.

Setting the Current Limit

The minimum current-limit threshold must be high enough to support the maximum load current when the current limit is at the minimum tolerance value. The valley of the inductor current occurs at $I_{\text{LOAD(MAX)}}$ minus half the ripple current; therefore:

$$I_{\text{LIMIT(LOW)}} > \left(\frac{I_{\text{LOAD(MAX)}}}{\eta_{\text{TOTAL}}} \right) \left(1 - \frac{\text{LIR}}{2} \right)$$

where η_{TOTAL} is the total number of active phases, and $I_{\text{LIMIT(LOW)}}$ equals the minimum current-limit threshold voltage divided by the current-sense resistor (R_{SENSE}).

Output Capacitor Selection

The output filter capacitor must have low-enough effective series resistance (ESR) to meet output ripple and load-transient requirements, yet have high enough ESR to satisfy stability requirements.

In CPU V_{CORE} converters and other applications where the output is subject to large-load transients, the output capacitor's size typically depends on how much ESR is needed to prevent the output from dipping too low under a load transient. Ignoring the sag due to finite capacitance:

$$(R_{\text{ESR}} + R_{\text{PCB}}) \leq \frac{V_{\text{STEP}}}{\Delta I_{\text{LOAD(MAX)}}}$$

In non-CPU applications, the output capacitor's size often depends on how much ESR is needed to maintain an acceptable level of output ripple voltage. The output ripple voltage of a step-down controller equals the total inductor ripple current multiplied by the output capacitor's ESR. When operating multiphase systems out-of-phase, the peak inductor currents of each phase are staggered, resulting in lower output ripple voltage by reducing the total inductor ripple current. For multiphase operation, the maximum ESR to meet ripple requirements is:

$$R_{\text{ESR}} \leq \left[\frac{V_{\text{IN}} f_{\text{SW}} L}{(V_{\text{IN}} - \eta_{\text{TOTAL}} V_{\text{OUT}}) V_{\text{OUT}}} \right] V_{\text{RIPPLE}}$$

where η_{TOTAL} is the total number of active phases and f_{SW} is the switching frequency per phase. The actual capacitance value required relates to the physical size needed to achieve low ESR, as well as to the chemistry of the capacitor technology. Thus, the capacitor is usually selected by ESR and voltage rating rather than by capacitance value (this is true of polymer types).

Dual-Phase, Quick-PWM Controllers for IMVP-6+/IMVP-6.5 CPU Core Power Supplies

When using low-capacity ceramic filter capacitors, capacitor size is usually determined by the capacity needed to prevent V_{SAG} and V_{SOAR} from causing problems during load transients. Generally, once enough capacitance is added to meet the overshoot requirement, undershoot at the rising load edge is no longer a problem (see the V_{SAG} and V_{SOAR} equations in the *Transient Response* section).

Output Capacitor Stability Considerations

For Quick-PWM controllers, stability is determined by the value of the ESR zero relative to the switching frequency. The boundary of instability is given by the following equation:

$$f_{ESR} \leq \frac{f_{SW}}{\pi}$$

where:

$$f_{ESR} = \frac{1}{2\pi R_{EFF} C_{OUT}}$$

and:

$$R_{EFF} = R_{ESR} + R_{DROOP} + R_{PCB}$$

where C_{OUT} is the total output capacitance, R_{ESR} is the total equivalent series resistance, R_{DROOP} is the voltage-positioning gain, and R_{PCB} is the parasitic board resistance between the output capacitors and sense resistors.

For a standard 300kHz application, the ESR zero frequency must be well below 95kHz, preferably below 50kHz. Tantalum, SANYO POSCAP, and Panasonic SP capacitors in widespread use at the time of publication have typical ESR zero frequencies below 50kHz. In the standard application circuit, the ESR needed to support a 30mV_{p-p} ripple is $30mV/(40A \times 0.3) = 2.5m\Omega$. Four 330 μ F/2.5V Panasonic SP (type SX) capacitors in parallel provide 1.5m Ω (max) ESR. With a 2m Ω droop and 0.5m Ω PCB resistance, the typical combined ESR results in a zero at 30kHz.

Ceramic capacitors have a high-ESR zero frequency, but applications with significant voltage positioning can take advantage of their size and low ESR. Do not put high-value ceramic capacitors directly across the output without verifying that the circuit contains enough voltage positioning and series PCB resistance to ensure stability. When only using ceramic output capacitors, output overshoot (V_{SOAR}) typically determines the minimum output capacitance requirement.

Their relatively low capacitance value can cause output overshoot when stepping from full-load to no-load conditions, unless a small inductor value is used (high switching frequency) to minimize the energy transferred from inductor to capacitor during load-step recovery.

Unstable operation manifests itself in two related but distinctly different ways: double pulsing and feedback-loop instability. Double pulsing occurs due to noise on the output or because the ESR is so low that there is not enough voltage ramp in the output-voltage signal. This “fools” the error comparator into triggering a new cycle immediately after the minimum off-time period has expired. Double pulsing is more annoying than harmful, resulting in nothing worse than increased output ripple. However, it can indicate the possible presence of loop instability due to insufficient ESR. Loop instability can result in oscillations at the output after line or load steps. Such perturbations are usually damped, but can cause the output voltage to rise above or fall below the tolerance limits.

The easiest method for checking stability is to apply a very fast zero-to-max load transient and carefully observe the output-voltage-ripple envelope for overshoot and ringing. It can help to simultaneously monitor the inductor current with an AC current probe. Do not allow more than one cycle of ringing after the initial step-response under/overshoot.

Input Capacitor Selection

The input capacitor must meet the ripple current requirement (I_{RMS}) imposed by the switching currents. The multiphase Quick-PWM controllers operate out-of-phase while the Quick-PWM slave controllers provide selectable out-of-phase or in-phase on-time triggering. Out-of-phase operation reduces the RMS input current by dividing the input current between several staggered stages. For duty cycles less than 100%/ η_{OUTPH} per phase, the I_{RMS} requirements can be determined by the following equation:

$$I_{RMS} = \left(\frac{I_{LOAD}}{\eta_{TOTAL} V_{IN}} \right) \sqrt{\eta_{TOTAL} V_{OUT} (V_{IN} - \eta_{TOTAL} V_{OUT})}$$

where η_{TOTAL} is the total number of out-of-phase switching regulators. The worst-case RMS current requirement occurs when operating with $V_{IN} = 2\eta_{TOTAL} V_{OUT}$. At this point, the above equation simplifies to $I_{RMS} = 0.5 \times I_{LOAD}/\eta_{TOTAL}$.

Dual-Phase, Quick-PWM Controllers for IMVP-6+/IMVP-6.5 CPU Core Power Supplies

For most applications, nontantalum chemistries (ceramic, aluminum, or OS-CON) are preferred due to their resistance to inrush surge currents typical of systems with a mechanical switch or connector in series with the input. If the Quick-PWM controller is operated as the second stage of a two-stage power-conversion system, tantalum input capacitors are acceptable. In either configuration, choose an input capacitor that exhibits less than +10°C temperature rise at the RMS input current for optimal circuit longevity.

Power-MOSFET Selection

Most of the following MOSFET guidelines focus on the challenge of obtaining high load-current capability when using high-voltage (> 20V) AC adapters. Low-current applications usually require less attention.

The high-side MOSFET (N_H) must be able to dissipate the resistive losses plus the switching losses at both $V_{IN(MIN)}$ and $V_{IN(MAX)}$. Calculate both these sums. Ideally, the losses at $V_{IN(MIN)}$ should be approximately equal to losses at $V_{IN(MAX)}$, with lower losses in between. If the losses at $V_{IN(MIN)}$ are significantly higher than the losses at $V_{IN(MAX)}$, consider increasing the size of N_H (reducing $R_{DS(ON)}$ but with higher C_{GATE}). Conversely, if the losses at $V_{IN(MAX)}$ are significantly higher than the losses at $V_{IN(MIN)}$, consider reducing the size of N_H (increasing $R_{DS(ON)}$ to lower C_{GATE}). If V_{IN} does not vary over a wide range, the minimum power dissipation occurs where the resistive losses equal the switching losses.

Choose a low-side MOSFET that has the lowest possible on-resistance ($R_{DS(ON)}$), comes in a moderate-sized package (i.e., one or two 8-pin SOs, DPAK, or D²PAK), and is reasonably priced. Make sure that the DL₋ gate driver can supply sufficient current to support the gate charge and the current injected into the parasitic gate-to-drain capacitor caused by the high-side MOSFET turning on; otherwise, cross-conduction problems might occur (see the *MOSFET Gate Drivers* section).

MOSFET Power Dissipation

Worst-case conduction losses occur at the duty factor extremes. For the high-side MOSFET (N_H), the worst-case power dissipation due to resistance occurs at the minimum input voltage:

$$PD(N_H \text{ Resistive}) = \left(\frac{V_{OUT}}{V_{IN}} \right) \left(\frac{I_{LOAD}}{\eta_{TOTAL}} \right)^2 R_{DS(ON)}$$

where η_{TOTAL} is the total number of phases.

Generally, a small high-side MOSFET is desired to reduce switching losses at high input voltages. However, the $R_{DS(ON)}$ required to stay within package power dissipation often limits how small the MOSFET can be. Again, the optimum occurs when the switching losses equal the conduction ($R_{DS(ON)}$) losses. High-side switching losses do not usually become an issue until the input is greater than approximately 15V.

Calculating the power dissipation in high-side MOSFET (N_H) due to switching losses is difficult since it must allow for difficult quantifying factors that influence the turn-on and turn-off times. These factors include the internal gate resistance, gate charge, threshold voltage, source inductance, and PCB layout characteristics. The following switching-loss calculation provides only a very rough estimate and is no substitute for breadboard evaluation, preferably including verification using a thermocouple mounted on N_H :

$$PD(N_H \text{ Switching}) = \left(\frac{V_{IN(MAX)} I_{LOAD} f_{SW}}{\eta_{TOTAL}} \right) \left(\frac{Q_{G(SW)}}{I_{GATE}} \right) + \frac{C_{OSS} V_{IN}^2 f_{SW}}{2}$$

where C_{OSS} is the N_H MOSFET's output capacitance, $Q_{G(SW)}$ is the charge needed to turn on the N_H MOSFET, and I_{GATE} is the peak gate-drive source/sink current (2.2A typ).

Switching losses in the high-side MOSFET can become an insidious heat problem when maximum AC adapter voltages are applied due to the squared term in the $C \times V_{IN}^2 \times f_{SW}$ switching-loss equation. If the high-side MOSFET chosen for adequate $R_{DS(ON)}$ at low-battery voltages becomes extraordinarily hot when biased from $V_{IN(MAX)}$, consider choosing another MOSFET with lower parasitic capacitance.

For the low-side MOSFET (N_L), the worst-case power dissipation always occurs at maximum input voltage:

$$PD(N_L \text{ Resistive}) = \left[1 - \left(\frac{V_{OUT}}{V_{IN(MAX)}} \right) \right] \left(\frac{I_{LOAD}}{\eta_{TOTAL}} \right)^2 R_{DS(ON)}$$

The worst case for MOSFET power dissipation occurs under heavy overloads that are greater than $I_{LOAD(MAX)}$ but are not quite high enough to exceed

Dual-Phase, Quick-PWM Controllers for IMVP-6+/IMVP-6.5 CPU Core Power Supplies

MAX17021/MAX17082/MAX17482

the current limit and cause the fault latch to trip. To protect against this possibility, you can over design the circuit to tolerate:

$$I_{LOAD} = \eta_{TOTAL} \left(I_{VALLEY(MAX)} + \frac{\Delta I_{INDUCTOR}}{2} \right) \\ = \eta_{TOTAL} I_{VALLEY(MAX)} + \left(\frac{I_{LOAD(MAX)} L I R}{2} \right)$$

where $I_{VALLEY(MAX)}$ is the maximum valley current allowed by the current-limit circuit, including threshold tolerance and on-resistance variation. The MOSFETs must have a good-size heatsink to handle the overload power dissipation.

Choose a Schottky diode (D_L) with a forward voltage low enough to prevent the low-side MOSFET body diode from turning on during the dead time. Select a diode that can handle the load current per phase during the dead times. This diode is optional and can be removed if efficiency is not critical.

Boost Capacitors

The boost capacitors ($C_{BST_}$) must be selected large enough to handle the gate-charging requirements of the high-side MOSFETs. Typically, 0.1 μ F ceramic capacitors work well for low-power applications driving medium-sized MOSFETs. However, high-current applications driving large, high-side MOSFETs require boost capacitors larger than 0.1 μ F. For these applications, select the boost capacitors to avoid discharging the capacitor more than 200mV while charging the high-side MOSFETs' gates:

$$C_{BST_} = \frac{N \times Q_{GATE}}{200mV}$$

where N is the number of high-side MOSFETs used for one regulator, and Q_{GATE} is the gate charge specified in the MOSFET's data sheet. For example, assume (2) IRF7811W n-channel MOSFETs are used on the high side. According to the manufacturer's data sheet, a single IRF7811W has a maximum gate charge of 24nC ($V_{GS} = 5V$). Using the above equation, the required boost capacitance would be:

$$C_{BST_} = \frac{2 \times 24nC}{200mV} = 0.24\mu F$$

Selecting the closest standard value, this example requires a 0.22 μ F ceramic capacitor.

Current-Balance Compensation (CCI)

The current-balance compensation capacitor (C_{CCI}) integrates the difference between the main and secondary current-sense voltages. The internal compensation resistor ($R_{CCI} = 200k\Omega$) improves transient response by increasing the phase margin. This allows the dynamics of the current-balance loop to be optimized. Excessively large capacitor values increase the integration time constant, resulting in larger current differences between the phases during transients.

Excessively small capacitor values allow the current loop to respond cycle-by-cycle, but can result in small DC current variations between the phases. For most applications, a 470pF capacitor from CCI to the switching regulator's output works well.

Connecting the compensation network to the output (V_{OUT}) allows the controller to feed-forward the output-voltage signal, especially during transients.

Voltage Positioning and Loop Compensation

Voltage positioning dynamically lowers the output voltage in response to the load current, reducing the output capacitance and processor's power-dissipation requirements. The controller uses a transconductance amplifier to set the transient and DC output-voltage droop (Figure 3) as a function of the load. This adjustability allows flexibility in the selected current-sense resistor value or inductor DCR, and allows smaller current-sense resistance to be used, reducing the overall power dissipated.

Steady-State Voltage Positioning

Connect a resistor (R_{FB}) between FB and V_{OUT} to set the DC steady-state droop (load line) based on the required voltage-positioning slope (R_{DROOP}):

$$R_{FB} = \frac{R_{DROOP}}{R_{SENSE} G_m(FB)}$$

where the effective current-sense resistance (R_{SENSE}) depends on the current-sense method (see the *Current Sense* section), and the voltage-positioning amplifier's transconductance ($G_m(FB)$) is typically 600 μ S as defined in the *Electrical Characteristics* table. The controller sums together the input signals of the current-sense inputs ($CSP_$, $CSN_$).

When the inductors' DCR is used as the current-sense element ($R_{SENSE} = R_{DCR}$), each current-sense input should include an NTC thermistor to minimize the temperature dependence of the voltage-positioning slope.

Dual-Phase, Quick-PWM Controllers for IMVP-6+/IMVP-6.5 CPU Core Power Supplies

Minimum Input-Voltage Requirements and Dropout Performance

The output-voltage-adjustable range for continuous-conduction operation is restricted by the nonadjustable minimum off-time one-shot and the number of phases. For best dropout performance, use the slower (200kHz) on-time settings. When working with low input voltages, the duty-factor limit must be calculated using worst-case values for on- and off-times. Manufacturing tolerances and internal propagation delays introduce an error to the on-times. This error is greater at higher frequencies. Also, keep in mind that transient-response performance of buck regulators operated too close to dropout is poor, and bulk output capacitance must often be added (see the V_{SAG} equation in the *Multiphase Quick-PWM Design Procedure* section).

The absolute point of dropout is when the inductor current ramps down during the minimum off-time (ΔI_{DOWN}) as much as it ramps up during the on-time (ΔI_{UP}). The ratio $h = \Delta I_{UP}/\Delta I_{DOWN}$ is an indicator of the ability to slew the inductor current higher in response to increased load, and must always be greater than 1. As h approaches 1, the absolute minimum dropout point, the inductor current cannot increase as much during each switching cycle and V_{SAG} greatly increases unless additional output capacitance is used.

A reasonable minimum value for h is 1.5, but adjusting this up or down allows tradeoffs between V_{SAG} , output capacitance, and minimum operating voltage. For a given value of h , the minimum operating voltage can be calculated as:

$$V_{IN(MIN)} = \eta_{TOTAL} \left[\frac{V_{FB} - V_{DROOP} + V_{DIS}}{1 - \eta_{TOTAL} h \times t_{OFF(MIN)} f_{SW}} \right] + V_{CHG} - V_{DIS} + V_{DROOP}$$

where η_{TOTAL} is the total number of out-of-phase switching regulators, V_{FB} is the voltage-positioning droop, V_{DIS} and V_{CHG} are the parasitic voltage drops in the discharge and charge paths (see the *On-Time One-Shot* section), $t_{OFF(MIN)}$ is from the *Electrical Characteristics* table. The absolute minimum input voltage is calculated with $h = 1$.

If the calculated $V_{IN(MIN)}$ is greater than the required minimum input voltage, then reduce the operating frequency or add output capacitance to obtain an acceptable V_{SAG} . If operation near dropout is anticipated, calculate V_{SAG} to be sure of adequate transient response.

Dropout design example:

$$V_{FB} = 1.4V$$

$$f_{SW} = 300kHz$$

$$t_{OFF(MIN)} = 400ns$$

$$V_{DROOP} = 3mV/A \times 30A = 90mV$$

$$V_{DIS} = V_{CHG} = 150mV \text{ (30A Load)}$$

$$h = 1.5 \text{ and } \eta_{TOTAL} = 2:$$

$$V_{IN(MIN)} = 2 \times \left[\frac{1.4V - 90mV + 150mV}{1 - 2 \times (0.4\mu s \times 1.5 \times 300kHz)} \right] + 150mV - 150mV + 90mV = 4.96V$$

Calculating again with $h = 1$ gives the absolute limit of dropout:

$$V_{IN(MIN)} = 2 \times \left[\frac{1.4V - 90mV + 150mV}{1 - 2 \times (0.4\mu s \times 1.0 \times 300kHz)} \right] + 150mV - 150mV + 90mV = 4.07V$$

Therefore, V_{IN} must be greater than 4.1V, even with very large output capacitance, and a practical input voltage with reasonable output capacitance would be 5.0V.

Applications Information

PCB Layout Guidelines

Careful PCB layout is critical to achieve low switching losses and clean, stable operation. The switching power stage requires particular attention. If possible, mount all the power components on the top side of the board with their ground terminals flush against one another. Refer to the MAX17082 evaluation kit specification for a layout example and follow these guidelines for good PCB layout:

- Keep the high-current paths short, especially at the ground terminals. This is essential for stable, jitter-free operation.
- Connect all analog grounds to a separate solid copper plane, which connects to the GND pin of the Quick-PWM controller. This includes the V_{CC} , FB, and GNDS bypass capacitors.
- Keep the power traces and load connections short. This is essential for high efficiency. The use of thick copper PCBs (2oz vs. 1oz) can enhance full-load efficiency by 1% or more. Correctly routing PCB traces is a difficult task that must be approached in terms of fractions of centimeters, where a single m Ω of excess trace resistance causes a measurable efficiency penalty.

Dual-Phase, Quick-PWM Controllers for IMVP-6+/IMVP-6.5 CPU Core Power Supplies

- Keep the high-current, gate-driver traces (DL_, DH_, LX_, and BST_) short and wide to minimize trace resistance and inductance. This is essential for high-power MOSFETs that require low-impedance gate drivers to avoid shoot-through currents.
 - CSP_ and CSN_ connections for current limiting and voltage positioning must be made using Kelvin-sense connections to guarantee the current-sense accuracy.
 - When trade-offs in trace lengths must be made, it is preferable to allow the inductor charging path to be made longer than the discharge path. For example, it is better to allow some extra distance between the input capacitors and the high-side MOSFET than to allow distance between the inductor and the low-side MOSFET or between the inductor and the output filter capacitor.
 - Route high-speed switching nodes away from sensitive analog areas (CCI, FB, CSP_, CSN_, etc.).
- Layout Procedure**
- 1) Place the power components first, with ground terminals adjacent (low-side MOSFET source, C_{IN}, C_{OUT}, and D1 anode). If possible, make all these connections on the top layer with wide, copper-filled areas.
 - 2) Mount the controller IC adjacent to the low-side MOSFET. The DL_ gate traces must be short and wide (50 mils to 100 mils wide if the MOSFET is 1in from the controller IC).
 - 3) Group the gate-drive components (BST_ diodes and capacitors, V_{DD} bypass capacitor) together near the controller IC.
 - 4) Make the DC-DC controller ground connections as shown in Figures 1 and 2. This diagram can be viewed as having four separate ground planes: input/output ground, where all the high-power components go; the power ground plane, where the GND pin and V_{DD} bypass capacitor go; the master's analog ground plane where sensitive analog components go, the master's GND pin and V_{CC} bypass capacitor go; and the slave's analog ground plane where the slave's GND pin and V_{CC} bypass capacitor go. The master's GND plane must meet the GND plane only at a single point directly beneath the IC. Similarly, the slave's GND plane must meet the GND plane only at a single point directly beneath the IC. The respective master and slave ground planes should connect to the high-power output ground with a short metal trace from GND to the source of the low-side MOSFET (the middle of the star ground). This point must also be very close to the output capacitor ground terminal.
 - 5) Connect the output power planes (V_{CORE} and system ground planes) directly to the output filter capacitor positive and negative terminals with multiple vias. Place the entire DC-DC converter circuit as close to the CPU as is practical.

Chip Information

PROCESS: BiCMOS

Package Information

For the latest package outline information and land patterns, go to www.maxim-ic.com/packages.

PACKAGE TYPE	PACKAGE CODE	DOCUMENT NO.
40 TQFN-EP	T4055-2	21-0140

Dual-Phase, Quick-PWM Controllers for IMVP-6+/IMVP-6.5 CPU Core Power Supplies

Revision History

REVISION NUMBER	REVISION DATE	DESCRIPTION	PAGES CHANGED
0	11/08	Initial release	—
1	7/09	Correction to non-OVP version, update IMON equations, fix errors in Figures 1, 2, and 4	1, 2, 4, 13, 14, 16, 19, 22, 25, 33–36, 39, 40, 46, 47

Maxim cannot assume responsibility for use of any circuitry other than circuitry entirely embodied in a Maxim product. No circuit patent licenses are implied. Maxim reserves the right to change the circuitry and specifications without notice at any time.

48 **Maxim Integrated Products, 120 San Gabriel Drive, Sunnyvale, CA 94086 408-737-7600**