

**TEST DATA**

ITEM	SPEC	SAMPLE									
		1	2	3	4	5	6	7	8	9	10
Primary Exciting Current Input 120VAC , 60 Hz	40 mA max	21	22	20							
Primary Load Current Input 120VAC , 60 Hz	55 mA max	32	33	32							
Secondary No Load DC Voltage	7.8V ±0.5V	7.57	7.47	7.44							
Secondary DC Voltage Load 300 mA	4.5V ±0.5V	4.43	4.42	4.47							
Secondary Voltage Load mA	V ± %										
Secondary Voltage Load mA	V ± %										
Secondary Voltage Load mA	V ± %										
Secondary Voltage Load mA	V ± %										
Ripple Voltage Load 300 mA (PK-PK)	2V max	1.2	1.2	1.2							
Hi-Pot Test 3 mA for 3Sec.	Pri. to Sec.	2K VAC	OK	OK	OK						
	Pri. to Core	2K VAC	OK	OK	OK						
	Sec. to Core	1.5K VAC	OK	OK	OK						
Temperature Rise: 70°C MAX measured By Resistance Method (Primary Winding)											
Core Film: SPLIT						Core : EI-28					
Testing Circuit:		1000uF/10V				Output Plug Drawing: PLUG:3.5*1.35mm					
											
Output conductor length:		6FT min ( AWG#24 )									
Input conductor length:		ft min (AWG# )									
(V) <b>Characteristic Curve</b>											
											

## DC Adaptor Specifications

### Internal Construction Drawing and Parts List (Unit: Set or EA)

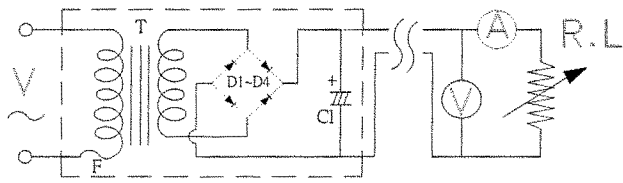
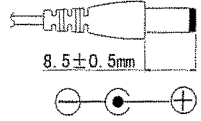
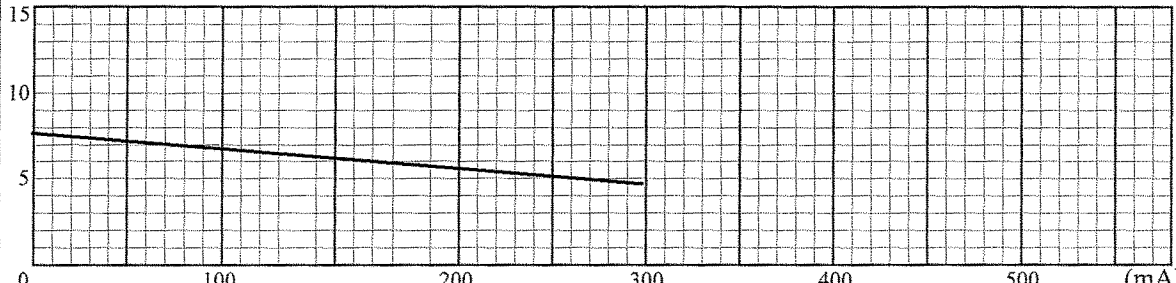
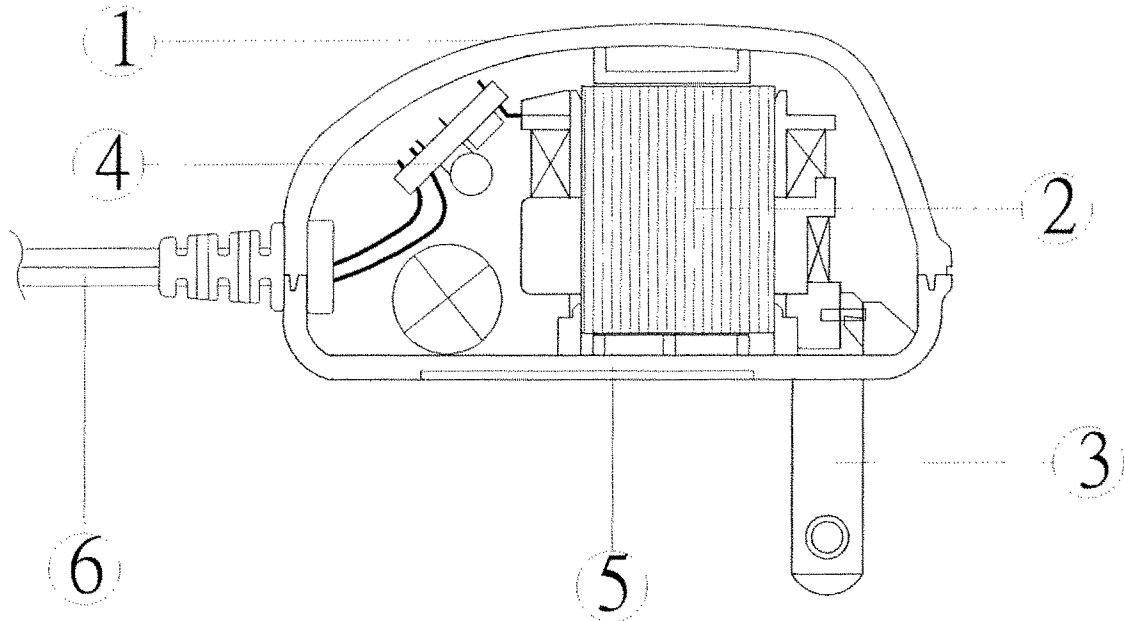

Part Name	Specification	Q'ty
1. Enclosure	Noryl SE1 94V-0 105°C	
	Noryl SE-100 94V-0 95°C	
	Noryl PX1700 94V-0 95°C	
	940(f1) 94V-0 130°C	
2. Transformer	EI-28	1
3. Blade	Ni plated brass	2
<b>4. Print Wiring Board Assembly</b>		
Print Wiring Board	04V0 94V-0 130°C	1
	11 94V-0 105°C	
	13 94V-0 130°C	
	BF-3 94V-0 130°C	
Diode	1A 400-700V IN4004-IN4007	4
Capacitor	1000uf 10V 85°C	1
5. Name Plate	Polyester Film	1
6. Output Cord	AWG# 24 6FT min	1

## DC Adaptor Specifications

### Construction Drawing and Details of Transformer

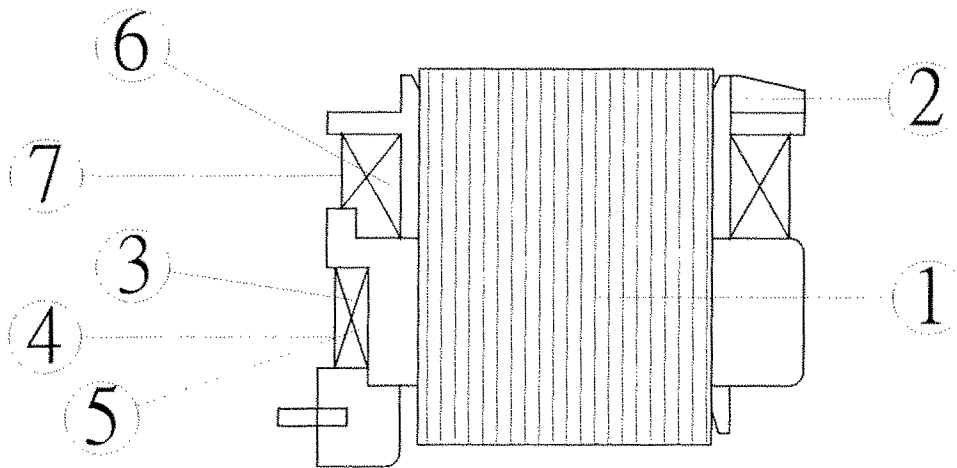

Part Name	Material & Type	Spec or Q'ty
1. Core	Silicon Steel	0.5mm
2. Bobbin	Polybutylene Terephthalate I403G6	0.71mm
	PETP(QMFZ2) FR-530, FR530L	
	Nylon 101L	
3. Primary Winding	Polyurethane Enameled Copper wire	mm turn ohm
4. Primary Outer Winding	Mylar Tape	0.025mmx2T
5. Thermal Fuse	A3 125°C 2A 250VAC	1PCS
	K3 125°C 2A 250VAC	
	M30 125°C 2A 250VAC	
6. Secondary Winding	Polyurethane Enameled Copper Wire	mm turn ohm
7. Secondary Outer Winding	Mylar Tape	0.025mmx2T

## DC Adaptor Specifications

---

### Circuit Diagram

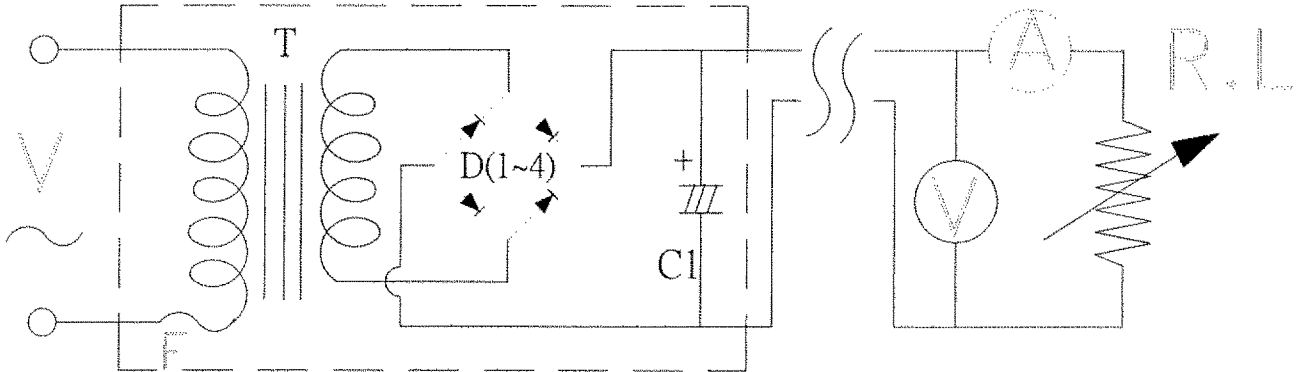

Symbol	Part Name	Note
T	Transformer	EI-28
D(1~4)	Diode	1A 400-700V IN4004-IN4007
C1	Capacitor	1000uF 10V 85°C
F	Thermal	125°C 2A 250V

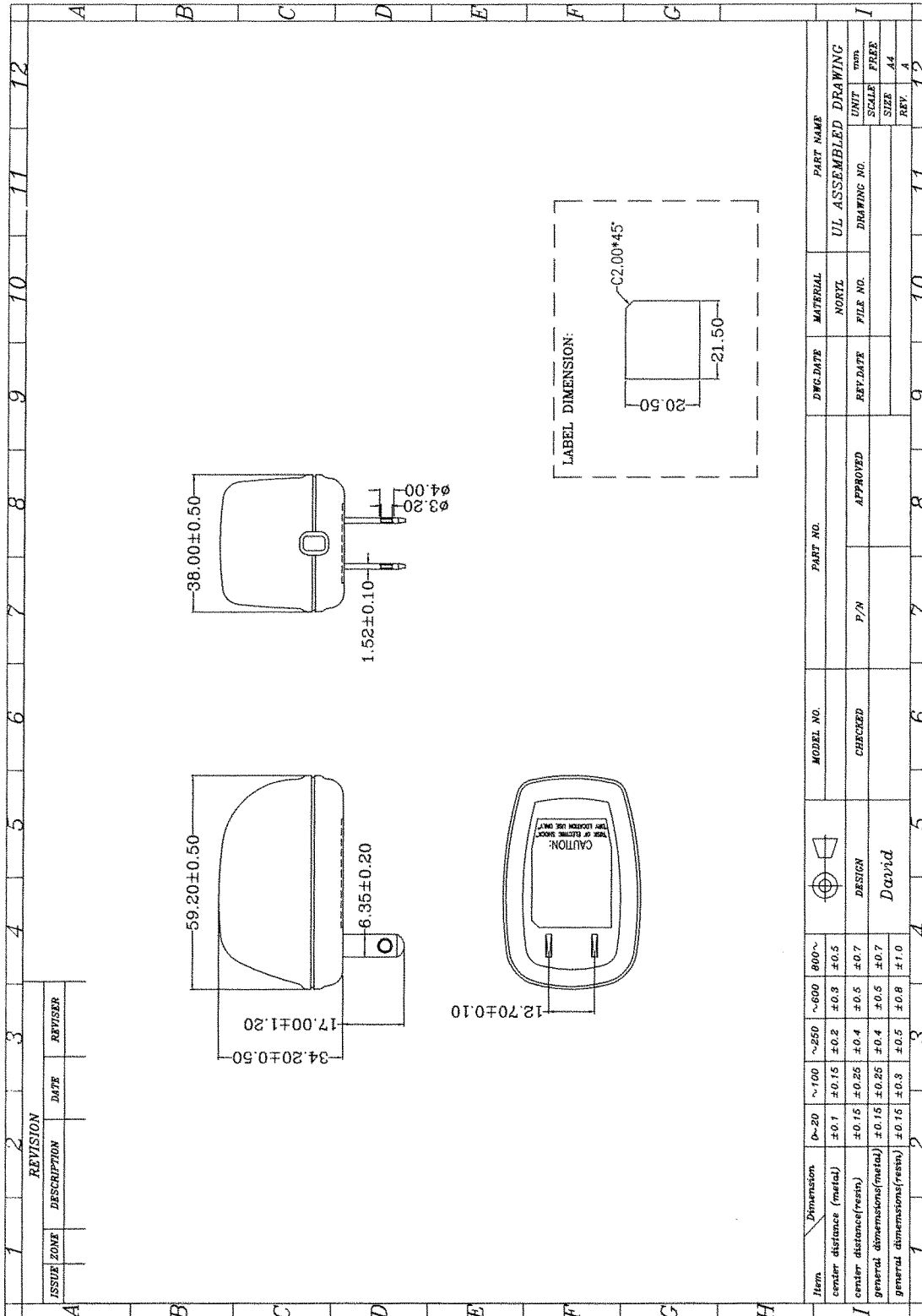

## DC Adaptor Specifications

### Dimension of Nameplate (Unit:mm)

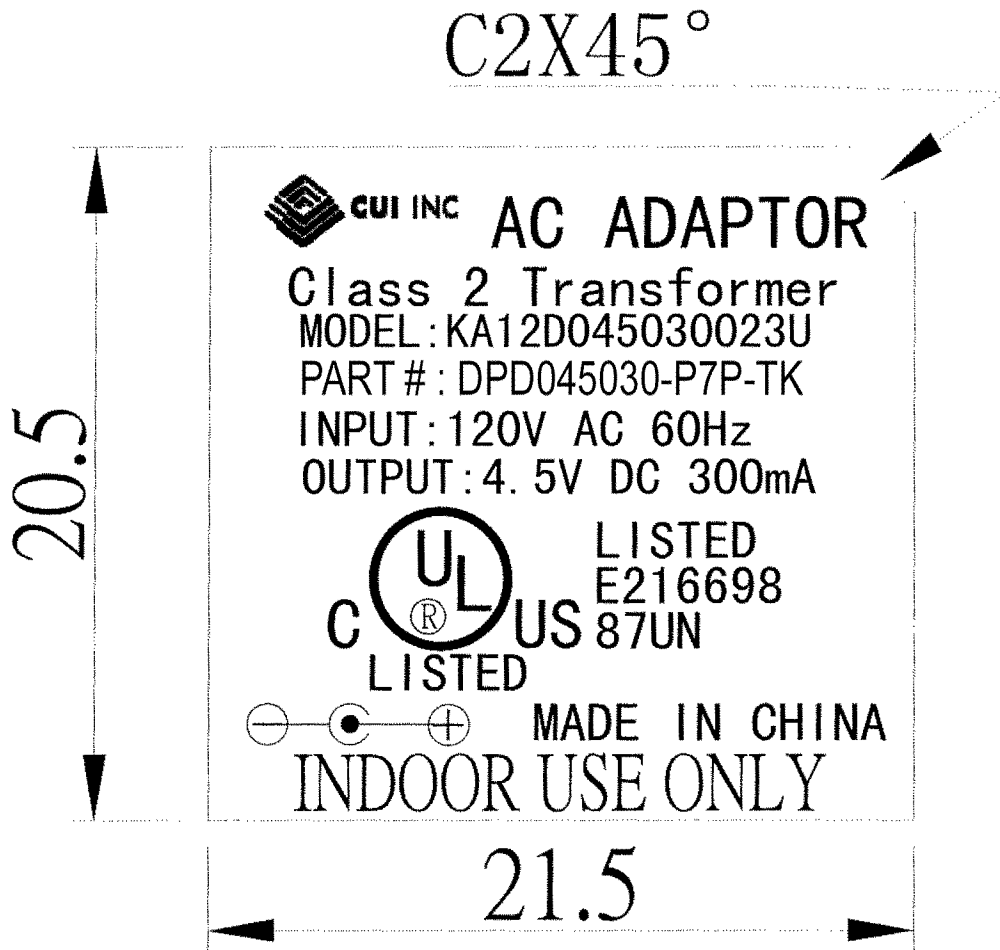

Material: Polyester Film

T: 0.25mm