

Datasheet

22 mm Flush Mount Programmable Multicolor RGB Indicator with Seven Color Flashing Input Control and up to Fourteen Color Options

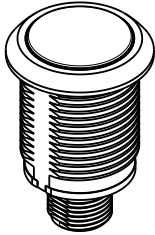

- Bright, uniform indicator light
- Programmable using Banner Pro Editor software and Pro Converter Cable
- Up to fourteen colors in one device (Green, Red, Yellow, Blue, White, Cyan, Magenta, Orange, Amber, Lime Green, Spring Green, Sky Blue, Violet, and Rose)
- 22 mm threaded polycarbonate base
- Translucent polycarbonate window
- Rugged IEC IP66, IEC IP67, and IP69K per DIN 40050-9 design
- Bimodal inputs (PNP/NPN), depending on source wiring
- Seven color models have flashing input control
- Variety of connector options
- Models constructed from FDA-grade materials available
- Terminal connection models available for panel wiring applications

Pro Editor

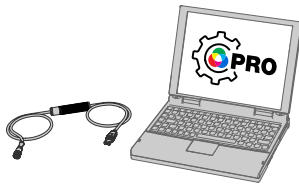

Use Banner's Pro Editor software and Pro Converter Cable to create custom configurations by selecting different colors, flash patterns, and animations.

For more information visit www.bannerengineering.com/proeditor.

Models

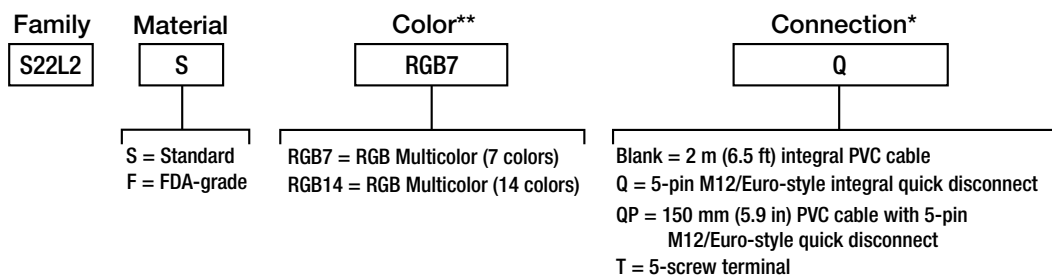

* Models with a quick disconnect require a mating cordset

** 7 Colors = Green, Red, Yellow, Blue, White, Cyan, Magenta with flash input

** 14 Colors = Above colors, plus Orange, Amber, Lime Green, Spring Green, Sky Blue, Violet, and Rose



Wiring Diagrams

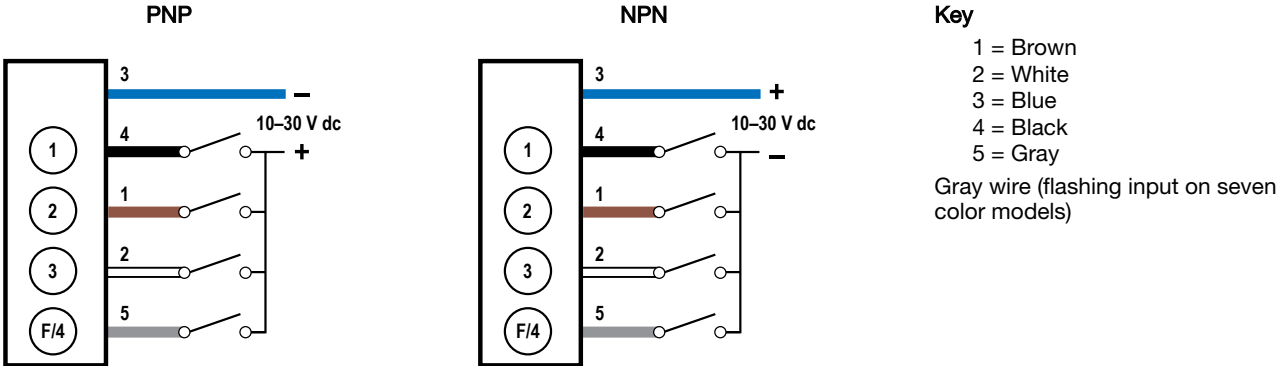

Table 1: Color Definition

	Red	Yellow	Green	Cyan	Blue	Magenta	White	Amber	Rose	Lime Green	Orange	Sky Blue	Violet	Spring Green
Input 1	X	X				X	X		X		X		X	
Input 2		X	X	X			X			X	X			X
Input 3				X	X	X	X					X	X	X
Input 4								X	X	X	X	X	X	X

An "X" denotes an active input, for example when Input 1 and Input 3 are active, the indicator will show Magenta.
 Input 4 is only available on fourteen color models.

Specifications

Supply Voltage

10 V dc to 30 V dc

Supply Current

- 70 mA maximum current at 10 V dc (exclusive of load)
- 60 mA maximum current at 12 V dc (exclusive of load)
- 40 mA maximum current at 24 V dc (exclusive of load)
- 35 mA maximum current at 30 V dc (exclusive of load)

Supply Protection

Protected against reverse polarity and transient voltages

Leakage Current Immunity

400 µA

Pro Editor Configuration

Connection to Pro Editor software enables control of:

- **Animation:** Steady, Flash, Two Color Flash, Intensity Sweep, Demo
- **Color:** Green, Red, Yellow, Blue, White, Cyan, Magenta, Amber, Rose, Lime Green, Orange, Sky Blue, Violet, Spring Green
- **Intensity:** Low, Medium, High
- **Speed:** Slow, Standard, Fast

Pro Converter Cable required to interface between PC and indicator, see accessories

Indicators

7 colors or 14 colors, depending on model
 Only one color can be on at a time

Input Response Time

250 milliseconds maximum

Flash

Default 1.5 Hz flash rate through flash input wire

Connections

Integral 5-pin M12/Euro-style quick disconnect, 150 mm (6 in) PVC cable with a M12/Euro-style quick disconnect, or 2 m (6.5 ft) integral PVC cable, depending on model
Models with a quick disconnect require a mating cordset

Construction

Standard Model Base, Dome, and Nut: polycarbonate
FDA Model Base, Dome, and Nut: FDA-grade copolyester

Mounting

M22 by 1.5 threaded base, maximum torque 2.25 N·m (20 inch·lbf)
Mounting nut included

Vibration and Mechanical Shock

Meets IEC 60068-2-6 requirements (Vibration: 10 Hz to 55 Hz, 1.0 mm amplitude, 5 minutes sweep, 30 minutes dwell)
Meets IEC 60068-2-27 requirements (Shock: 30G 11 ms duration, half sine wave)

Environmental Rating

Standard Models: IEC IP66, IEC IP67, IP69K per DIN 40050-9
Cabled models also meet IP69K per DIN 40050-9 if the cable and cable entrance are protected from high-pressure spray
Indicator side of terminal models meet IP69K per DIN 40050-9 when installed in an enclosure
Screw connection points meet IEC IP00
FDA Models: IEC IP66, IEC IP67, and IP69K per DIN 40050-9

Operating Conditions

-40 °C to +50 °C (-40 °F to +122 °F)
90% at +50 °C maximum relative humidity (non-condensing)
Storage Temperature: -40 °C to +70 °C (-40 °F to +158 °F)

Certifications



Default Indicator Characteristics

Color	Dominant Wavelength (nm) or Color Temperature (CCT)	Color Coordinates ¹		Lumen Output (Typical at 25 °C)
		x	y	
Green	527	0.178	0.700	1.9
Red	625	0.699	0.298	0.80
Yellow	571	0.424	0.511	2.5
Blue	465	0.139	0.052	0.3
White	5700K	0.328	0.337	2.5
Cyan	492	0.158	0.340	2.0
Magenta	-	0.345	0.161	1.2
Amber	585	0.517	0.438	1.8
Rose	-	0.491	0.215	0.9
Lime Green	557	0.347	0.571	2.2
Sky Blue	485	0.151	0.248	1.9
Orange	596	0.585	0.386	1.4
Violet	435	0.204	0.082	0.5
Spring Green	507	0.169	0.524	1.9

Required Overcurrent Protection



WARNING: Electrical connections must be made by qualified personnel in accordance with local and national electrical codes and regulations.

Overcurrent protection is required to be provided by end product application per the supplied table.
Overcurrent protection may be provided with external fusing or via Current Limiting, Class 2 Power Supply.
Supply wiring leads < 24 AWG shall not be spliced.
For additional product support, go to www.bannerengineering.com.

Supply Wiring (AWG)	Required Overcurrent Protection (Amps)
20	5.0
22	3.0
24	2.0
26	1.0
28	0.8
30	0.5

Dimensions

Quick-Disconnect Models

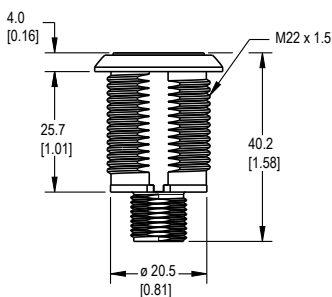

Terminal Models

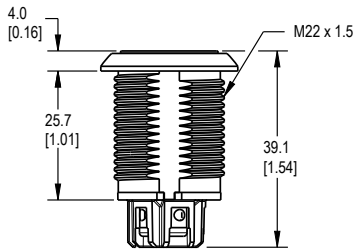

Cabled Models

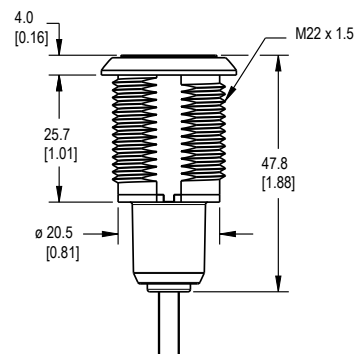

All measurements are listed in millimeters [inches], unless noted otherwise.

¹ Refer to the CIE 1930 (x,y) Chromaticity Diagram, to show equivalent color with indicated color coordinates.

Accessories

Pro Editor Hardware

MQDC-506-USB

- Pro Converter Cable
- 1.83 m (6 ft) M12/Euro-style quick disconnect to Device and USB to PC
- Required for connection to Pro Editor

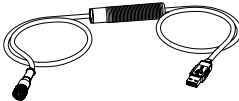

CSB-M1251FM1251M

- 5-pin parallel Y splitter (Male-Male-Female)
- For full Pro Editor preview capability
- Requires external power supply, sold separately

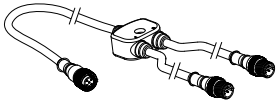

PSW-24-1

- 24 V dc, 1 A power supply
- 2 m (6.5 ft) PVC cable with M12/Euro-style quick disconnect
- Provides external power with splitter cable, sold separately

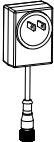

ACC-PRO-CABLE5

- Mating accessory for cabled and terminal models
- 150 mm (6 inch) PVC cable with M12/Euro-style quick disconnect
- Lever wire nuts included (qty 5)
- Required to connect cabled models to Pro Converter Cable, sold separately

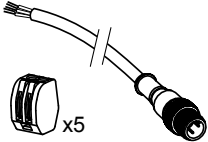

Cordsets

5-Pin Threaded M12/Euro-Style Cordsets—Single Ended				
Model	Length	Style	Dimensions	Pinout (Female)
MQDC1-501.5	0.50 m (1.5 ft)	Straight		<p>1 = Brown 2 = White 3 = Blue 4 = Black 5 = Gray</p>
MQDC1-506	1.83 m (6 ft)			
MQDC1-515	4.57 m (15 ft)			
MQDC1-530	9.14 m (30 ft)			
MQDC1-506RA	1.83 m (6 ft)	Right-Angle		
MQDC1-515RA	4.57 m (15 ft)			
MQDC1-530RA	9.14 m (30 ft)			

5-Pin Threaded M12/Euro-Style Washdown Stainless Steel Cordsets—Double Ended				
Model	Length	Style	Dimensions	Pinout (Female)
MQDC-WDSS-0506	1.83 m (6 ft)	Straight		<p>1 = Brown 2 = White 3 = Blue 4 = Black 5 = Gray</p>
MQDC-WDSS-0515	4.57 m (15 ft)			
MQDC-WDSS-0530	9.14 m (30 ft)			

Splitter Cables for Use with IO-Blocks

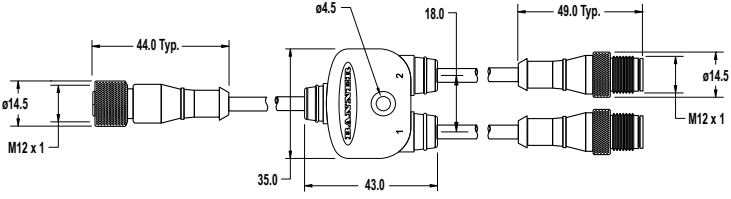
5-Pin Threaded M12/Euro-Style to 4-Pin Threaded M12/Euro Style Combiner Cordset with Flat Junction																		
Model	Branches (Male)	Trunk (Female)	Pinout															
CSF-M12F51M12M41	4-pin Euro Quick Disconnect, 2 x 0.31 m	5-pin Euro Quick Disconnect, 0.31 m	Female															
			Male															
			<table border="1"> <thead> <tr> <th>Trunk</th> <th>Branch 1</th> <th>Branch 2</th> </tr> </thead> <tbody> <tr> <td>1 = Brown</td> <td>1 = NC</td> <td>1 = NC</td> </tr> <tr> <td>2 = White</td> <td>2 = Brown</td> <td>2 = Gray</td> </tr> <tr> <td>3 = Blue</td> <td>3 = Blue</td> <td>3 = Blue</td> </tr> <tr> <td>4 = Black</td> <td>4 = Black</td> <td>4 = White</td> </tr> <tr> <td>5 = Gray</td> <td></td> <td></td> </tr> </tbody> </table>	Trunk	Branch 1	Branch 2	1 = Brown	1 = NC	1 = NC	2 = White	2 = Brown	2 = Gray	3 = Blue	3 = Blue	3 = Blue	4 = Black	4 = Black	4 = White
Trunk	Branch 1	Branch 2																
1 = Brown	1 = NC	1 = NC																
2 = White	2 = Brown	2 = Gray																
3 = Blue	3 = Blue	3 = Blue																
4 = Black	4 = Black	4 = White																
5 = Gray																		

Brackets

SMB22A

- Right-angle bracket with curved slot for versatile orientation
- 12-ga. stainless steel
- Mounting hole for 22 mm sensor

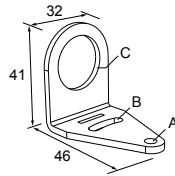

Hole center spacing: A to B = 26.0

Hole size: A = ϕ 4.6, B = 4.6 x 16.9, C = 22.2

SMB22FVK

- V-clamp, flat bracket and fasteners for mounting to pipe or extensions
- Clamp accommodates 28 mm diameter tubing or 1 in. square extrusions
- 22 mm hole for mounting sensor

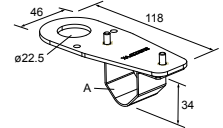

Hole size: A = ϕ 22.5

SMB22RAVK

- V-clamp, right-angle bracket and fasteners for mounting to pipe or extensions
- Clamp accommodates 28 mm diameter tubing or 1 in. square extrusions
- 22 mm hole for mounting sensor

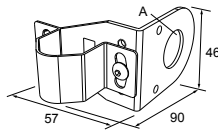

Hole size: A = ϕ 22.5

SMBAMS22P

- Flat SMBAMS series bracket with 22 mm hole for mounting sensors
- Articulation slots for 90+° rotation
- 12-ga. (2.6 mm) cold-rolled steel

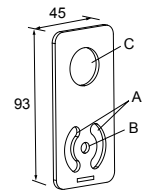

Hole center spacing: A = 26.0, A to B = 13.0

Hole size: A = 26.8 x 7.0, B = ϕ 6.5, C = ϕ 22.5

SMBAMS22RA

- Right-angle SMBAMS series bracket with 22 mm hole for mounting sensors
- Articulation slots for 90+° rotation
- 12-ga. (2.6 mm) cold-rolled steel

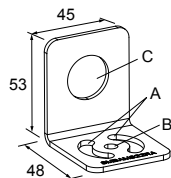

Hole center spacing: A = 26.0, A to B = 13.0

Hole size: A = 26.8 x 7.0, B = ϕ 6.5, C = ϕ 22.5

Banner Engineering Corp. Limited Warranty

Banner Engineering Corp. warrants its products to be free from defects in material and workmanship for one year following the date of shipment. Banner Engineering Corp. will repair or replace, free of charge, any product of its manufacture which, at the time it is returned to the factory, is found to have been defective during the warranty period. This warranty does not cover damage or liability for misuse, abuse, or the improper application or installation of the Banner product.

THIS LIMITED WARRANTY IS EXCLUSIVE AND IN LIEU OF ALL OTHER WARRANTIES WHETHER EXPRESS OR IMPLIED (INCLUDING, WITHOUT LIMITATION, ANY WARRANTY OF MERCHANTABILITY OR FITNESS FOR A PARTICULAR PURPOSE), AND WHETHER ARISING UNDER COURSE OF PERFORMANCE, COURSE OF DEALING OR TRADE USAGE.

This Warranty is exclusive and limited to repair or, at the discretion of Banner Engineering Corp., replacement. **IN NO EVENT SHALL BANNER ENGINEERING CORP. BE LIABLE TO BUYER OR ANY OTHER PERSON OR ENTITY FOR ANY EXTRA COSTS, EXPENSES, LOSSES, LOSS OF PROFITS, OR ANY INCIDENTAL, CONSEQUENTIAL OR SPECIAL DAMAGES RESULTING FROM ANY PRODUCT DEFECT OR FROM THE USE OR INABILITY TO USE THE PRODUCT, WHETHER ARISING IN CONTRACT OR WARRANTY, STATUTE, TORT, STRICT LIABILITY, NEGLIGENCE, OR OTHERWISE.**

Banner Engineering Corp. reserves the right to change, modify or improve the design of the product without assuming any obligations or liabilities relating to any product previously manufactured by Banner Engineering Corp. Any misuse, abuse, or improper application or installation of this product or use of the product for personal protection applications when the product is identified as not intended for such purposes will void the product warranty. Any modifications to this product without prior express approval by Banner Engineering Corp will void the product warranties. All specifications published in this document are subject to change; Banner reserves the right to modify product specifications or update documentation at any time. Specifications and product information in English supersede that which is provided in any other language. For the most recent version of any documentation, refer to: www.bannerengineering.com.

For patent information, see www.bannerengineering.com/patents.

FCC Part 15 and CAN ICES-3 (B)/NMB-3(B)

This device complies with part 15 of the FCC Rules and CAN ICES-3 (B)/NMB-3(B). Operation is subject to the following two conditions:

1. This device may not cause harmful interference, and
2. This device must accept any interference received, including interference that may cause undesired operation.

This equipment has been tested and found to comply with the limits for a Class B digital device, pursuant to part 15 of the FCC Rules and CAN ICES-3 (B)/NMB-3(B). These limits are designed to provide reasonable protection against harmful interference in a residential installation. This equipment generates, uses and can radiate radio frequency energy and, if not installed and used in accordance with the instructions, may cause harmful interference to radio communications. However, there is no guarantee that interference will not occur in a particular installation. If this equipment does cause harmful interference to radio or television reception, which can be determined by turning the equipment off and on, the user is encouraged to try to correct the interference by one or more of the following measures:

- Reorient or relocate the receiving antenna.
- Increase the separation between the equipment and receiver.
- Connect the equipment into an outlet on a circuit different from that to which the receiver is connected.
- Consult the manufacturer.