

SIOV metal oxide varistors

Leaded varistors, StandarD series

Series/Type: B722*
Date: March 2018

© EPCOS AG 2018. Reproduction, publication and dissemination of this publication, enclosures hereto and the information contained therein without EPCOS' prior express consent is prohibited.

EPCOS AG is a TDK Group Company.

Standard series
Construction

- Round varistor element, leaded
- Coating: epoxy resin, flame-retardant to UL 94 V-0
- Terminals: tinned wire

Features

- Wide operating voltage range 11 ... 1100 V_{RMS}
- High surge current ratings up to 8 kA
- No derating up to 105 °C ambient temperature
- PSpice models

Approvals

- UL
- CSA (all types ≥ K115)
- VDE
- CQC S05/07 (K11 ... K460), S10/S14 (K11 ... K680), S20 (K11 ... K1000)
- IEC

Delivery mode

- Bulk (standard), taped versions on reel or in Ammo pack upon request.
- For further details refer to chapter "Taping, packaging and lead configuration" for leaded varistors.

Options

S10* types with lead spacing 5.0 mm and S20* types with lead spacing 7.5 mm are also available on request.

General technical data

| | | | |
|-----------------------|----------------|--------------|-------------------|
| Climatic category | to IEC 60068-1 | 40/105/56 | |
| Operating temperature | to IEC 61051 | -40 ... +105 | °C |
| Storage temperature | | -40 ... +125 | °C |
| Electric strength | to IEC 61051 | ≥ 2.5 | kV _{RMS} |
| Insulation resistance | to IEC 61051 | ≥ 100 | MΩ |

Leaded varistors
B722*
Standard series
Electrical specifications and ordering codes
Maximum ratings ($T_A = 105\text{ }^\circ\text{C}$)

| Ordering code | Type (untaped) SIOV- | V_{RMS} V | V_{DC} V | i_{max} (8/20 μ s) 1 time A | $I_n^{(1)}$ (8/20 μ s) 15 times A | W_{max} (2 ms) J | P_{max} W |
|---|----------------------------|--------------------|-------------------|--|--|--------------------------|--------------------|
| $V_{RMS} = 11\text{ V}$ | | | | | | | |
| B72205S0110K101 | S05K11 | 11 | 14 | 100 | 50 | 0.3 | 0.01 |
| B72207S0110K101 | S07K11 | 11 | 14 | 250 | 100 | 0.8 | 0.02 |
| B72210S0110K101 | S10K11 | 11 | 14 | 500 | 250 | 1.7 | 0.05 |
| B72214S0110K101 | S14K11 | 11 | 14 | 1000 | 500 | 3.2 | 0.10 |
| B72220S0110K101 | S20K11 | 11 | 14 | 2000 | 1000 | 10.0 | 0.20 |
| $V_{RMS} = 14\text{ V}$ | | | | | | | |
| B72205S0140K101 | S05K14 | 14 | 18 | 100 | 50 | 0.4 | 0.01 |
| B72207S0140K101 | S07K14 | 14 | 18 ²⁾ | 250 | 100 | 0.9 | 0.02 |
| B72210S0140K101 | S10K14 | 14 | 18 ²⁾ | 500 | 250 | 2.0 | 0.05 |
| B72214S0140K101 | S14K14 | 14 | 18 ²⁾ | 1000 | 500 | 4.0 | 0.10 |
| B72220S0140K101 | S20K14 | 14 | 18 ²⁾ | 2000 | 1000 | 12.0 | 0.20 |
| $V_{RMS} = 17\text{ V}$ | | | | | | | |
| B72205S0170K101 | S05K17 | 17 | 22 | 100 | 50 | 0.5 | 0.01 |
| B72207S0170K101 | S07K17 | 17 | 22 | 250 | 100 | 1.1 | 0.02 |
| B72210S0170K101 | S10K17 | 17 | 22 | 500 | 250 | 2.5 | 0.05 |
| B72214S0170K101 | S14K17 | 17 | 22 | 1000 | 500 | 5.0 | 0.10 |
| B72220S0170K101 | S20K17 | 17 | 22 | 2000 | 1000 | 14.0 | 0.20 |
| $V_{RMS} = 20\text{ V}$ | | | | | | | |
| B72205S0200K101 | S05K20 | 20 | 26 | 100 | 50 | 0.6 | 0.01 |
| B72207S0200K101 | S07K20 | 20 | 26 | 250 | 100 | 1.3 | 0.02 |
| B72210S0200K101 | S10K20 | 20 | 26 | 500 | 250 | 3.1 | 0.05 |
| B72214S0200K101 | S14K20 | 20 | 26 | 1000 | 500 | 6.0 | 0.10 |
| B72220S0200K101 | S20K20 | 20 | 26 | 2000 | 1000 | 18.0 | 0.20 |
| $V_{RMS} = 25\text{ V}$ | | | | | | | |
| B72205S0250K101 | S05K25 | 25 | 31 | 100 | 50 | 0.7 | 0.01 |
| B72207S0250K101 | S07K25 | 25 | 31 | 250 | 100 | 1.6 | 0.02 |
| B72210S0250K101 | S10K25 | 25 | 31 | 500 | 250 | 3.7 | 0.05 |
| B72214S0250K101 | S14K25 | 25 | 31 | 1000 | 500 | 7.0 | 0.10 |
| B72220S0250K101 | S20K25 | 25 | 31 | 2000 | 1000 | 22.0 | 0.20 |
| $V_{RMS} = 30\text{ V}$ | | | | | | | |
| B72205S0300K101 | S05K30 | 30 | 38 | 100 | 50 | 0.9 | 0.01 |
| B72207S0300K101 | S07K30 | 30 | 38 | 250 | 100 | 2.0 | 0.02 |
| B72210S0300K101 | S10K30 | 30 | 38 | 500 | 250 | 4.4 | 0.05 |
| B72214S0300K101 | S14K30 | 30 | 38 | 1000 | 500 | 9.0 | 0.10 |
| B72220S0300K101 | S20K30 | 30 | 38 | 2000 | 1000 | 26.0 | 0.20 |

1) **Note:** Nominal discharge current I_n , according to UL 1449, 4th edition.

2) Jump-start strength (max. 24 V, 5 minutes)

Characteristics (T_A = 25 °C)

| Ordering code | V _V (1 mA) V | ΔV _V (1 mA) % | V _{C,max} (i _C) V | i _C A | C _{typ} (1 kHz) pF |
|-------------------------------|-------------------------------|--------------------------------|--|---------------------|-----------------------------------|
| V_{RMS} = 11 V | | | | | |
| B72205S0110K101 | 18 | ±10 | 36 | 1.0 | 1750 |
| B72207S0110K101 | 18 | ±10 | 36 | 2.5 | 2750 |
| B72210S0110K101 | 18 | ±10 | 36 | 5.0 | 6250 |
| B72214S0110K101 | 18 | ±10 | 36 | 10.0 | 12100 |
| B72220S0110K101 | 18 | ±10 | 36 | 20.0 | 23000 |
| V_{RMS} = 14 V | | | | | |
| B72205S0140K101 | 22 | ±10 | 43 | 1.0 | 1450 |
| B72207S0140K101 | 22 | ±10 | 43 | 2.5 | 2300 |
| B72210S0140K101 | 22 | ±10 | 43 | 5.0 | 5200 |
| B72214S0140K101 | 22 | ±10 | 43 | 10.0 | 9950 |
| B72220S0140K101 | 22 | ±10 | 43 | 20.0 | 19000 |
| V_{RMS} = 17 V | | | | | |
| B72205S0170K101 | 27 | ±10 | 53 | 1.0 | 1200 |
| B72207S0170K101 | 27 | ±10 | 53 | 2.5 | 1900 |
| B72210S0170K101 | 27 | ±10 | 53 | 5.0 | 4350 |
| B72214S0170K101 | 27 | ±10 | 53 | 10.0 | 8200 |
| B72220S0170K101 | 27 | ±10 | 53 | 20.0 | 15600 |
| V_{RMS} = 20 V | | | | | |
| B72205S0200K101 | 33 | ±10 | 65 | 1.0 | 980 |
| B72207S0200K101 | 33 | ±10 | 65 | 2.5 | 1600 |
| B72210S0200K101 | 33 | ±10 | 65 | 5.0 | 3650 |
| B72214S0200K101 | 33 | ±10 | 65 | 10.0 | 6800 |
| B72220S0200K101 | 33 | ±10 | 65 | 20.0 | 13000 |
| V_{RMS} = 25 V | | | | | |
| B72205S0250K101 | 39 | ±10 | 77 | 1.0 | 850 |
| B72207S0250K101 | 39 | ±10 | 77 | 2.5 | 1400 |
| B72210S0250K101 | 39 | ±10 | 77 | 5.0 | 3200 |
| B72214S0250K101 | 39 | ±10 | 77 | 10.0 | 5850 |
| B72220S0250K101 | 39 | ±10 | 77 | 20.0 | 11100 |
| V_{RMS} = 30 V | | | | | |
| B72205S0300K101 | 47 | ±10 | 93 | 1.0 | 720 |
| B72207S0300K101 | 47 | ±10 | 93 | 2.5 | 1200 |
| B72210S0300K101 | 47 | ±10 | 93 | 5.0 | 2750 |
| B72214S0300K101 | 47 | ±10 | 93 | 10.0 | 4950 |
| B72220S0300K101 | 47 | ±10 | 93 | 20.0 | 9350 |

Leaded varistors
B722*
Standard series
Electrical specifications and ordering codes
Maximum ratings ($T_A = 105\text{ }^\circ\text{C}$)

| Ordering code | Type (untaped) SIOV- | V_{RMS} V | V_{DC} V | i_{max} (8/20 μ s) 1 time A | I_n ¹⁾ (8/20 μ s) 15 times A | W_{max} (2 ms) J | P_{max} W |
|---|----------------------------|--------------------|-------------------|--|--|--------------------------|--------------------|
| $V_{RMS} = 35\text{ V}$ | | | | | | | |
| B72205S0350K101 | S05K35 | 35 | 45 | 100 | 50 | 1.1 | 0.01 |
| B72207S0350K101 | S07K35 | 35 | 45 | 250 | 100 | 2.5 | 0.02 |
| B72210S0350K101 | S10K35 | 35 | 45 | 500 | 250 | 5.4 | 0.05 |
| B72214S0350K101 | S14K35 | 35 | 45 | 1000 | 500 | 10.0 | 0.10 |
| B72220S0350K101 | S20K35 | 35 | 45 | 2000 | 1000 | 33.0 | 0.20 |
| $V_{RMS} = 40\text{ V}$ | | | | | | | |
| B72205S0400K101 | S05K40 | 40 | 56 | 100 | 50 | 1.3 | 0.01 |
| B72207S0400K101 | S07K40 | 40 | 56 | 250 | 100 | 3.0 | 0.02 |
| B72210S0400K101 | S10K40 | 40 | 56 | 500 | 250 | 6.4 | 0.05 |
| B72214S0400K101 | S14K40 | 40 | 56 | 1000 | 500 | 13.0 | 0.10 |
| B72220S0400K101 | S20K40 | 40 | 56 | 2000 | 1000 | 37.0 | 0.20 |
| $V_{RMS} = 50\text{ V}$ | | | | | | | |
| B72205S0500K101 | S05K50 | 50 | 65 | 400 | 150 | 1.8 | 0.10 |
| B72207S0500K101 | S07K50 | 50 | 65 | 1200 | 500 | 4.2 | 0.25 |
| B72210S0500K101 | S10K50 | 50 | 65 | 2500 | 1500 | 8.4 | 0.40 |
| B72214S0500K101 | S14K50 | 50 | 65 | 4500 | 3000 | 15.0 | 0.60 |
| B72220S0500K101 | S20K50 | 50 | 65 | 6500 | 3000 | 27.0 | 1.00 |
| $V_{RMS} = 60\text{ V}$ | | | | | | | |
| B72205S0600K101 | S05K60 | 60 | 85 | 400 | 150 | 2.2 | 0.10 |
| B72207S0600K101 | S07K60 | 60 | 85 | 1200 | 500 | 4.8 | 0.25 |
| B72210S0600K101 | S10K60 | 60 | 85 | 2500 | 1500 | 10.0 | 0.40 |
| B72214S0600K101 | S14K60 | 60 | 85 | 4500 | 3000 | 17.0 | 0.60 |
| B72220S0600K101 | S20K60 | 60 | 85 | 6500 | 3000 | 33.0 | 1.00 |
| $V_{RMS} = 75\text{ V}$ | | | | | | | |
| B72205S0750K101 | S05K75 | 75 | 100 | 400 | 150 | 2.5 | 0.10 |
| B72207S0750K101 | S07K75 | 75 | 100 | 1200 | 500 | 5.9 | 0.25 |
| B72210S0750K101 | S10K75 | 75 | 100 | 2500 | 1500 | 12.0 | 0.40 |
| B72214S0750K101 | S14K75 | 75 | 100 | 4500 | 3000 | 20.0 | 0.60 |
| B72220S0750K101 | S20K75 | 75 | 100 | 6500 | 3000 | 40.0 | 1.00 |
| $V_{RMS} = 95\text{ V}$ | | | | | | | |
| B72205S0950K101 | S05K95 | 95 | 125 | 400 | 150 | 3.4 | 0.10 |
| B72207S0950K101 | S07K95 | 95 | 125 | 1200 | 500 | 7.6 | 0.25 |
| B72210S0950K101 | S10K95 | 95 | 125 | 2500 | 1500 | 15.0 | 0.40 |
| B72214S0950K101 | S14K95 | 95 | 125 | 4500 | 3000 | 25.0 | 0.60 |
| B72220S0950K101 | S20K95 | 95 | 125 | 6500 | 3000 | 50.0 | 1.00 |

¹⁾ **Note:** Nominal discharge current I_n , according to UL 1449, 4th edition.

Characteristics (T_A = 25 °C)

| Ordering code | V _V (1 mA) V | ΔV _V (1 mA) % | V _{C,max} (i _C) V | i _C A | C _{typ} (1 kHz) pF |
|-------------------------------|-------------------------------|--------------------------------|--|---------------------|-----------------------------------|
| V_{RMS} = 35 V | | | | | |
| B72205S0350K101 | 56 | ±10 | 110 | 1.0 | 620 |
| B72207S0350K101 | 56 | ±10 | 110 | 2.5 | 1050 |
| B72210S0350K101 | 56 | ±10 | 110 | 5.0 | 2400 |
| B72214S0350K101 | 56 | ±10 | 110 | 10.0 | 4200 |
| B72220S0350K101 | 56 | ±10 | 110 | 20.0 | 8000 |
| V_{RMS} = 40 V | | | | | |
| B72205S0400K101 | 68 | ±10 | 135 | 1.0 | 520 |
| B72207S0400K101 | 68 | ±10 | 135 | 2.5 | 900 |
| B72210S0400K101 | 68 | ±10 | 135 | 5.0 | 2100 |
| B72214S0400K101 | 68 | ±10 | 135 | 10.0 | 3550 |
| B72220S0400K101 | 68 | ±10 | 135 | 20.0 | 6750 |
| V_{RMS} = 50 V | | | | | |
| B72205S0500K101 | 82 | ±10 | 135 | 5.0 | 300 |
| B72207S0500K101 | 82 | ±10 | 135 | 10.0 | 530 |
| B72210S0500K101 | 82 | ±10 | 135 | 25.0 | 950 |
| B72214S0500K101 | 82 | ±10 | 135 | 50.0 | 1800 |
| B72220S0500K101 | 82 | ±10 | 135 | 100.0 | 3800 |
| V_{RMS} = 60 V | | | | | |
| B72205S0600K101 | 100 | ±10 | 165 | 5.0 | 250 |
| B72207S0600K101 | 100 | ±10 | 165 | 10.0 | 480 |
| B72210S0600K101 | 100 | ±10 | 165 | 25.0 | 870 |
| B72214S0600K101 | 100 | ±10 | 165 | 50.0 | 1650 |
| B72220S0600K101 | 100 | ±10 | 165 | 100.0 | 3600 |
| V_{RMS} = 75 V | | | | | |
| B72205S0750K101 | 120 | ±10 | 200 | 5.0 | 210 |
| B72207S0750K101 | 120 | ±10 | 200 | 10.0 | 430 |
| B72210S0750K101 | 120 | ±10 | 200 | 25.0 | 720 |
| B72214S0750K101 | 120 | ±10 | 200 | 50.0 | 1370 |
| B72220S0750K101 | 120 | ±10 | 200 | 100.0 | 2900 |
| V_{RMS} = 95 V | | | | | |
| B72205S0950K101 | 150 | ±10 | 250 | 5.0 | 185 |
| B72207S0950K101 | 150 | ±10 | 250 | 10.0 | 335 |
| B72210S0950K101 | 150 | ±10 | 250 | 25.0 | 690 |
| B72214S0950K101 | 150 | ±10 | 250 | 50.0 | 1200 |
| B72220S0950K101 | 150 | ±10 | 250 | 100.0 | 2500 |

Leaded varistors
B722*
Standard series
Electrical specifications and ordering codes
Maximum ratings ($T_A = 105\text{ }^\circ\text{C}$)

| Ordering code | Type (untaped) SIOV- | V_{RMS} V | V_{DC} V | i_{max} (8/20 μ s) 1 time A | I_n ¹⁾ (8/20 μ s) 15 times A | W_{max} (2 ms) J | P_{max} W |
|--|----------------------------|--------------------|-------------------|--|--|------------------------------|--------------------|
| $V_{RMS} = 115\text{ V}$ | | | | | | | |
| B72205S0111K101 | S05K115 | 115 | 150 | 400 | 150 | 3.6 | 0.10 |
| B72207S0111K101 | S07K115 | 115 | 150 | 1200 | 500 | 8.4 | 0.25 |
| B72210S0111K101 | S10K115 | 115 | 150 | 2500 | 1500 | 18.0 | 0.40 |
| B72214S0111K101 | S14K115 | 115 | 150 | 4500 | 3000 | 30.0 | 0.60 |
| B72220S0111K101 | S20K115 | 115 | 150 | 6500 | 3000 | 60.0 | 1.00 |
| $V_{RMS} = 130\text{ V}$ | | | | | | | |
| B72205S0131K101 | S05K130 | 130 | 170 | 400 | 150 | 4.2 | 0.10 |
| B72207S0131K101 | S07K130 | 130 | 170 | 1200 | 500 | 9.5 | 0.25 |
| B72210S0131K101 | S10K130 | 130 | 170 | 2500 | 1500 | 19.0 | 0.40 |
| B72214S0131K101 | S14K130 | 130 | 170 | 4500 | 3000 | 34.0 | 0.60 |
| B72220S0131K101 | S20K130 | 130 | 170 | 8000 | 3000 | 74.0 | 1.00 |
| $V_{RMS} = 140\text{ V}$ | | | | | | | |
| B72205S0141K101 | S05K140 | 140 | 180 | 400 | 150 | 4.5 | 0.10 |
| B72207S0141K101 | S07K140 | 140 | 180 | 1200 | 500 | 10.0 | 0.25 |
| B72210S0141K101 | S10K140 | 140 | 180 | 2500 | 1500 | 22.0 | 0.40 |
| B72214S0141K101 | S14K140 | 140 | 180 | 4500 | 3000 | 36.0 | 0.60 |
| B72220S0141K101 | S20K140 | 140 | 180 | 8000 | 3000 | 78.0 | 1.00 |
| $V_{RMS} = 150\text{ V}$ | | | | | | | |
| B72205S0151K101 | S05K150 | 150 | 200 | 400 | 150 | 4.9 | 0.10 |
| B72207S0151K101 | S07K150 | 150 | 200 | 1200 | 500 | 11.0 | 0.25 |
| B72210S0151K101 | S10K150 | 150 | 200 | 2500 | 1500 | 24.0 | 0.40 |
| B72214S0151K101 | S14K150 | 150 | 200 | 4500 | 3000 | 40.0 | 0.60 |
| B72220S0151K101 | S20K150 | 150 | 200 | 8000 | 3000 | 85.0 | 1.00 |
| $V_{RMS} = 175\text{ V}$ | | | | | | | |
| B72205S0171K101 | S05K175 | 175 | 225 | 400 | 150 | 5.6 | 0.10 |
| B72207S0171K101 | S07K175 | 175 | 225 | 1200 | 500 | 13.0 | 0.25 |
| B72210S0171K101 | S10K175 | 175 | 225 | 2500 | 1500 | 28.0 | 0.40 |
| B72214S0171K101 | S14K175 | 175 | 225 | 4500 | 3000 | 46.0 | 0.60 |
| B72220S0171K101 | S20K175 | 175 | 225 | 8000 | 3000 | 98.0 | 1.00 |
| $V_{RMS} = 230\text{ V}$ | | | | | | | |
| B72205S0231K101 | S05K230 | 230 | 300 | 400 | 150 | 7.2 | 0.10 |
| B72207S0231K101 | S07K230 | 230 | 300 | 1200 | 500 | 17.0 | 0.25 |
| B72210S0231K101 | S10K230 | 230 | 300 | 2500 | 1500 | 36.0 | 0.40 |
| B72214S0231K101 | S14K230 | 230 | 300 | 4500 | 3000 | 60.0 | 0.60 |
| B72220S0231K101 | S20K230 | 230 | 300 | 8000 | 3000 | 130.0 | 1.00 |

¹⁾ **Note:** Nominal discharge current I_n according to UL 1449, 4th edition.

Leaded varistors
B722*
StandarD series
Characteristics (T_A = 25 °C)

| Ordering code | V _V (1 mA) V | ΔV _V (1 mA) % | V _{C,max} (i _C) V | i _C A | C _{typ} (1 kHz) pF |
|--------------------------------|-------------------------------|--------------------------------|--|---------------------|-----------------------------------|
| V_{RMS} = 115 V | | | | | |
| B72205S0111K101 | 180 | ±10 | 300 | 5.0 | 155 |
| B72207S0111K101 | 180 | ±10 | 300 | 10.0 | 280 |
| B72210S0111K101 | 180 | ±10 | 300 | 25.0 | 580 |
| B72214S0111K101 | 180 | ±10 | 300 | 50.0 | 1000 |
| B72220S0111K101 | 180 | ±10 | 300 | 100.0 | 2100 |
| V_{RMS} = 130 V | | | | | |
| B72205S0131K101 | 205 | ±10 | 340 | 5.0 | 135 |
| B72207S0131K101 | 205 | ±10 | 340 | 10.0 | 245 |
| B72210S0131K101 | 205 | ±10 | 340 | 25.0 | 500 |
| B72214S0131K101 | 205 | ±10 | 340 | 50.0 | 880 |
| B72220S0131K101 | 205 | ±10 | 340 | 100.0 | 1850 |
| V_{RMS} = 140 V | | | | | |
| B72205S0141K101 | 220 | ±10 | 360 | 5.0 | 125 |
| B72207S0141K101 | 220 | ±10 | 360 | 10.0 | 230 |
| B72210S0141K101 | 220 | ±10 | 360 | 25.0 | 470 |
| B72214S0141K101 | 220 | ±10 | 360 | 50.0 | 820 |
| B72220S0141K101 | 220 | ±10 | 360 | 100.0 | 1700 |
| V_{RMS} = 150 V | | | | | |
| B72205S0151K101 | 240 | ±10 | 395 | 5.0 | 115 |
| B72207S0151K101 | 240 | ±10 | 395 | 10.0 | 210 |
| B72210S0151K101 | 240 | ±10 | 395 | 25.0 | 430 |
| B72214S0151K101 | 240 | ±10 | 395 | 50.0 | 750 |
| B72220S0151K101 | 240 | ±10 | 395 | 100.0 | 1550 |
| V_{RMS} = 175 V | | | | | |
| B72205S0171K101 | 270 | ±10 | 455 | 5.0 | 100 |
| B72207S0171K101 | 270 | ±10 | 455 | 10.0 | 190 |
| B72210S0171K101 | 270 | ±10 | 455 | 25.0 | 380 |
| B72214S0171K101 | 270 | ±10 | 455 | 50.0 | 670 |
| B72220S0171K101 | 270 | ±10 | 455 | 100.0 | 1350 |
| V_{RMS} = 230 V | | | | | |
| B72205S0231K101 | 360 | ±10 | 595 | 5.0 | 70 |
| B72207S0231K101 | 360 | ±10 | 595 | 10.0 | 130 |
| B72210S0231K101 | 360 | ±10 | 595 | 25.0 | 265 |
| B72214S0231K101 | 360 | ±10 | 595 | 50.0 | 530 |
| B72220S0231K101 | 360 | ±10 | 595 | 100.0 | 1000 |

Leaded varistors
B722*
Standard series
Electrical specifications and ordering codes
Maximum ratings ($T_A = 105\text{ }^\circ\text{C}$)

| Ordering code | Type (untaped) SIOV- | V_{RMS} V | V_{DC} V | i_{max} (8/20 μ s) 1 time A | I_n ¹⁾ (8/20 μ s) 15 times A | W_{max} (2 ms) J | P_{max} W |
|--|----------------------------|--------------------|-------------------|--|--|------------------------------|--------------------|
| $V_{RMS} = 250\text{ V}$ | | | | | | | |
| B72205S0251K101 | S05K250 | 250 | 320 | 400 | 150 | 8.2 | 0.10 |
| B72207S0251K101 | S07K250 | 250 | 320 | 1200 | 500 | 19.0 | 0.25 |
| B72210S0251K101 | S10K250 | 250 | 320 | 2500 | 1500 | 38.0 | 0.40 |
| B72214S0251K101 | S14K250 | 250 | 320 | 4500 | 3000 | 65.0 | 0.60 |
| B72220S0251K101 | S20K250 | 250 | 320 | 8000 | 3000 | 140.0 | 1.00 |
| $V_{RMS} = 275\text{ V}$ | | | | | | | |
| B72205S0271K101 | S05K275 | 275 | 350 | 400 | 150 | 8.6 | 0.10 |
| B72207S0271K101 | S07K275 | 275 | 350 | 1200 | 500 | 21.0 | 0.25 |
| B72210S0271K101 | S10K275 | 275 | 350 | 2500 | 1500 | 43.0 | 0.40 |
| B72214S0271K101 | S14K275 | 275 | 350 | 4500 | 3000 | 71.0 | 0.60 |
| B72220S0271K101 | S20K275 | 275 | 350 | 8000 | 3000 | 151.0 | 1.00 |
| $V_{RMS} = 300\text{ V}$ | | | | | | | |
| B72205S0301K101 | S05K300 | 300 | 385 | 400 | 150 | 9.6 | 0.10 |
| B72207S0301K101 | S07K300 | 300 | 385 | 1200 | 500 | 23.0 | 0.25 |
| B72210S0301K101 | S10K300 | 300 | 385 | 2500 | 1500 | 47.0 | 0.40 |
| B72214S0301K101 | S14K300 | 300 | 385 | 4500 | 3000 | 76.0 | 0.60 |
| B72220S0301K101 | S20K300 | 300 | 385 | 8000 | 3000 | 173.0 | 1.00 |
| $V_{RMS} = 320\text{ V}$ | | | | | | | |
| B72205S0321K101 | S05K320 | 320 | 420 | 400 | 150 | 11.0 | 0.10 |
| B72207S0321K101 | S07K320 | 320 | 420 | 1200 | 500 | 25.0 | 0.25 |
| B72210S0321K101 | S10K320 | 320 | 420 | 2500 | 1500 | 50.0 | 0.40 |
| B72214S0321K101 | S14K320 | 320 | 420 | 4500 | 3000 | 84.0 | 0.60 |
| B72220S0321K101 | S20K320 | 320 | 420 | 8000 | 3000 | 184.0 | 1.00 |
| $V_{RMS} = 350\text{ V}$ | | | | | | | |
| B72205S0351K101 | S05K350 | 350 | 460 | 400 | 150 | 12.0 | 0.10 |
| B72207S0351K101 | S07K350 | 350 | 460 | 1200 | 500 | 27.0 | 0.25 |
| B72210S0351K101 | S10K350 | 350 | 460 | 2500 | 1500 | 45.0 | 0.40 |
| B72214S0351K101 | S14K350 | 350 | 460 | 4500 | 3000 | 80.0 | 0.60 |
| B72220S0351K101 | S20K350 | 350 | 460 | 8000 | 3000 | 150.0 | 1.00 |
| $V_{RMS} = 385\text{ V}$ | | | | | | | |
| B72205S0381K101 | S05K385 | 385 | 505 | 400 | 150 | 13.0 | 0.10 |
| B72207S0381K101 | S07K385 | 385 | 505 | 1200 | 500 | 28.0 | 0.25 |
| B72210S0381K101 | S10K385 | 385 | 505 | 2500 | 1500 | 40.0 | 0.40 |
| B72214S0381K101 | S14K385 | 385 | 505 | 4500 | 3000 | 80.0 | 0.60 |
| B72220S0381K101 | S20K385 | 385 | 505 | 8000 | 3000 | 150.0 | 1.00 |

¹⁾ **Note:** Nominal discharge current I_n , according to UL 1449, 4th edition.

Characteristics (T_A = 25 °C)

| Ordering code | V _V (1 mA) V | ΔV _V (1 mA) % | V _{C,max} (i _C) V | i _C A | C _{typ} (1 kHz) pF |
|--------------------------------|-------------------------------|--------------------------------|--|---------------------|-----------------------------------|
| V_{RMS} = 250 V | | | | | |
| B72205S0251K101 | 390 | ±10 | 650 | 5.0 | 65 |
| B72207S0251K101 | 390 | ±10 | 650 | 10.0 | 120 |
| B72210S0251K101 | 390 | ±10 | 650 | 25.0 | 245 |
| B72214S0251K101 | 390 | ±10 | 650 | 50.0 | 490 |
| B72220S0251K101 | 390 | ±10 | 650 | 100.0 | 940 |
| V_{RMS} = 275 V | | | | | |
| B72205S0271K101 | 430 | ±10 | 710 | 5.0 | 60 |
| B72207S0271K101 | 430 | ±10 | 710 | 10.0 | 110 |
| B72210S0271K101 | 430 | ±10 | 710 | 25.0 | 220 |
| B72214S0271K101 | 430 | ±10 | 710 | 50.0 | 440 |
| B72220S0271K101 | 430 | ±10 | 710 | 100.0 | 850 |
| V_{RMS} = 300 V | | | | | |
| B72205S0301K101 | 470 | ±10 | 775 | 5.0 | 55 |
| B72207S0301K101 | 470 | ±10 | 775 | 10.0 | 100 |
| B72210S0301K101 | 470 | ±10 | 775 | 25.0 | 200 |
| B72214S0301K101 | 470 | ±10 | 775 | 50.0 | 400 |
| B72220S0301K101 | 470 | ±10 | 775 | 100.0 | 780 |
| V_{RMS} = 320 V | | | | | |
| B72205S0321K101 | 510 | ±10 | 840 | 5.0 | 50 |
| B72207S0321K101 | 510 | ±10 | 840 | 10.0 | 90 |
| B72210S0321K101 | 510 | ±10 | 840 | 25.0 | 185 |
| B72214S0321K101 | 510 | ±10 | 840 | 50.0 | 370 |
| B72220S0321K101 | 510 | ±10 | 840 | 100.0 | 720 |
| V_{RMS} = 350 V | | | | | |
| B72205S0351K101 | 560 | ±10 | 910 | 5.0 | 48 |
| B72207S0351K101 | 560 | ±10 | 910 | 10.0 | 80 |
| B72210S0351K101 | 560 | ±10 | 910 | 25.0 | 160 |
| B72214S0351K101 | 560 | ±10 | 910 | 50.0 | 350 |
| B72220S0351K101 | 560 | ±10 | 910 | 100.0 | 660 |
| V_{RMS} = 385 V | | | | | |
| B72205S0381K101 | 620 | ±10 | 1025 | 5.0 | 45 |
| B72207S0381K101 | 620 | ±10 | 1025 | 10.0 | 85 |
| B72210S0381K101 | 620 | ±10 | 1025 | 25.0 | 175 |
| B72214S0381K101 | 620 | ±10 | 1025 | 50.0 | 315 |
| B72220S0381K101 | 620 | ±10 | 1025 | 100.0 | 600 |

Leaded varistors
B722*
Standard series
Electrical specifications and ordering codes
Maximum ratings ($T_A = 105\text{ }^\circ\text{C}$)

| Ordering code | Type (untaped) SIOV- | V_{RMS} V | V_{DC} V | i_{max} (8/20 μ s) 1 time A | I_n ¹⁾ (8/20 μ s) 15 times A | W_{max} (2 ms) J | P_{max} W |
|--|----------------------------|--------------------|-------------------|--|--|--------------------------|--------------------|
| $V_{RMS} = 420\text{ V}$ | | | | | | | |
| B72205S0421K101 | S05K420 | 420 | 560 | 400 | 150 | 14.0 | 0.10 |
| B72207S0421K101 | S07K420 | 420 | 560 | 1200 | 500 | 32.0 | 0.25 |
| B72210S0421K101 | S10K420 | 420 | 560 | 2500 | 1500 | 45.0 | 0.40 |
| B72214S0421K101 | S14K420 | 420 | 560 | 4500 | 3000 | 90.0 | 0.60 |
| B72220S0421K101 | S20K420 | 420 | 560 | 8000 | 3000 | 175.0 | 1.00 |
| $V_{RMS} = 440\text{ V}$ | | | | | | | |
| B72205S0441K101 | S05K440 | 440 | 585 | 400 | 150 | 16.0 | 0.10 |
| B72207S0441K101 | S07K440 | 440 | 585 | 1200 | 500 | 34.0 | 0.25 |
| B72210S0441K101 | S10K440 | 440 | 585 | 2500 | 1500 | 47.0 | 0.40 |
| B72214S0441K101 | S14K440 | 440 | 585 | 4500 | 3000 | 95.0 | 0.60 |
| B72220S0441K101 | S20K440 | 440 | 585 | 8000 | 3000 | 185.0 | 1.00 |
| $V_{RMS} = 460\text{ V}$ | | | | | | | |
| B72205S0461K101 | S05K460 | 460 | 615 | 400 | 150 | 18.0 | 0.10 |
| B72207S0461K101 | S07K460 | 460 | 615 | 1200 | 500 | 36.0 | 0.25 |
| B72210S0461K101 | S10K460 | 460 | 615 | 2500 | 1500 | 50.0 | 0.40 |
| B72214S0461K101 | S14K460 | 460 | 615 | 4500 | 3000 | 100.0 | 0.60 |
| B72220S0461K101 | S20K460 | 460 | 615 | 8000 | 3000 | 195.0 | 1.00 |
| $V_{RMS} = 510\text{ V}$ | | | | | | | |
| B72210S0511K101 | S10K510 | 510 | 670 | 2500 | 1500 | 55.0 | 0.40 |
| B72214S0511K101 | S14K510 | 510 | 670 | 4500 | 3000 | 110.0 | 0.60 |
| B72220S0511K101 | S20K510 | 510 | 670 | 6500 | 3000 | 190.0 | 1.00 |
| $V_{RMS} = 550\text{ V}$ | | | | | | | |
| B72210S0551K101 | S10K550 | 550 | 745 | 2500 | 1500 | 60.0 | 0.40 |
| B72214S0551K101 | S14K550 | 550 | 745 | 4500 | 3000 | 120.0 | 0.60 |
| B72220S0551K101 | S20K550 | 550 | 745 | 6500 | 3000 | 210.0 | 1.00 |
| $V_{RMS} = 625\text{ V}$ | | | | | | | |
| B72210S0621K101 | S10K625 | 625 | 825 | 2500 | 1500 | 68.0 | 0.40 |
| B72214S0621K101 | S14K625 | 625 | 825 | 4500 | 3000 | 130.0 | 0.60 |
| B72220S0621K101 | S20K625 | 625 | 825 | 6500 | 3000 | 230.0 | 1.00 |

¹⁾ **Note:** Nominal discharge current I_n , according to UL 1449, 4th edition.

Characteristics (T_A = 25 °C)

| Ordering code | V _V (1 mA) V | ΔV _V (1 mA) % | V _{C,max} (i _C) V | i _C A | C _{typ} (1 kHz) pF |
|--------------------------------|-------------------------------|--------------------------------|--|---------------------|-----------------------------------|
| V_{RMS} = 420 V | | | | | |
| B72205S0421K101 | 680 | ±10 | 1120 | 5.0 | 40 |
| B72207S0421K101 | 680 | ±10 | 1120 | 10.0 | 75 |
| B72210S0421K101 | 680 | ±10 | 1120 | 25.0 | 165 |
| B72214S0421K101 | 680 | ±10 | 1120 | 50.0 | 290 |
| B72220S0421K101 | 680 | ±10 | 1120 | 100.0 | 550 |
| V_{RMS} = 440 V | | | | | |
| B72205S0441K101 | 715 | ±10 | 1180 | 5.0 | 37 |
| B72207S0441K101 | 715 | ±10 | 1180 | 10.0 | 72 |
| B72210S0441K101 | 715 | ±10 | 1180 | 25.0 | 158 |
| B72214S0441K101 | 715 | ±10 | 1180 | 50.0 | 275 |
| B72220S0441K101 | 715 | ±10 | 1180 | 100.0 | 530 |
| V_{RMS} = 460 V | | | | | |
| B72205S0461K101 | 750 | ±10 | 1240 | 5.0 | 35 |
| B72207S0461K101 | 750 | ±10 | 1240 | 10.0 | 70 |
| B72210S0461K101 | 750 | ±10 | 1240 | 25.0 | 150 |
| B72214S0461K101 | 750 | ±10 | 1240 | 50.0 | 260 |
| B72220S0461K101 | 750 | ±10 | 1240 | 100.0 | 500 |
| V_{RMS} = 510 V | | | | | |
| B72210S0511K101 | 820 | ±10 | 1355 | 25.0 | 140 |
| B72214S0511K101 | 820 | ±10 | 1355 | 50.0 | 240 |
| B72220S0511K101 | 820 | ±10 | 1355 | 100.0 | 460 |
| V_{RMS} = 550 V | | | | | |
| B72210S0551K101 | 910 | ±10 | 1500 | 25.0 | 120 |
| B72214S0551K101 | 910 | ±10 | 1500 | 50.0 | 215 |
| B72220S0551K101 | 910 | ±10 | 1500 | 100.0 | 410 |
| V_{RMS} = 625 V | | | | | |
| B72210S0621K101 | 1000 | ±10 | 1650 | 25.0 | 110 |
| B72214S0621K101 | 1000 | ±10 | 1650 | 50.0 | 200 |
| B72220S0621K101 | 1000 | ±10 | 1650 | 100.0 | 380 |

Leaded varistors
B722*
Standard series
Electrical specifications and ordering codes
Maximum ratings ($T_A = 105\text{ °C}$)

| Ordering code | Type (untaped) SIOV- | V_{RMS} V | V_{DC} V | i_{max} (8/20 μ s) 1 time A | $I_n^{1)}$ (8/20 μ s) 15 times A | W_{max} (2 ms) J | P_{max} W |
|---------------------------|----------------------------|--------------------|-------------------|--|---|--------------------------|--------------------|
| $V_{RMS} = 680\text{ V}$ | | | | | | | |
| B72210S0681K101 | S10K680 | 680 | 895 | 2500 | 1500 | 72.0 | 0.40 |
| B72214S0681K101 | S14K680 | 680 | 895 | 4500 | 3000 | 140.0 | 0.60 |
| B72220S0681K101 | S20K680 | 680 | 895 | 6500 | 3000 | 250.0 | 1.00 |
| $V_{RMS} = 1100\text{ V}$ | | | | | | | |
| B72214S0102K101 | S14K1000 ²⁾ | 1100 | 1465 | 4500 | 3000 | 230.0 | 0.60 |
| B72220S0102K101 | S20K1000 ²⁾ | 1100 | 1465 | 6500 | 3000 | 410.0 | 1.00 |

Characteristics ($T_A = 25\text{ °C}$)

| Ordering code | V_v (1 mA) V | ΔV_v (1 mA) % | $V_{c,max}$ (i_c) V | i_c A | C_{typ} (1 kHz) pF |
|---------------------------|----------------------|-----------------------------|-------------------------------|------------|----------------------------|
| $V_{RMS} = 680\text{ V}$ | | | | | |
| B72210S0681K101 | 1100 | ± 10 | 1815 | 25.0 | 100 |
| B72214S0681K101 | 1100 | ± 10 | 1815 | 50.0 | 180 |
| B72220S0681K101 | 1100 | ± 10 | 1815 | 100.0 | 340 |
| $V_{RMS} = 1100\text{ V}$ | | | | | |
| B72214S0102K101 | 1800 | ± 10 | 2970 | 50.0 | 110 |
| B72220S0102K101 | 1800 | ± 10 | 2970 | 100.0 | 210 |

1) Note: Nominal discharge current I_n , according to UL 1449, 4th edition.

2) Operating voltage differs from type designation.

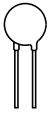
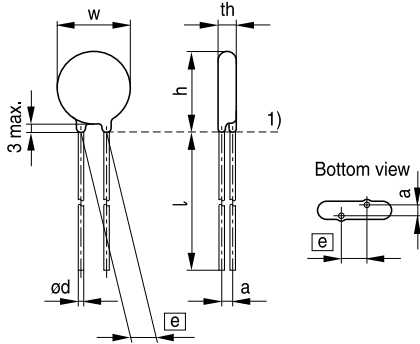
Leaded varistors
B722*
StandarD series
Dimensional drawings

1) Seating plane to IEC 60717

VAR0408-C-E

Weight

| Nominal diameter mm | V_{RMS} V | Weight g |
|------------------------|----------------|--------------|
| 5 | 11 ... 460 | 0.3 ... 0.7 |
| 7 | 11 ... 460 | 0.4 ... 1.1 |
| 10 | 11 ... 680 | 1.0 ... 3.0 |
| 14 | 11 ... 1000 | 1.4 ... 7.6 |
| 20 | 11 ... 1000 | 2.7 ... 15.7 |

The weight of varistors in between these voltage classes can be interpolated.

Dimensions

| Ordering code | [e] ±1 mm | a (typical) mm | w_{max} mm | th_{max} mm | h_{max} mm | l_{min} mm | d ±0.05 mm |
|------------------------------------|--------------|-------------------|-----------------|------------------|-----------------|-----------------|---------------|
| $V_{RMS} = 11 V$ | | | | | | | |
| B72205S0110K101 | 5.0 | 1.2 | 7.0 | 3.3 | 8.5 | 25.0 | 0.6 |
| B72207S0110K101 | 5.0 | 1.2 | 9.0 | 3.4 | 11.0 | 25.0 | 0.6 |
| B72210S0110K101 | 7.5 | 1.4 | 12.0 | 4.0 | 14.5 | 25.0 | 0.8 |
| B72214S0110K101 | 7.5 | 1.4 | 15.5 | 4.0 | 18.5 | 25.0 | 0.8 |
| B72220S0110K101 | 10.0 | 1.5 | 21.5 | 4.5 | 25.5 | 25.0 | 1.0 |
| $V_{RMS} = 14 V$ | | | | | | | |
| B72205S0140K101 | 5.0 | 1.3 | 7.0 | 3.4 | 8.5 | 25.0 | 0.6 |
| B72207S0140K101 | 5.0 | 1.3 | 9.0 | 3.5 | 11.0 | 25.0 | 0.6 |
| B72210S0140K101 | 7.5 | 1.5 | 12.0 | 4.2 | 14.5 | 25.0 | 0.8 |
| B72214S0140K101 | 7.5 | 1.5 | 15.5 | 4.2 | 18.5 | 25.0 | 0.8 |
| B72220S0140K101 | 10.0 | 1.6 | 21.5 | 4.6 | 25.5 | 25.0 | 1.0 |
| $V_{RMS} = 17 V$ | | | | | | | |
| B72205S0170K101 | 5.0 | 1.4 | 7.0 | 3.5 | 8.5 | 25.0 | 0.6 |
| B72207S0170K101 | 5.0 | 1.4 | 9.0 | 3.6 | 11.0 | 25.0 | 0.6 |
| B72210S0170K101 | 7.5 | 1.6 | 12.0 | 4.4 | 14.5 | 25.0 | 0.8 |
| B72214S0170K101 | 7.5 | 1.7 | 15.5 | 4.4 | 18.5 | 25.0 | 0.8 |
| B72220S0170K101 | 10.0 | 1.8 | 21.5 | 4.8 | 25.5 | 25.0 | 1.0 |
| $V_{RMS} = 20 V$ | | | | | | | |
| B72205S0200K101 | 5.0 | 1.2 | 7.0 | 3.5 | 8.5 | 25.0 | 0.6 |
| B72207S0200K101 | 5.0 | 1.2 | 9.0 | 3.6 | 11.0 | 25.0 | 0.6 |
| B72210S0200K101 | 7.5 | 1.6 | 12.0 | 4.5 | 14.5 | 25.0 | 0.8 |
| B72214S0200K101 | 7.5 | 1.6 | 15.5 | 4.6 | 18.5 | 25.0 | 0.8 |
| B72220S0200K101 | 10.0 | 2.1 | 21.5 | 5.1 | 25.5 | 25.0 | 1.0 |

Leaded varistors
B722*
Standard series

| Ordering code | [e] ±1 mm | a (typical) mm | w _{max} mm | th _{max} mm | h _{max} mm | l _{min} mm | d ±0.05 mm |
|-------------------------------|--------------|-------------------|------------------------|-------------------------|------------------------|------------------------|---------------|
| V_{RMS} = 25 V | | | | | | | |
| B72205S0250K101 | 5.0 | 1.3 | 7.0 | 3.6 | 8.5 | 25.0 | 0.6 |
| B72207S0250K101 | 5.0 | 1.3 | 9.0 | 3.7 | 11.0 | 25.0 | 0.6 |
| B72210S0250K101 | 7.5 | 1.4 | 12.0 | 4.2 | 14.5 | 25.0 | 0.8 |
| B72214S0250K101 | 7.5 | 1.4 | 15.5 | 4.2 | 18.5 | 25.0 | 0.8 |
| B72220S0250K101 | 10.0 | 1.8 | 21.5 | 4.7 | 25.5 | 25.0 | 1.0 |
| V_{RMS} = 30 V | | | | | | | |
| B72205S0300K101 | 5.0 | 1.5 | 7.0 | 3.6 | 8.5 | 25.0 | 0.6 |
| B72207S0300K101 | 5.0 | 1.5 | 9.0 | 3.7 | 11.0 | 25.0 | 0.6 |
| B72210S0300K101 | 7.5 | 1.5 | 12.0 | 4.4 | 14.5 | 25.0 | 0.8 |
| B72214S0300K101 | 7.5 | 1.5 | 15.5 | 4.4 | 18.5 | 25.0 | 0.8 |
| B72220S0300K101 | 10.0 | 2.0 | 21.5 | 4.9 | 25.5 | 25.0 | 1.0 |
| V_{RMS} = 35 V | | | | | | | |
| B72205S0350K101 | 5.0 | 1.6 | 7.0 | 3.7 | 8.5 | 25.0 | 0.6 |
| B72207S0350K101 | 5.0 | 1.6 | 9.0 | 3.9 | 11.0 | 25.0 | 0.6 |
| B72210S0350K101 | 7.5 | 1.6 | 12.0 | 4.4 | 14.5 | 25.0 | 0.8 |
| B72214S0350K101 | 7.5 | 1.6 | 15.5 | 4.5 | 18.5 | 25.0 | 0.8 |
| B72220S0350K101 | 10.0 | 2.2 | 21.5 | 5.1 | 25.5 | 25.0 | 1.0 |
| V_{RMS} = 40 V | | | | | | | |
| B72205S0400K101 | 5.0 | 1.8 | 7.0 | 3.9 | 8.5 | 25.0 | 0.6 |
| B72207S0400K101 | 5.0 | 1.8 | 9.0 | 4.1 | 11.0 | 25.0 | 0.6 |
| B72210S0400K101 | 7.5 | 1.7 | 12.0 | 4.8 | 14.5 | 25.0 | 0.8 |
| B72214S0400K101 | 7.5 | 1.7 | 15.5 | 4.9 | 18.5 | 25.0 | 0.8 |
| B72220S0400K101 | 10.0 | 2.4 | 21.5 | 5.4 | 25.5 | 25.0 | 1.0 |
| V_{RMS} = 50 V | | | | | | | |
| B72205S0500K101 | 5.0 | 1.3 | 7.0 | 3.3 | 8.5 | 25.0 | 0.6 |
| B72207S0500K101 | 5.0 | 1.3 | 9.0 | 3.3 | 11.0 | 25.0 | 0.6 |
| B72210S0500K101 | 7.5 | 1.4 | 12.0 | 3.9 | 14.5 | 25.0 | 0.8 |
| B72214S0500K101 | 7.5 | 1.4 | 15.5 | 3.9 | 18.5 | 25.0 | 0.8 |
| B72220S0500K101 | 10.0 | 1.6 | 21.5 | 4.3 | 25.5 | 25.0 | 1.0 |
| V_{RMS} = 60 V | | | | | | | |
| B72205S0600K101 | 5.0 | 1.4 | 7.0 | 3.3 | 8.5 | 25.0 | 0.6 |
| B72207S0600K101 | 5.0 | 1.4 | 9.0 | 3.3 | 11.0 | 25.0 | 0.6 |
| B72210S0600K101 | 7.5 | 1.4 | 12.0 | 4.0 | 14.5 | 25.0 | 0.8 |
| B72214S0600K101 | 7.5 | 1.5 | 15.5 | 4.0 | 18.5 | 25.0 | 0.8 |
| B72220S0600K101 | 10.0 | 1.7 | 21.5 | 4.4 | 25.5 | 25.0 | 1.0 |
| V_{RMS} = 75 V | | | | | | | |
| B72205S0750K101 | 5.0 | 1.5 | 7.0 | 3.4 | 8.5 | 25.0 | 0.6 |
| B72207S0750K101 | 5.0 | 1.5 | 9.0 | 3.6 | 11.0 | 25.0 | 0.6 |
| B72210S0750K101 | 7.5 | 1.5 | 12.0 | 4.2 | 14.5 | 25.0 | 0.8 |
| B72214S0750K101 | 7.5 | 1.5 | 15.5 | 4.2 | 18.5 | 25.0 | 0.8 |
| B72220S0750K101 | 10.0 | 1.8 | 21.5 | 4.6 | 25.5 | 25.0 | 1.0 |

Leaded varistors
B722*
StandarD series

| Ordering code | [e] ±1 mm | a (typical) mm | w _{max} mm | th _{max} mm | h _{max} mm | l _{min} mm | d ±0.05 mm |
|--------------------------------|--------------|-------------------|------------------------|-------------------------|------------------------|------------------------|---------------|
| V_{RMS} = 95 V | | | | | | | |
| B72205S0950K101 | 5.0 | 1.5 | 7.0 | 3.4 | 8.5 | 25.0 | 0.6 |
| B72207S0950K101 | 5.0 | 1.5 | 9.0 | 3.4 | 11.0 | 25.0 | 0.6 |
| B72210S0950K101 | 7.5 | 1.5 | 12.0 | 4.0 | 14.5 | 25.0 | 0.8 |
| B72214S0950K101 | 7.5 | 1.5 | 15.5 | 4.0 | 18.5 | 25.0 | 0.8 |
| B72220S0950K101 | 10.0 | 1.8 | 21.5 | 4.5 | 25.5 | 25.0 | 1.0 |
| V_{RMS} = 115 V | | | | | | | |
| B72205S0111K101 | 5.0 | 1.5 | 7.0 | 3.6 | 8.5 | 25.0 | 0.6 |
| B72207S0111K101 | 5.0 | 1.5 | 9.0 | 3.6 | 11.0 | 25.0 | 0.6 |
| B72210S0111K101 | 7.5 | 1.6 | 12.0 | 4.2 | 14.5 | 25.0 | 0.8 |
| B72214S0111K101 | 7.5 | 1.7 | 15.5 | 4.2 | 18.5 | 25.0 | 0.8 |
| B72220S0111K101 | 10.0 | 1.9 | 21.5 | 4.6 | 25.5 | 25.0 | 1.0 |
| V_{RMS} = 130 V | | | | | | | |
| B72205S0131K101 | 5.0 | 1.6 | 7.0 | 3.6 | 8.5 | 25.0 | 0.6 |
| B72207S0131K101 | 5.0 | 1.6 | 9.0 | 3.6 | 11.0 | 25.0 | 0.6 |
| B72210S0131K101 | 7.5 | 1.8 | 12.0 | 4.2 | 14.5 | 25.0 | 0.8 |
| B72214S0131K101 | 7.5 | 1.9 | 15.5 | 4.2 | 18.5 | 25.0 | 0.8 |
| B72220S0131K101 | 10.0 | 2.0 | 21.5 | 4.7 | 25.5 | 25.0 | 1.0 |
| V_{RMS} = 140 V | | | | | | | |
| B72205S0141K101 | 5.0 | 1.7 | 7.0 | 3.7 | 8.5 | 25.0 | 0.6 |
| B72207S0141K101 | 5.0 | 1.7 | 9.0 | 3.7 | 11.0 | 25.0 | 0.6 |
| B72210S0141K101 | 7.5 | 1.9 | 12.0 | 4.3 | 14.5 | 25.0 | 0.8 |
| B72214S0141K101 | 7.5 | 2.0 | 15.5 | 4.3 | 18.5 | 25.0 | 0.8 |
| B72220S0141K101 | 10.0 | 2.1 | 21.5 | 4.8 | 25.5 | 25.0 | 1.0 |
| V_{RMS} = 150 V | | | | | | | |
| B72205S0151K101 | 5.0 | 1.8 | 7.0 | 3.8 | 8.5 | 25.0 | 0.6 |
| B72207S0151K101 | 5.0 | 1.8 | 9.0 | 3.8 | 11.0 | 25.0 | 0.6 |
| B72210S0151K101 | 7.5 | 2.0 | 12.0 | 4.4 | 14.5 | 25.0 | 0.8 |
| B72214S0151K101 | 7.5 | 2.1 | 15.5 | 4.4 | 18.5 | 25.0 | 0.8 |
| B72220S0151K101 | 10.0 | 2.2 | 21.5 | 4.9 | 25.5 | 25.0 | 1.0 |
| V_{RMS} = 175 V | | | | | | | |
| B72205S0171K101 | 5.0 | 2.0 | 7.0 | 3.9 | 8.5 | 25.0 | 0.6 |
| B72207S0171K101 | 5.0 | 2.0 | 9.0 | 4.0 | 11.0 | 25.0 | 0.6 |
| B72210S0171K101 | 7.5 | 2.2 | 12.0 | 4.6 | 14.5 | 25.0 | 0.8 |
| B72214S0171K101 | 7.5 | 2.2 | 15.5 | 4.6 | 18.5 | 25.0 | 0.8 |
| B72220S0171K101 | 10.0 | 2.3 | 21.5 | 5.0 | 25.5 | 25.0 | 1.0 |
| V_{RMS} = 230 V | | | | | | | |
| B72205S0231K101 | 5.0 | 1.5 | 7.0 | 4.0 | 8.5 | 25.0 | 0.6 |
| B72207S0231K101 | 5.0 | 1.5 | 9.0 | 4.0 | 11.0 | 25.0 | 0.6 |
| B72210S0231K101 | 7.5 | 1.7 | 12.0 | 4.7 | 14.5 | 25.0 | 0.8 |
| B72214S0231K101 | 7.5 | 1.7 | 15.5 | 4.7 | 18.5 | 25.0 | 0.8 |
| B72220S0231K101 | 10.0 | 1.8 | 21.5 | 5.1 | 25.5 | 25.0 | 1.0 |

Leaded varistors
B722*
Standard series

| Ordering code | [e] ±1 mm | a (typical) mm | w _{max} mm | th _{max} mm | h _{max} mm | l _{min} mm | d ±0.05 mm |
|--------------------------------|--------------|-------------------|------------------------|-------------------------|------------------------|------------------------|---------------|
| V_{RMS} = 250 V | | | | | | | |
| B72205S0251K101 | 5.0 | 1.5 | 7.0 | 4.2 | 8.5 | 25.0 | 0.6 |
| B72207S0251K101 | 5.0 | 1.5 | 9.0 | 4.2 | 11.0 | 25.0 | 0.6 |
| B72210S0251K101 | 7.5 | 1.7 | 12.0 | 4.8 | 14.5 | 25.0 | 0.8 |
| B72214S0251K101 | 7.5 | 1.7 | 15.5 | 4.8 | 18.5 | 25.0 | 0.8 |
| B72220S0251K101 | 10.0 | 1.9 | 21.5 | 5.3 | 25.5 | 25.0 | 1.0 |
| V_{RMS} = 275 V | | | | | | | |
| B72205S0271K101 | 5.0 | 1.6 | 7.0 | 4.3 | 8.5 | 25.0 | 0.6 |
| B72207S0271K101 | 5.0 | 1.6 | 9.0 | 4.4 | 11.0 | 25.0 | 0.6 |
| B72210S0271K101 | 7.5 | 1.8 | 12.0 | 5.0 | 14.5 | 25.0 | 0.8 |
| B72214S0271K101 | 7.5 | 1.8 | 15.5 | 5.0 | 18.5 | 25.0 | 0.8 |
| B72220S0271K101 | 10.0 | 2.0 | 21.5 | 5.4 | 25.5 | 25.0 | 1.0 |
| V_{RMS} = 300 V | | | | | | | |
| B72205S0301K101 | 5.0 | 1.7 | 7.0 | 4.5 | 8.5 | 25.0 | 0.6 |
| B72207S0301K101 | 5.0 | 1.7 | 9.0 | 4.5 | 11.0 | 25.0 | 0.6 |
| B72210S0301K101 | 7.5 | 1.9 | 12.0 | 5.1 | 14.5 | 25.0 | 0.8 |
| B72214S0301K101 | 7.5 | 1.9 | 15.5 | 5.2 | 18.5 | 25.0 | 0.8 |
| B72220S0301K101 | 10.0 | 2.1 | 21.5 | 5.6 | 25.5 | 25.0 | 1.0 |
| V_{RMS} = 320 V | | | | | | | |
| B72205S0321K101 | 5.0 | 1.9 | 7.0 | 4.8 | 9.0 | 25.0 | 0.6 |
| B72207S0321K101 | 5.0 | 1.9 | 9.0 | 4.8 | 11.5 | 25.0 | 0.6 |
| B72210S0321K101 | 7.5 | 2.1 | 12.0 | 5.4 | 15.0 | 25.0 | 0.8 |
| B72214S0321K101 | 7.5 | 2.1 | 15.5 | 5.4 | 19.0 | 25.0 | 0.8 |
| B72220S0321K101 | 10.0 | 2.3 | 21.5 | 5.8 | 25.5 | 25.0 | 1.0 |
| V_{RMS} = 350 V | | | | | | | |
| B72205S0351K101 | 5.0 | 2.0 | 7.0 | 4.9 | 9.0 | 25.0 | 0.6 |
| B72207S0351K101 | 5.0 | 2.0 | 9.0 | 4.9 | 11.5 | 25.0 | 0.6 |
| B72210S0351K101 | 7.5 | 2.2 | 12.0 | 5.6 | 15.0 | 25.0 | 0.8 |
| B72214S0351K101 | 7.5 | 2.2 | 15.5 | 5.6 | 19.0 | 25.0 | 0.8 |
| B72220S0351K101 | 10.0 | 2.4 | 21.5 | 6.0 | 25.5 | 25.0 | 1.0 |
| V_{RMS} = 385 V | | | | | | | |
| B72205S0381K101 | 5.0 | 2.1 | 7.0 | 5.1 | 9.0 | 25.0 | 0.6 |
| B72207S0381K101 | 5.0 | 2.1 | 9.0 | 5.2 | 11.5 | 25.0 | 0.6 |
| B72210S0381K101 | 7.5 | 2.4 | 12.0 | 5.8 | 15.0 | 25.0 | 0.8 |
| B72214S0381K101 | 7.5 | 2.4 | 15.5 | 5.9 | 19.0 | 25.0 | 0.8 |
| B72220S0381K101 | 10.0 | 2.5 | 21.5 | 6.3 | 26.0 | 25.0 | 1.0 |

Leaded varistors
B722*
Standard series

| Ordering code | [e] ±1 mm | a (typical) mm | w _{max} mm | th _{max} mm | h _{max} mm | l _{min} mm | d ±0.05 mm |
|---------------------------------|--------------|-------------------|------------------------|-------------------------|------------------------|------------------------|---------------|
| V_{RMS} = 420 V | | | | | | | |
| B72205S0421K101 | 5.0 | 2.4 | 7.0 | 5.4 | 9.0 | 25.0 | 0.6 |
| B72207S0421K101 | 5.0 | 2.4 | 9.0 | 5.4 | 11.5 | 25.0 | 0.6 |
| B72210S0421K101 | 7.5 | 2.6 | 12.0 | 6.1 | 15.0 | 25.0 | 0.8 |
| B72214S0421K101 | 7.5 | 2.6 | 15.5 | 6.1 | 19.0 | 25.0 | 0.8 |
| B72220S0421K101 | 10.0 | 2.7 | 21.5 | 6.5 | 26.0 | 25.0 | 1.0 |
| V_{RMS} = 440 V | | | | | | | |
| B72205S0441K101 | 5.0 | 2.4 | 7.0 | 5.5 | 9.0 | 25.0 | 0.6 |
| B72207S0441K101 | 5.0 | 2.4 | 9.0 | 5.5 | 11.5 | 25.0 | 0.6 |
| B72210S0441K101 | 7.5 | 2.7 | 12.0 | 6.2 | 15.0 | 25.0 | 0.8 |
| B72214S0441K101 | 7.5 | 2.7 | 15.5 | 6.3 | 19.0 | 25.0 | 0.8 |
| B72220S0441K101 | 10.0 | 2.8 | 21.5 | 6.7 | 26.0 | 25.0 | 1.0 |
| V_{RMS} = 460 V | | | | | | | |
| B72205S0461K101 | 5.0 | 2.6 | 7.0 | 5.7 | 9.0 | 25.0 | 0.6 |
| B72207S0461K101 | 5.0 | 2.6 | 9.0 | 5.7 | 11.5 | 25.0 | 0.6 |
| B72210S0461K101 | 7.5 | 2.8 | 12.0 | 6.3 | 15.0 | 25.0 | 0.8 |
| B72214S0461K101 | 7.5 | 2.8 | 15.5 | 6.4 | 19.0 | 25.0 | 0.8 |
| B72220S0461K101 | 10.0 | 3.0 | 21.5 | 6.8 | 26.0 | 25.0 | 1.0 |
| V_{RMS} = 510 V | | | | | | | |
| B72210S0511K101 | 7.5 | 3.1 | 12.0 | 6.7 | 15.0 | 25.0 | 0.8 |
| B72214S0511K101 | 7.5 | 3.1 | 15.5 | 6.8 | 19.0 | 25.0 | 0.8 |
| B72220S0511K101 | 10.0 | 3.2 | 21.5 | 7.1 | 26.0 | 25.0 | 1.0 |
| V_{RMS} = 550 V | | | | | | | |
| B72210S0551K101 | 7.5 | 3.4 | 12.0 | 7.1 | 15.0 | 25.0 | 0.8 |
| B72214S0551K101 | 7.5 | 3.4 | 15.5 | 7.2 | 19.0 | 25.0 | 0.8 |
| B72220S0551K101 | 10.0 | 3.6 | 21.5 | 7.5 | 26.0 | 25.0 | 1.0 |
| V_{RMS} = 625 V | | | | | | | |
| B72210S0621K101 | 7.5 | 3.7 | 12.0 | 7.5 | 15.0 | 25.0 | 0.8 |
| B72214S0621K101 | 7.5 | 3.7 | 15.5 | 7.5 | 19.0 | 25.0 | 0.8 |
| B72220S0621K101 | 10.0 | 3.9 | 21.5 | 7.9 | 26.0 | 25.0 | 1.0 |
| V_{RMS} = 680 V | | | | | | | |
| B72210S0681K101 | 7.5 | 4.1 | 12.0 | 7.9 | 15.0 | 25.0 | 0.8 |
| B72214S0681K101 | 7.5 | 4.1 | 15.5 | 8.0 | 19.0 | 25.0 | 0.8 |
| B72220S0681K101 | 10.0 | 4.2 | 21.5 | 8.4 | 26.0 | 25.0 | 1.0 |
| V_{RMS} = 1100 V | | | | | | | |
| B72214S0102K101 | 7.5 | 6.3 | 15.5 | 11.0 | 20.5 | 25.0 | 0.8 |
| B72220S0102K101 | 10.0 | 6.4 | 21.5 | 11.4 | 28.5 | 25.0 | 1.0 |



Leaded varistors

B722*

Standard series

Reliability data

| Test | Test methods/conditions | Requirement |
|---|--|---|
| Varistor voltage | The voltage between two terminals with the specified measuring current applied is called V_V (1 mA _{DC} @ 0.2 ... 2 s). | To meet the specified value |
| Clamping voltage | The maximum voltage between two terminals with the specified standard impulse current (8/20 μ s) applied. | To meet the specified value |
| Endurance at upper category temperature | 1000 h at UCT After having continuously applied the maximum allowable AC voltage at UCT ± 2 °C for 1000 h, the specimen shall be stored at room temperature and normal humidity for 1 to 2 h. Thereafter, the change of V_V shall be measured. | $ \Delta V/V$ (1 mA) $\leq 10\%$ |
| Surge current derating, 8/20 μ s | 10 surge currents (8/20 μ s), unipolar, interval 30 s, amplitude corresponding to derating curve for 10 impulses at 20 μ s | $ \Delta V/V$ (1 mA) $\leq 10\%$ (measured in direction of surge current) No visible damage |
| Surge current derating, 2 ms | 10 surge currents (2 ms), unipolar, interval 120 s, amplitude corresponding to derating curve for 10 impulses at 2 ms | $ \Delta V/V$ (1 mA) $\leq 10\%$ (measured in direction of surge current) No visible damage |
| Electric strength | IEC 61051-1, test 4.9.2 Metal balls method, 2500 V _{RMS} , 60 s The varistor is placed in a container holding 1.6 \pm 0.2 mm diameter metal balls such that only the terminations of the varistor are protruding. The specified voltage shall be applied between both terminals of the specimen connected together and the electrode inserted between the metal balls. | No breakdown |



| Test | Test methods/conditions | Requirement |
|-----------------------------|--|---|
| Climatic sequence | <p>The specimen shall be subjected to:</p> <p>a) dry heat at UCT, 16 h, IEC 60068-2-2, test Ba</p> <p>b) damp heat, 1st cycle: 55 °C, 93% r. H., 24 h, IEC 60068-2-30, test Db</p> <p>c) cold, LCT, 2 h, IEC 60068-2-1, test Aa</p> <p>d) damp heat, additional 5 cycles: 55 °C/25 °C, 93% r. H., 24 h/cycle, IEC 60068-2-30, test Db.</p> <p>Then the specimen shall be stored at room temperature and normal humidity for 1 to 2 h.</p> <p>Thereafter, the change of V_V shall be measured. Thereafter, insulation resistance R_{ins} shall be measured at $V = 500 V$.</p> | $ \Delta V/V (1 mA) \leq 10\%$ $R_{ins} \geq 100 M\Omega$ |
| Rapid change of temperature | IEC 60068-2-14, test Na, LCT/UCT, dwell time 30 min, 5 cycles | $ \Delta V/V (1 mA) \leq 5\%$ No visible damage |
| Damp heat, steady state | IEC 60068-2-78, test Ca The specimen shall be subjected to 40 ± 2 °C, 90 to 95% r. H. for 56 days without load / with 10% of the maximum continuous DC operating voltage V_{DC} . Then stored at room temperature and normal humidity for 1 to 2 h. Thereafter, the change of V_V shall be measured. Thereafter, insulation resistance R_{ins} shall be measured at $V = 500 V$ (insulated varistors only). | $ \Delta V/V (1 mA) \leq 10\%$ $R_{ins} \geq 100 M\Omega$ |



| Test | Test methods/conditions | Requirement |
|------------------------------|--|--|
| Solderability | <p>IEC 60068-2-20, test Ta, method 1 with modified conditions for lead-free solder alloys: 245 °C, 3 s:</p> <p>After dipping the terminals to a depth of approximately 3 mm from the body in a soldering bath of 245 °C for 3 s, the terminals shall be visually examined.</p> | <p>The inspection shall be carried out under adequate light with normal eyesight or with the assistance of a magnifier capable of giving a magnification of 4 to 10 times. The dipped surface shall be covered with a smooth and bright solder coating with no more than small amounts of scattered imperfections such as pinholes or un-wetted or de-wetted areas. These imperfections shall not be concentrated in one area.</p> |
| Resistance to soldering heat | <p>IEC 60068-2-20, test Tb, method 1A, 260 °C, 10 s:</p> <p>Each lead shall be dipped into a solder bath having a temperature of 260 ±5 °C to a point 2.0 to 2.5 mm from the body of the specimen, be held there for 10 ±1 s and then be stored at room temperature and normal humidity for 1 to 2 h.</p> <p>The change of V_V shall be measured and the specimen shall be visually examined.</p> | <p>$\Delta V/V (1 \text{ mA}) \leq 5\%$</p> <p>No visible damage</p> |
| Tensile strength | <p>IEC 60068-2-21, test Ua1</p> <p>After gradually applying the force specified below and keeping the unit fixed for 10 s, the terminal shall be visually examined for any damage.</p> <p>Force for wire diameter:</p> <p>0.6 mm = 10 N 0.8 mm = 10 N 1.0 mm = 20 N</p> | <p>$\Delta V/V (1 \text{ mA}) \leq 5\%$</p> <p>No break of solder joint, no wire break</p> |

Leaded varistors
B722*
StandarD series

| Test | Test methods/conditions | Requirement |
|-------------|--|---|
| Vibration | IEC 60068-2-6, test Fc, method B4 Frequency range: 10 ... 55 Hz Amplitude: 0.75 mm or 98 m/s ² Duration: 6 h (3 · 2 h) Pulse: sine wave After repeatedly applying a single harmonic vibration according to the table above. The change of V _v shall be measured and the specimen shall be visually examined. | $ \Delta V/V (1 \text{ mA}) \leq 5\%$ No visible damage |
| Bump | IEC 60068-2-29, test Eb Pulse duration: 6 ms Max. acceleration: 400 m/s ² Number of bumps: 4000 Pulse: half sine | $ \Delta V/V (1 \text{ mA}) \leq 5\%$ No visible damage |
| Fire hazard | IEC 60695-11-5 (needle flame test) Severity: vertical 10 s | 5 s max. |

Note:

UCT = Upper category temperature

LCT = Lower category temperature

 R_{ins} = Insulation resistance



v/i characteristics

$v = f(i)$ - for explanation of the characteristics refer to "General technical information", 1.6.3
 A = Leakage current, B = Protection level } for worst-case varistor tolerances

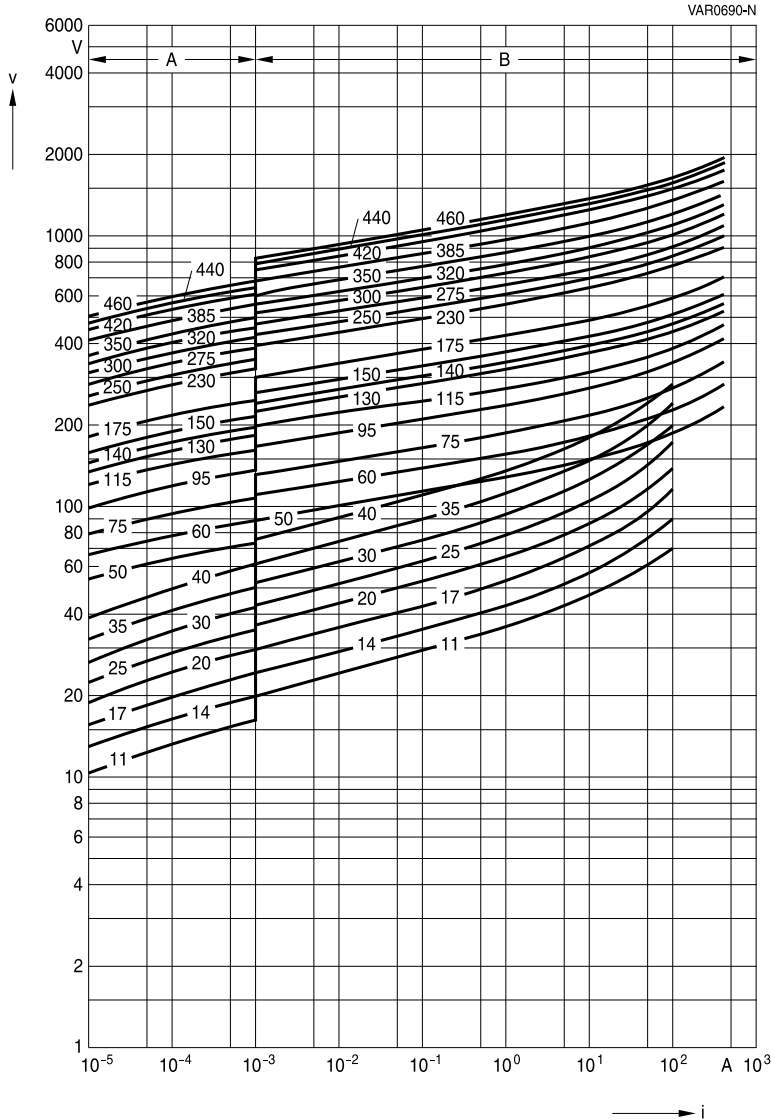

SIOV-S05 ...



v/i characteristics

$v = f(i)$ - for explanation of the characteristics refer to "General technical information", 1.6.3

A = Leakage current, B = Protection level } for worst-case varistor tolerances

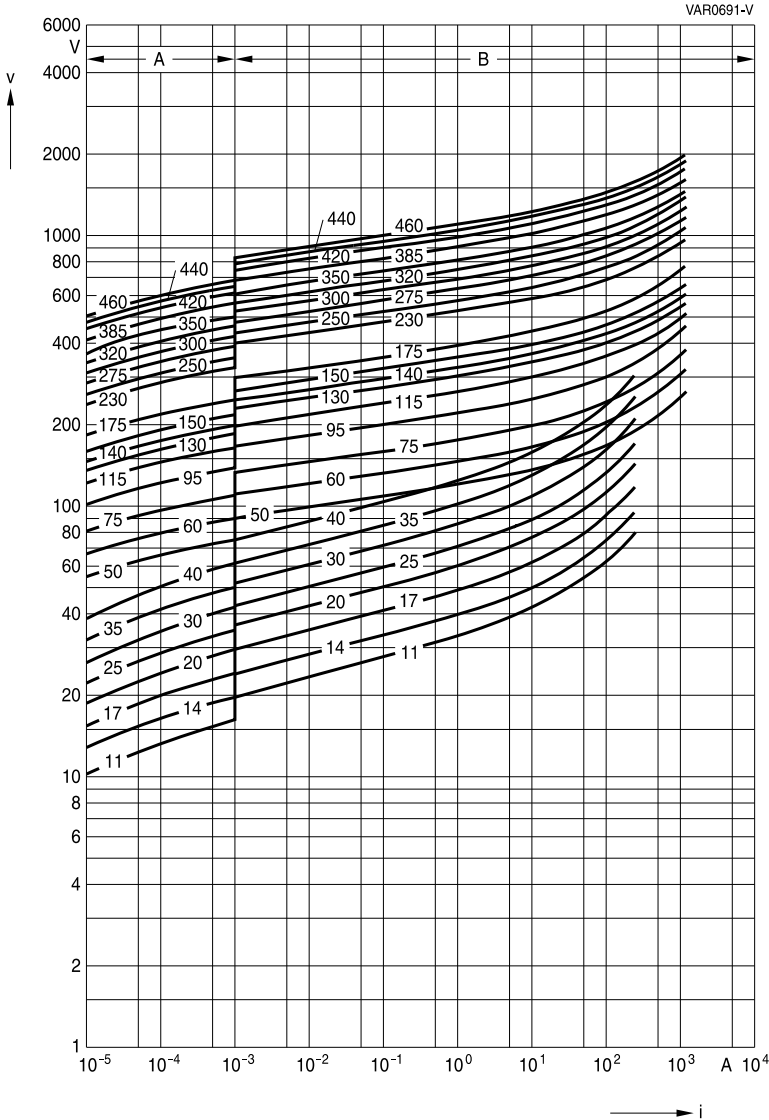

SIOV-S07 ...

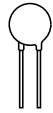

v/i characteristics

$v = f(i)$ - for explanation of the characteristics refer to "General technical information", 1.6.3
 A = Leakage current, B = Protection level } for worst-case varistor tolerances

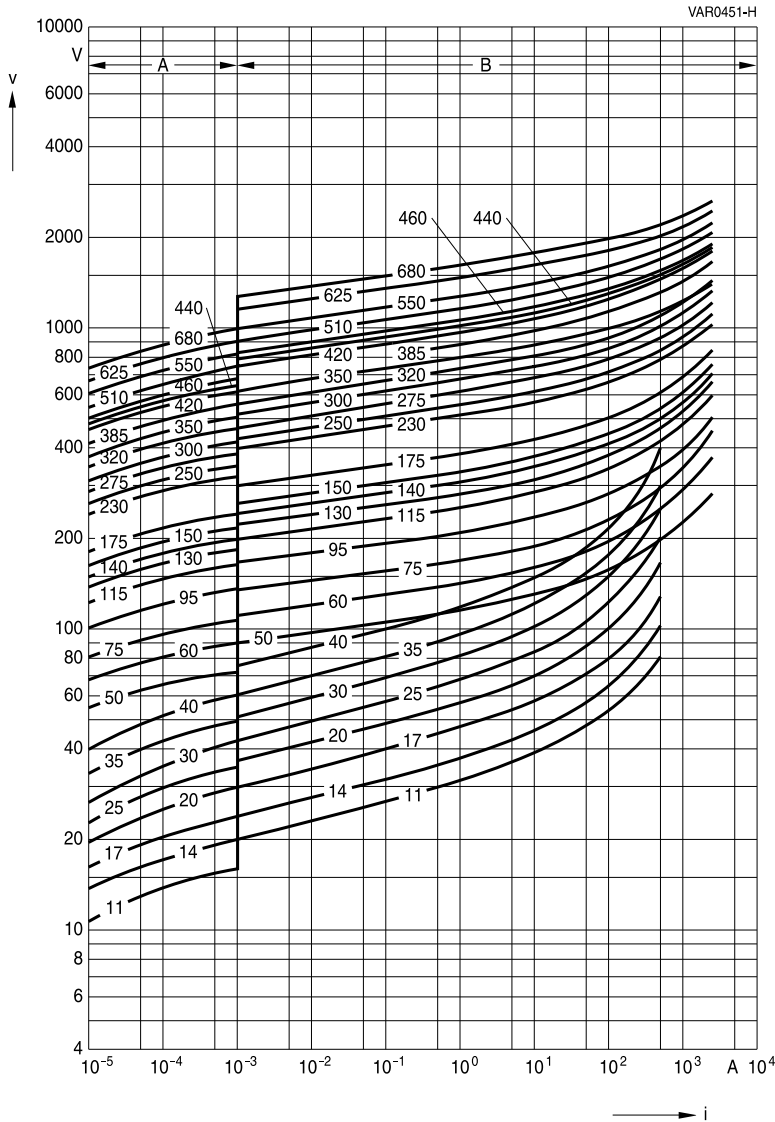

SIOV-S10 ...

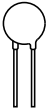

v/i characteristics

$v = f(i)$ - for explanation of the characteristics refer to "General technical information", 1.6.3

A = Leakage current, B = Protection level } for worst-case varistor tolerances

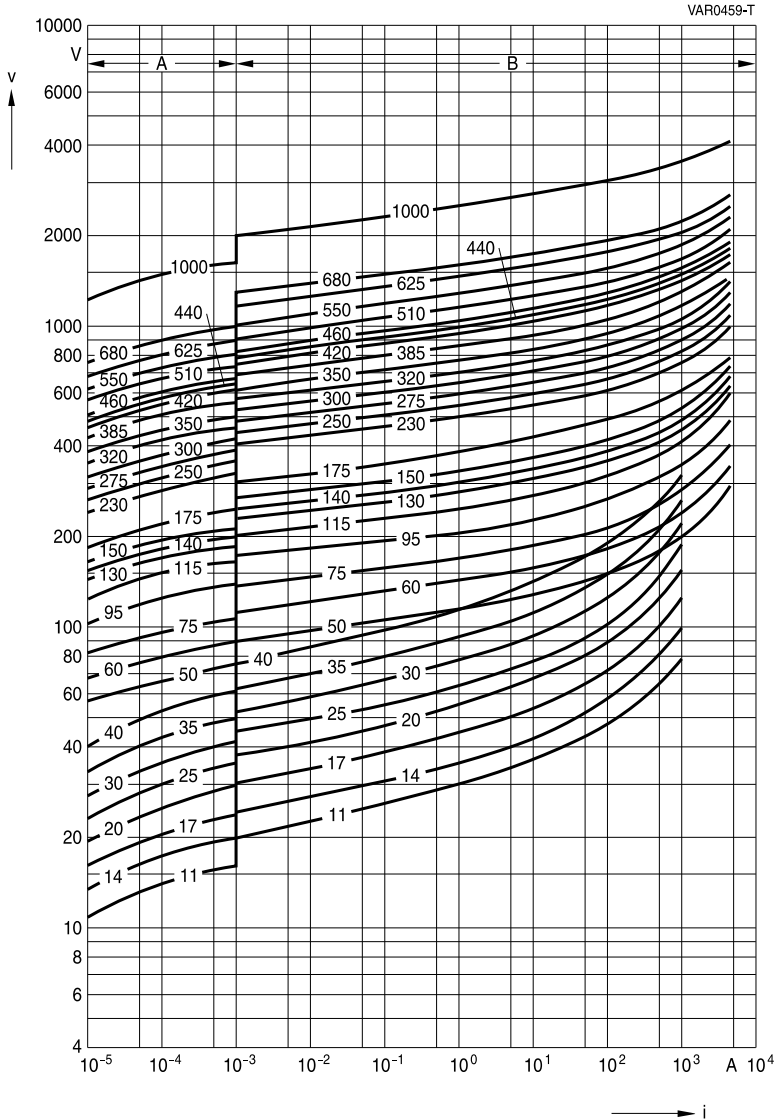

SIOV-S14 ...



v/i characteristics

$v = f(i)$ - for explanation of the characteristics refer to "General technical information", 1.6.3
 A = Leakage current, B = Protection level } for worst-case varistor tolerances

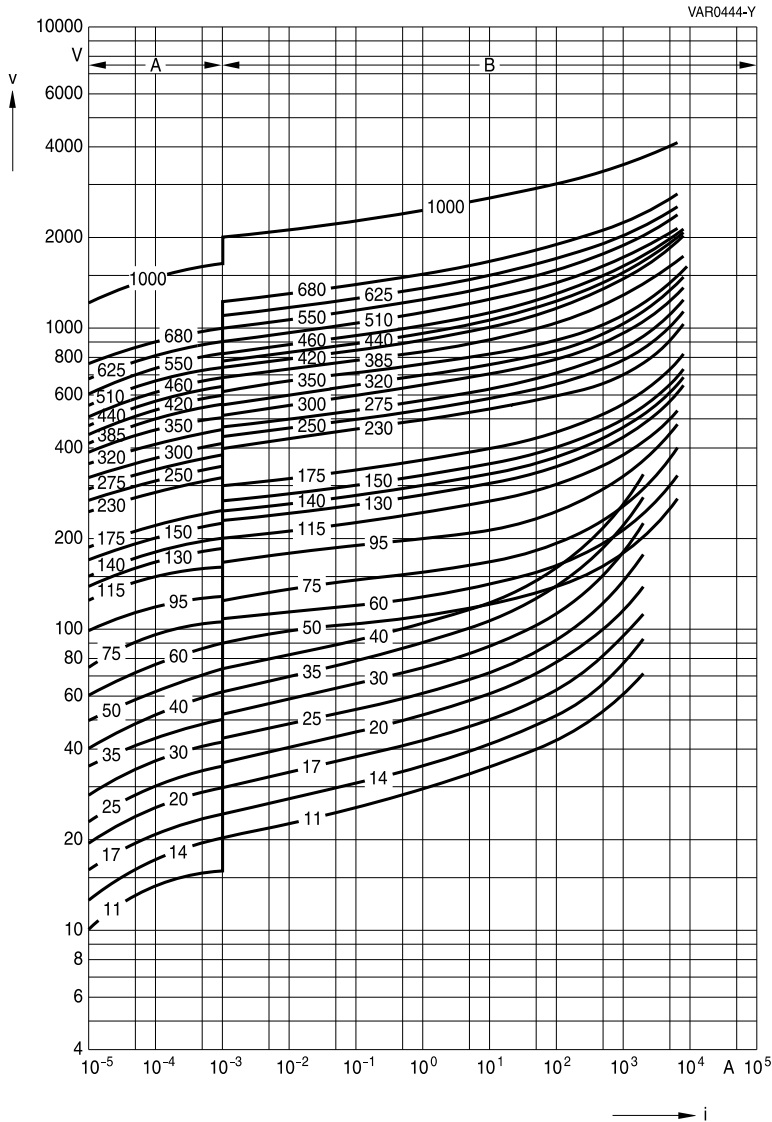

SIOV-S20 ...

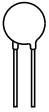

Derating curves

Maximum surge current $i_{max} = f(t_r, \text{pulse train})$

For explanation of the derating curves refer to "General technical information", section 1.8.1

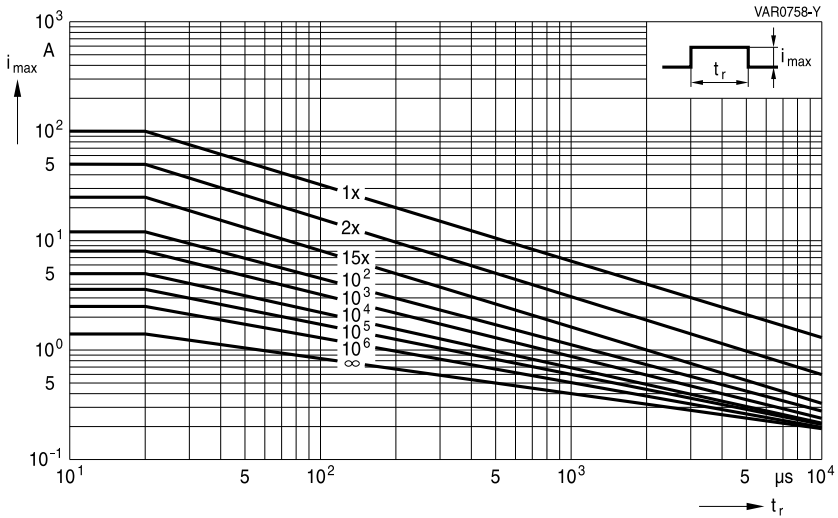

SIOV-S05K11 ... K40

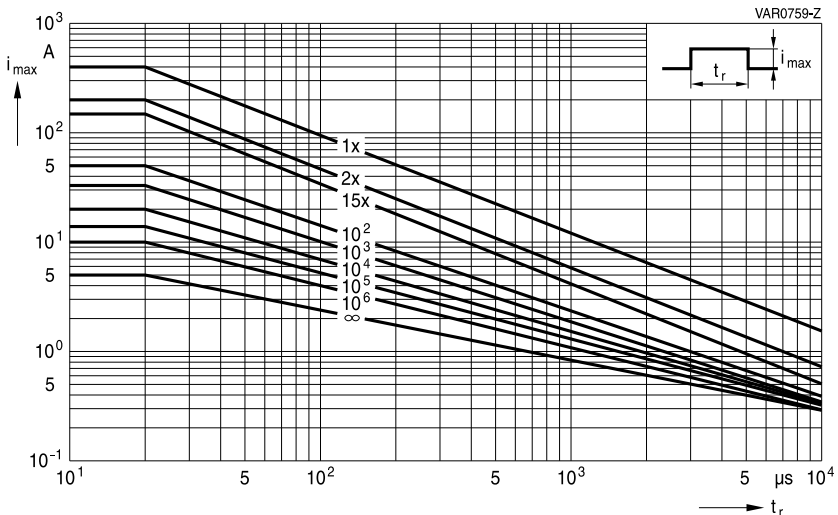

SIOV-S05K50 ... K460

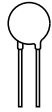

Derating curves

Maximum surge current $i_{max} = f(t_r, \text{pulse train})$

For explanation of the derating curves refer to "General technical information", section 1.8.1

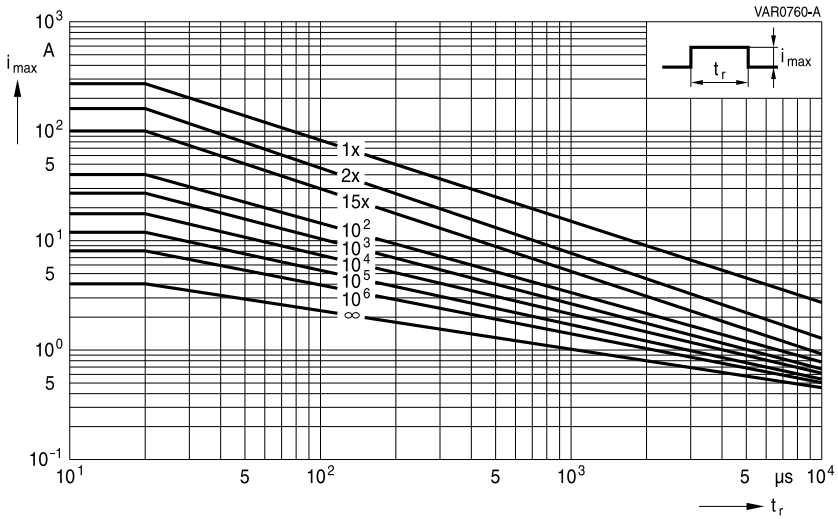

SIOV-S07K11 ... K40

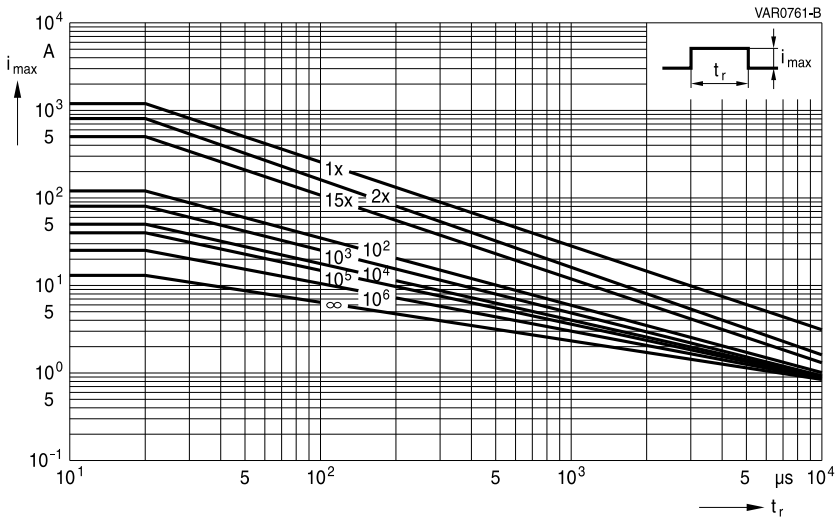

SIOV-S07K50 ... K460

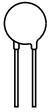

Derating curves

Maximum surge current $i_{max} = f(t_r, \text{pulse train})$

For explanation of the derating curves refer to "General technical information", section 1.8.1

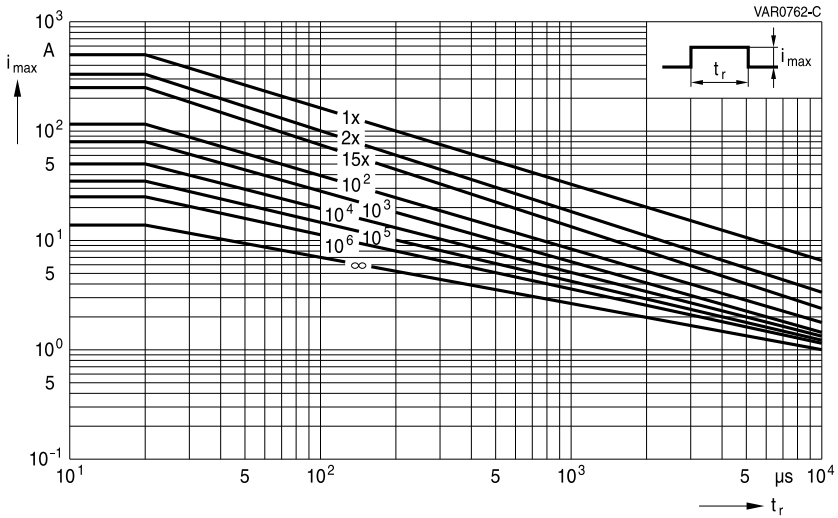

SIOV-S10K11 ... K40

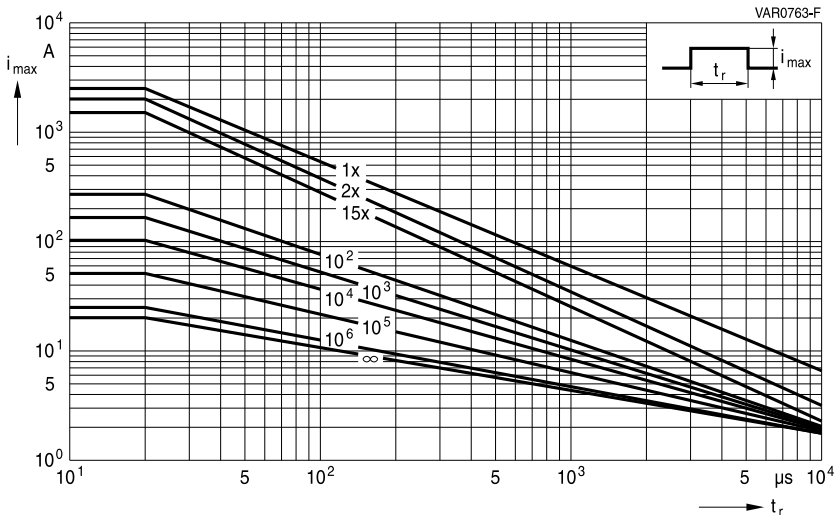

SIOV-S10K50 ... K320

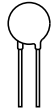

Derating curves

Maximum surge current $i_{max} = f(t_r, \text{pulse train})$

For explanation of the derating curves refer to "General technical information", section 1.8.1

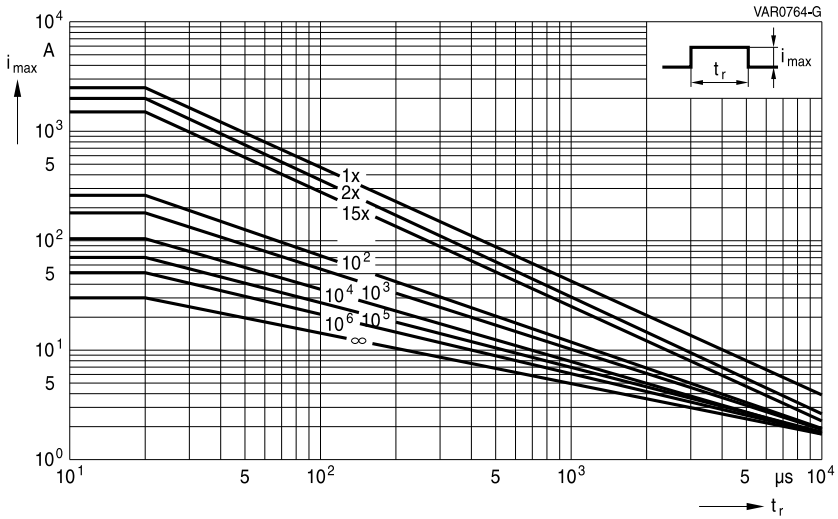

SIOV-S10K350 ... K680

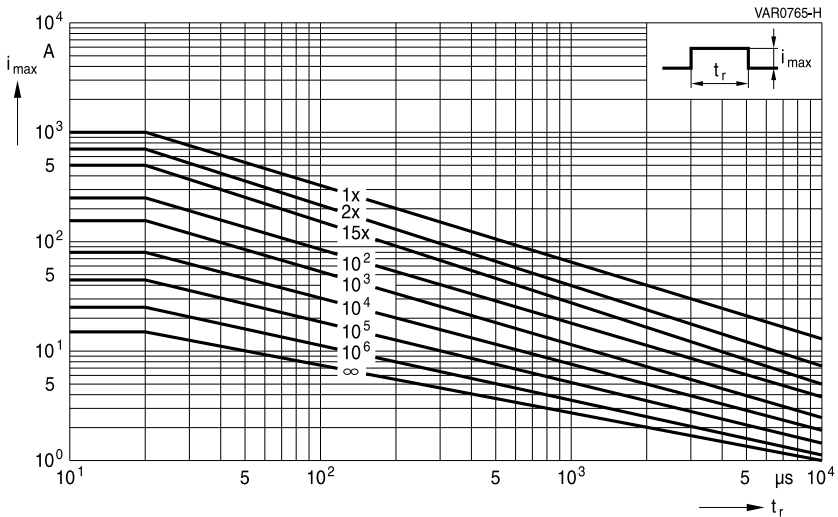

SIOV-S14K11 ... K40

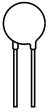

Derating curves

Maximum surge current $i_{max} = f(t_r, \text{pulse train})$

For explanation of the derating curves refer to "General technical information", section 1.8.1

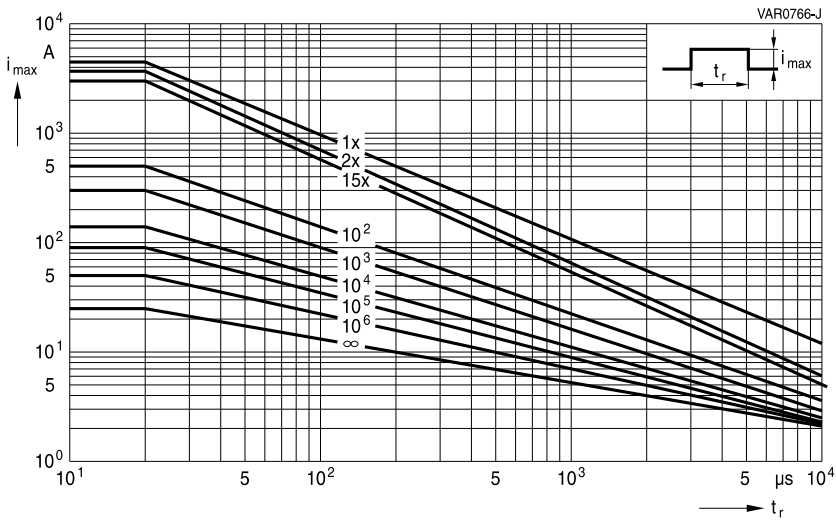

SIOV-S14K50 ... K320

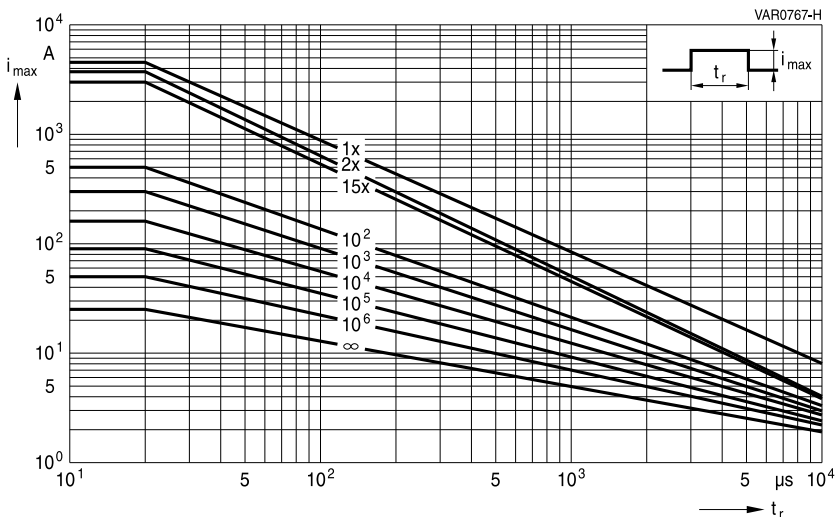

SIOV-S14K350 ... K1000



Derating curves

Maximum surge current $i_{max} = f(t_r, \text{pulse train})$

For explanation of the derating curves refer to "General technical information", section 1.8.1

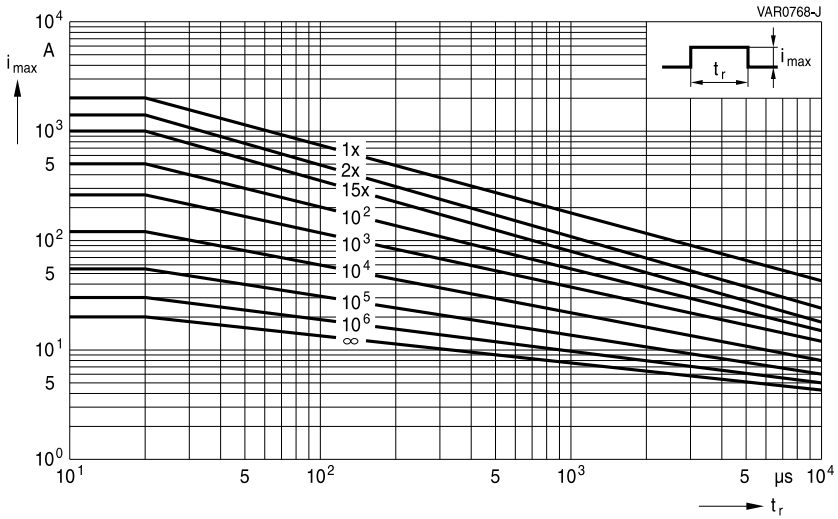

SIOV-S20K11 ... K40

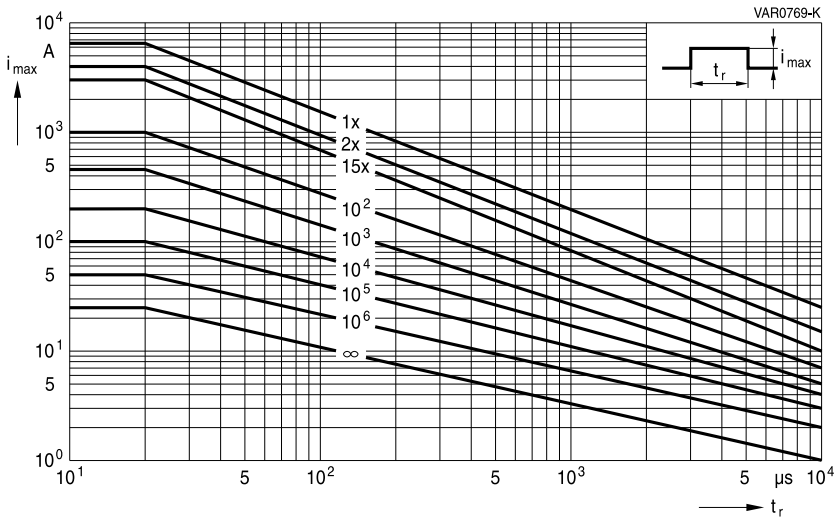

SIOV-S20K50 ... K115

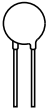

Derating curves

Maximum surge current $i_{max} = f(t_r, \text{pulse train})$

For explanation of the derating curves refer to "General technical information", section 1.8.1

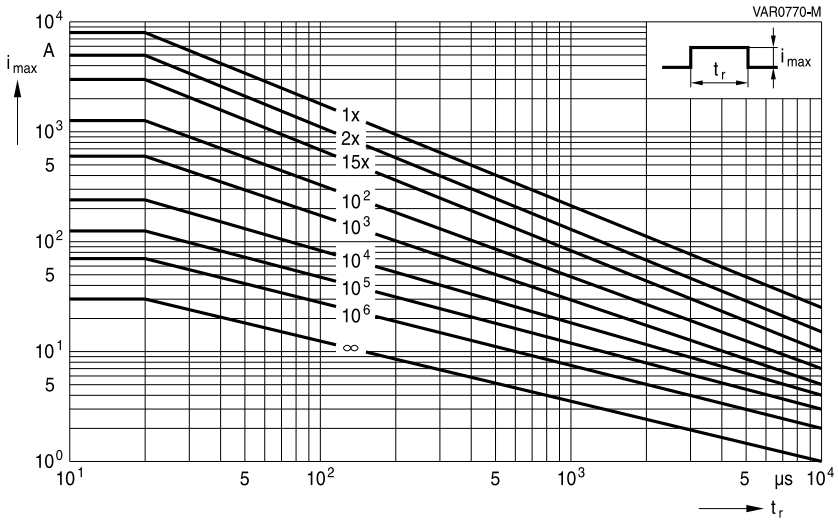

SIOV-S20K130 ... K320

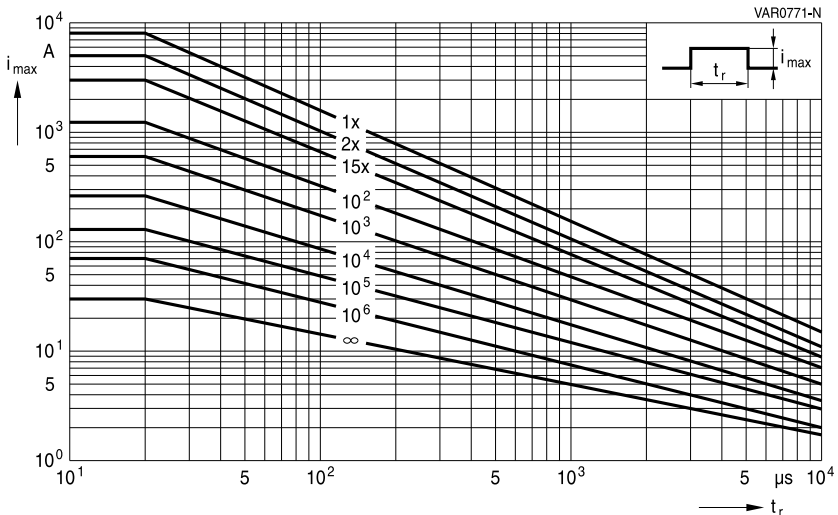

SIOV-S20K350 ... K460



Derating curves

Maximum surge current $i_{max} = f(t_r, \text{pulse train})$

For explanation of the derating curves refer to "General technical information", section 1.8.1

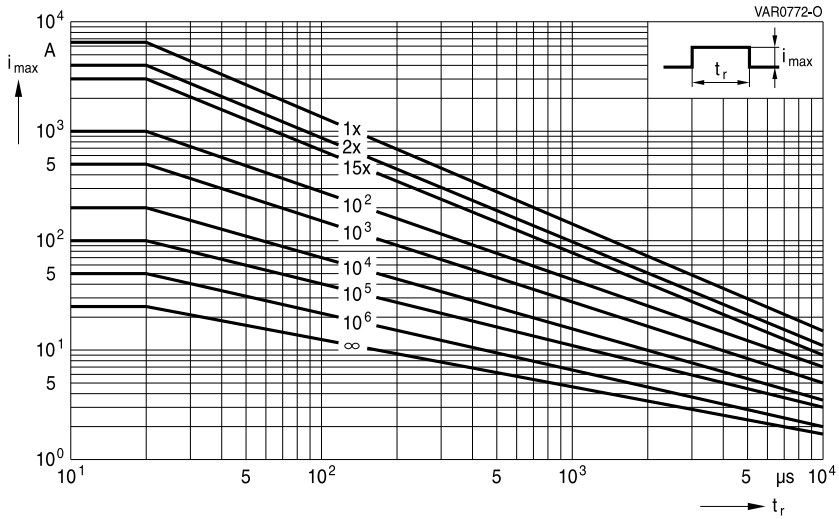

SIOV-S20K510 ... K1000

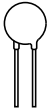

Leaded varistors

B722*

StandarD series

Taping, packaging and lead configuration

1 EPCOS ordering code system

For leaded varistors

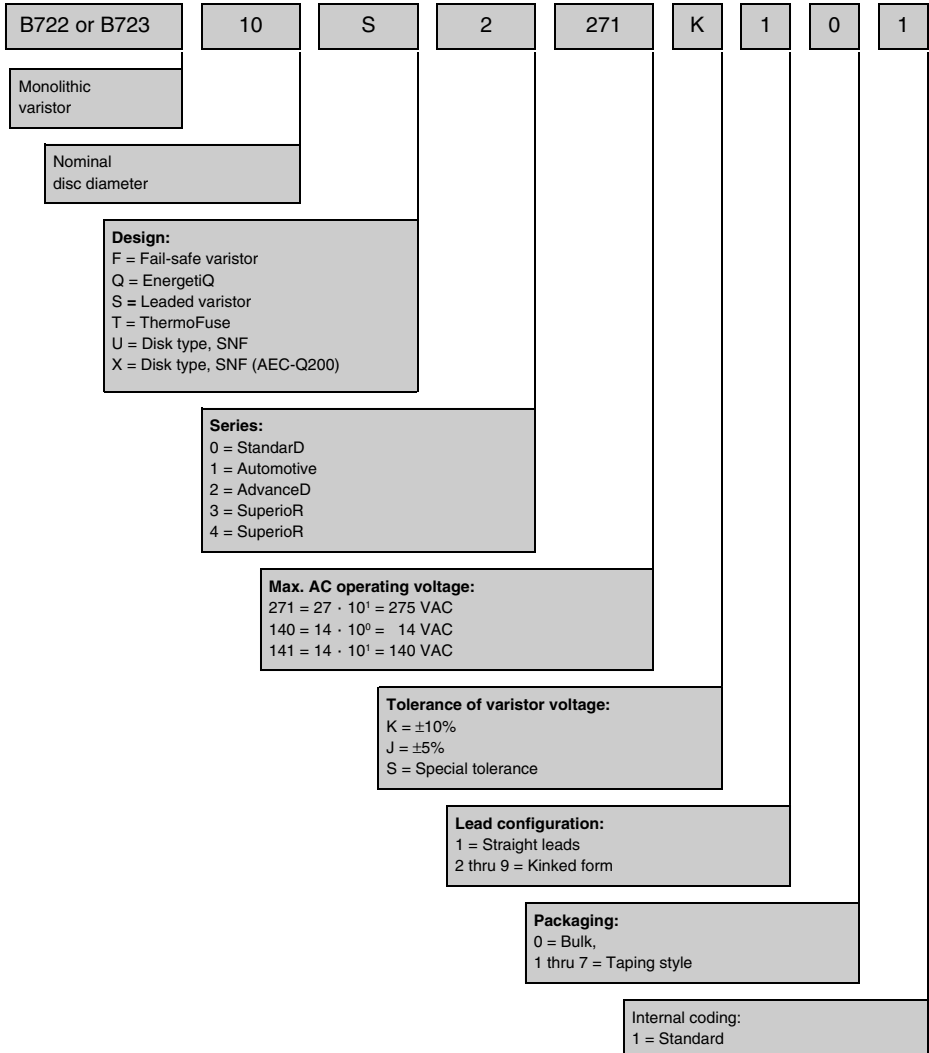



2 Taping and packaging of leaded varistors

Tape packaging for lead spacing $e = 5$ fully conforms to IEC 60286-2, while for lead spacings $e = 7.5$ and 10 the taping mode is based on this standard.

2.1 Taping in accordance with IEC 60286-2 for lead spacing 5.0 mm

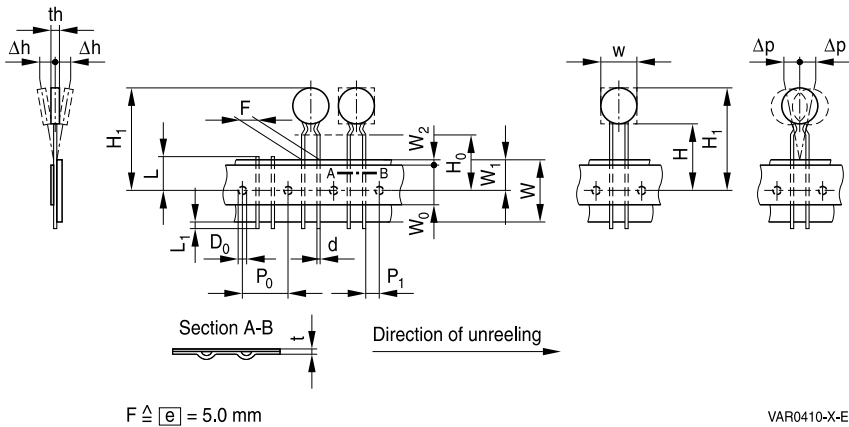

2.2 Taping based on IEC 60286-2 for lead spacing 7.5 and 10 mm

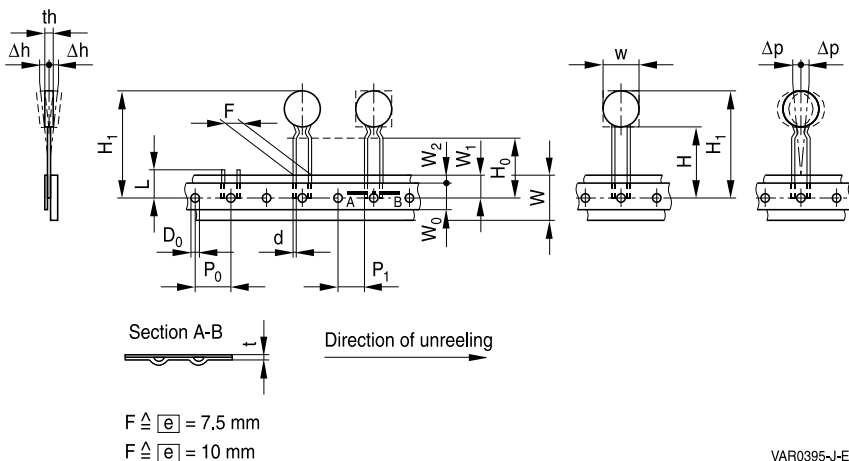

2.3 Tape dimensions (in mm)

| Symbol | $e = 5.0$ | Tolerance | $e = 7.5$ | Tolerance | $e = 10.0$ | Tolerance | Remarks | |
|----------------|----------------|-------------|--------------------|--------------|--------------|--------------|--|---------------|
| w | | max. | | max. | | max. | see tables in each series under "Dimensions" | |
| th | | max. | | max. | | max. | | |
| d | 0.6 | ± 0.05 | 0.8 | ± 0.05 | 1.0 | ± 0.05 | | |
| P ₀ | 12.7 | ± 0.3 | 12.7 ¹⁾ | ± 0.3 | 12.7 | ± 0.3 | ± 1 mm/20 sprocket holes | |
| P ₁ | 3.85 | ± 0.7 | 8.95 | ± 0.8 | 7.7 | ± 0.8 | | |
| F | 5.0 | $+0.6/-0.1$ | 7.5 | ± 0.8 | 10.0 | ± 0.8 | measured at top of component body | |
| Δh | 0 | ± 2.0 | depends on s | | depends on s | | | |
| Δp | 0 | ± 1.3 | 0 | ± 2.0 | 0 | ± 2.0 | | |
| W | 18.0 | ± 0.5 | 18.0 | ± 0.5 | 18.0 | ± 0.5 | Peel-off force ≥ 5 N | |
| W ₀ | 5.5 | min. | 11.0 | min. | 11.0 | min. | | |
| W ₁ | 9.0 | ± 0.5 | 9.0 | $+0.75/-0.5$ | 9.0 | $+0.75/-0.5$ | | |
| W ₂ | 3.0 | max. | 3.0 | max. | 3.0 | max. | | |
| H | 18.0 | $+2.0/-0$ | 18.0 | $+2.0/-0$ | 18.0 | $+2.0/-0$ | ²⁾ | |
| H ₀ | 16.0 (18.0) | ± 0.5 | 16.0 (18.0) | ± 0.5 | 16.0 | ± 0.5 | | ³⁾ |
| H ₁ | 32.2 | max. | 45.0 | max. | 45.0 | max. | | |
| D ₀ | 4.0 | ± 0.2 | 4.0 | ± 0.2 | 4.0 | ± 0.2 | without lead | |
| t | 0.9 | max. | 0.9 | max. | 0.9 | max. | | |
| L | 11.0 | max. | 11.0 | max. | 11.0 | max. | | |
| L ₁ | 0.5 | max. | | | | | | |

1) Taping with P₀ = 15.0 mm upon request

2) Applies only to uncrimped types

3) Applies only to crimped types (H₀ = 18 upon request)



2.4 Taping mode

Example: B72210S0271K1 5 1
|
Digit 14

| Digit 14 | Taping mode | Reel type | Seating plane height H_0 for crimped types mm | Seating plane height H for uncrimped types mm | Pitch distance P_0 mm |
|----------|-------------|-----------|---|---|-------------------------------|
| 0 | — | Bulk | — | — | — |
| 1 | G | I | 16 | 18 | 12.7 |
| 2 | G2 | I | 18 | — | 12.7 |
| 3 | G3 | II | 16 | 18 | 12.7 |
| 4 | G4 | II | 18 | — | 12.7 |
| 5 | G5 | III | 16 | 18 | 12.7 |
| 6 | GA | Ammo pack | 16 | 18 | 12.7 |
| 7 | G2A | Ammo pack | 18 | — | 12.7 |

Internal coding for special taping

| | | | | |
|------|-----------|----|----|------|
| G6 | III | 18 | — | 12.7 |
| G10 | II | 16 | 18 | 15.0 |
| G11 | II | 18 | — | 15.0 |
| G10A | Ammo pack | 16 | 18 | 15.0 |
| G11A | Ammo pack | 18 | — | 15.0 |

2.5 Reel dimension

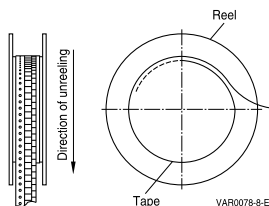
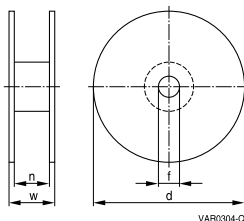

Dimensions (in mm)

| Reel type | d | f | n | w |
|-----------|----------|-------|------------|---------|
| I | 360 max. | 31 ±1 | approx. 45 | 54 max. |
| II | 360 max. | 31 ±1 | approx. 55 | 64 max. |
| III | 500 max. | 23 ±1 | approx. 59 | 72 max. |

If reel type III is not compatible with insertion equipment because of its large diameter, nominal disk diameter 10 mm and 14 mm can be supplied on reel II upon request (taping mode G3).

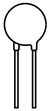

2.6 Ammo pack dimensions

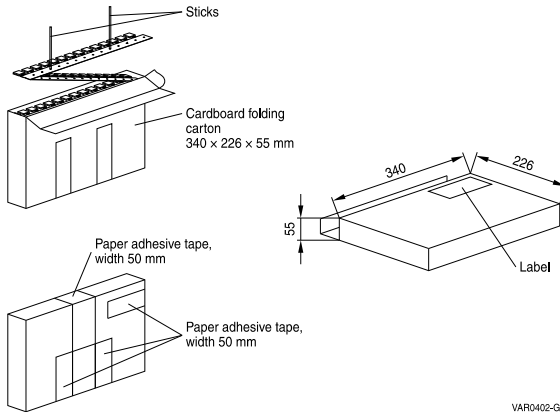

VAR0402-G

3 Lead configuration

Straight leads are standard for disk varistors. Other lead configurations as crimp style or customer-specific lead wire length according to 3.1, 3.2, 3.3 and 3.4 are optional. Crimped leads (non-standard) are differently crimped for technical reasons; the individual crimp styles are denoted by consecutive numbers (S, S2 through S5) as shown in the dimensional drawings below.

The crimp styles of the individual types can be seen from the type designation in the ordering tables.

3.1 Crimp style mode

Example: B72210S0271K **5** 01

Digit 13

| Digit 13 of ordering code | Crimp style | Figure |
|---------------------------|--------------------------|--------|
| 1 | Standard, straight leads | 1 |
| 2 | S2 | 2 |
| 3 | S3 | 3 |
| 5 | S5 | 4 |
| Available upon request | | |
| Internal coding | — | 5 |



3.2 Standard leads and non-standard crimp styles

The basic dimensions in figure 1 to 5 are valid for types with either round or square (EnergetiQ series) component head.

Standard, straight leads

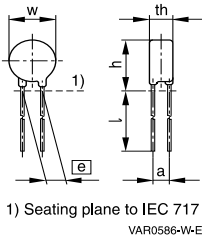

Figure 1

Non-standard, crimp style S2

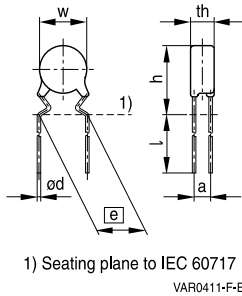

Figure 2

Non-standard, crimp style S3

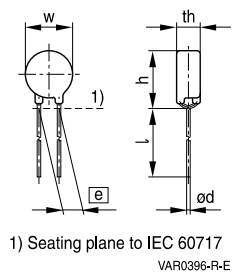

Figure 3

Non-standard, crimp style S5

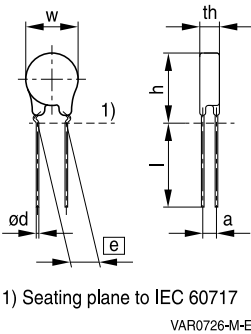

Figure 4



3.3 Trimmed leads (non-standard)

Varistors with cut leads available upon request.

Lead length tolerances:

Straight leads ± 0.8 mm

Crimped leads ± 0.5 mm

Minimum lead length 3.0 mm

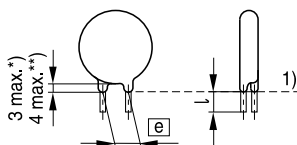

1) Seating plane to IEC 60717

*) For round component head

***) For EnergetiQ series, square component head

VAR0642-U-E

Figure 5



Cautions and warnings

General

1. EPCOS metal oxide varistors are designed for specific applications and should not be used for purposes not identified in our specifications, application notes and data books unless otherwise agreed with EPCOS during the design-in-phase.
2. Ensure suitability of SIOVs through reliability testing during the design-in phase. SIOVs should be evaluated taking into consideration worst-case conditions.
3. For applications of SIOVs in line-to-ground circuits based on various international and local standards there are restrictions existing or additional safety measures required.

Storage

1. Store SIOVs only in original packaging. Do not open the package prior to processing.
2. Recommended storage conditions in original packaging:
 Storage temperature: $-25\text{ °C} \dots +45\text{ °C}$,
 Relative humidity: $<75\%$ annual average,
 $<95\%$ on maximum 30 days a year.
 Dew precipitation: is to be avoided.
3. Avoid contamination of an SIOV's during storage, handling and processing.
4. Avoid storage of SIOVs in harmful environments that can affect the function during long-term operation (examples given under operation precautions).
5. The SIOV type series should be soldered after shipment from EPCOS within the time specified:

| | |
|---------------------------|------------|
| SIOV-S, -Q, -LS, -B, -SNF | 24 months |
| ETFV/ T series, -CU | 12 months. |

Handling

1. SIOVs must not be dropped.
2. Components must not be touched with bare hands. Gloves are recommended.
3. Avoid contamination of the surface of SIOV electrodes during handling, be careful of the sharp edge of SIOV electrodes.

Soldering (where applicable)

1. Use rosin-type flux or non-activated flux.
2. Insufficient preheating may cause ceramic cracks.
3. Rapid cooling by dipping in solvent is not recommended.
4. Complete removal of flux is recommended.
5. Temperatures of all preheat stages and the solder bath must be strictly controlled especially for T series (T14 and T20).



Mounting

1. Potting, sealing or adhesive compounds can produce chemical reactions in the SIOV ceramic that will degrade the component's electrical characteristics.
2. Overloading SIOVs may result in ruptured packages and expulsion of hot materials. For this reason SIOVs should be physically shielded from adjacent components.

Operation

1. Use SIOVs only within the specified temperature operating range.
2. Use SIOVs only within the specified voltage and current ranges.
3. Environmental conditions must not harm SIOVs. Use SIOVs only in normal atmospheric conditions. Avoid use in deoxidizing gases (chlorine gas, hydrogen sulfide gas, ammonia gas, sulfuric acid gas etc), corrosive agents, humid or salty conditions. Contact with any liquids and solvents should be prevented.

Display of ordering codes for EPCOS products

The ordering code for one and the same EPCOS product can be represented differently in data sheets, data books, other publications, on the EPCOS website, or in order-related documents such as shipping notes, order confirmations and product labels. **The varying representations of the ordering codes are due to different processes employed and do not affect the specifications of the respective products.** Detailed information can be found on the Internet under www.epcos.com/orderingcodes

Symbols and terms

| Symbol | Term |
|--------------------|--|
| C | Capacitance |
| C_{typ} | Typical capacitance |
| i | Current |
| i_c | Current at which $V_{c, max}$ is measured |
| I_{leak} | Leakage current |
| i_{max} | Maximum surge current (also termed peak current) |
| I_{max} | Maximum discharge current |
| I_n | Nominal discharge current to UL 1449 |
| LCT | Lower category temperature |
| L_{typ} | Typical inductance |
| P_{max} | Maximum average power dissipation |
| R_{ins} | Insulation resistance |
| R_{min} | Minimum resistance |
| T_A | Ambient temperature |
| t_r | Duration of equivalent rectangular wave |
| UCT | Upper category temperature |
| v | Voltage |
| V_{clamp} | Clamping voltage |
| $V_{c, max}$ | Maximum clamping voltage at specified current i_c |
| V_{DC} | DC operating voltage |
| V_{jump} | Maximum jump start voltage |
| V_{max} | Maximum voltage |
| V_{op} | Operating voltage |
| V_{RMS} | AC operating voltage, root-mean-square value |
| $V_{RMS, op, max}$ | Root-mean-square value of max. DC operating voltage incl. ripple current |
| V_{surge} | Super imposed surge voltage |
| V_V | Varistor voltage |
| ΔV_V | Tolerance of varistor voltage |
| W_{LD} | Maximum load dump |
| W_{max} | Maximum energy absorption |
| e | Lead spacing |

All dimensions are given in mm.

The commas used in numerical values denote decimal points.

Important notes

The following applies to all products named in this publication:

1. Some parts of this publication contain **statements about the suitability of our products for certain areas of application**. These statements are based on our knowledge of typical requirements that are often placed on our products in the areas of application concerned. We nevertheless expressly point out **that such statements cannot be regarded as binding statements about the suitability of our products for a particular customer application**. As a rule we are either unfamiliar with individual customer applications or less familiar with them than the customers themselves. For these reasons, it is always ultimately incumbent on the customer to check and decide whether a product with the properties described in the product specification is suitable for use in a particular customer application.
2. We also point out that **in individual cases, a malfunction of electronic components or failure before the end of their usual service life cannot be completely ruled out in the current state of the art, even if they are operated as specified**. In customer applications requiring a very high level of operational safety and especially in customer applications in which the malfunction or failure of an electronic component could endanger human life or health (e.g. in accident prevention or life-saving systems), it must therefore be ensured by means of suitable design of the customer application or other action taken by the customer (e.g. installation of protective circuitry or redundancy) that no injury or damage is sustained by third parties in the event of malfunction or failure of an electronic component.
3. **The warnings, cautions and product-specific notes must be observed.**
4. In order to satisfy certain technical requirements, **some of the products described in this publication may contain substances subject to restrictions in certain jurisdictions (e.g. because they are classed as hazardous)**. Useful information on this will be found in our Material Data Sheets on the Internet (www.tdk-electronics.tdk.com/material). Should you have any more detailed questions, please contact our sales offices.
5. We constantly strive to improve our products. Consequently, **the products described in this publication may change from time to time**. The same is true of the corresponding product specifications. Please check therefore to what extent product descriptions and specifications contained in this publication are still applicable before or when you place an order.

We also **reserve the right to discontinue production and delivery of products**. Consequently, we cannot guarantee that all products named in this publication will always be available. The aforementioned does not apply in the case of individual agreements deviating from the foregoing for customer-specific products.
6. Unless otherwise agreed in individual contracts, **all orders are subject to our General Terms and Conditions of Supply**.
7. **Our manufacturing sites serving the automotive business apply the IATF 16949 standard**. The IATF certifications confirm our compliance with requirements regarding the quality management system in the automotive industry. Referring to customer requirements and customer specific requirements ("CSR") TDK always has and will continue to have the policy of respecting individual agreements. Even if IATF 16949 may appear to support the acceptance of unilateral requirements, we hereby like to emphasize that **only requirements mutually agreed upon can and will be implemented in our Quality Management System**. For clarification purposes we like to point out that obligations from IATF 16949 shall only become legally binding if individually agreed upon.

Important notes

8. The trade names EPCOS, CeraCharge, CeraDiode, CeraLink, CeraPad, CeraPlas, CSMP, CTVS, DeltaCap, DigiSiMic, ExoCore, FilterCap, FormFit, LeaXield, MiniBlue, MiniCell, MKD, MKK, MotorCap, PCC, PhaseCap, PhaseCube, PhaseMod, PhiCap, PowerHap, PQSine, PQvar, SIFERRIT, SIFI, SIKOREL, SilverCap, SIMDAD, SiMic, SIMID, SineFormer, SIOV, ThermoFuse, WindCap are **trademarks registered or pending** in Europe and in other countries. Further information will be found on the Internet at www.tdk-electronics.tdk.com/trademarks.

Release 2018-10