

# LXA08T600C

## Qspeed™ Family



600 V, 8 A X-Series Common-Cathode Diode

### Product Summary

$I_{F(AVG)}$ per diode	4	A
$V_{RRM}$	600	V
$Q_{RR}$ (Typ at 125 °C)	50	nC
$I_{RRM}$ (Typ at 125 °C)	2.6	A
Softness $t_b/t_a$ (Typ at 125 °C)	0.8	

### Pin Assignment

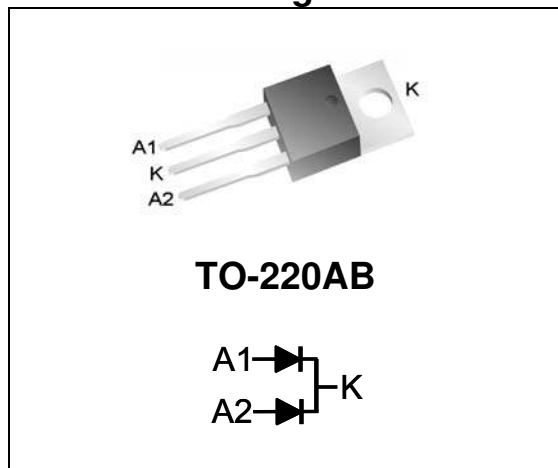

### RoHS Compliant

Package uses Lead-free plating and Green mold compound.  
Halogen free per IEC 61249-2-21.

### General Description

This device has the lowest  $Q_{RR}$  of any 600 V Silicon diode. Its recovery characteristics increase efficiency, reduce EMI and eliminate snubbers.

### Applications

- Power Factor Correction (PFC) Boost Diode
- Motor drive circuits
- DC-AC inverters

### Features

- Low  $Q_{RR}$ , Low  $I_{RRM}$ , Low  $t_{RR}$
- High  $dI_F/dt$  capable (1000 A/ $\mu$ s)
- Soft recovery

### Benefits

- Increases efficiency
  - Eliminates need for snubber circuits
  - Reduces EMI filter component size & count
- Enables extremely fast switching

### Absolute Maximum Ratings

Absolute maximum ratings are the values beyond which the device may be damaged or have its useful life impaired. Functional operation under these conditions is not implied.

Symbol	Parameter	Conditions	Rating	Units
$V_{RRM}$	Peak repetitive reverse voltage		600	V
$I_{F(AVG)}$	Average forward current	Per Diode, $T_J = 150\text{ °C}$ , $T_C = 127\text{ °C}$	4	A
		Per Device, $T_J = 150\text{ °C}$ , $T_C = 127\text{ °C}$	8	A
$I_{FSM}$	Non-repetitive peak surge current	60 Hz, ½ cycle	30	A
$I_{FSM}$	Non-repetitive peak surge current	½ cycle of $t = 28\ \mu\text{s}$ Sinusoid, $T_C = 25\text{ °C}$	350	A
$T_J$	Maximum junction temperature		150	°C
$T_{STG}$	Storage temperature		-55 to 150	°C
	Lead soldering temperature	Leads at 1.6mm from case, 10 sec	300	°C

### Thermal Resistance

Symbol	Resistance from:	Conditions	Rating	Units
$R_{\theta JA}$	Junction to ambient	TO-220AB	62	°C/W
$R_{\theta JC}$	Junction to case	Per Diode	2.4	°C/W
		Per Device	1.2	°C/W

## Electrical Specifications at $T_J = 25\text{ }^\circ\text{C}$ (unless otherwise specified)

Symbol	Parameter	Conditions	Min	Typ	Max	Units	
<b>DC Characteristics</b>							
$I_R$	Reverse current per diode	$V_R = 600\text{ V}, T_J = 25\text{ }^\circ\text{C}$	-	-	250	$\mu\text{A}$	
		$V_R = 600\text{ V}, T_J = 125\text{ }^\circ\text{C}$	-	0.45	-	$\text{mA}$	
$V_F$	Forward voltage per diode	$I_F = 4\text{ A}, T_J = 25\text{ }^\circ\text{C}$	-	2.42	2.96	$\text{V}$	
		$I_F = 4\text{ A}, T_J = 150\text{ }^\circ\text{C}$	-	2.10	-	$\text{V}$	
$C_J$	Junction capacitance per diode	$V_R = 10\text{ V}, 1\text{ MHz}$	-	21	-	$\text{pF}$	
<b>Dynamic Characteristics</b>							
$t_{RR}$	Reverse recovery time, per diode	$di_F/dt = 200\text{ A}/\mu\text{s}$ $V_R = 400, I_F = 4\text{ A}$	$T_J = 25\text{ }^\circ\text{C}$	-	18.5	-	$\text{ns}$
			$T_J = 125\text{ }^\circ\text{C}$	-	27.5	-	$\text{ns}$
$Q_{RR}$	Reverse recovery charge, per diode	$di_F/dt = 200\text{ A}/\mu\text{s}$ $V_R = 400, I_F = 4\text{ A}$	$T_J = 25\text{ }^\circ\text{C}$	-	21.1	29.0	$\text{nC}$
			$T_J = 125\text{ }^\circ\text{C}$	-	50	-	$\text{nC}$
$I_{RRM}$	Maximum reverse recovery current, per diode	$di_F/dt = 200\text{ A}/\mu\text{s}$ $V_R = 400, I_F = 4\text{ A}$	$T_J = 25\text{ }^\circ\text{C}$	-	1.75	2.3	$\text{A}$
			$T_J = 125\text{ }^\circ\text{C}$	-	2.6	-	$\text{A}$
S	Softness per diode = $\frac{t_b}{t_a}$	$di_F/dt = 200\text{ A}/\mu\text{s}$ $V_R = 400, I_F = 4\text{ A}$	$T_J = 25\text{ }^\circ\text{C}$	-	0.8	-	
			$T_J = 125\text{ }^\circ\text{C}$	-	0.8	-	

**Note to component engineers:** X-Series diodes employ Schottky technologies in their design and construction. Therefore, component engineers should plan their test setups to be similar to traditional Schottky test setups. (For further details, see application note AN-300.)

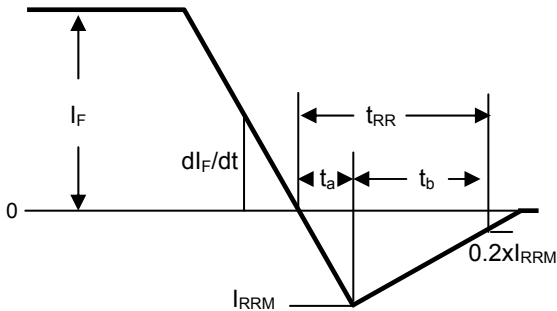

Figure 1. Reverse Recovery Definitions

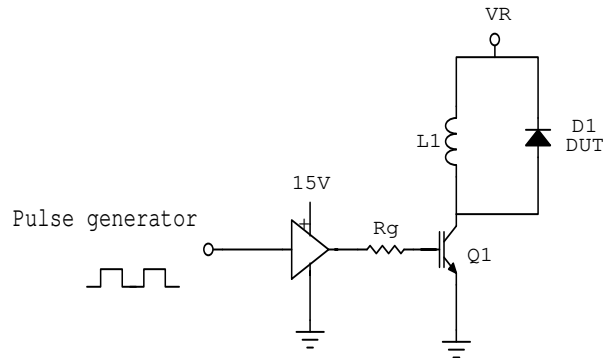
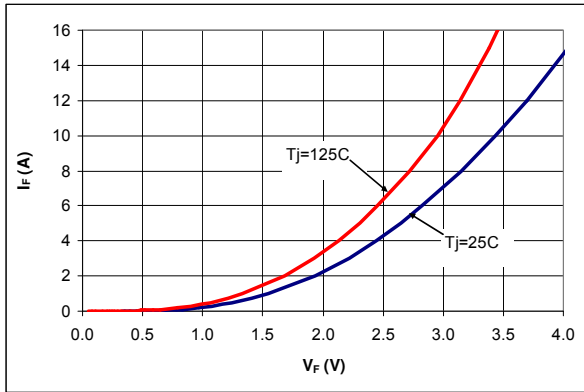
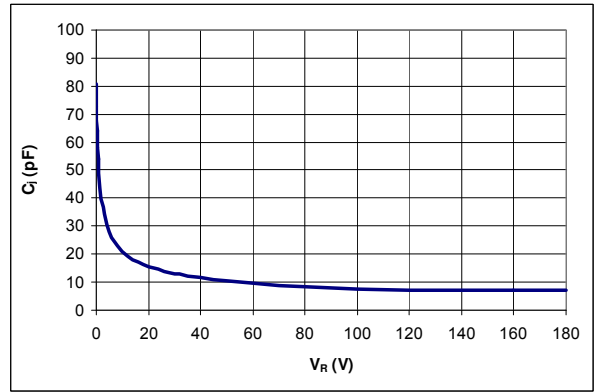

Figure 2. Reverse Recovery Test Circuit

**Electrical Specifications at  $T_J = 25\text{ }^\circ\text{C}$  (unless otherwise specified)**



**Figure 3. Typical  $I_F$  vs  $V_F$**



**Figure 4. Typical  $C_j$  vs  $V_R$**

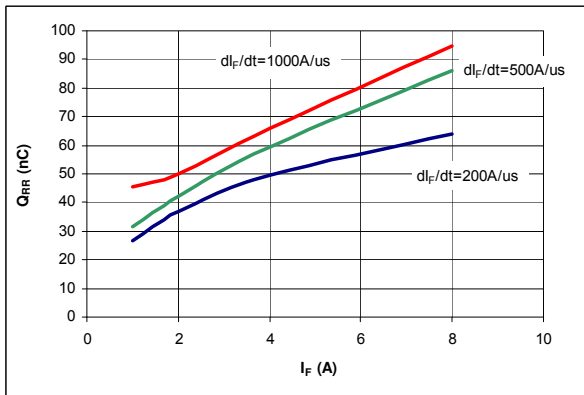

**Figure 5. Typical  $Q_{RR}$  vs  $I_F$  at  $T_J = 125\text{ }^\circ\text{C}$**

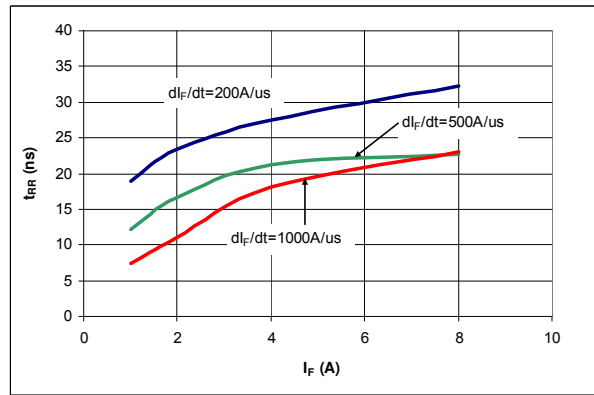

**Figure 6. Typical  $t_{RR}$  vs  $I_F$  at  $T_J = 125\text{ }^\circ\text{C}$**

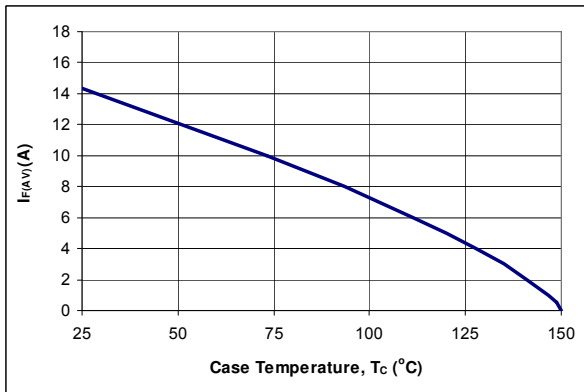

**Figure 7. DC Current Derating Curve**

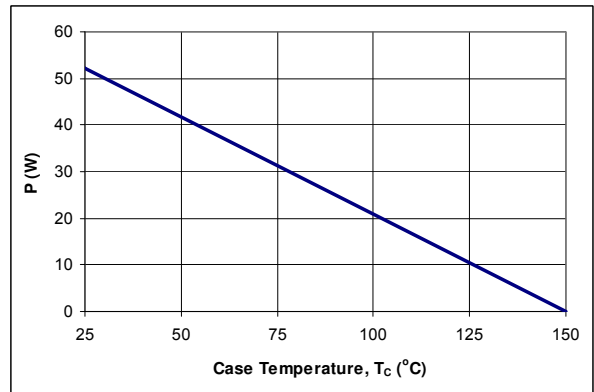

**Figure 8. Power Derating Curve**

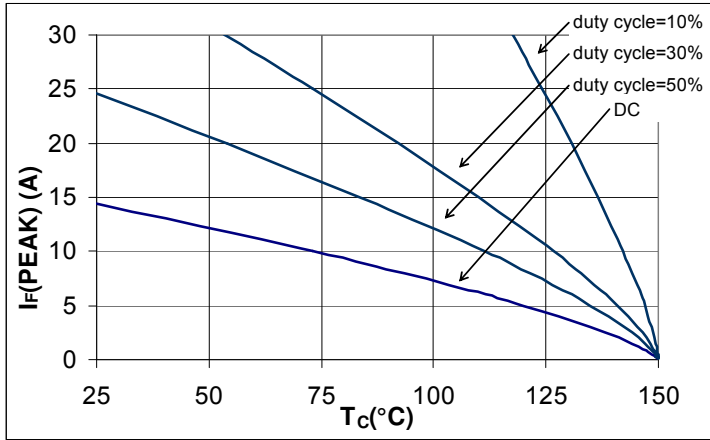

Figure 9.  $I_f(\text{Peak})$  vs  $T_c$ ,  $f=70$  kHz

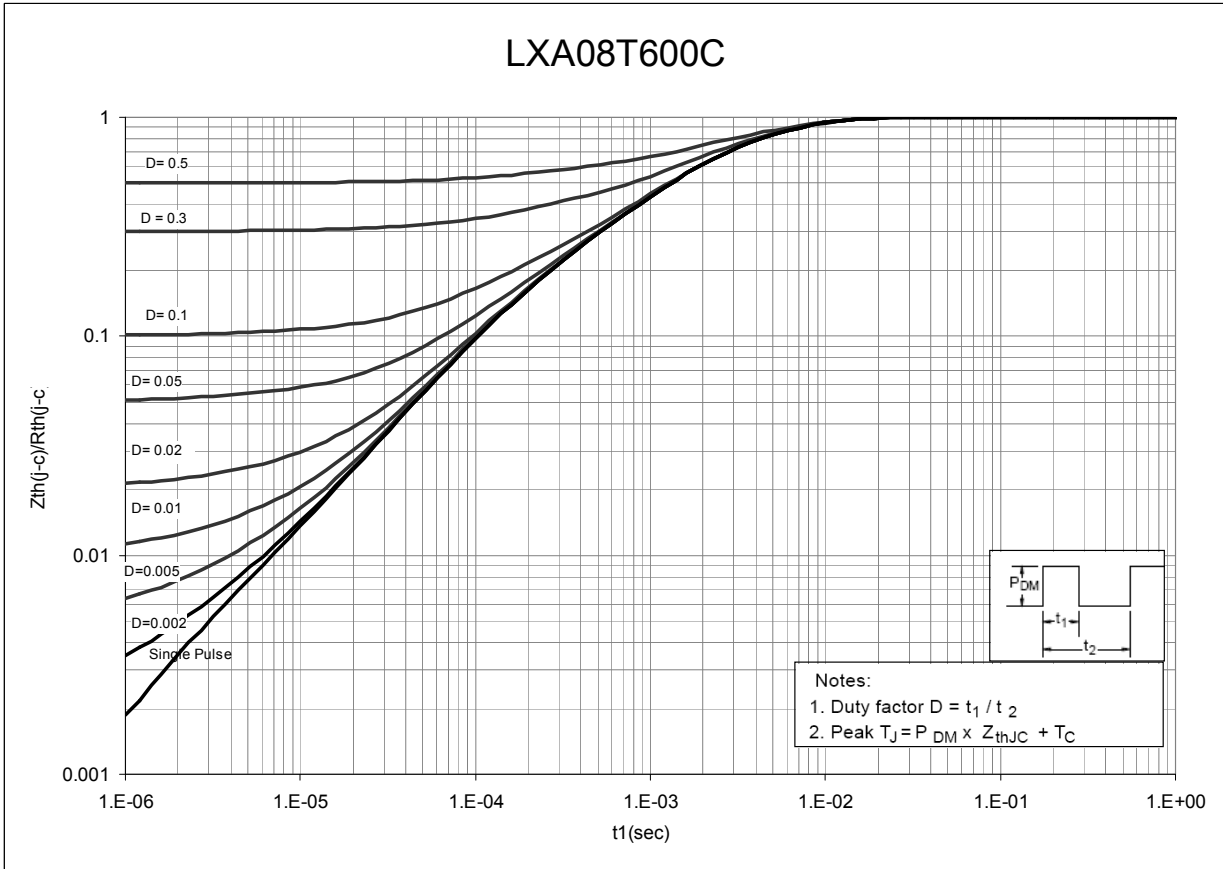
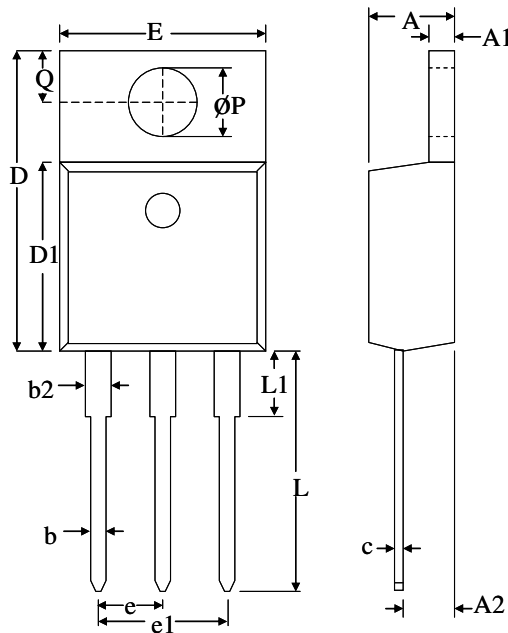

Figure 10. Normalized Maximum Transient Thermal Impedance

**Dimensional Outline Drawings**

TO-220AB



Dim	Millimeters	
	MIN	MAX
A	4.32	4.70
A1	1.11	1.38
A2	2.59	2.79
b	0.77	1.00
b2	1.23	1.36
C	0.34	0.47
D	14.71	15.75
D1	9.05	9.25
E	9.96	10.36
e	2.44	2.64
e1	4.98	5.18
L	12.70	14.22
L1	-	3.90
ØP	3.71	3.96
Q	2.54	2.90

Mechanical Mounting Method	Maximum Torque / Pressure specification
Screw through hole in package tab	1 Newton Meter (nm) or 8.8 inch-pounds (lb-in)
Clamp against package body	12.3 kilogram-force per square centimeter (kgf/cm <sup>2</sup> ) or 175 lbf/in <sup>2</sup>

**Soldering time and temperature:** This product has been designed for use with high-temperature, lead-free solder. The component leads can be subjected to a maximum temperature of 300 °C, for up to 10 seconds. See Application Note AN-303, for more details.

**Ordering Information**

Part Number	Package	Packing
LXA08T600C	TO-220AB	50 units/tube

The information contained in this document is subject to change without notice.

# LXA08T600C

---

Revision	Notes	Date
1.0	Released by Qspeed	06/10
1.1	Converted to Power Integrations document	01/11
1.1	Stop Point of $t_{RR}$ error corrected due to typo in Figure 1	11/13

**For the latest updates, visit our website: [www.powerint.com](http://www.powerint.com)**

Power Integrations reserves the right to make changes to its products at any time to improve reliability or manufacturability. Power Integrations does not assume any liability arising from the use of any device or circuit described herein. POWER INTEGRATIONS MAKES NO WARRANTY HEREIN AND SPECIFICALLY DISCLAIMS ALL WARRANTIES INCLUDING, WITHOUT LIMITATION, THE IMPLIED WARRANTIES OF MERCHANTABILITY, FITNESS FOR A PARTICULAR PURPOSE, AND NON-INFRINGEMENT OF THIRD PARTY RIGHTS.

**PATENT INFORMATION**

The products and applications illustrated herein (including transformer construction and circuits' external to the products) may be covered by one or more U.S. and foreign patents, or potentially by pending U.S. and foreign patent applications assigned to Power Integrations. A complete list of Power Integrations' patents may be found at [www.powerint.com](http://www.powerint.com). Power Integrations grants its customers a license under certain patent rights as set forth at <http://www.powerint.com/ip.htm>.

The PI Logo, TOPSwitch, TinySwitch, LinkSwitch, LYTSwitch, DPA-Switch, PeakSwitch, CAPZero, SENZero, LinkZero, HiperPFS, HiperTFS, HiperLCS, Qspeed, EcoSmart, Clampless, E-Shield, Filterfuse, StackFET, PI Expert and PI FACTS are trademarks of Power Integrations, Inc. Other trademarks are property of their respective companies. ©Copyright 2013 Power Integrations, Inc.

**Power Integrations Worldwide Sales Support Locations****WORLD HEADQUARTERS**

5245 Hellyer Avenue  
San Jose, CA 95138, USA.  
Main: +1-408-414-9200  
Customer Service:  
Phone: +1-408-414-9665  
Fax: +1-408-414-9765  
*e-mail: [usasales@powerint.com](mailto:usasales@powerint.com)*

**GERMANY**

Lindwurmstrasse 114  
80337, Munich  
Germany  
Phone: +49-895-527-39110  
Fax: +49-895-527-39200  
*e-mail: [eurosales@powerint.com](mailto:eurosales@powerint.com)*

**JAPAN**

Kosei Dai-3 Building  
2-12-11, Shin-Yokohama,  
Kohoku-ku, Yokohama-shi,  
Kanagawa 222-0033  
Japan  
Phone: +81-45-471-1021  
Fax: +81-45-471-3717  
*e-mail: [japansales@powerint.com](mailto:japansales@powerint.com)*

**TAIWAN**

5F, No. 318, Nei Hu Rd.,  
Sec. 1  
Nei Hu District  
Taipei 11493, Taiwan R.O.C.  
Phone: +886-2-2659-4570  
Fax: +886-2-2659-4550  
*e-mail: [taiwansales@powerint.com](mailto:taiwansales@powerint.com)*

**CHINA (SHANGHAI)**

Rm 2410, Charity Plaza, No. 88,  
North Caoxi Road,  
Shanghai, PRC 200030  
Phone: +86-21-6354-6323  
Fax: +86-21-6354-6325  
*e-mail: [chinasales@powerint.com](mailto:chinasales@powerint.com)*

**INDIA**

#1, 14<sup>th</sup> Main Road  
Vasanthanagar  
Bangalore-560052  
India  
Phone: +91-80-4113-8020  
Fax: +91-80-4113-8023  
*e-mail: [indiasales@powerint.com](mailto:indiasales@powerint.com)*

**KOREA**

RM 602, 6FL  
Korea City Air Terminal B/D,  
159-6  
Samsung-Dong, Kangnam-Gu,  
Seoul, 135-728 Korea  
Phone: +82-2-2016-6610  
Fax: +82-2-2016-6630  
*e-mail: [koreasales@powerint.com](mailto:koreasales@powerint.com)*

**EUROPE HQ**

1st Floor, St. James's House  
East Street, Farnham  
Surrey GU9 7TJ  
United Kingdom  
Phone: +44 (0) 1252-730-141  
Fax: +44 (0) 1252-727-689  
*e-mail: [eurosales@powerint.com](mailto:eurosales@powerint.com)*

**CHINA (SHENZHEN)**

3rd Floor, Block A,  
Zhongtuo International Business  
Center, No. 1061, Xiang Mei Rd,  
FuTian District, ShenZhen,  
China, 518040  
Phone: +86-755-8379-3243  
Fax: +86-755-8379-5828  
*e-mail: [chinasales@powerint.com](mailto:chinasales@powerint.com)*

**ITALY**

Via Milanese 20, 3<sup>rd</sup> Fl.  
20099 Sesto San Giovanni  
(MI) Italy  
Phone: +39-024-550-8701  
Fax: +39-028-928-6009  
*e-mail: [eurosales@powerint.com](mailto:eurosales@powerint.com)*

**SINGAPORE**

51 Newton Road,  
#19-01/05 Goldhill Plaza  
Singapore, 308900  
Phone: +65-6358-2160  
Fax: +65-6358-2015  
*e-mail: [singaporesales@powerint.com](mailto:singaporesales@powerint.com)*

**APPLICATIONS HOTLINE**

World Wide +1-408-414-9660

**APPLICATIONS FAX**

World Wide +1-408-414-9760