



GaAs pHEMT 50 / 75 Ohm DIFFERENTIAL AMPLIFIER, 0.04 - 1 GHz

Typical Applications

The HMC770LP4BE is ideal for:

- Cellular / PCS / 3G
- Fixed Wireless & WLAN
- CATV, Cable Modem & DBS
- Microwave Radio & Test Equipment
- IF & RF Applications

Features

- High Output IP3: +40 dBm
- Single Positive Supply: +5V
- Low Noise Figure: 2.5 dB ^[1]
- Differential RF I/O's
- 20 Lead 4x4 mm SMT Package: 16mm²

Functional Diagram

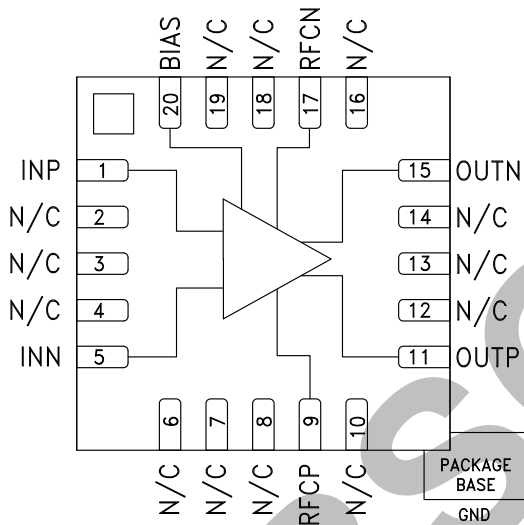

General Description

The HMC770LP4BE is a GaAs pHEMT Differential Gain Block MMIC amplifier covering 40 MHz to 1 GHz and packaged in a 4x4 mm plastic QFN SMT package. This versatile amplifier can be used as a cascadable IF or RF gain stage in both 50 Ohm and 75 Ohm applications. The HMC770LP4BE delivers 16 dB gain, and +40 dBm output, with only 2.5 dB noise figure. Differential I/Os make this amplifier ideal for transimpedance and SAW filter applications, and in transceivers where the IF path must be handled differentially for improved noise performance. Evaluation PCBs are all available with either SMA (50Ω) or Type F (75Ω) connectors.

Electrical Specifications, $T_A = +25^\circ\text{C}$, $V_{dd} = V_{dd1} = V_{dd2} = +5\text{V}$, $R_{bias} = R1 = 200\ \Omega$ ^[2]

Parameter	Min.	Typ.	Max.	Min.	Typ.	Max.	Units
	$Z_o = 50\ \text{Ohms}$			$Z_o = 75\ \text{Ohms}$			
Frequency Range	0.04 - 1			0.04 - 1			GHz
Gain ^[2]	12	16.5		12	16		dB
Gain Variation Over Temperature		0.006			0.008		dB / °C
Input Return Loss		17			15		dB
Output Return Loss		18			15		dB
Output Power for 1 dB Compression (P1dB)	20	23		21	23.5		dBm
Output Third Order Intercept (IP3) (Pout = 0 dBm per tone, 1 MHz spacing)		40			37.5		dBm
Noise Figure ^[2]		2.5	4		2.75	4	dB
Transimpedance		-			700		Ohms
Input Referred Current Noise ^[3]		-			6		pA / $\sqrt{\text{Hz}}$
Supply Current 1 (Idd1)		136	160		136	160	mA
Supply Current 2 (Idd2)		134	160		134	160	mA

[1] 1:1 Balun losses have NOT been removed from measurements. See list of materials for eval PCB for the type of balun.

[2] See application circuit

[3] Includes balun loss, no photo diode. See list of materials for eval PCB for the type of balun.



**GaAs pHEMT 50 / 75 Ohm
DIFFERENTIAL AMPLIFIER, 0.04 - 1 GHz**

50 Ohm Data

Gain & Return Loss [1]

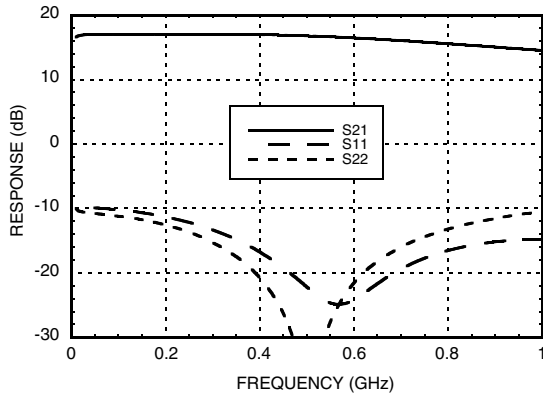

Gain vs. Temperature [1]

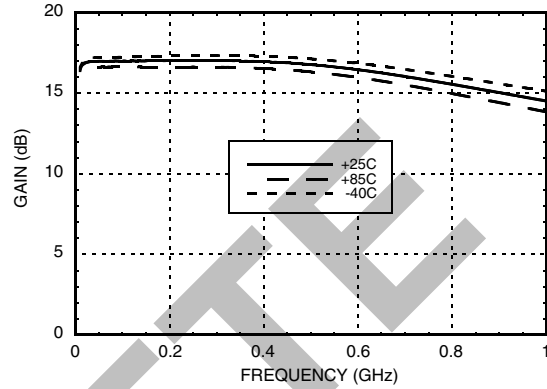

Gain vs. Vdd [1]

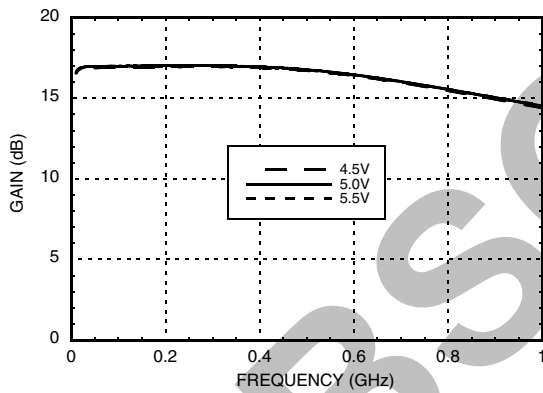

Gain vs. Rbias

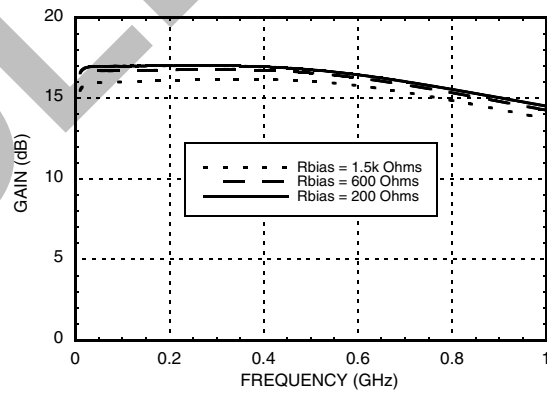

Return Loss vs. Temperature [1]

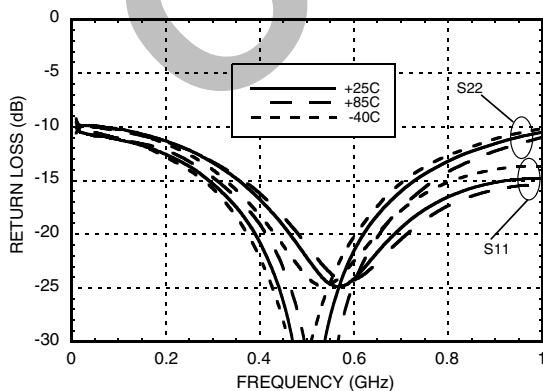

Return Loss vs. Vdd [1]

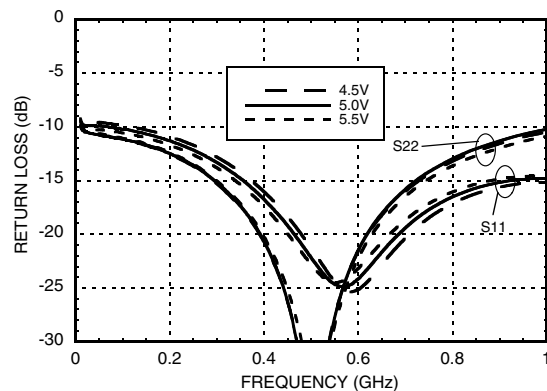

[1] Rbias=R1=200 Ohms. See application circuit



GaAs pHEMT 50 / 75 Ohm DIFFERENTIAL AMPLIFIER, 0.04 - 1 GHz

50 Ohm Data

Return Loss vs. Rbias

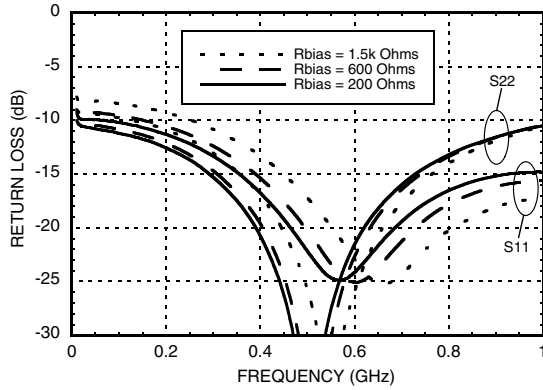

Isolation vs. Rbias

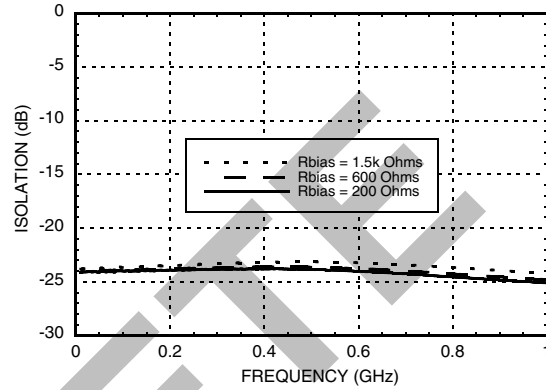

Noise Figure vs. Temperature [1]

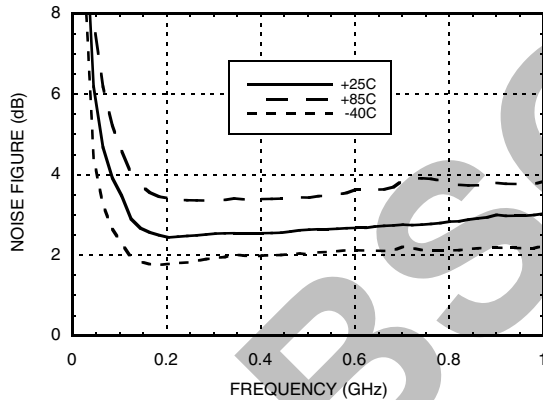

Noise Figure vs. Temperature for Low Frequencies [1][2]

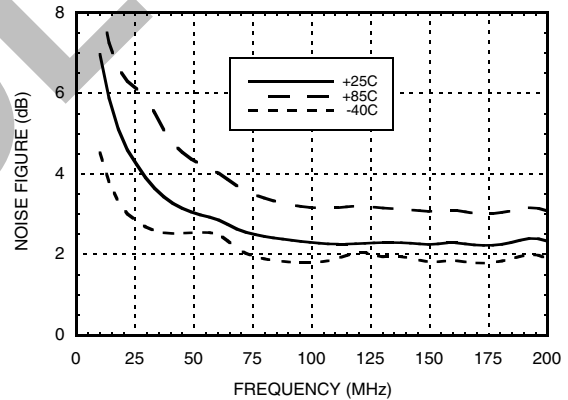

Noise Figure vs. Vdd [1]

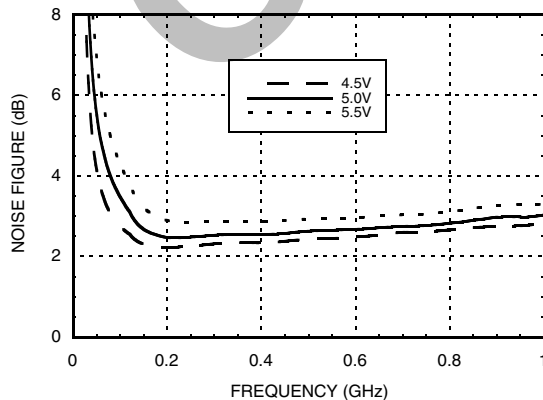

Noise Figure vs. Vdd for Low Frequencies [1][2]

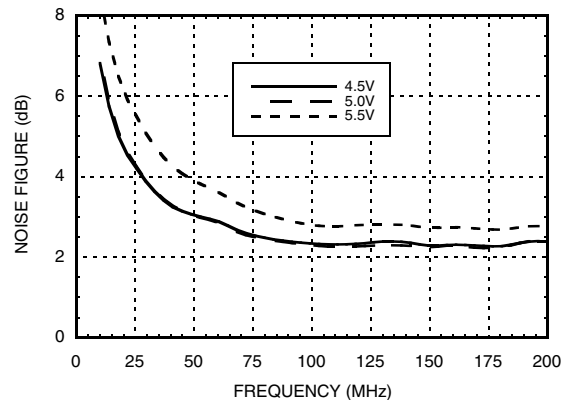

[1] Rbias=R1=200 Ohms. See application circuit.

[2] See application circuit for the tune for low frequencies.



**GaAs pHEMT 50 / 75 Ohm
DIFFERENTIAL AMPLIFIER, 0.04 - 1 GHz**

50 Ohm Data

Noise Figure vs. Rbias

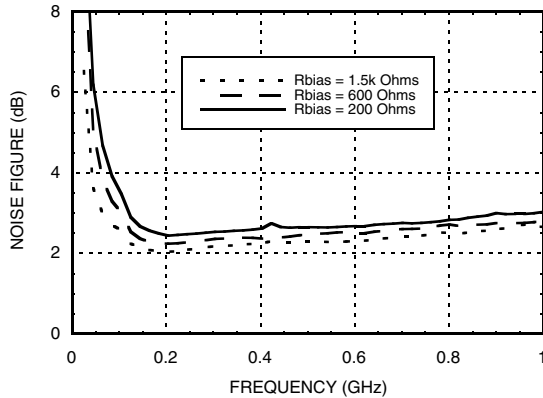

Noise Figure vs. Rbias for Low Frequencies [2]

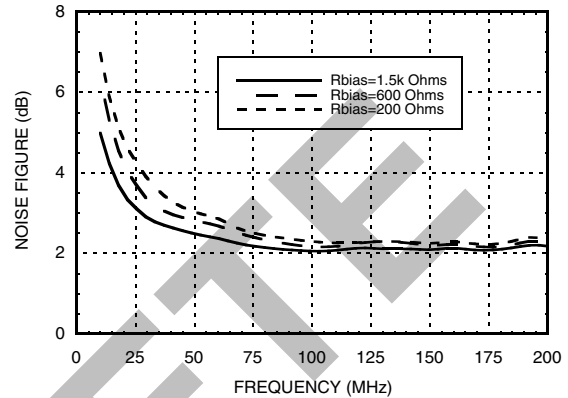

P1dB vs. Temperature [1]

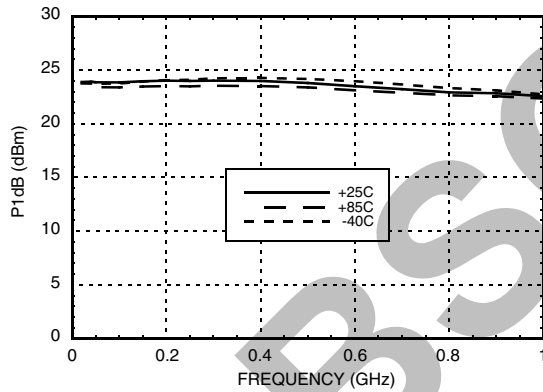

P1dB vs. Vdd [1]

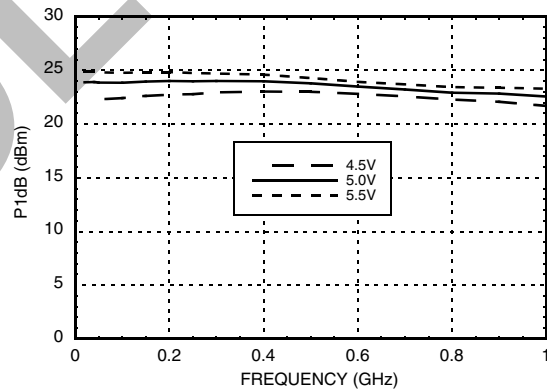

P1dB vs. Rbias [1]

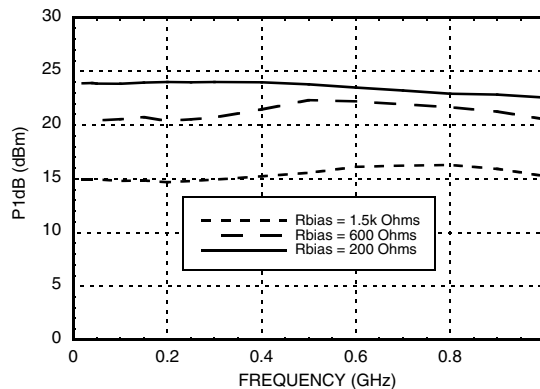

[1] Rbias=R1=200 Ohms. See application circuit.

[2] See application circuit for the tune for low frequencies.



**GaAs pHEMT 50 / 75 Ohm
DIFFERENTIAL AMPLIFIER, 0.04 - 1 GHz**

50 Ohm Data

Output IP3 vs. Temperature [1]

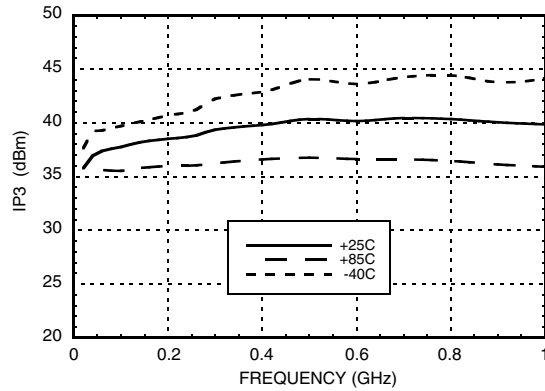

Output IP3 vs. Vdd [1]

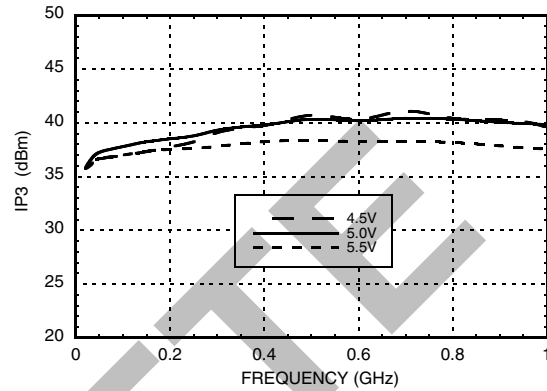

Output IP3 vs. Rbias

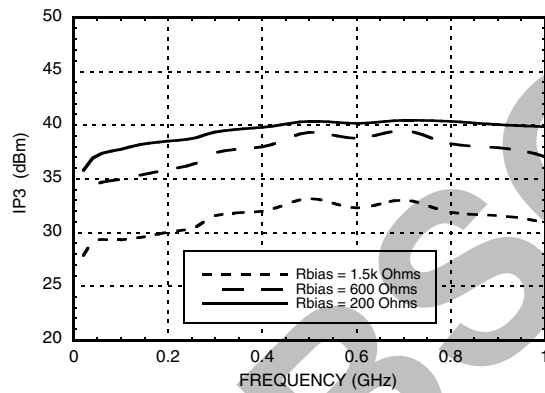

Idd vs. Rbias

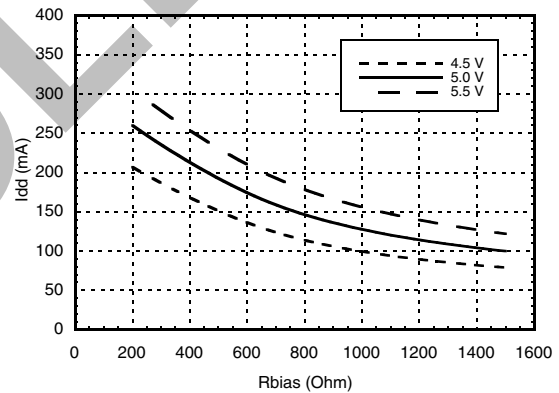

[1] Rbias=R1=200 Ohms. See application circuit



GaAs pHEMT 50 / 75 Ohm DIFFERENTIAL AMPLIFIER, 0.04 - 1 GHz

75 Ohm Data

Gain & Return Loss [1]

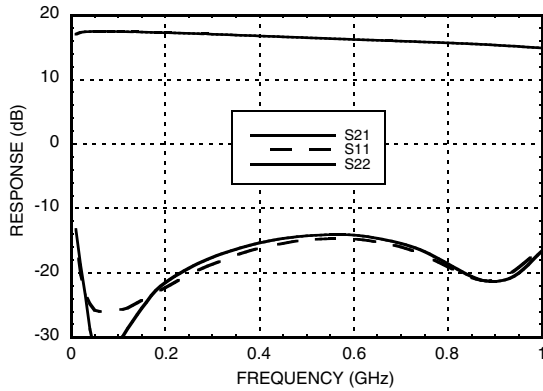

Gain vs. Temperature [1]

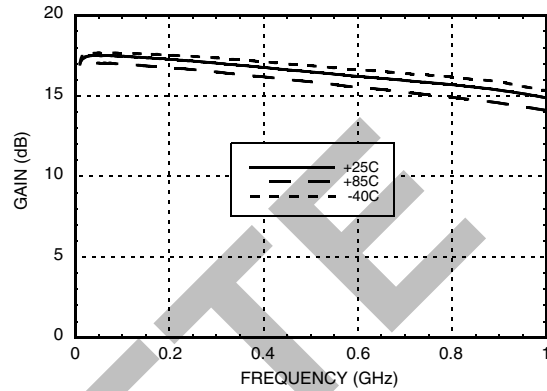

Gain vs. Vdd [1]

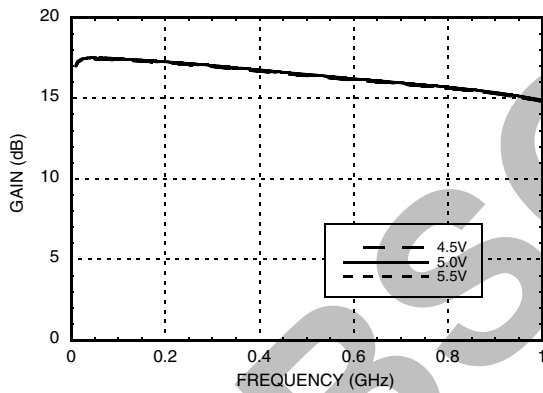

Gain vs. Rbias

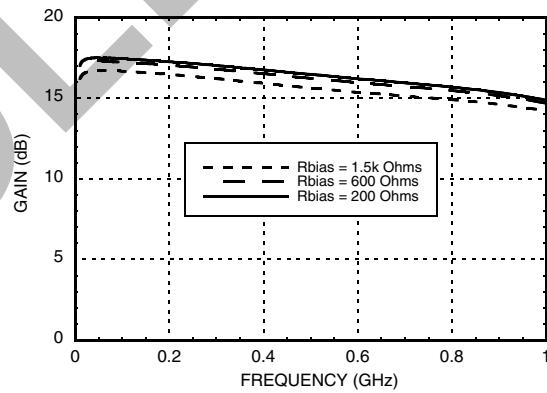

Return Loss vs. Temperature [1]

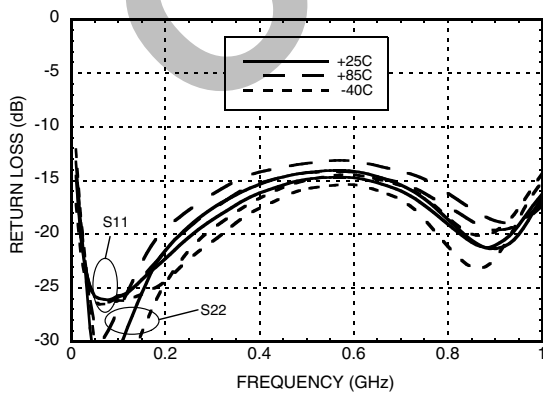

Return Loss vs. Vdd [1]

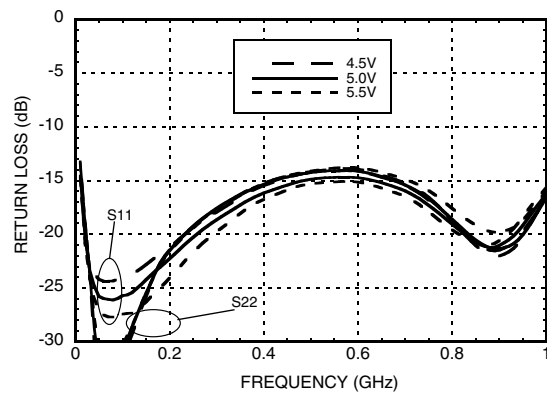

[1] Rbias=R1=200 Ohms. See application circuit



**GaAs pHEMT 50 / 75 Ohm
DIFFERENTIAL AMPLIFIER, 0.04 - 1 GHz**

75 Ohm Data

Return Loss vs. Rbias

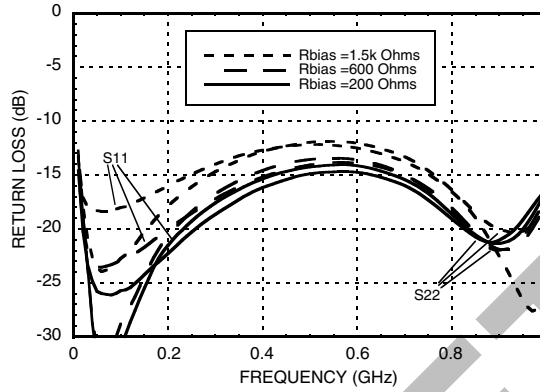

Noise Figure vs. Temperature [1]

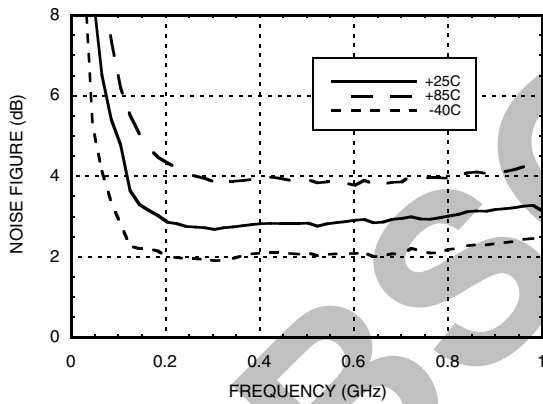

Noise Figure vs. Temperature for Low Frequencies [1][2]

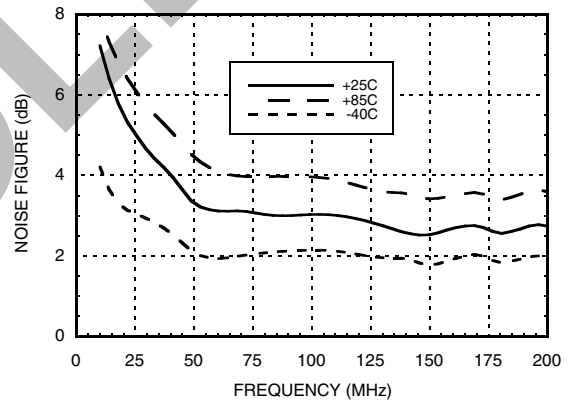

Noise Figure vs. Vdd [1]

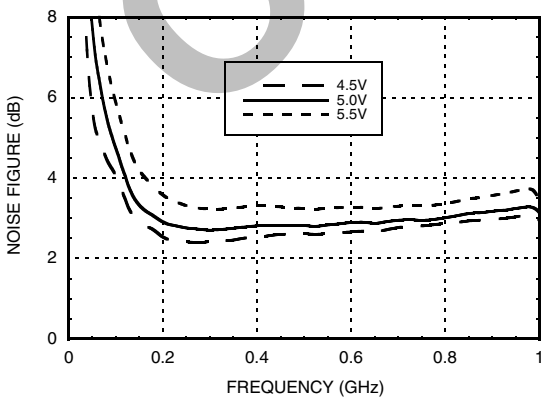

Noise Figure vs. Vdd for Low Frequencies [1][2]

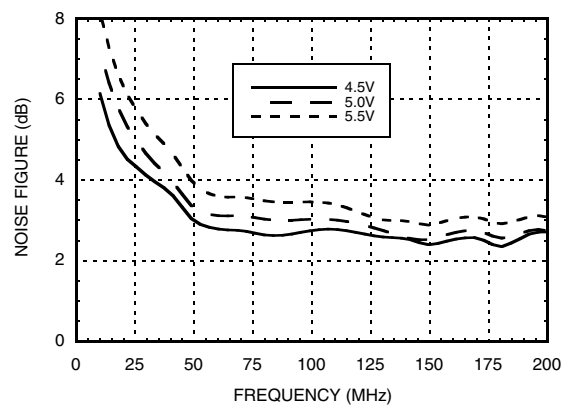

[1] Rbias=R1=200 Ohms. See application circuit.

[2] See application circuit for the tune for low frequencies.



GaAs pHEMT 50 / 75 Ohm DIFFERENTIAL AMPLIFIER, 0.04 - 1 GHz

75 Ohm Data

Noise Figure vs. Rbias

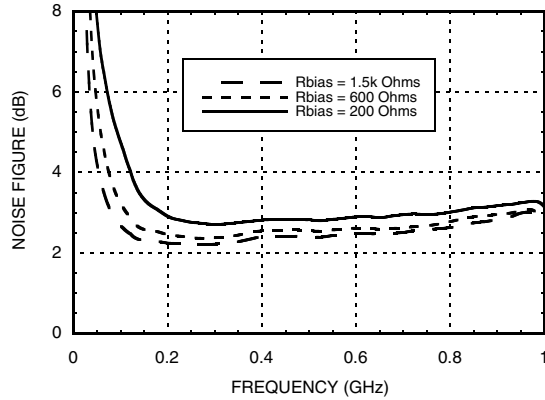

Noise Figure vs. Rbias for Low Frequencies ^{[1][2]}

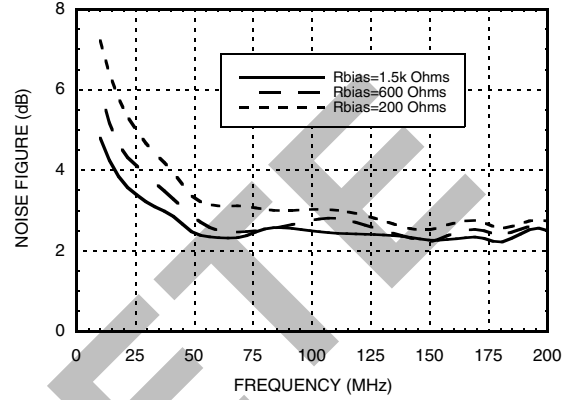

P1dB vs. Temperature ^[1]

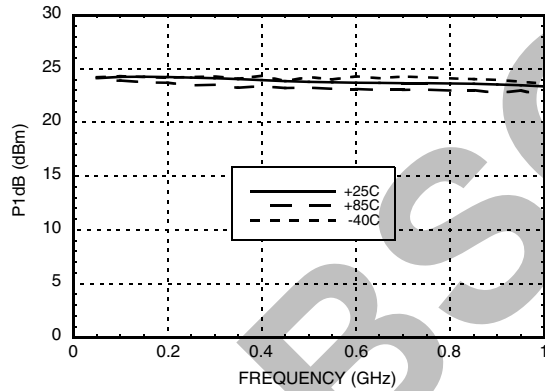

P1dB vs. Vdd ^[1]

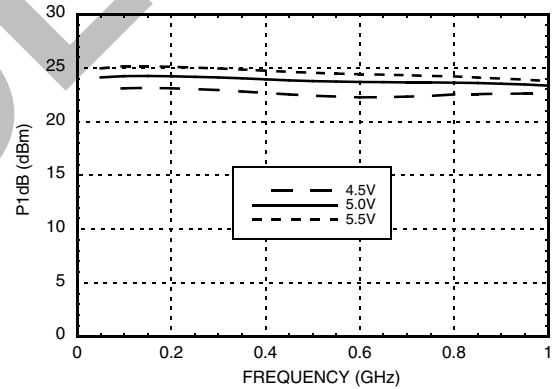

[1] Rbias=R1=200 Ohms. See application circuit.

[2] See application circuit for the tune for low frequencies.



**GaAs pHEMT 50 / 75 Ohm
DIFFERENTIAL AMPLIFIER, 0.04 - 1 GHz**

75 Ohm Data

P1dB vs. Rbias

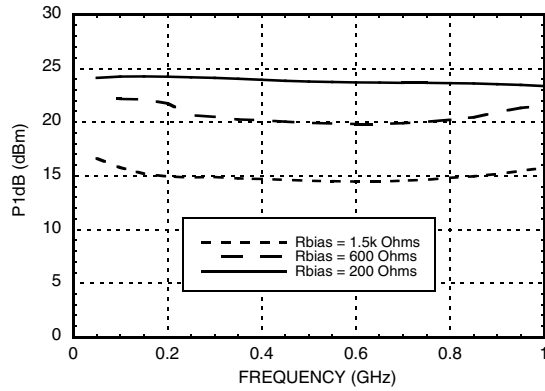

Output IP3 vs. Temperature [1]

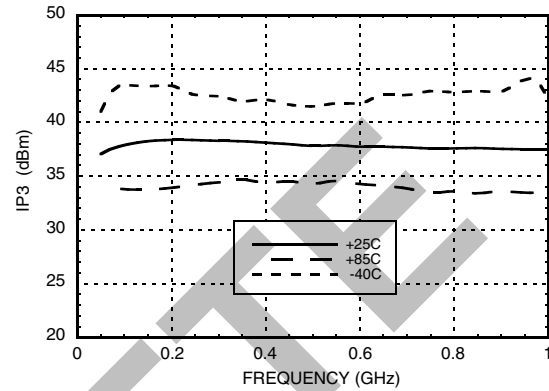

Output IP3 vs. Vdd [1]

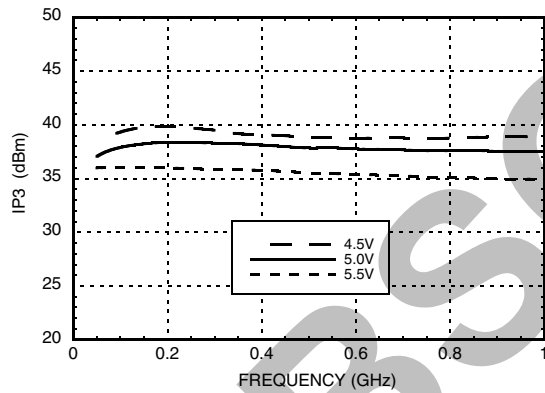

Output IP3 vs. Rbias

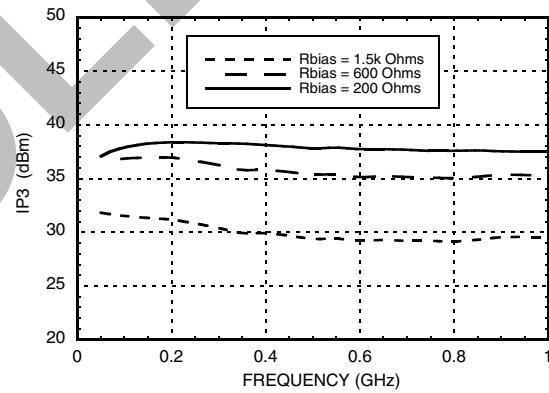

Input Referred Current Noise vs. Frequency [1]

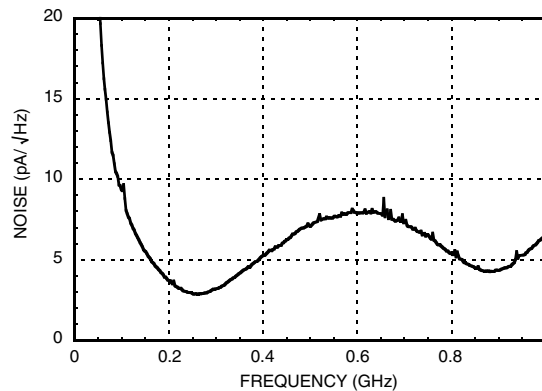

[1] Rbias=R1=200 Ohms. See application circuit



GaAs pHEMT 50 / 75 Ohm DIFFERENTIAL AMPLIFIER, 0.04 - 1 GHz

Absolute Maximum Ratings

Drain Bias Voltage	5.5 Vdc
RF Input Power (RFIN)	+20 dBm
Channel Temperature	150 °C
Continuous P _{diss} (T=85 °C) (derate 33.21 mW/ °C Above +85 °C)	2.16W
Thermal Resistance (channel to ground paddle)	30.11 °C/W
Storage Temperature	-65 to 150 °C
Operating Temperature	-40 to +85 °C
ESD Sensitivity (HBM)	Class 1A

Outline Drawing

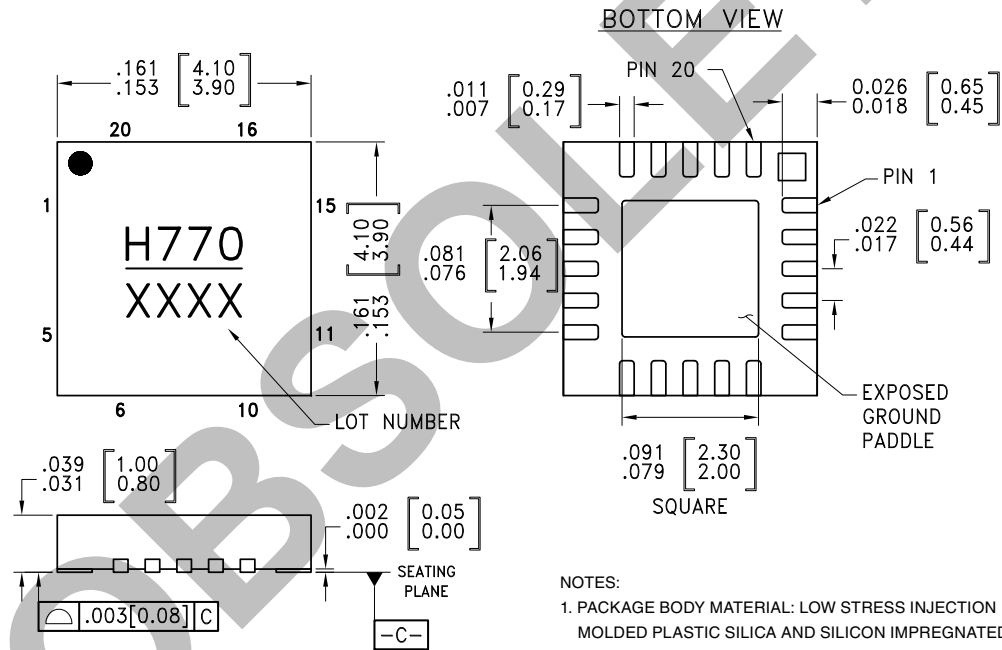

NOTES:

- PACKAGE BODY MATERIAL: LOW STRESS INJECTION MOLDED PLASTIC SILICA AND SILICON IMPREGNATED.
- LEAD AND GROUND PADDLE MATERIAL: COPPER ALLOY.
- LEAD AND GROUND PADDLE PLATING: 100% MATTE TIN
- DIMENSIONS ARE IN INCHES [MILLIMETERS].
- LEAD SPACING TOLERANCE IS NON-CUMULATIVE.
- PAD BURR LENGTH SHALL BE 0.15mm MAX. PAD BURR HEIGHT SHALL BE 0.05mm MAX.
- PACKAGE WARP SHALL NOT EXCEED 0.05mm
- ALL GROUND LEADS AND GROUND PADDLE MUST BE SOLDERED TO PCB RF GROUND.
- REFER TO HITTITE APPLICATION NOTE FOR SUGGESTED PCB LAND PATTERN.

Package Information

Part Number	Package Body Material	Lead Finish	MSL Rating	Package Marking ^[1]
HMC770LP4BE	RoHS-compliant Low Stress Injection Molded Plastic	100% matte Sn	MSL3 ^[2]	H770 XXXX

[1] 4-Digit lot number XXXX

[2] Max peak reflow temperature of 260 °C



GaAs pHEMT 50 / 75 Ohm DIFFERENTIAL AMPLIFIER, 0.04 - 1 GHz

Pin Descriptions

Pin Number	Function	Description	Interface Schematic
1, 5	INN, INP	This pin is DC coupled An off chip DC blocking capacitor is required	
11, 15	OUTP, OUTN	This pin is DC coupled An off chip DC blocking capacitor is required	
9, 17	RFCP, RFCN	RF Choke and DC Bias (Vdd) for the output stage	
2 - 4, 6 - 8, 10, 12 - 14, 16, 18, 19	N/C	These pins may be left unconnected.	
20	BIAS	This pin is used to set the DC current of the amplifier by selection of the external bias resistor. See application circuit.	
Package Base	GND	Package bottom must be connected to RF/DC ground.	

**Application Circuit -
for Transimpedance Amplifier Mode for use with 75 Ohm Evaluation Board**

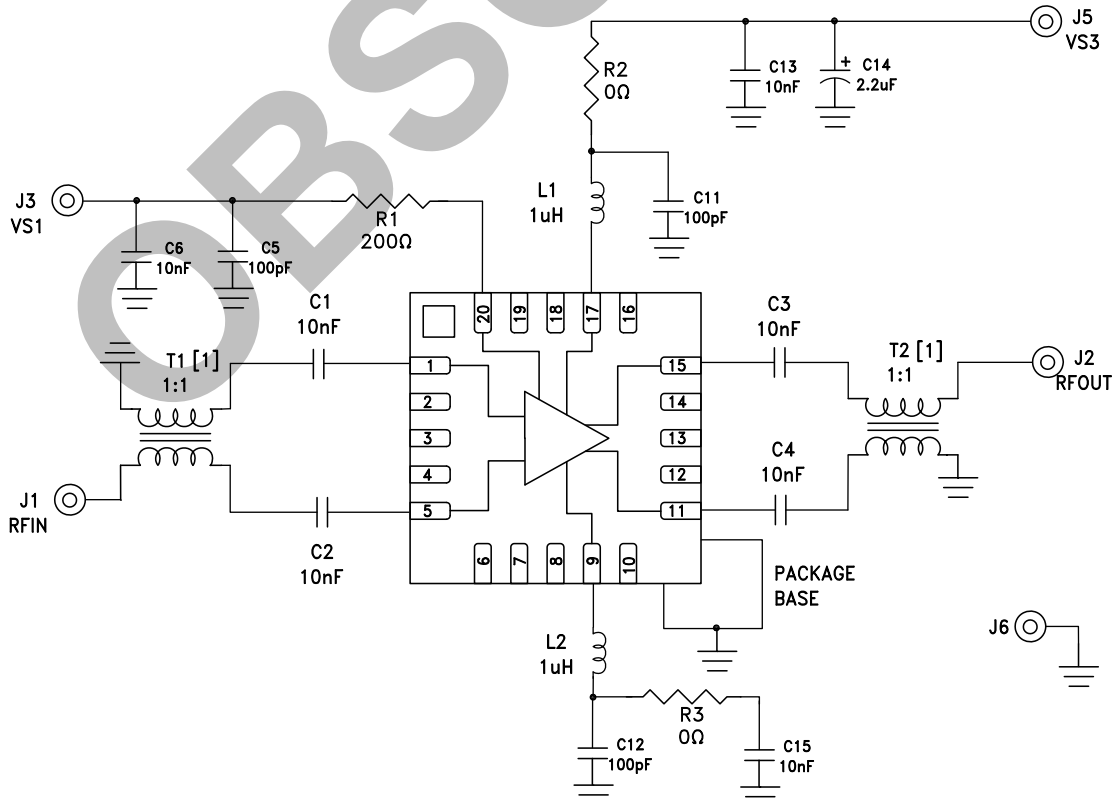

Information furnished by Analog Devices is believed to be accurate and reliable. However, no responsibility is assumed by Analog Devices for its use, nor for any infringements of patents or other rights of third parties that may result from its use. Specifications subject to change without notice. No license is granted by implication or otherwise under any patent or patent rights of Analog Devices. Trademarks and registered trademarks are the property of their respective owners.

For price, delivery, and to place orders: Analog Devices, Inc., One Technology Way, P.O. Box 9106, Norwood, MA 02062-9106 Phone: 781-329-4700 • Order online at www.analog.com Application Support: Phone: 1-800-ANALOG-D



GaAs pHEMT 50 / 75 Ohm DIFFERENTIAL AMPLIFIER, 0.04 - 1 GHz

**Application Circuit -
for Differential Amplifier Mode for use with either 50 or 75 Ohm Evaluation Board**

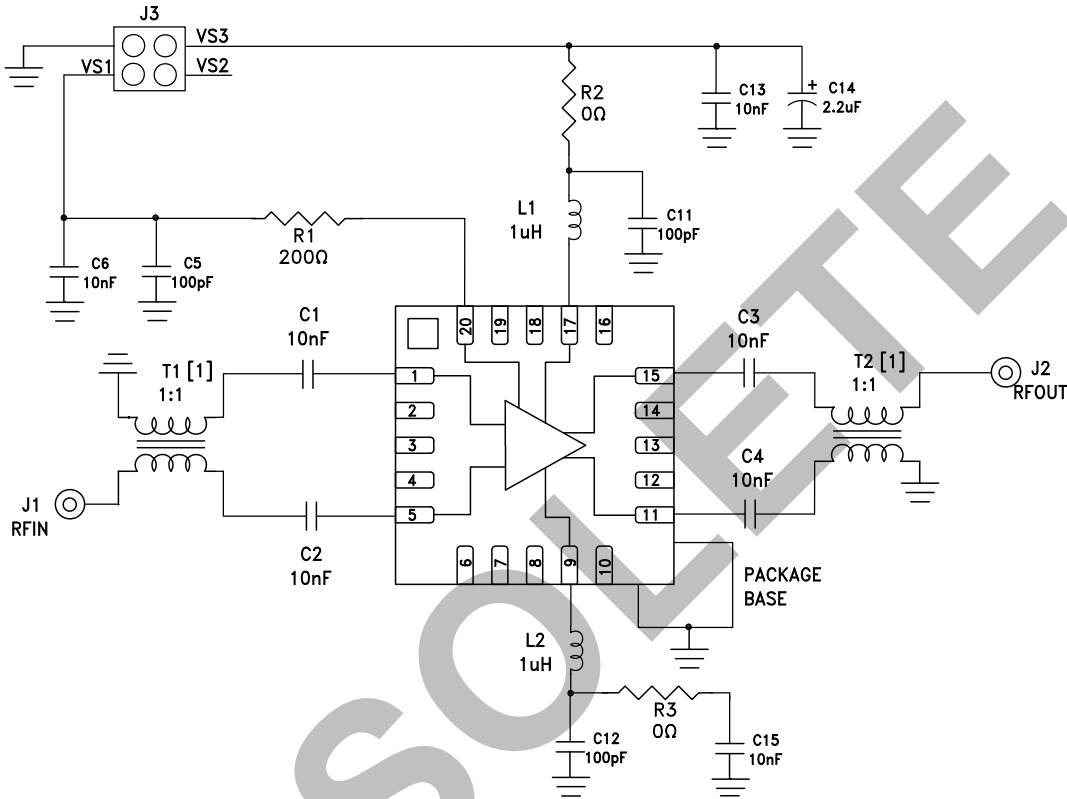

Components for Selected Options

Tune Option	50 Ohm	50 Ohm Low Frequency	75 Ohm	75 Ohm Low Frequency
Evaluation PCB Number	125980	127930	121737	127931
J1, J2	SMA connector		F connector	
T1, T2 [1]	ETC 1-1-13	ETC1-1T-5TR	ETC 1-1-13	ETC1-1T-5TR

[1] 1:1 Balun

Balun ETC1-1-13 is recommended for broadband and high frequency applications with the limitation that ETC1-1-13 degrades noise performance below 200 MHz.

Balun ETC1-1T-5TR is recommended for low frequency applications with the limitation that ETC1-1T-5TR degrades gain above 500 MHz.



**GaAs pHEMT 50 / 75 Ohm
DIFFERENTIAL AMPLIFIER, 0.04 - 1 GHz**

Evaluation PCB - 50 Ohm

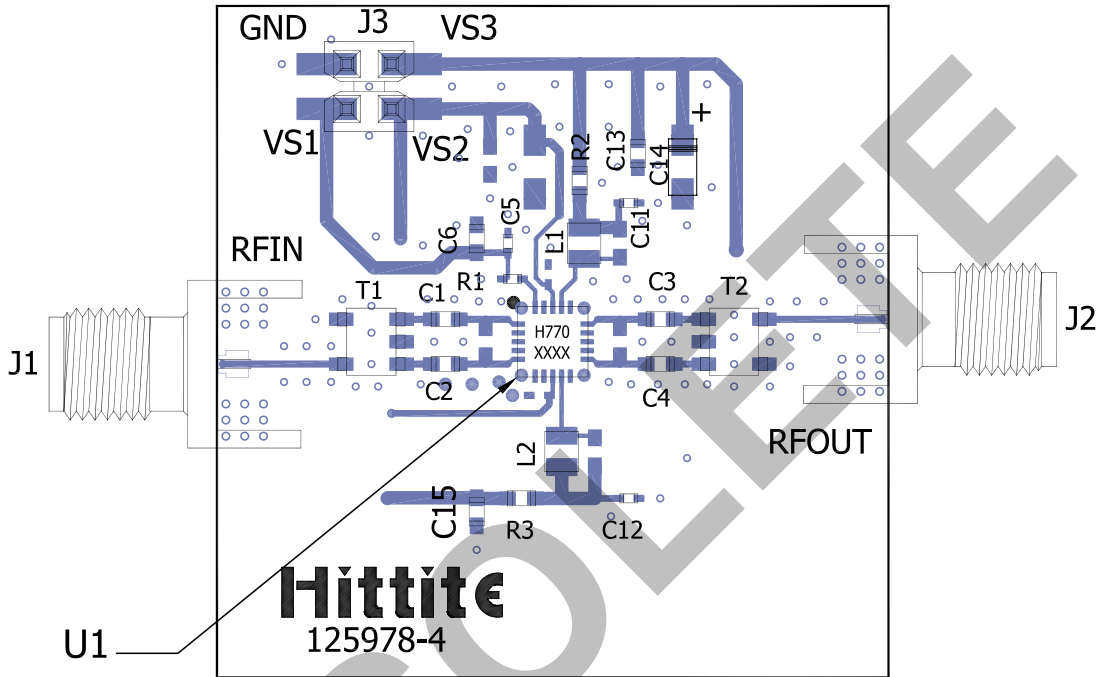

List of Materials for Evaluation PCB [1]

Item	Description
J1, J2	Johnson SMA Connector
J3	2 mm DC Header
C1-C4, C6, C13, C15	10 nF Capacitor, 0603 Pkg.
C5, C11, C12	100 pF Capacitor, 0402 Pkg.
C14	2.2 μ F Capacitor, Tantalum
L1, L2	1 μ H Inductor, 0805 Pkg.
R1 (Rbias)	200 Ohm Resistor, 0402 Pkg.
R2, R3	0 Ohm Resistor, 0805 Pkg.
T1, T2 [2]	1:1 Transformer
U1	HMC770LP4BE Gain Block Amplifier
PCB [3]	125978 Evaluation PCB

[1] When requesting an evaluation board, please reference the appropriate evaluation PCB number listed in the table "Components for Selected Options."

[2] Please refer to "Components for Selected Options" table for values

[3] Circuit Board Material: Rogers 4350

The circuit board used in the final application should use RF circuit design techniques. Signal lines should have 50 Ohm impedance while the package ground leads and exposed paddle should be connected directly to the ground plane similar to that shown. A sufficient number of via holes should be used to connect the top and bottom ground planes. The evaluation circuit board shown is available from Hittite upon request.

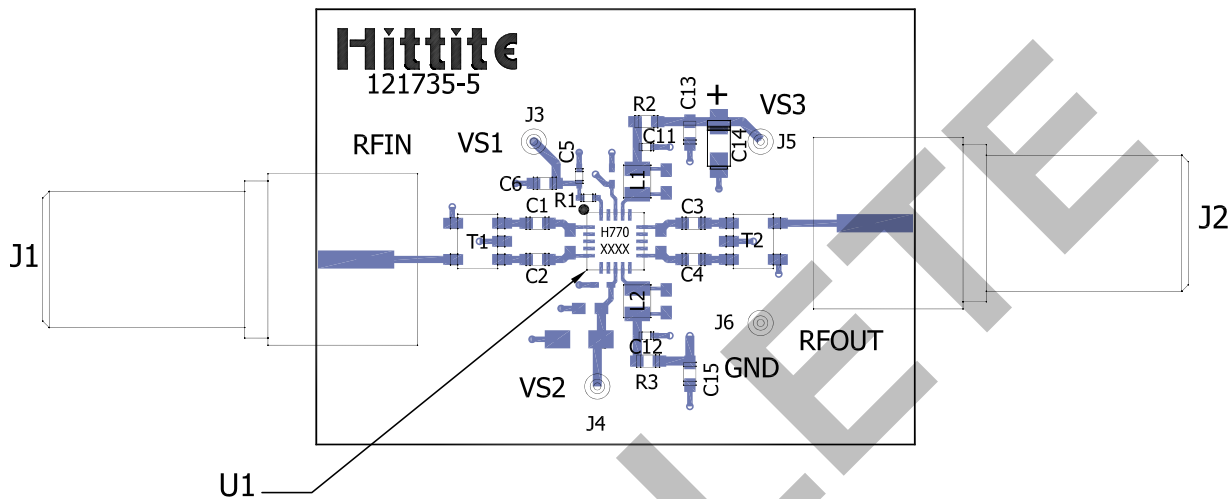
**GaAs pHEMT 50 / 75 Ohm
DIFFERENTIAL AMPLIFIER, 0.04 - 1 GHz**
Evaluation PCB - 75 Ohm

List of Materials for Evaluation PCB [1]

Item	Description
J1, J2	F-Connector
J3 - J6	DC Pin
C1 - C4, C6, C13, C15	10 nF Capacitor, 0603 Pkg.
C5, C11-C12	100 pF Capacitor, 0402 Pkg.
C14	2.2 μ F Capacitor, Tantalum
L1, L2	1 μ H Inductor, 0805 Pkg.
R1 (Rbias)	200 Ohm Resistor, 0402 Pkg.
R2, R3	0 Ohm Resistor, 0805 Pkg.
T1, T2 [2]	1:1 Transformer
U1	HMC770LP4BE Gain Block Amplifier
PCB [3]	121735 Evaluation PCB

[1] When requesting an evaluation board, please reference the appropriate evaluation PCB number listed in the table "Components for Selected Options."

[2] Please refer to "Components for Selected Options" table for values

[3] Circuit Board Material: Rogers 4350

The circuit board used in the final application should use RF circuit design techniques. Signal lines should have 75 ohm impedance while the package ground leads and exposed paddle should be connected directly to the ground plane similar to that shown. A sufficient number of via holes should be used to connect the top and bottom ground planes. The evaluation circuit board shown is available from Hittite upon request.