

RTKA223021DE0000BU

The [RAA223021](#) evaluation board (RTKA223021DE0000BU) is a high voltage buck converter that demonstrates a low-cost high performance non-isolated AC/DC conversion from an universal input of $85V_{AC}$ to $265V_{AC}$, to a 12V output with the output current up to 667mA.

The board has built-in overcurrent, short-circuit, input brownout, and over-temperature protection, and is designed on a single side PCB with a full-wave input rectification. It is pre-compliant with conducted EMI requirements by EN55022/CISPR 22.

RTKA223021DE0000BU uses the RAA223021 SOIC-7 packaged IC.

Features

- Universal input
- Single side PCB with low-cost external components
- EMI compliance for EN55022/CISPR22
- Standby power less than 20mW
- No audible noise

Specifications

This board is optimized for the following operating conditions:

- Input voltage: $85V_{AC} \sim 265V_{AC}$
- Output voltage: $12V_{DC}$
- Output current: 667mA max
- Output power: 8W
- Efficiency: >77% at 100% load; 80% at 50% load
- No-load power: 14mW at $120V_{AC}$; 16mW at $230V_{AC}$
- Load regulation: $\pm 2.4\%$, load range 10% to 100%
- Operating temperature: $-40 \sim 85^{\circ}C$
- Board dimension: 40mm x 60mm.

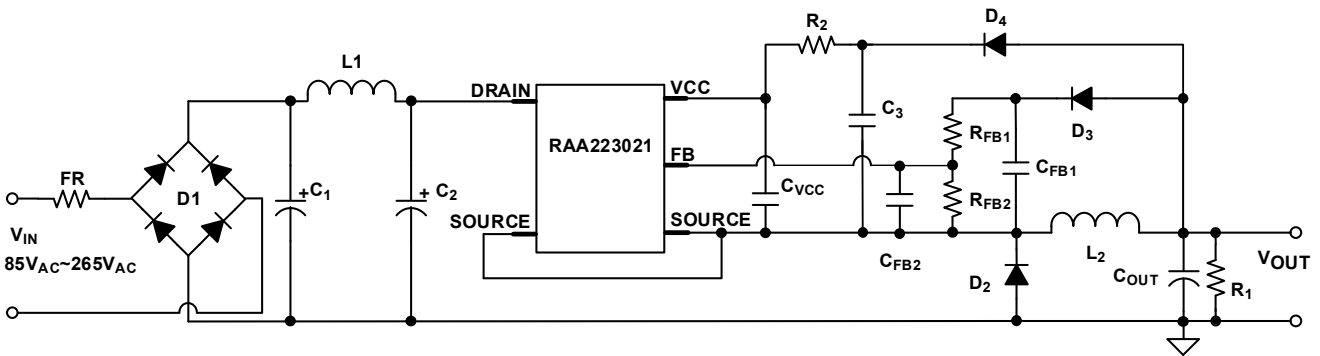

Figure 1. RTKA223021DE0000BU Block Diagram

Table 1. HV Buck of 021 Power Derating at 85°C Ambient Temperature

Output Setting Voltage (V)	120V _{AC}	230V _{AC}	90V _{AC} ~265V _{AC}
3.3	0.67A	0.58A	0.56A
5	0.67A	0.66A	0.6A
9	0.64A	0.6A	0.56A
12	0.56A	0.54A	0.5A
15	0.56A	0.52A	0.5A
24	0.49A	0.5A	0.46A

Table 2. Component Selection Guide

V_{OUT} (V)	C_{FB1} (nF)	R_{FB1} (k Ω)	R_{FB2} (k Ω)	L2 (H)	R2 (k Ω)	R1 (k Ω)
24	100	397	45	1m	30	100
15	100	397	76.5	1m	10	47
12	47	397	98.8	680 μ	10	47
9	100	397	142	470 μ	5.1	47
5	200	100	82	330 μ	100	10
3.3	200	100	180	330 μ	NC	3

Contents

1. Functional Description	4
1.1 Recommended Equipment and Operating Range	4
1.2 Setup and Configuration	4
2. Board Design	5
2.1 Layout Guidelines	6
2.2 Schematic Diagrams	7
2.3 Bill of Materials	8
2.4 Board Layout	9
3. Typical Performance Graphs	10
4. EMI Test Result	12
5. Ordering Information	12
6. Revision History	12

1. Functional Description

The RTKA223021DE0000BU is a buck regulator implemented with a high-side float-switching topology, with switching frequency up to 43kHz. D1 is a full bridge rectifier on the input end. FR is a 1A fuse providing input overcurrent protection. As an option, you can replace the standard fuse with a fusible resistor instead to limit inrush current.

C1, L1, and C2 consist of the input filter that provides the energy buffer after rectification and reduces conducted EMI noises to the input. L2, D2, and COUT are the buck converter components. RFB1, RFB2, CFB2, and CFB1 provide the output feedback signal to the IC. D4 and R2 provide V_{CC} biasing current after startup to increase the efficiency. They can be optional for low-cost low power applications. C_{VCC} is the IC supply capacitor.

1.1 Recommended Equipment and Operating Range

- AC Power supply capable of generating AC voltage from $85V_{AC}$ to $265V_{AC}$ at 60Hz/50Hz, with at least 100mA output current capability.
- Load resistor box with adjustable value of 18Ω and up, or an electronics load that can emulate a resistor load or current load up to 667mA.
- Multi-meters to measure the output voltage and current.
- Power meter to measure the AC input power.

1.2 Setup and Configuration

1. Program the AC power supply with a voltage between $85V_{AC}$ and $265V_{AC}$ at the corresponding frequency of 60Hz or 50Hz.
2. While the AC power supply is off, connect the output cables of the AC power supply to the L and N terminal of the RTKA223021DE0000BU. An optional power meter can be added in between the AC power supply output and the input of the board.
3. Connect the load to the output terminals VOUT and GND.
4. Connect a voltage meter to VOUT and GND and connect a current meter between board outputs and the load.
5. Turn on the AC power supply.

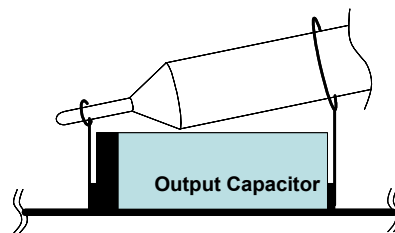

Figure 2. Proper Probe Setup to Measure Output Ripple

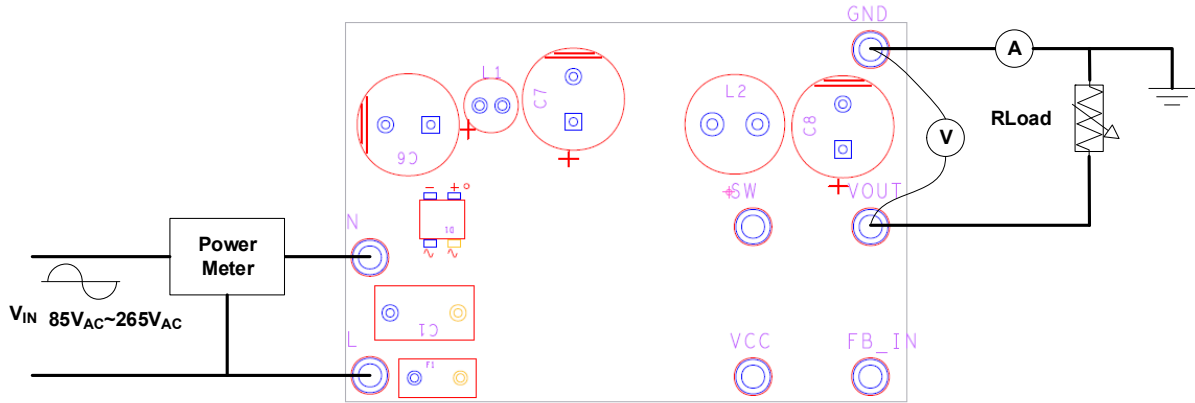

Figure 3. Proper Test Setup

2. Board Design



Figure 4. RTKA223021DE0000BU Evaluation Board (Top)

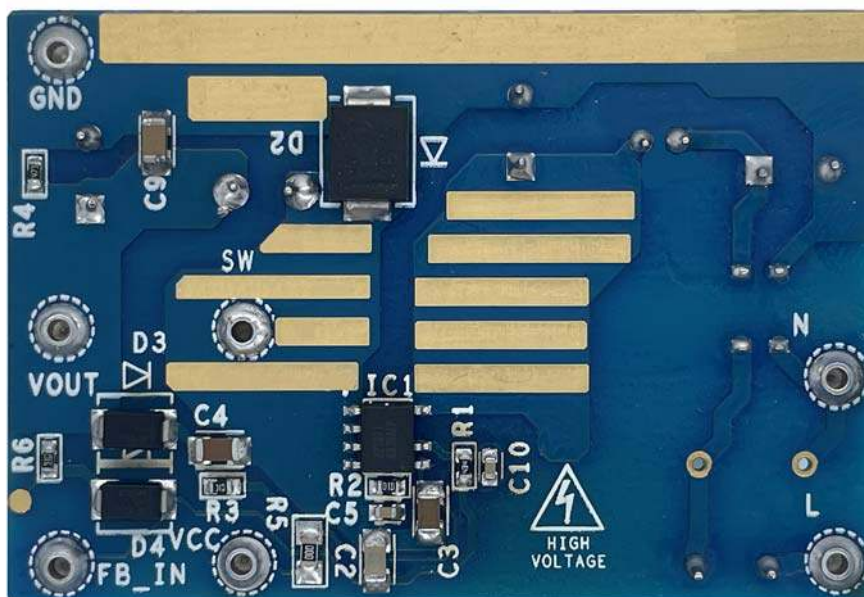

Figure 5. RTKA223021DE0000BU Evaluation Board (Bottom)

2.1 Layout Guidelines

Proper layout is important to ensure a stable operation, good thermal behavior, EMI performance and reliable operation for various operating environments. Please pay attention to the following layout recommendations.

- Leave proper spacing (minimum 1.4mm) between high voltage (max 400V) traces and low voltage traces.
- Keep a small loop from input filter capacitor to IC, switching inductor, output capacitor and to the ground of input capacitor.
- Keep a small loop consisted of switching inductor, output capacitor and freewheeling diode.
- Keep a small loop consisted of input filter capacitor to IC and freewheeling diode.
- Keep sufficient copper area on the IC drain and/or source pin (not less than 140mm² for 6-8W output power) for better thermal performance.
- Keep the switching inductor away from the input EMI inductor to avoid noise coupling, especially when an unshielded switching inductor is used.
- Keep a small loop from input filter capacitor to IC, sample hold circuit, output capacitor and to the ground of input capacitor.
- Place the V_{CC} decoupling cap and FB pin decoupling cap close to the pins.

2.2 Schematic Diagrams

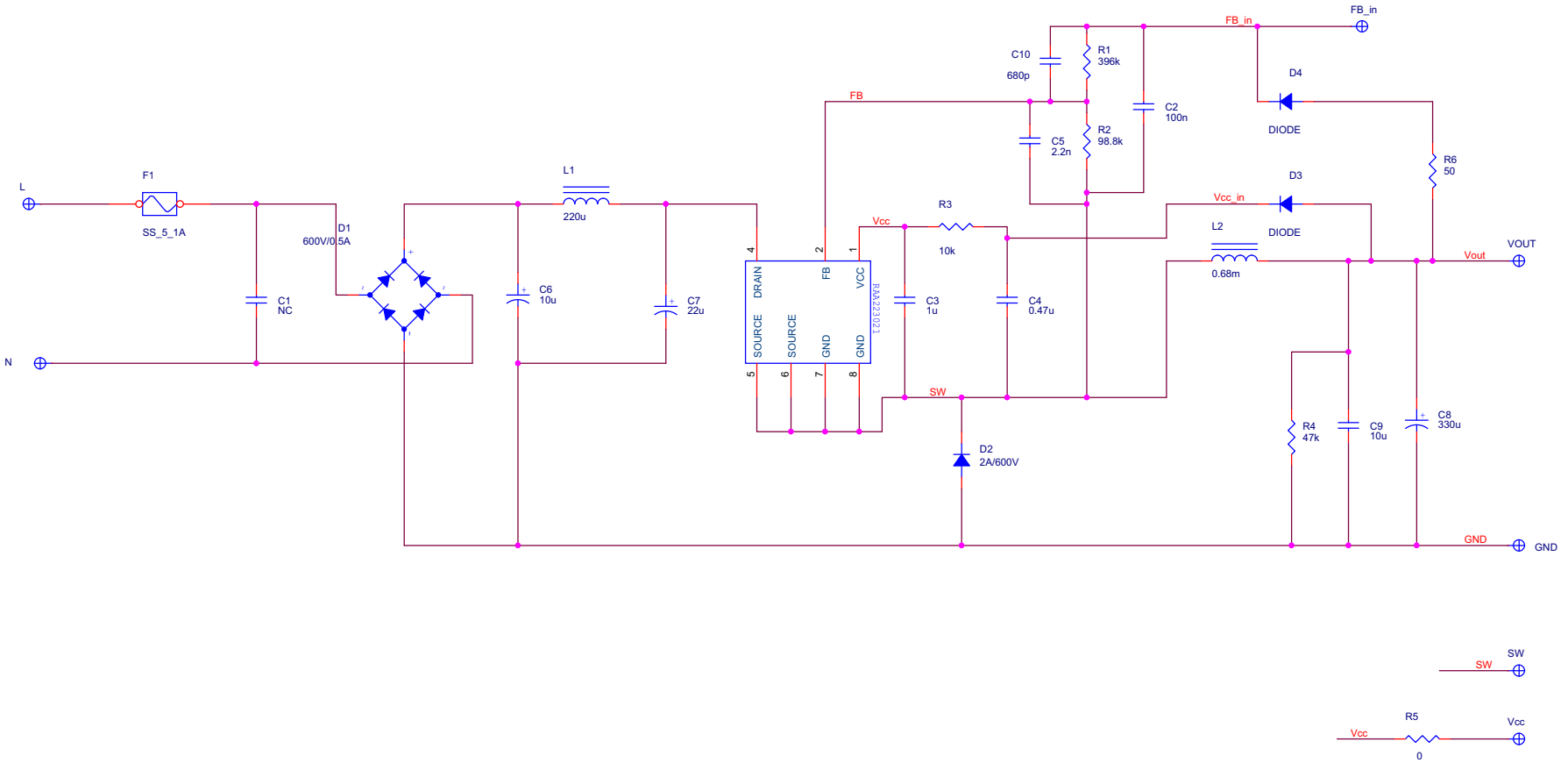

Figure 6. Schematic

2.3 Bill of Materials

Qty	Reference Designator	Description	Manufacturer	Manufacturer Part
1	C2	CAP CER 0.1 μ F 50V C0G 1206	TDK	CGA5L2C0G1H104J160AA
1	C3	CAP CER 1 μ F 25V X7R 1206	TDK	CGJ5L2X7R1E105K160AA
1	C4	CAP CER 0.47 μ F 50V X7R 1206	TDK	C3216X7R1H474K160AA
1	C5	CAP CER 2200pF 50V X7R 0603	TDK	CGA3E2X7R1H222K080AA
2	C6	CAP ALUM 10 μ F 20% 400V RADIAL	WE	860021375011
	C7	CAP ALUM 10 μ F 20% 400V RADIAL	WE	860021375011
1	C8	CAP ALUM POLY 330 μ F 20% 35V T/H	Panasonic	35SEK330M
1	C9	CAP CER 10 μ F 25V X7R 1206	TDK	C3216X7R1E106K160AB
1	C10	CAP CER 680pF 50V C0G 0603	TDK	CGA3E2C0G1H681J080AA
1	D1	BRIDGE RECT 1P 600V 500mA MBM	N/A	MB6M
1	D2	DIODE GEN PURP 600V 2A SMC	ST	STTH2R06S
2	D3	DIODE GEN PURP 600V 1A SMA	ST	STTH1R06A
	D4	DIODE GEN PURP 600V 1A SMA	ST	STTH1R06A
1	F1	FUSE BOARD MNT 1A 250V _{AC} RADIAL	Eaton - Electronics Division	SS-5-1A
1	IC1	700V, 8W AC/DC Buck Regulator	Renesas	RAA223021
1	L1	FIXED IND 220 μ H 500MA 1.2 Ω TH	WE	7447462221
1	L2	FIXED IND 680 μ H 900MA 790m Ω	WE	7447480681
1	R1	RES 397k Ω 1% 1/10W 0603	KOA	RN73H1JTDD3973F25
1	R2	RES 98.8k Ω 1% 1/10W 0603	KOA	RN73R1JTDD9882F25
1	R3	RES SMD 10k Ω 5% 1/10W 0603	Panasonic	ERJ-3GEYJ103V
1	R4	RES SMD 47k Ω 5% 1/10W 0603	Yageo	RC0603JR-0747KL
1	R5	RES 0 OHM JUMPER 1/4W 1206	Stackpole Electronics Inc	RMCF1206ZT0R00
1	R6	RES SMD 50 Ω 0.1% 1/10W 0603	Yageo	RT0603BRE0750RL
7	TP	CONN-DBL TURRET, TH, 0.109LENGTH, BRASS/TIN, ROHS	Keystone Electronics	1514-2

2.4 Board Layout

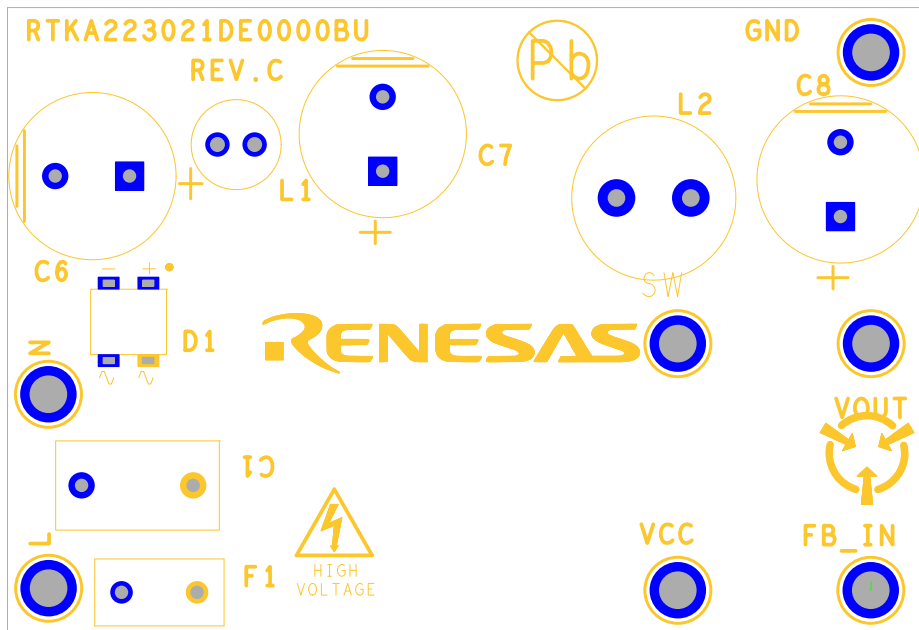

Figure 7. Top Layer

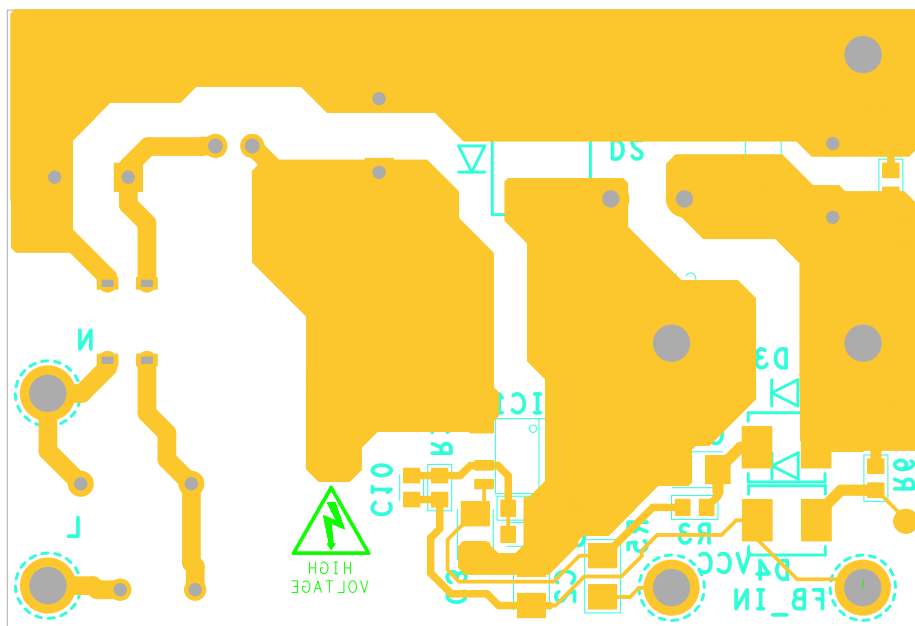

Figure 8. Bottom Layer

3. Typical Performance Graphs

$V_{OUT} = 12V$, unless otherwise noted.

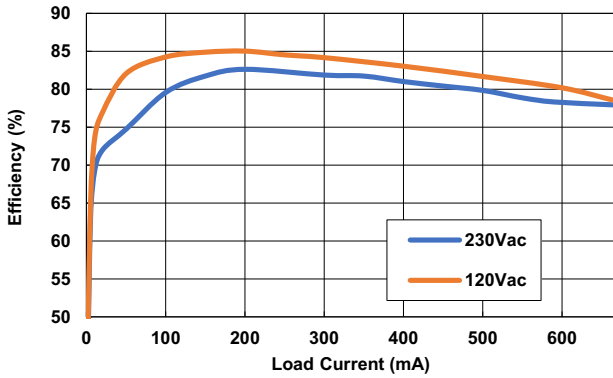

Figure 9. Efficiency

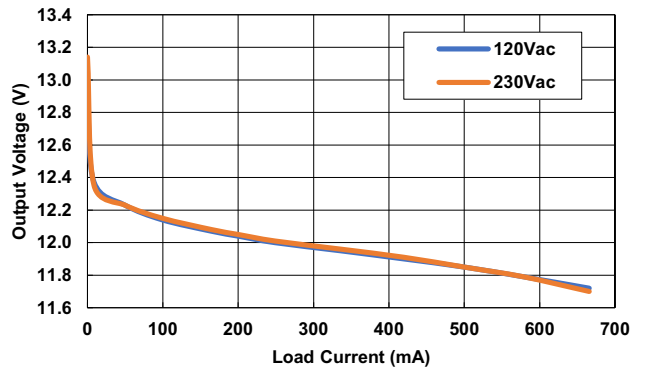

Figure 10. Load Regulation

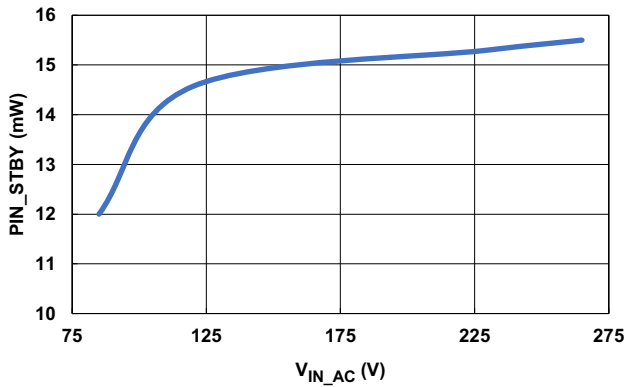

Figure 11. No Load Power Loss

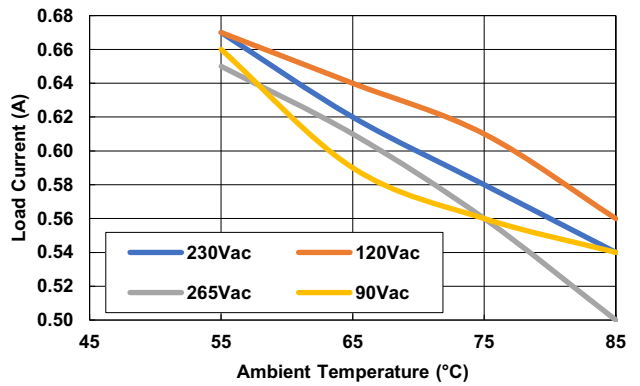

Figure 12. 12V Output Power Derating

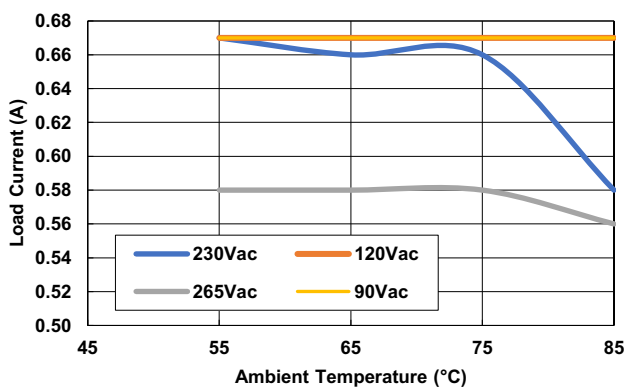

Figure 13. 3.3V Output Power Derating

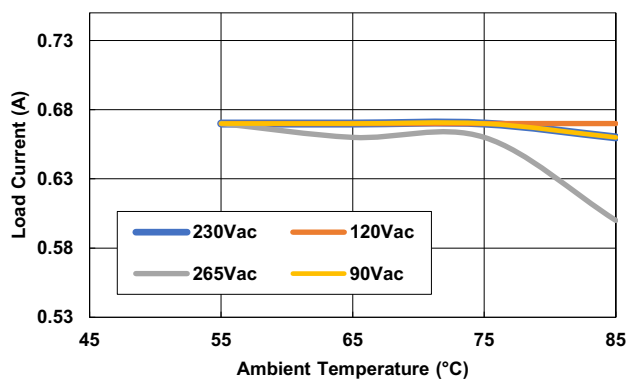

Figure 14. 5V Output Power Derating

$V_{OUT} = 12V$, unless otherwise noted. (Cont.)

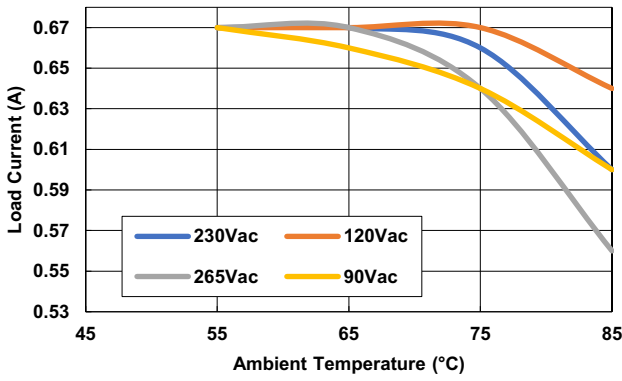

Figure 15. 9V Output Power Derating

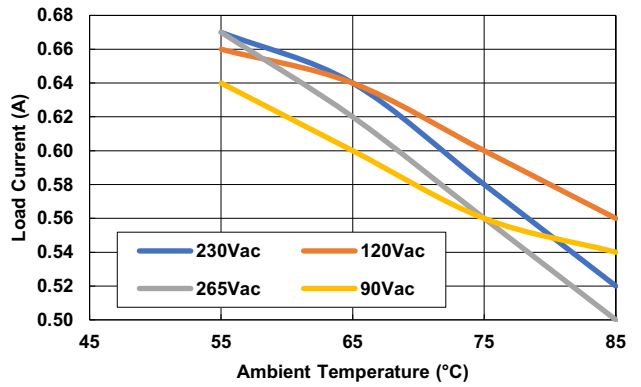

Figure 16. 15V Output Power Derating

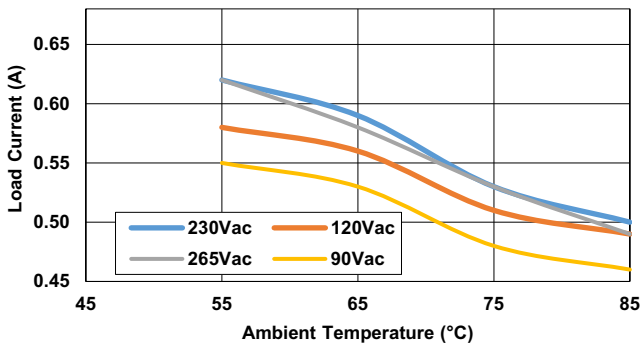

Figure 17. 24V Output Power Derating

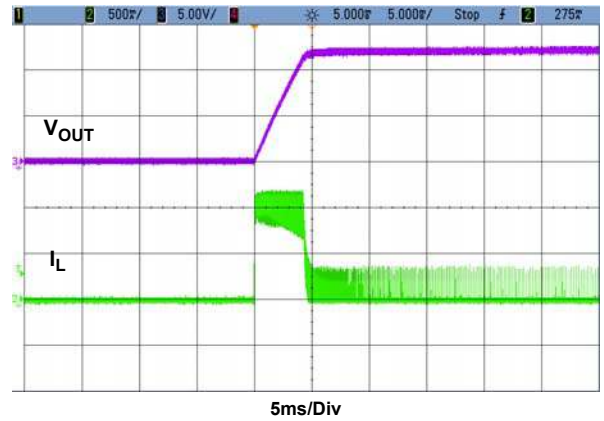

Figure 18. $V_{IN} = 230V_{AC}$, $I_{OUT} = 0A$

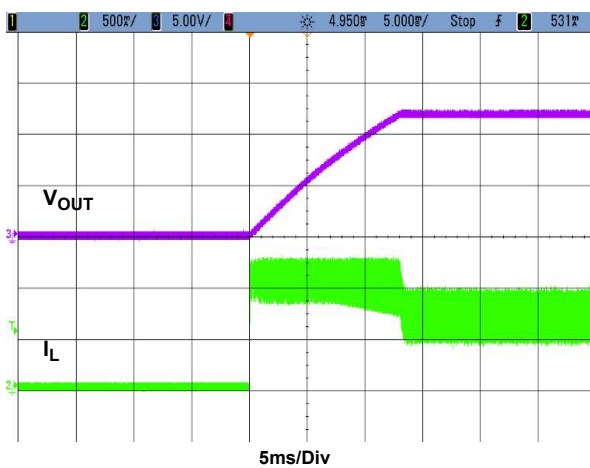

Figure 19. $V_{IN} = 230V_{AC}$, $I_{OUT} = 0.667A$

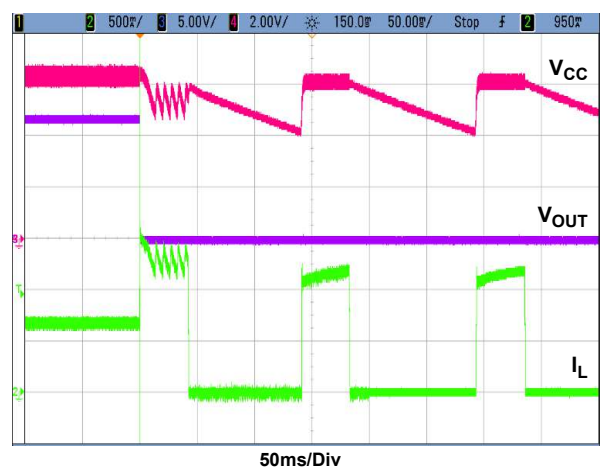
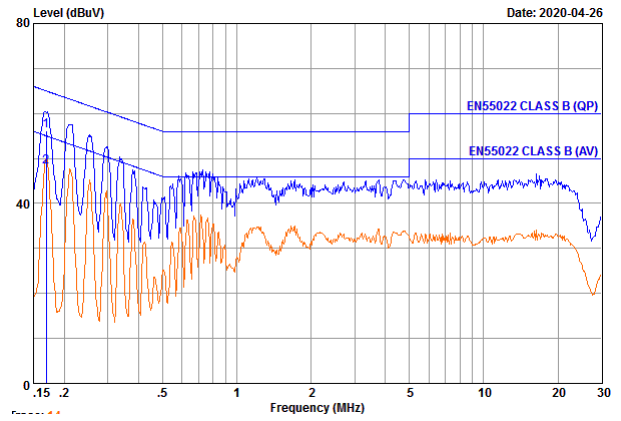
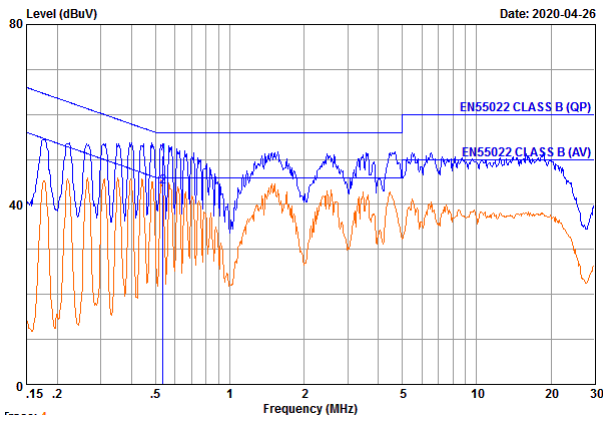

Figure 20. $V_{IN} = 230V_{AC}$, $I_{OUT} = 0.667A$ to short

4. EMI Test Result

Conducted EMI compliance for EN55022/CISPR22 (12V/600mA output)



5. Ordering Information

Part Number	Description
RTKA223021DE0000BU	High Voltage BUCK Converter Evaluation Board

6. Revision History

Revision	Date	Description
1.1	May 26, 2021	Updated Table 1 and 2 with 24V output. Added 24V Figure 17 and 18.
1.0	Mar 26, 2021	Initial release

IMPORTANT NOTICE AND DISCLAIMER

RENESAS ELECTRONICS CORPORATION AND ITS SUBSIDIARIES (“RENESAS”) PROVIDES TECHNICAL SPECIFICATIONS AND RELIABILITY DATA (INCLUDING DATASHEETS), DESIGN RESOURCES (INCLUDING REFERENCE DESIGNS), APPLICATION OR OTHER DESIGN ADVICE, WEB TOOLS, SAFETY INFORMATION, AND OTHER RESOURCES “AS IS” AND WITH ALL FAULTS, AND DISCLAIMS ALL WARRANTIES, EXPRESS OR IMPLIED, INCLUDING, WITHOUT LIMITATION, ANY IMPLIED WARRANTIES OF MERCHANTABILITY, FITNESS FOR A PARTICULAR PURPOSE, OR NON-INFRINGEMENT OF THIRD PARTY INTELLECTUAL PROPERTY RIGHTS.

These resources are intended for developers skilled in the art designing with Renesas products. You are solely responsible for (1) selecting the appropriate products for your application, (2) designing, validating, and testing your application, and (3) ensuring your application meets applicable standards, and any other safety, security, or other requirements. These resources are subject to change without notice. Renesas grants you permission to use these resources only for development of an application that uses Renesas products. Other reproduction or use of these resources is strictly prohibited. No license is granted to any other Renesas intellectual property or to any third party intellectual property. Renesas disclaims responsibility for, and you will fully indemnify Renesas and its representatives against, any claims, damages, costs, losses, or liabilities arising out of your use of these resources. Renesas' products are provided only subject to Renesas' Terms and Conditions of Sale or other applicable terms agreed to in writing. No use of any Renesas resources expands or otherwise alters any applicable warranties or warranty disclaimers for these products.

(Rev.1.0 Mar 2020)

Corporate Headquarters

TOYOSU FORESIA, 3-2-24 Toyosu,
Koto-ku, Tokyo 135-0061, Japan
www.renesas.com

Contact Information

For further information on a product, technology, the most up-to-date version of a document, or your nearest sales office, please visit:
www.renesas.com/contact/

Trademarks

Renesas and the Renesas logo are trademarks of Renesas Electronics Corporation. All trademarks and registered trademarks are the property of their respective owners.