

## Features

- Halogen Free. "Green" Device (Note 1)
- High Surge Forward Current Capability
- Low Power Loss, High Efficiency
- Lead Free Finish/RoHS Compliant(Note 2)("P" Suffix Designates Compliant. See Ordering Information)
- Epoxy Meets UL 94 V-0 Flammability Rating
- Moisture Sensitivity Level 1

## Maximum Ratings

- Operating Junction Temperature Range: -55°C to +150°C
- Storage Temperature Range: -55°C to +150°C
- Typical Thermal Resistance: 8.0 °C/W Junction to Case

MCC Part Number	Device Marking	Maximum Recurrent Peak Reverse Voltage	Maximum RMS Voltage	Maximum DC Blocking Voltage
MBR15U150	15U150	150V	105V	150V

## Electrical Characteristics @ 25°C Unless Otherwise Specified

Average Forward Current	$I_{F(AV)}$	15A	$T_C = 60^\circ\text{C}$
Peak Forward Surge Current	$I_{FSM}$	250A	8.3ms, Half Sine
Forward Voltage	$V_F$	0.80V(Typ) 0.84V(Max)	$I_F=15A$ $T_J=25^\circ\text{C}$
		0.68V(Typ) 0.73V(Max)	$I_F=15A$ $T_J=125^\circ\text{C}$
Reverse Current	$I_R$	10uA(Max) 2mA(Max)	$V_R=150$ ; $T_J=25^\circ\text{C}$ $V_R=150$ ; $T_J=125^\circ\text{C}$
Typical Junction Capacitance	$C_J$	310pF	Measured at 1.0MHz $V_R=4.0V$
Current Squared Time	$I^2T$	259 A <sup>2</sup> s	1ms ≤ t < 8.3ms $T_J=25^\circ\text{C}$

Note: 1. Halogen free "Green" products are defined as those which contain <900ppm bromine, <900ppm chlorine (<1500ppm total Br + Cl) and <1000ppm antimony compounds.

2. High Temperature Solder Exemption Applied, see EU Directive Annex 7a.

## Internal Structure

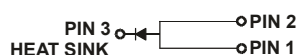

# 15 Amp Schottky Barrier Rectifier 150 Volts

## TO-277

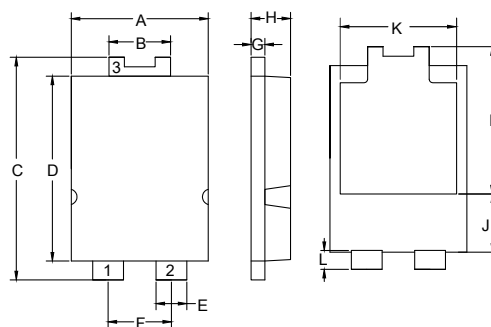

DIM	DIMENSIONS				NOTE
	INCHES		MM		
	MIN	MAX	MIN	MAX	
A	0.154	0.161	3.90	4.10	
B	0.067	0.075	1.70	1.90	
C	0.252	0.260	6.40	6.60	
D	0.209	0.217	5.30	5.50	
E	0.031	0.039	0.80	1.00	
F	0.071	0.075	1.80	1.90	
G	0.014	0.018	0.35	0.45	
H	0.043	0.047	1.10	1.20	
I	0.161	0.177	4.10	4.50	
J	0.059	0.075	1.50	1.90	
K	0.114	0.134	2.90	3.40	
L	0.022	0.030	0.55	0.75	

## Suggested Solder Pad Layout

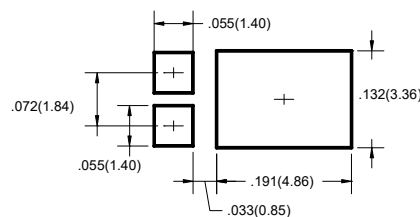

**Curve Characteristics**

Fig. 1 - Forward Current Derating Curve

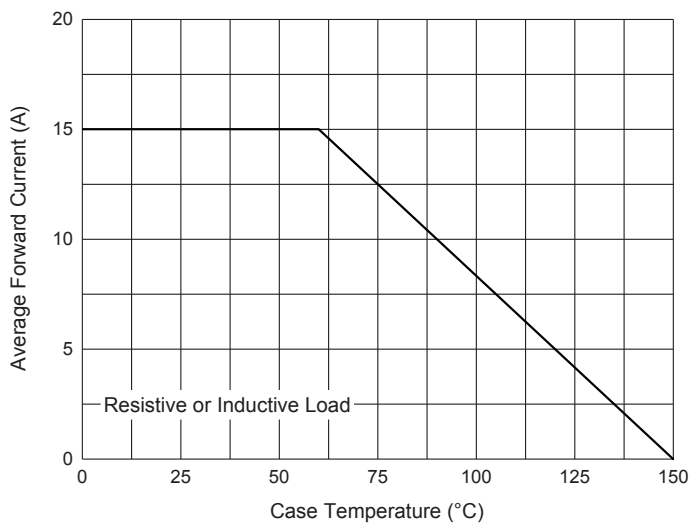

Fig. 2 - Maximum Non-Repetitive Peak Forward Surge Current

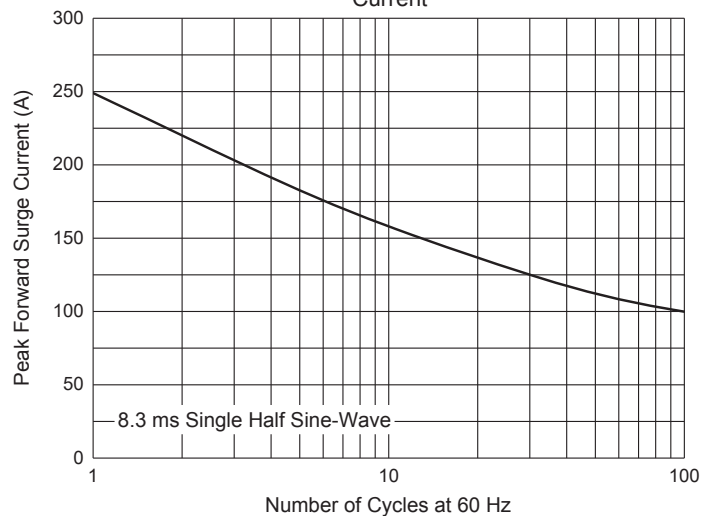

Fig. 3 - Typical Instantaneous Forward Characteristics

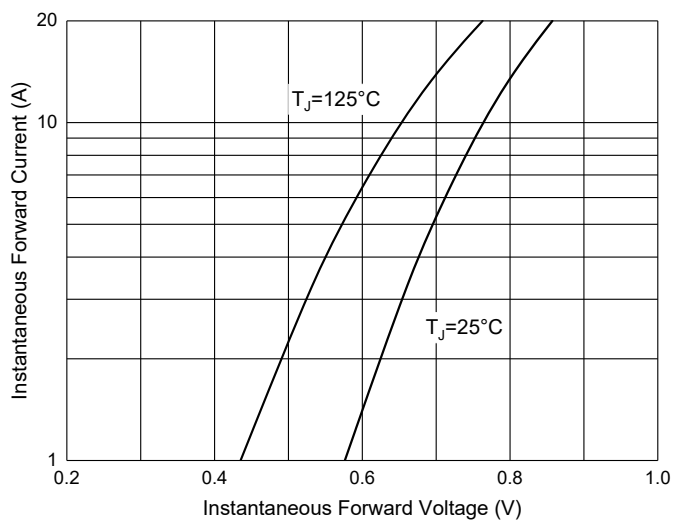
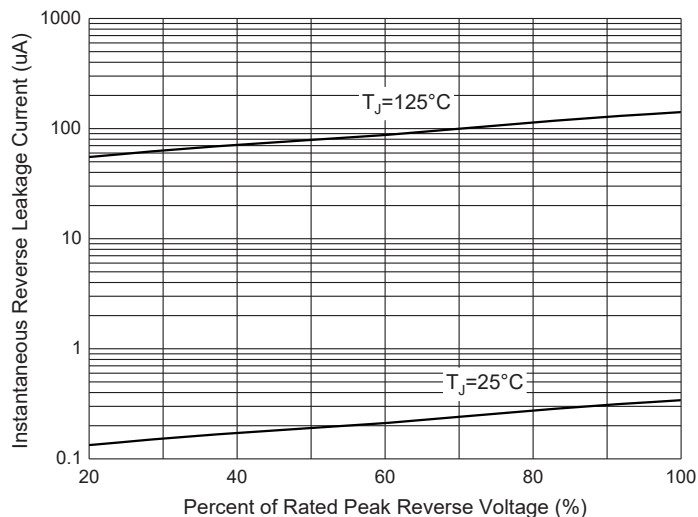

Fig. 4 - Typical Reverse Leakage Characteristics



## Ordering Information

Device	Packing
Part Number-TP	Tape&Reel: 4Kpcs/Reel

**\*\*\*IMPORTANT NOTICE\*\*\***

*Micro Commercial Components Corp.* reserves the right to make changes without further notice to any product herein to make corrections, modifications, enhancements, improvements, or other changes. *Micro Commercial Components Corp.* does not assume any liability arising out of the application or use of any product described herein; neither does it convey any license under its patent rights, nor the rights of others. The user of products in such applications shall assume all risks of such use and will agree to hold *Micro Commercial Components Corp.* and all the companies whose products are represented on our website, harmless against all damages. *Micro Commercial Components Corp.* products are sold subject to the general terms and conditions of commercial sale, as published at <https://www.mccsemi.com/Home/TermsAndConditions>.

**\*\*\*LIFE SUPPORT\*\*\***

MCC's products are not authorized for use as critical components in life support devices or systems without the express written approval of Micro Commercial Components Corporation.

**\*\*\*CUSTOMER AWARENESS\*\*\***

Counterfeiting of semiconductor parts is a growing problem in the industry. Micro Commercial Components (MCC) is taking strong measures to protect ourselves and our customers from the proliferation of counterfeit parts. MCC strongly encourages customers to purchase MCC parts either directly from MCC or from Authorized MCC Distributors who are listed by country on our web page cited below. Products customers buy either from MCC directly or from Authorized MCC Distributors are genuine parts, have full traceability, meet MCC's quality standards for handling and storage. **MCC will not provide any warranty coverage or other assistance for parts bought from Unauthorized Sources.** MCC is committed to combat this global problem and encourage our customers to do their part in stopping this practice by buying direct or from authorized distributors.