

SUMMARY



Image is for illustrative purpose only

Wires

Triax	1
Series	0S
Termination type	Male solder
IP rating	50
AWG wire size	0.00 - 0.00
Cable Ø	3.30 - 3.70 mm
Status	active
Matching parts	ERA.0S.650.CTL

Download

- [Request a quote](#)
- [Catalog](#)

TECHNICAL DETAILS

Mechanics

Shell Style/Model	FFA*: Straight plug, cable collet
Keying	Circular, male
Housing Material	Brass (chrome plated [SAE AMS 2460]) shell and collet nut, nickel plated [SAE AMS QQ N 290] brass latch sleeve and mid pieces
Weight	7.94 g

Performance

Configuration	0S.650 : 1 Triax (50 Ohm)
Insulator	T: PTFE
Rated Current	6 Amps

Specifications

Contact Type: Triaxial 50 Ohm (Solder)
Contact Dia.: 0.9 mm (0.035" in)
Vtest: 1200 V (AC), 1700 V (DC)
Impedance: 50 Ohm
VSWR: 1.03 + 0.34 * f/GHz
Cable type: RGT 178, RGT 174

Others

LEMO products and services are provided "as is". LEMO makes no warranties or representations with regard to LEMO product & services or use of them, express, implied or statutory, including for accuracy, completeness, or security. The user is fully responsible for his products and applications using LEMO components.

Endurance (Shell): 5000 mating cycles
 Temp (min / max): -55°C / +250°C
 Humidity (max): <=95% [at 60 deg C / 140 F]
 Vibration: 15 g [10 Hz - 2000 Hz]
 Shock Resistance: 100 g [6 ms]
 Climatical Category: 50/175/21
 Shielding (min): 75 dB (10 MHz)
 Shielding (min): 40 dB (1 GHz)
 Salt Spray Corrosion: >144 hr

DRAWINGS

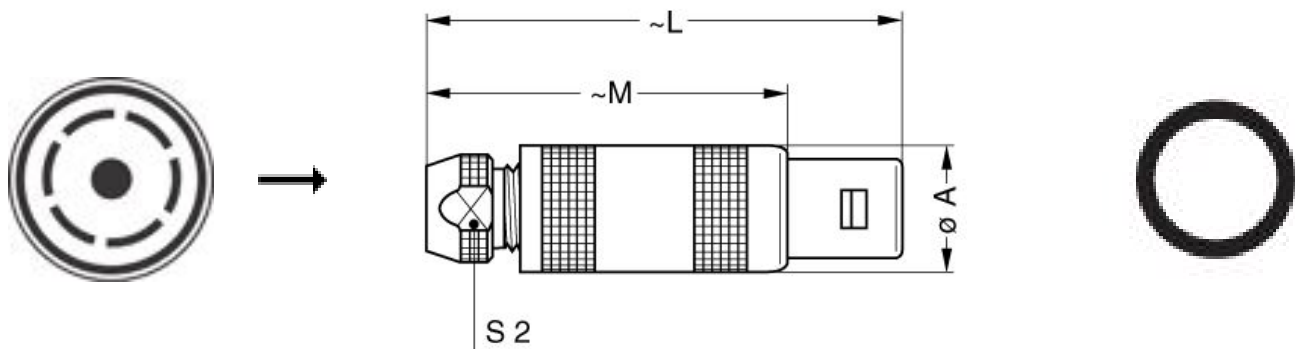

Dimensions

	A	L	M	S2
mm.	9	34.5	24.5	6.5
in.	0,35	1,36	0,96	0,26

RECOMMENDED BY LEMO

Tools

Spanner wrench: [DCD.0S.ZZZ.PA065](#)

LEMO products and services are provided "as is". LEMO makes no warranties or representations with regard to LEMO product & services or use of them, express, implied or statutory, including for accuracy, completeness, or security. The user is fully responsible for his products and applications using LEMO components.

LEMO products and services are provided "as is". LEMO makes no warranties or representations with regard to LEMO product & services or use of them, express, implied or statutory, including for accuracy, completeness, or security. The user is fully responsible for his products and applications using LEMO components.