

SF2193E

**1228 MHz
SAW Filter**

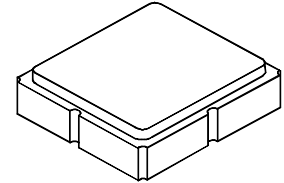

SM3030-8

- **Low-loss SAW Filter for GPS Receiver**
- **Surface-mount 3.0 x 3.0 mm Package**
- **Complies with Directive 2002/95/EC (RoHS)**
- **Moisture Sensitivity Level: 1**

Absolute Maximum Ratings

Rating	Value	Units
Input Power Level	5	dBm
DC Voltage on any Non-ground Terminal	3	V
Operating Temperature Range	-30 to +105	°C
Storage Temperature Range in Tape and Reel	-40 to +85	°C
Maximum Soldering Profile, 5 cycles/10 seconds maximum	265	°C

Electrical Characteristics

Characteristic	Sym	Notes	Min	Typ	Max	Min	Typ	Max	Units
			-30 to +85°C			-30 to +105°C			
Center Frequency	f_C			1228			1228		MHz
Insertion Loss, 1218 to 1238 MHz	IL			3.4	4.4		3.4	4.7	dB
Amplitude Ripple, 1218 to 1238 MHz				0.9	1.7		0.9	2.0	dB
Attenuation, 0 dB Reference:									dB
0 to 1088 MHz			40	52		40	52		
1088 to 1178 MHz			32	50		30	50		
1178 to 1190 MHz			15	50		14	50		
1268 to 1288 MHz			13	29		13	29		
1288 to 1378 MHz			30	41		30	41		
1378 to 1480 MHz			36	54		36	54		
1480 to 2500 MHz			28	47		28	47		
2500 to 4000 MHz			13	20		13	20		
Source Impedance, Unbalanced	Z_S			50			50		Ω
Load Impedance, Balanced	Z_L			50			50		
Case Style	SM3030-8 3.0 x 3.0 mm Nominal Footprint								
Lid Symbolization, Y=year, WW=week, S=shift, dot=pin 1 indicator	906, <u>YWWS</u>								

Electrical Connections

	Connection	Terminals
	Unbalanced Input	2
	Balanced Output	5, 7
	Ground	All Others

Dot Indicates Pin 1



CAUTION: Electrostatic Sensitive Device. Observe precautions for handling.

NOTES:

1. The design, manufacturing process, and specifications of this device are subject to change.
2. US or International patents may apply.
3. RoHS compliant from the first date of manufacture.

Filter Wideband Response

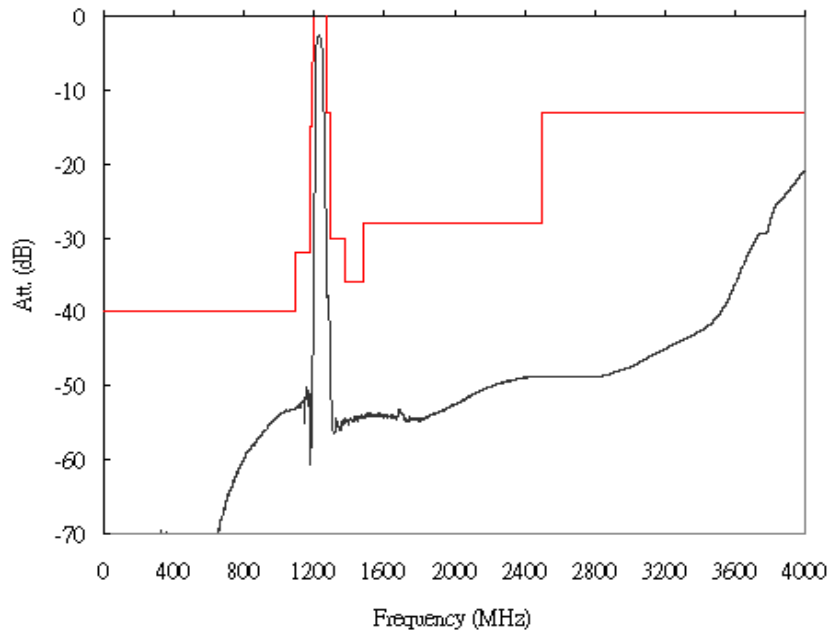

Filter Passband Response

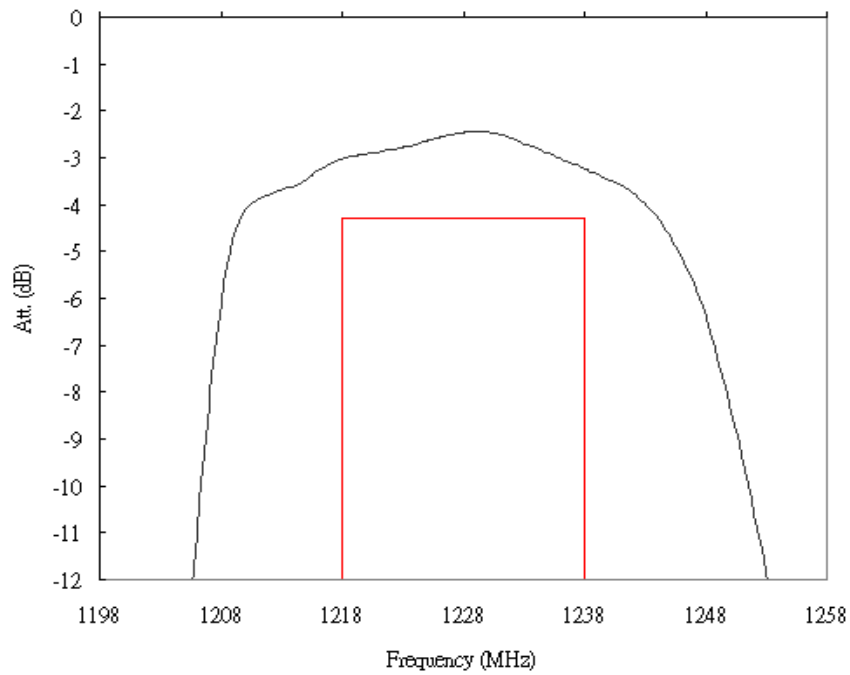

Filter Near-in Response

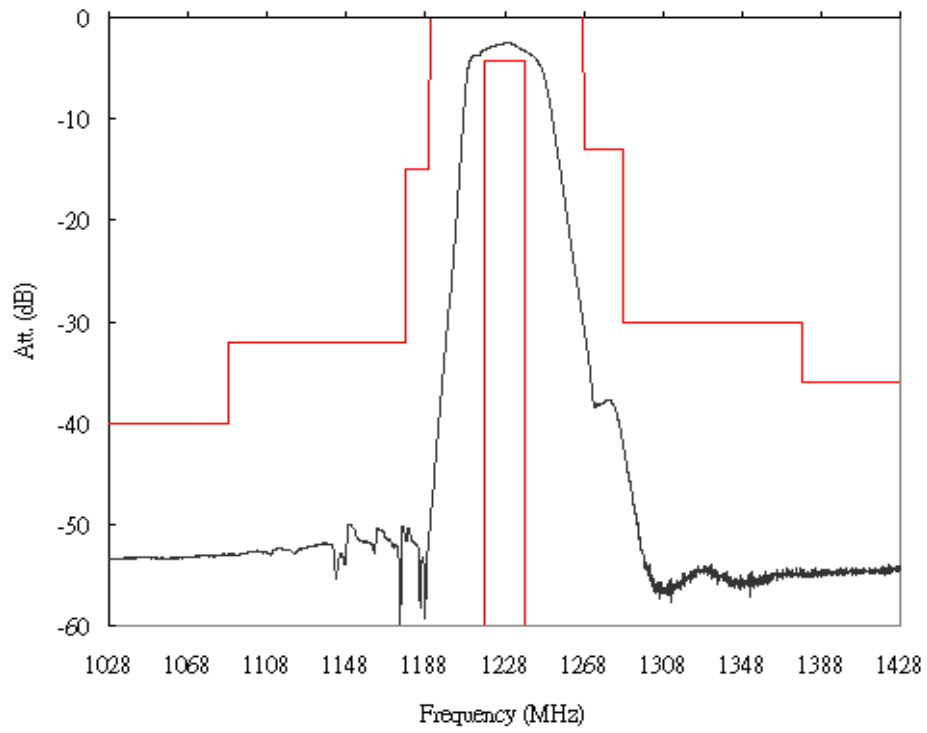

8-Terminal Ceramic Surface-Mount Case 3.0 X 3.0 mm Nominal Footprint

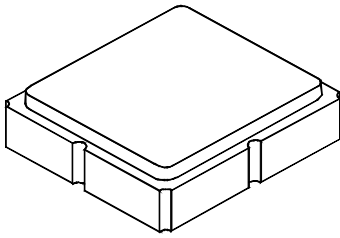

Case and PCB Footprint Dimensions

Dimension	mm			Inches		
	Min	Nom	Max	Min	Nom	Max
A	2.87	3.0	3.13	0.113	0.118	0.123
B	2.87	3.0	3.13	0.113	0.118	0.123
C	1.14	1.27	1.40	0.045	0.050	0.055
D	0.79	0.92	1.05	0.031	0.036	0.041
E	0.62	0.75	0.88	0.024	0.029	0.034
F	0.47	0.60	0.73	0.018	0.024	0.029
G	0.47	0.60	0.73	0.018	0.024	0.029
H	1.07	1.20	1.33	0.042	0.047	0.052
I		3.19			0.126	
J		0.81			0.032	
K		0.96			0.038	
L		0.81			0.032	
M		1.39			0.055	
N		0.23			0.009	
O		0.38			0.015	

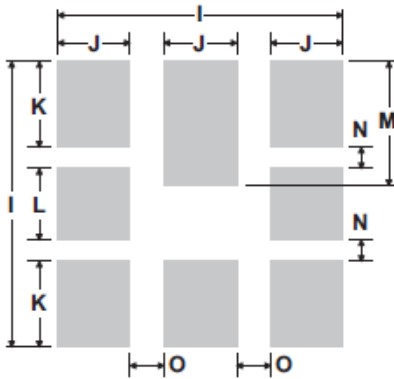

PCB Footprint Top View

Case Materials

Materials	
Solder Pad Plating	0.3 to 1.0 μm Gold over 1.27 to 8.89 μm Nickel
Lid Plating	2.0 to 3.0 μm Nickel
Body	Al_2O_3 Ceramic

TOP VIEW

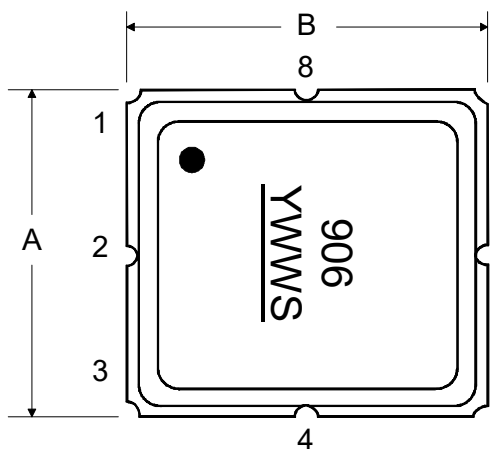

BOTTOM VIEW

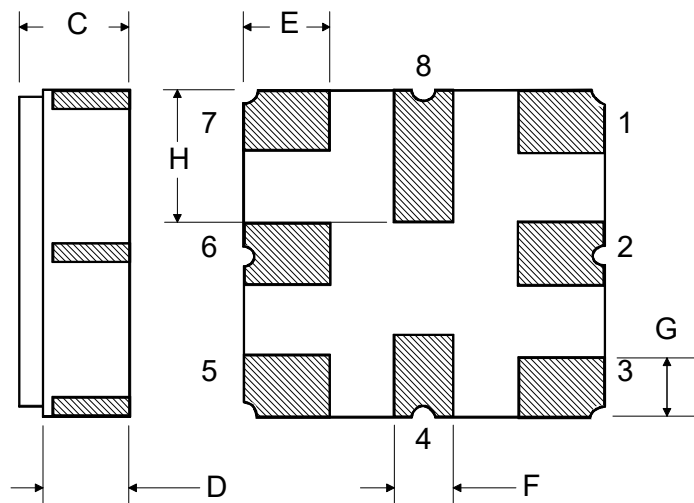

Tape and Reel Specifications

Tape and Reel Standard per ANSI/EIA-481

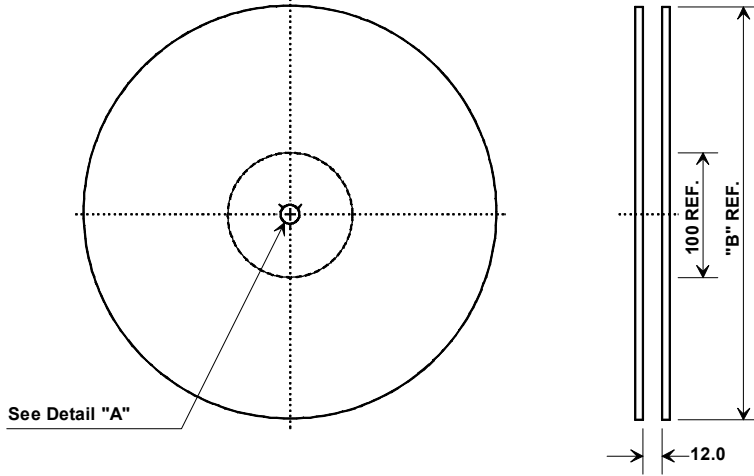

"B"		Quantity Per Reel
Inches	millimeters	
7	178	500
13	330	3000

See Detail "A"

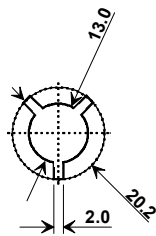

Carrier Tape Dimensions	
Ao	3.35 mm
Bo	3.35 mm
Ko	1.4 mm
Pitch	8.0 mm
W	12.0 mm

COMPONENT ORIENTATION and DIMENSIONS

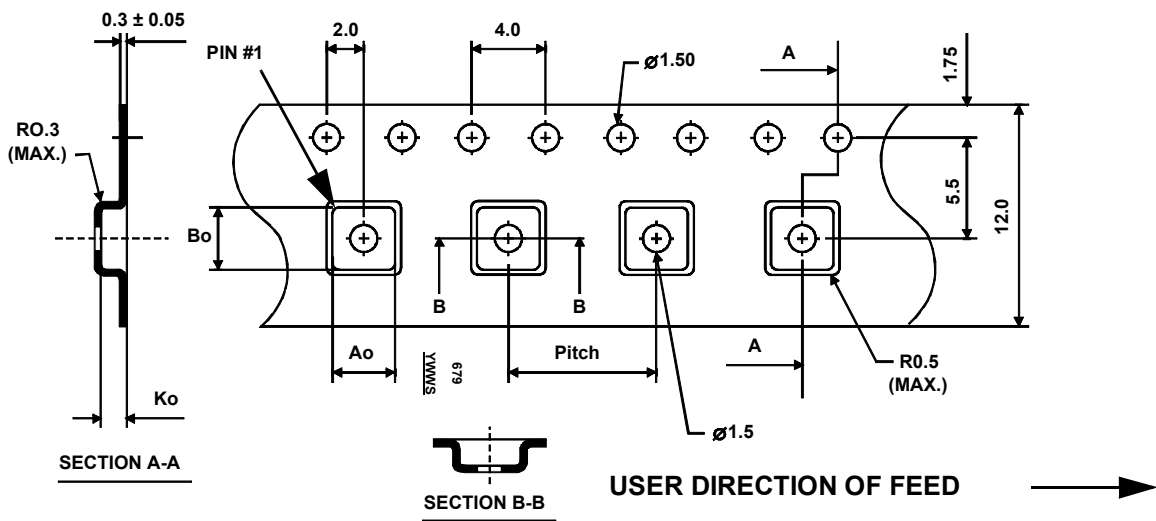

Recommended Reflow Profile

1. Preheating shall be fixed at 150~180°C for 60~90 seconds.
2. Ascending time to preheating temperature 150°C shall be 30 seconds min.
3. Heating shall be fixed at 220°C for 50~80 seconds and at 260°C +0/-5°C peak (10 seconds).
4. Time: 5 times maximum.

