

XLamp® XP-G LEDs

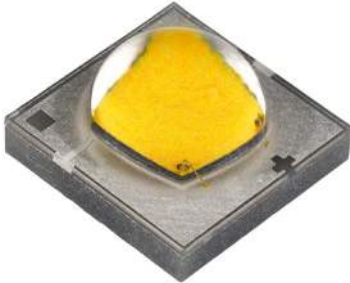

PRODUCT DESCRIPTION

The XLamp® XP-G LED delivers unprecedented levels of light output and efficacy for a single die LED. The XLamp XP-G LED continues Cree LED’s history of innovation in LEDs for lighting applications with wide viewing angle, symmetrical package, unlimited floor life and electrically neutral thermal path.

XLamp XP-G LEDs are the ideal choice for lighting applications where high light output and maximum efficacy are required, such as LED light bulbs, outdoor lighting, portable lighting, indoor lighting and solar-powered lighting.

FEATURES

- Available in white, outdoor white and 80-CRI, 85-CRI and 90-CRI white
- ANSI-compatible chromaticity bins
- Maximum drive current: 1500 mA
- Low thermal resistance: 2 °C/W
- Wide viewing angle: 130°
- Unlimited floor life at ≤ 30 °C/85% RH
- Reflow solderable - JEDEC J-STD-020C
- Electrically neutral thermal path
- RoHS and REACH compliant
- UL® recognized component (E349212)

TABLE OF CONTENTS

Characteristics	2
Order Codes Suggested for New Designs....	3
Relative Spectral Power Distribution	7
Relative Flux vs. Junction Temperature.....	7
Electrical Characteristics.....	8
Relative Flux vs. Current.....	8
Relative Chromaticity vs Current and Temperature	9
Typical Spatial Distribution.....	10
Thermal Design	10
Performance Groups – Luminous Flux.....	11
Performance Groups – Chromaticity.....	12
Standard Cool White Kits Plotted on ANSI Standard Chromaticity Regions	15
Standard Warm and Neutral White Kits Plotted on ANSI Standard Chromaticity Regions.....	16
Standard Chromaticity Kits	18
Bin and Order Code Formats.....	19
Reflow Soldering Characteristics.....	20
Notes	21
Mechanical Dimensions	23
Tape and Reel.....	25
Packaging.....	27
Appendix - Order Codes Not For New Designs.....	28



Cree LED / 4001 E. Hwy. 54, Suite 2000 / Durham, NC 27709 USA / +1.919.313.5330 / www.cree-led.com

CHARACTERISTICS

Characteristics	Unit	Minimum	Typical	Maximum
Thermal resistance, junction to solder point*	°C/W		2	
Viewing angle (FWHM)	degrees		130	
Temperature coefficient of voltage	mV/°C		-1.3	
ESD withstand voltage (HBM per Mil-Std-883D)	V			8000
DC forward current	mA			1500
Reverse voltage	V			1
Forward voltage (@ 350 mA, 25 °C)	V		2.75	3.1
Forward voltage (@ 700 mA, 25 °C)	V		2.88	
Forward voltage (@ 1000 mA, 25 °C)	V		2.97	
Forward voltage (@ 1500 mA, 25 °C)	V		3.10	
LED junction temperature	°C			150

* Thermal resistance measurement performed as per JEDEC JESD51-14 standard. See the [Thermal Resistance Measurement application note](#) for more details.

ORDER CODES SUGGESTED FOR NEW DESIGNS ($T_j = 25\text{ }^\circ\text{C}$)

The following table provides order codes for XLamp XP-G LEDs. For a complete description of the order code nomenclature, please see the Bin and Order Code Formats section (page 19). For definitions of the chromaticity kits, please see the Standard Chromaticity Kits section (page 18).

Chromaticity		Minimum Luminous Flux (lm) @ 350 mA		Order Codes
Kit	CCT	Code	Flux (lm)	70 CRI Typical
51	6200 K	S6	180	XPGWHT-L1-0000-00N51
		S5	172	XPGWHT-L1-0000-00M51
		S4	164	XPGWHT-L1-0000-00L51
53	6000 K	S6	180	XPGWHT-L1-0000-00N53
		S5	172	XPGWHT-L1-0000-00M53
		S4	164	XPGWHT-L1-0000-00L53
50	6200 K	S6	180	XPGWHT-L1-0000-00N50
		S5	172	XPGWHT-L1-0000-00M50
		S4	164	XPGWHT-L1-0000-00L50
E1	6500 K	S6	180	XPGWHT-L1-0000-00NE1
		S5	172	XPGWHT-L1-0000-00ME1
		S4	164	XPGWHT-L1-0000-00LE1
E2	5700 K	S7	188	XPGWHT-L1-0000-00PE2
		S6	180	XPGWHT-L1-0000-00NE2
		S5	172	XPGWHT-L1-0000-00ME2

Notes

- For additional order codes NOT recommended for new designs please see the Appendix section starting on page 28.
- Cree LED maintains a tolerance of $\pm 7\%$ on flux and power measurements, ± 0.005 on chromaticity (CCx, CCy) measurements and a tolerance of ± 2 on CRI measurements. See the Measurements section (page 21).
- XLamp XP-G LED order codes specify only a minimum flux bin and not a maximum. Cree LED may ship reels in flux bins higher than the minimum specified by the order code without advance notice. Shipments will always adhere to the chromaticity bin restrictions specified by the order code.

ORDER CODES SUGGESTED FOR NEW DESIGNS - CONTINUED

Chromaticity		Minimum Luminous Flux (lm) @ 350 mA		Order Codes		
Kit	CCT	Code	Flux (lm)	70 CRI Typical	75 CRI Typical	80 CRI Minimum
E3	5000 K	S5	172	XPGWHT-01-0000-00ME3		
		S4	164	XPGWHT-01-0000-00LE3	XPGWHT-L1-0000-00LE3	
		S3	156	XPGWHT-01-0000-00KE3	XPGWHT-L1-0000-00KE3	
F4	4750 K	S5	172	XPGWHT-01-0000-00MF4		
		S4	164	XPGWHT-01-0000-00LF4	XPGWHT-L1-0000-00LF4	
		S3	156	XPGWHT-01-0000-00KF4	XPGWHT-L1-0000-00KF4	
E4	4500 K	S4	164	XPGWHT-01-0000-00LE4	XPGWHT-L1-0000-00LE4	
		S3	156	XPGWHT-01-0000-00KE4	XPGWHT-L1-0000-00KE4	
		S2	148		XPGWHT-L1-0000-00JE4	
F5	4250 K	S4	164	XPGWHT-01-0000-00LF5	XPGWHT-L1-0000-00LF5	
		S3	156	XPGWHT-01-0000-00KF5	XPGWHT-L1-0000-00KF5	
		S2	148		XPGWHT-L1-0000-00JF5	
E5	4000 K	S4	164	XPGWHT-01-0000-00LE5	XPGWHT-L1-0000-00LE5	
		S3	156	XPGWHT-01-0000-00KE5	XPGWHT-L1-0000-00KE5	XPGWHT-H1-0000-00KE5
		S2	148		XPGWHT-L1-0000-00JE5	XPGWHT-H1-0000-00JE5
Z5	4000 K	S4	164		XPGWHT-L1-0000-00LZ5	
		S3	156		XPGWHT-L1-0000-00KZ5	XPGWHT-H1-0000-00KZ5
		S2	148		XPGWHT-L1-0000-00JZ5	XPGWHT-H1-0000-00JZ5

Notes

- For additional order codes NOT recommended for new designs please see the Appendix section starting on page 28.
- Cree LED maintains a tolerance of ±7% on flux and power measurements, ±0.005 on chromaticity (CCx, CCy) measurements and a tolerance of ±2 on CRI measurements. See the Measurements section (page 21).
- XLamp XP-G LED order codes specify only a minimum flux bin and not a maximum. Cree LED may ship reels in flux bins higher than the minimum specified by the order code without advance notice. Shipments will always adhere to the chromaticity bin restrictions specified by the order code.

ORDER CODES SUGGESTED FOR NEW DESIGNS - CONTINUED

Chromaticity		Minimum Luminous Flux (lm) @ 350 mA		Order Codes				
Kit	CCT	Code	Flux (lm)	70 CRI Typical	80 CRI Typical	80 CRI Minimum	85 CRI Minimum	90 CRI Minimum
F6	3750 K	S4	164	XPGWHT-01-0000-00LF6	XPGWHT-L1-0000-00LF6			
		S3	156	XPGWHT-01-0000-00KF6	XPGWHT-L1-0000-00KF6	XPGWHT-H1-0000-00KF6		
		S2	148		XPGWHT-L1-0000-00JF6	XPGWHT-H1-0000-00JF6		
E6	3500 K	S4	164	XPGWHT-01-0000-00LF6	XPGWHT-L1-0000-00LE6			
		S3	156	XPGWHT-01-0000-00KF6	XPGWHT-L1-0000-00KE6	XPGWHT-H1-0000-00KE6		
		S2	148		XPGWHT-L1-0000-00JE6	XPGWHT-H1-0000-00JE6		
Z6	3500 K	S4	164		XPGWHT-L1-0000-00LZ6			
		S3	156		XPGWHT-L1-0000-00KZ6	XPGWHT-H1-0000-00KZ6		
		S2	148		XPGWHT-L1-0000-00JZ6	XPGWHT-H1-0000-00JZ6		
F7	3250 K	S4	164		XPGWHT-L1-0000-00LF7			
		S3	156		XPGWHT-L1-0000-00KF7	XPGWHT-H1-0000-00KF7		
		S2	148		XPGWHT-L1-0000-00JF7	XPGWHT-H1-0000-00JF7		
E7	3000 K	S3	156		XPGWHT-L1-0000-00KE7			
		S2	148		XPGWHT-L1-0000-00JE7	XPGWHT-H1-0000-00JE7		
		R5	139		XPGWHT-L1-0000-00HE7	XPGWHT-H1-0000-00HE7		
		R4	130					
		R3	122				XPGWHT-P1-0000-00FE7	XPGWHT-U1-0000-00FE7
		R2	114				XPGWHT-P1-0000-00EE7	XPGWHT-U1-0000-00EE7
		Q5	107				XPGWHT-P1-0000-00DE7	XPGWHT-U1-0000-00DE7
Z7	3000 K	S3	156		XPGWHT-L1-0000-00KZ7			
		S2	148		XPGWHT-L1-0000-00JZ7	XPGWHT-H1-0000-00JZ7		
		R5	139		XPGWHT-L1-0000-00HZ7	XPGWHT-H1-0000-00HZ7		
		R4	130					
		R3	122				XPGWHT-P1-0000-00FZ7	XPGWHT-U1-0000-00FZ7
		R2	114				XPGWHT-P1-0000-00EZ7	XPGWHT-U1-0000-00EZ7
		Q5	107				XPGWHT-P1-0000-00DZ7	XPGWHT-U1-0000-00DZ7

Notes

- For additional order codes NOT recommended for new designs please see the Appendix section starting on page 28.
- Cree LED maintains a tolerance of ±7% on flux and power measurements, ±0.005 on chromaticity (CCx, CCy) measurements and a tolerance of ±2 on CRI measurements. See the Measurements section (page 21).
- XLamp XP-G LED order codes specify only a minimum flux bin and not a maximum. Cree LED may ship reels in flux bins higher than the minimum specified by the order code without advance notice. Shipments will always adhere to the chromaticity bin restrictions specified by the order code.

ORDER CODES SUGGESTED FOR NEW DESIGNS - CONTINUED

Chromaticity		Minimum Luminous Flux (lm) @ 350 mA		Order Codes				
Kit	CCT	Code	Flux (lm)	70 CRI Typical	80 CRI Typical	80 CRI Minimum	85 CRI Minimum	90 CRI Minimum
F8	2850 K	S3	156		XPGWHT-L1-0000-00KF8			
		S2	148		XPGWHT-L1-0000-00JF8	XPGWHT-H1-0000-00JF8		
		R5	139		XPGWHT-L1-0000-00HF8	XPGWHT-H1-0000-00HF8		
		R4	130					
		R3	122				XPGWHT-P1-0000-00FF8	XPGWHT-U1-0000-00FF8
		R2	114				XPGWHT-P1-0000-00EF8	XPGWHT-U1-0000-00EF8
		Q5	107				XPGWHT-P1-0000-00DF8	XPGWHT-U1-0000-00DF8
E8	2700 K	S3	156		XPGWHT-L1-0000-00KE8			
		S2	148		XPGWHT-L1-0000-00JE8			
		R5	139		XPGWHT-L1-0000-00HE8	XPGWHT-H1-0000-00HE8		
		R4	130			XPGWHT-H1-0000-00GE8		
		R3	122					
		R2	114				XPGWHT-P1-0000-00EE8	XPGWHT-U1-0000-00EE8
		Q5	107				XPGWHT-P1-0000-00DE8	XPGWHT-U1-0000-00DE8
Z8	2700 K	S3	156		XPGWHT-L1-0000-00KZ8			
		S2	148		XPGWHT-L1-0000-00JZ8			
		R5	139		XPGWHT-L1-0000-00HZ8	XPGWHT-H1-0000-00HZ8		
		R4	130			XPGWHT-H1-0000-00GZ8		
		R3	122					
		R2	114				XPGWHT-P1-0000-00EZ8	XPGWHT-U1-0000-00EZ8
		Q5	107				XPGWHT-P1-0000-00DZ8	XPGWHT-U1-0000-00DZ8
		Q4	100				XPGWHT-P1-0000-00CZ8	XPGWHT-U1-0000-00CZ8

Notes

- For additional order codes NOT recommended for new designs please see the Appendix section starting on page 28.
- Cree LED maintains a tolerance of ±7% on flux and power measurements, ±0.005 on chromaticity (CCx, CCy) measurements and a tolerance of ±2 on CRI measurements. See the Measurements section (page 21).
- XLamp XP-G LED order codes specify only a minimum flux bin and not a maximum. Cree LED may ship reels in flux bins higher than the minimum specified by the order code without advance notice. Shipments will always adhere to the chromaticity bin restrictions specified by the order code.

RELATIVE SPECTRAL POWER DISTRIBUTION

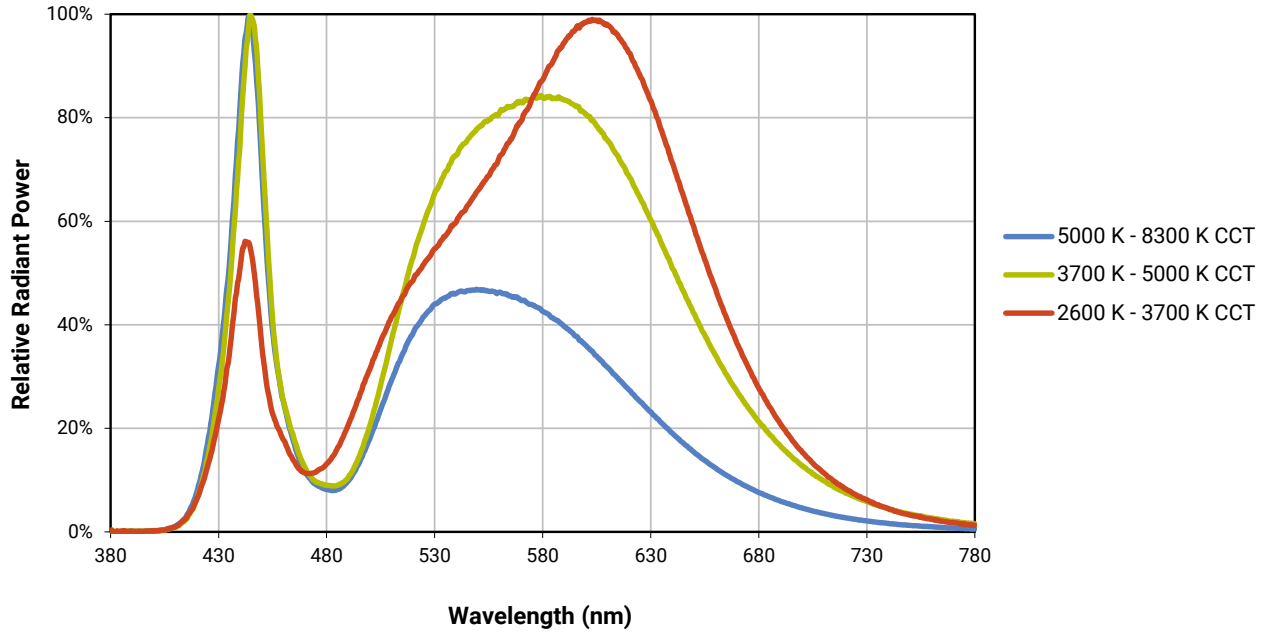

RELATIVE FLUX VS. JUNCTION TEMPERATURE ($I_f = 350$ mA)

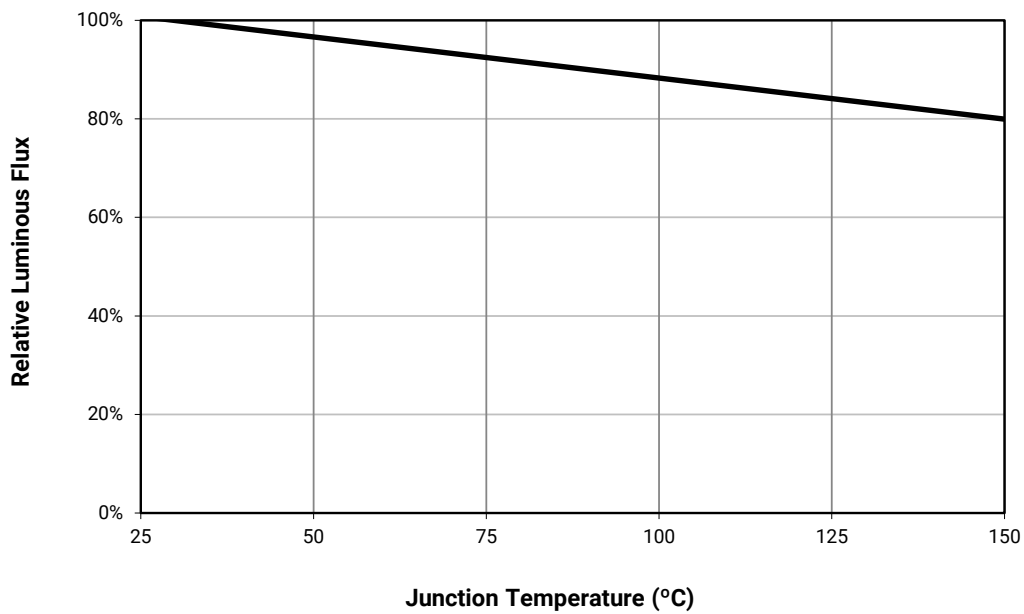

ELECTRICAL CHARACTERISTICS ($T_j = 25\text{ }^\circ\text{C}$)

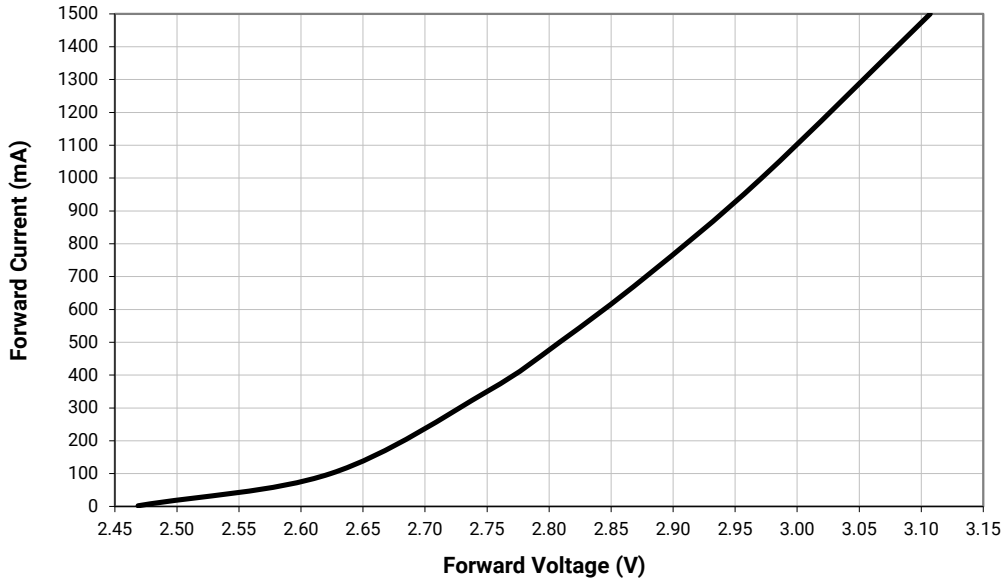

RELATIVE FLUX VS. CURRENT ($T_j = 25\text{ }^\circ\text{C}$)

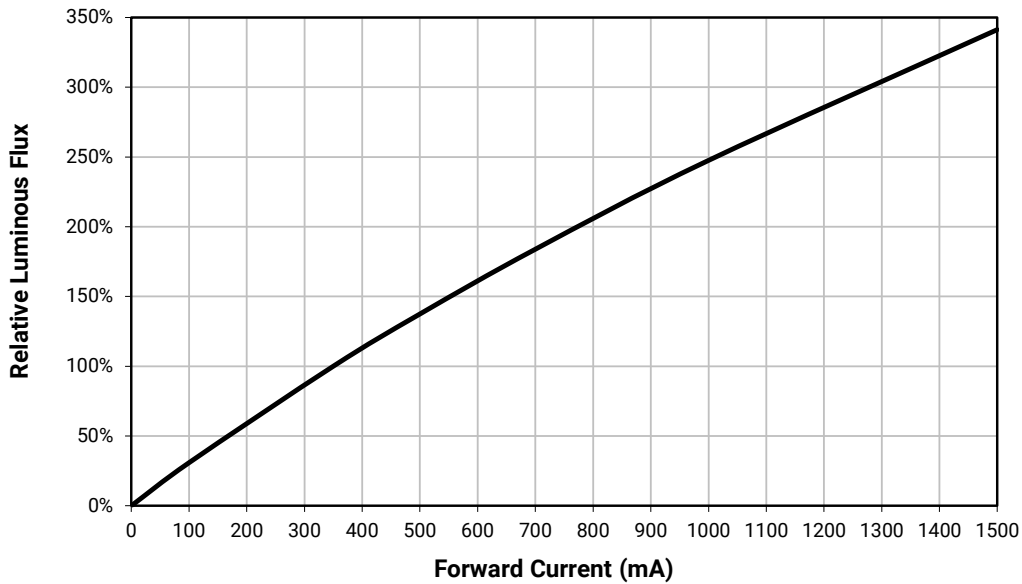

RELATIVE CHROMATICITY VS CURRENT AND TEMPERATURE (WARM WHITE*)

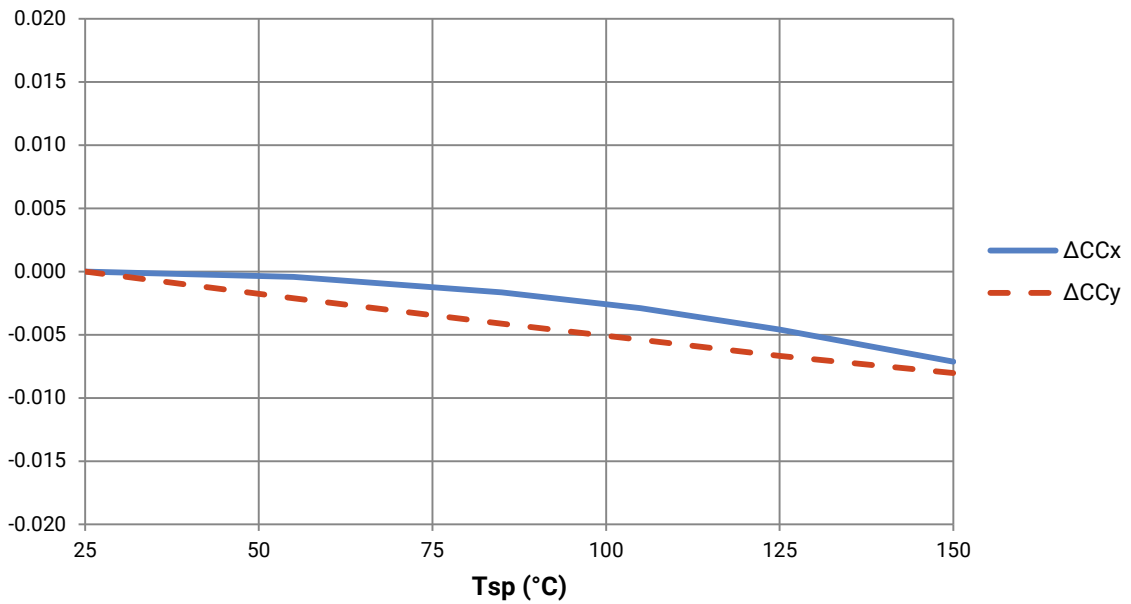
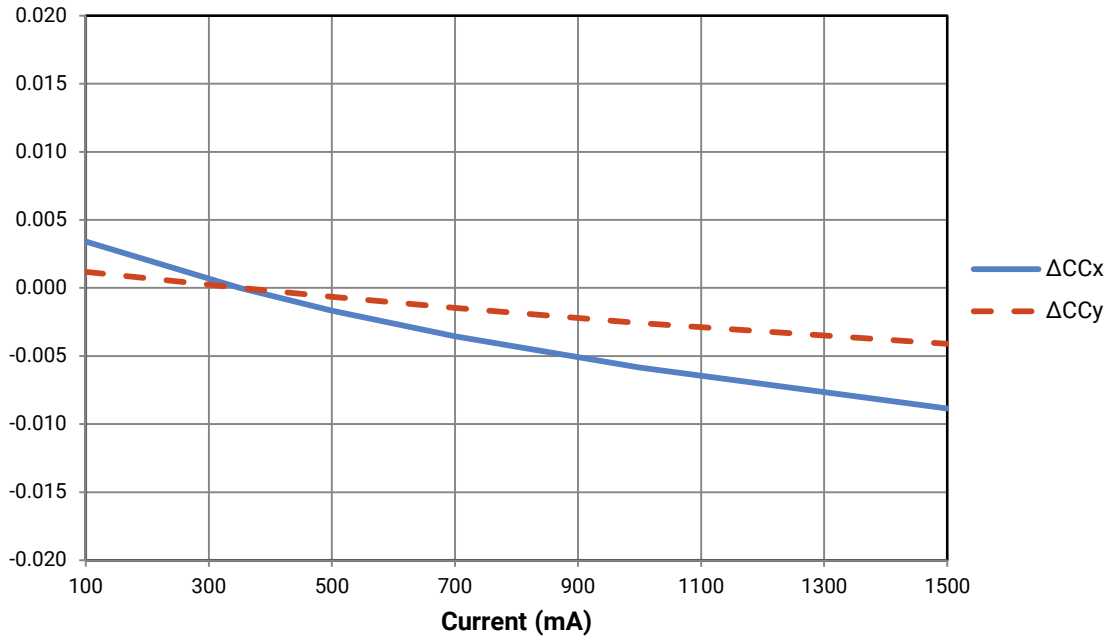

* Warm White XLamp XP-G LEDs have a typical CRI of 80.

TYPICAL SPATIAL DISTRIBUTION

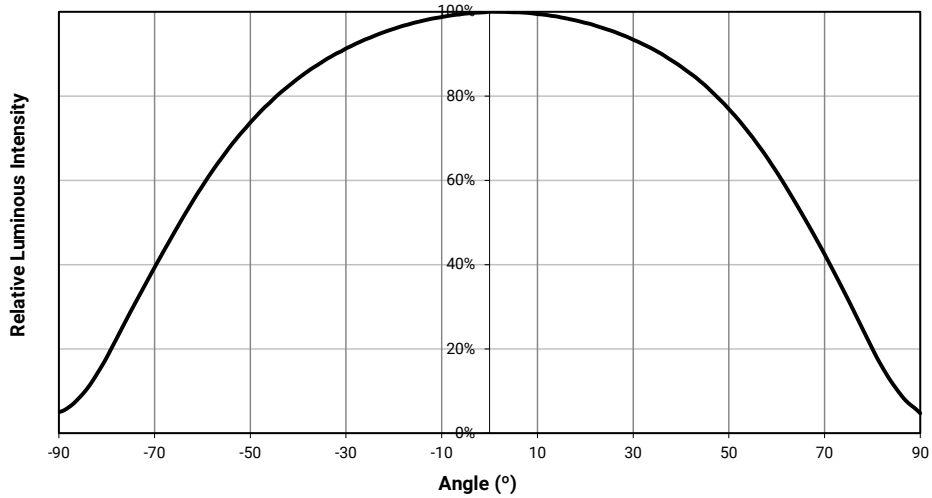

THERMAL DESIGN

The maximum forward current is determined by the thermal resistance between the LED junction and ambient. It is crucial for the end product to be designed in a manner that minimizes the thermal resistance from the solder point to ambient in order to optimize lamp life and optical characteristics.

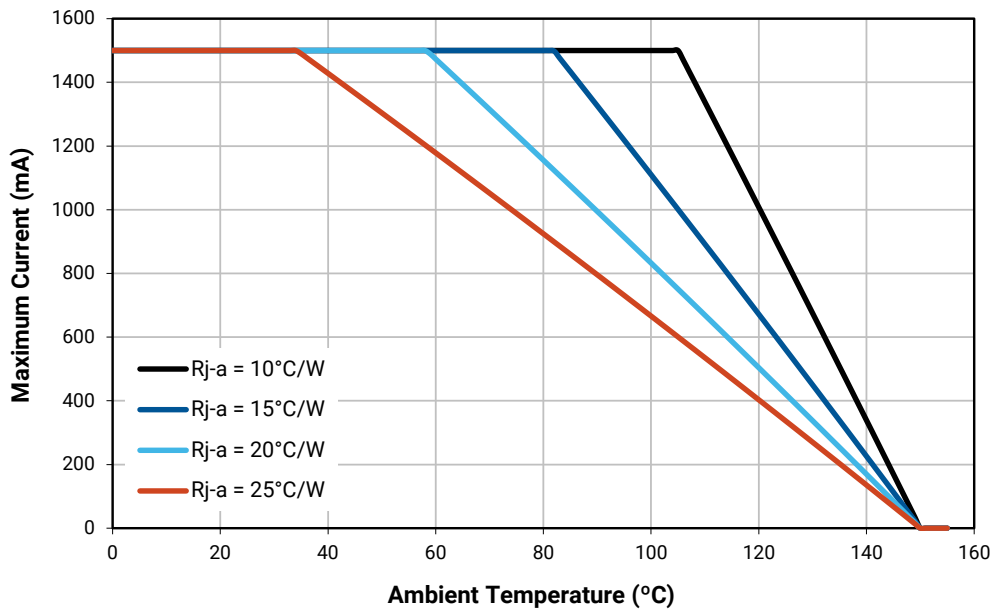

PERFORMANCE GROUPS – LUMINOUS FLUX

XLamp XP-G LEDs are tested for luminous flux and placed into one of the following luminous-flux groups:

Group Code	Minimum Luminous Flux (lm) @ 350 mA	Maximum Luminous Flux (lm) @ 350 mA
P2	67.2	73.9
P3	73.9	80.6
P4	80.6	87.4
Q2	87.4	93.9
Q3	93.9	100
Q4	100	107
Q5	107	114
R2	114	122
R3	122	130
R4	130	139
R5	139	148
S2	148	156
S3	156	164
S4	164	172
S5	172	180
S6	180	188

PERFORMANCE GROUPS – CHROMATICITY

Region	x	y	Region	x	y	Region	x	y	Region	x	y
0A	0.2950	0.2970	0B	0.2920	0.3060	0C	0.2984	0.3133	0D	0.2984	0.3133
	0.2920	0.3060		0.2895	0.3135		0.2962	0.3220		0.3048	0.3207
	0.2984	0.3133		0.2962	0.3220		0.3028	0.3304		0.3068	0.3113
	0.3009	0.3042		0.2984	0.3133		0.3048	0.3207		0.3009	0.3042
0R	0.2980	0.2880	0S	0.2895	0.3135	0T	0.2962	0.3220	0U	0.3037	0.2937
	0.2950	0.2970		0.2870	0.3210		0.2937	0.3312		0.3009	0.3042
	0.3009	0.3042		0.2937	0.3312		0.3005	0.3415		0.3068	0.3113
	0.3037	0.2937		0.2962	0.3220		0.3028	0.3304		0.3093	0.2993
1A	0.3048	0.3207	1B	0.3028	0.3304	1C	0.3115	0.3391	1D	0.3130	0.3290
	0.3130	0.3290		0.3115	0.3391		0.3205	0.3481		0.3213	0.3373
	0.3144	0.3186		0.3130	0.3290		0.3213	0.3373		0.3221	0.3261
	0.3068	0.3113		0.3048	0.3207		0.3130	0.3290		0.3144	0.3186
1R	0.3068	0.3113	1S	0.3005	0.3415	1T	0.3099	0.3509	1U	0.3144	0.3186
	0.3144	0.3186		0.3099	0.3509		0.3196	0.3602		0.3221	0.3261
	0.3161	0.3059		0.3115	0.3391		0.3205	0.3481		0.3231	0.3120
	0.3093	0.2993		0.3028	0.3304		0.3115	0.3391		0.3161	0.3059
2A	0.3215	0.3350	2B	0.3207	0.3462	2C	0.3290	0.3538	2D	0.3290	0.3417
	0.3290	0.3417		0.3290	0.3538		0.3376	0.3616		0.3371	0.3490
	0.3290	0.3300		0.3290	0.3417		0.3371	0.3490		0.3366	0.3369
	0.3222	0.3243		0.3215	0.3350		0.3290	0.3417		0.3290	0.3300
2R	0.3222	0.3243	2S	0.3196	0.3602	2T	0.3290	0.3690	2U	0.3290	0.3300
	0.3290	0.3300		0.3290	0.3690		0.3381	0.3762		0.3366	0.3369
	0.3290	0.3180		0.3290	0.3538		0.3376	0.3616		0.3361	0.3245
	0.3231	0.3120		0.3207	0.3462		0.3290	0.3538		0.3290	0.3180
3A	0.3371	0.3490	3B	0.3376	0.3616	3R	0.3366	0.3369	3S	0.3381	0.3762
	0.3451	0.3554		0.3463	0.3687		0.3440	0.3428		0.3480	0.3840
	0.3440	0.3427		0.3451	0.3554		0.3429	0.3307		0.3463	0.3687
	0.3366	0.3369		0.3371	0.3490		0.3361	0.3245		0.3376	0.3616
4A	0.3530	0.3597	4B	0.3548	0.3736	4C	0.3641	0.3804	4D	0.3615	0.3659
	0.3615	0.3659		0.3641	0.3804		0.3736	0.3874		0.3702	0.3722
	0.3590	0.3521		0.3615	0.3659		0.3702	0.3722		0.3670	0.3578
	0.3512	0.3465		0.3530	0.3597		0.3615	0.3659		0.3590	0.3521
4R	0.3512	0.3465	4S	0.3571	0.3907	4T	0.3668	0.3957	4U	0.3590	0.3521
	0.3590	0.3521		0.3668	0.3957		0.3771	0.4034		0.3670	0.3578
	0.3567	0.3389		0.3641	0.3804		0.3736	0.3874		0.3640	0.3440
	0.3495	0.3339		0.3548	0.3736		0.3641	0.3804		0.3567	0.3389

PERFORMANCE GROUPS – CHROMATICITY (CONTINUED)

Region	x	y	Region	x	y	Region	x	y	Region	x	y
5A1	0.3670	0.3578	5A2	0.3686	0.3649	5A3	0.3744	0.3685	5A4	0.3726	0.3612
	0.3686	0.3649		0.3702	0.3722		0.3763	0.3760		0.3744	0.3685
	0.3744	0.3685		0.3763	0.3760		0.3825	0.3798		0.3804	0.3721
	0.3726	0.3612		0.3744	0.3685		0.3804	0.3721		0.3783	0.3646
5B1	0.3702	0.3722	5B2	0.3719	0.3797	5B3	0.3782	0.3837	5B4	0.3763	0.3760
	0.3719	0.3797		0.3736	0.3874		0.3802	0.3916		0.3782	0.3837
	0.3782	0.3837		0.3802	0.3916		0.3869	0.3958		0.3847	0.3877
	0.3763	0.3760		0.3782	0.3837		0.3847	0.3877		0.3825	0.3798
5C1	0.3825	0.3798	5C2	0.3847	0.3877	5C3	0.3912	0.3917	5C4	0.3887	0.3836
	0.3847	0.3877		0.3869	0.3958		0.3937	0.4001		0.3912	0.3917
	0.3912	0.3917		0.3937	0.4001		0.4006	0.4044		0.3978	0.3958
	0.3887	0.3836		0.3912	0.3917		0.3978	0.3958		0.3950	0.3875
5D1	0.3783	0.3646	5D2	0.3804	0.3721	5D3	0.3863	0.3758	5D4	0.3840	0.3681
	0.3804	0.3721		0.3825	0.3798		0.3887	0.3836		0.3863	0.3758
	0.3863	0.3758		0.3887	0.3836		0.3950	0.3875		0.3924	0.3794
	0.3840	0.3681		0.3863	0.3758		0.3924	0.3794		0.3898	0.3716
6A1	0.3889	0.3690	6A2	0.3915	0.3768	6A3	0.3981	0.3800	6A4	0.3953	0.3720
	0.3915	0.3768		0.3941	0.3848		0.4010	0.3882		0.3981	0.3800
	0.3981	0.3800		0.4010	0.3882		0.4080	0.3916		0.4048	0.3832
	0.3953	0.3720		0.3981	0.3800		0.4048	0.3832		0.4017	0.3751
6B1	0.3941	0.3848	6B2	0.3968	0.3930	6B3	0.4040	0.3966	6B4	0.4010	0.3882
	0.3968	0.3930		0.3996	0.4015		0.4071	0.4052		0.4040	0.3966
	0.4040	0.3966		0.4071	0.4052		0.4146	0.4089		0.4113	0.4001
	0.4010	0.3882		0.4040	0.3966		0.4113	0.4001		0.4080	0.3916
6C1	0.4080	0.3916	6C2	0.4113	0.4001	6C3	0.4186	0.4037	6C4	0.4150	0.3950
	0.4113	0.4001		0.4146	0.4089		0.4222	0.4127		0.4186	0.4037
	0.4186	0.4037		0.4222	0.4127		0.4299	0.4165		0.4259	0.4073
	0.4150	0.3950		0.4186	0.4037		0.4259	0.4073		0.4221	0.3984
6D1	0.4017	0.3751	6D2	0.4048	0.3832	6D3	0.4116	0.3865	6D4	0.4082	0.3782
	0.4048	0.3832		0.4080	0.3916		0.4150	0.3950		0.4116	0.3865
	0.4116	0.3865		0.4150	0.3950		0.4221	0.3984		0.4183	0.3898
	0.4082	0.3782		0.4116	0.3865		0.4183	0.3898		0.4147	0.3814
7A1	0.4147	0.3814	7A2	0.4183	0.3898	7A3	0.4242	0.3919	7A4	0.4203	0.3833
	0.4183	0.3898		0.4221	0.3984		0.4281	0.4006		0.4242	0.3919
	0.4242	0.3919		0.4281	0.4006		0.4342	0.4028		0.4300	0.3939
	0.4203	0.3833		0.4242	0.3919		0.4300	0.3939		0.4259	0.3853

PERFORMANCE GROUPS – CHROMATICITY (CONTINUED)

Region	x	y	Region	x	y	Region	x	y	Region	x	y
7B1	0.4221	0.3984	7B2	0.4259	0.4073	7B3	0.4322	0.4096	7B4	0.4281	0.4006
	0.4259	0.4073		0.4299	0.4165		0.4364	0.4188		0.4322	0.4096
	0.4322	0.4096		0.4364	0.4188		0.4430	0.4212		0.4385	0.4119
	0.4281	0.4006		0.4322	0.4096		0.4385	0.4119		0.4342	0.4028
7C1	0.4342	0.4028	7C2	0.4385	0.4119	7C3	0.4449	0.4141	7C4	0.4403	0.4049
	0.4385	0.4119		0.4430	0.4212		0.4496	0.4236		0.4449	0.4141
	0.4449	0.4141		0.4496	0.4236		0.4562	0.4260		0.4513	0.4164
	0.4403	0.4049		0.4449	0.4141		0.4513	0.4164		0.4465	0.4071
7D1	0.4259	0.3853	7D2	0.4300	0.3939	7D3	0.4359	0.3960	7D4	0.4316	0.3873
	0.4300	0.3939		0.4342	0.4028		0.4403	0.4049		0.4359	0.3960
	0.4359	0.3960		0.4403	0.4049		0.4465	0.4071		0.4418	0.3981
	0.4316	0.3873		0.4359	0.3960		0.4418	0.3981		0.4373	0.3893
8A1	0.4373	0.3893	8A2	0.4418	0.3981	8A3	0.4475	0.3994	8A4	0.4428	0.3906
	0.4418	0.3981		0.4465	0.4071		0.4523	0.4085		0.4475	0.3994
	0.4475	0.3994		0.4523	0.4085		0.4582	0.4099		0.4532	0.4008
	0.4428	0.3906		0.4475	0.3994		0.4532	0.4008		0.4483	0.3919
8B1	0.4465	0.4071	8B2	0.4513	0.4164	8B3	0.4573	0.4178	8B4	0.4523	0.4085
	0.4513	0.4164		0.4562	0.4260		0.4624	0.4274		0.4573	0.4178
	0.4573	0.4178		0.4624	0.4274		0.4687	0.4289		0.4634	0.4193
	0.4523	0.4085		0.4573	0.4178		0.4634	0.4193		0.4582	0.4099
8C1	0.4582	0.4099	8C2	0.4634	0.4193	8C3	0.4695	0.4207	8C4	0.4641	0.4112
	0.4634	0.4193		0.4687	0.4289		0.4750	0.4304		0.4695	0.4207
	0.4695	0.4207		0.4750	0.4304		0.4813	0.4319		0.4756	0.4221
	0.4641	0.4112		0.4695	0.4207		0.4756	0.4221		0.4700	0.4126
8D1	0.4483	0.3919	8D2	0.4532	0.4008	8D3	0.4589	0.4021	8D4	0.4538	0.3931
	0.4532	0.4008		0.4582	0.4099		0.4641	0.4112		0.4589	0.4021
	0.4589	0.4021		0.4641	0.4112		0.4700	0.4126		0.4646	0.4034
	0.4538	0.3931		0.4589	0.4021		0.4646	0.4034		0.4593	0.3944

STANDARD COOL WHITE KITS PLOTTED ON ANSI STANDARD CHROMATICITY REGIONS

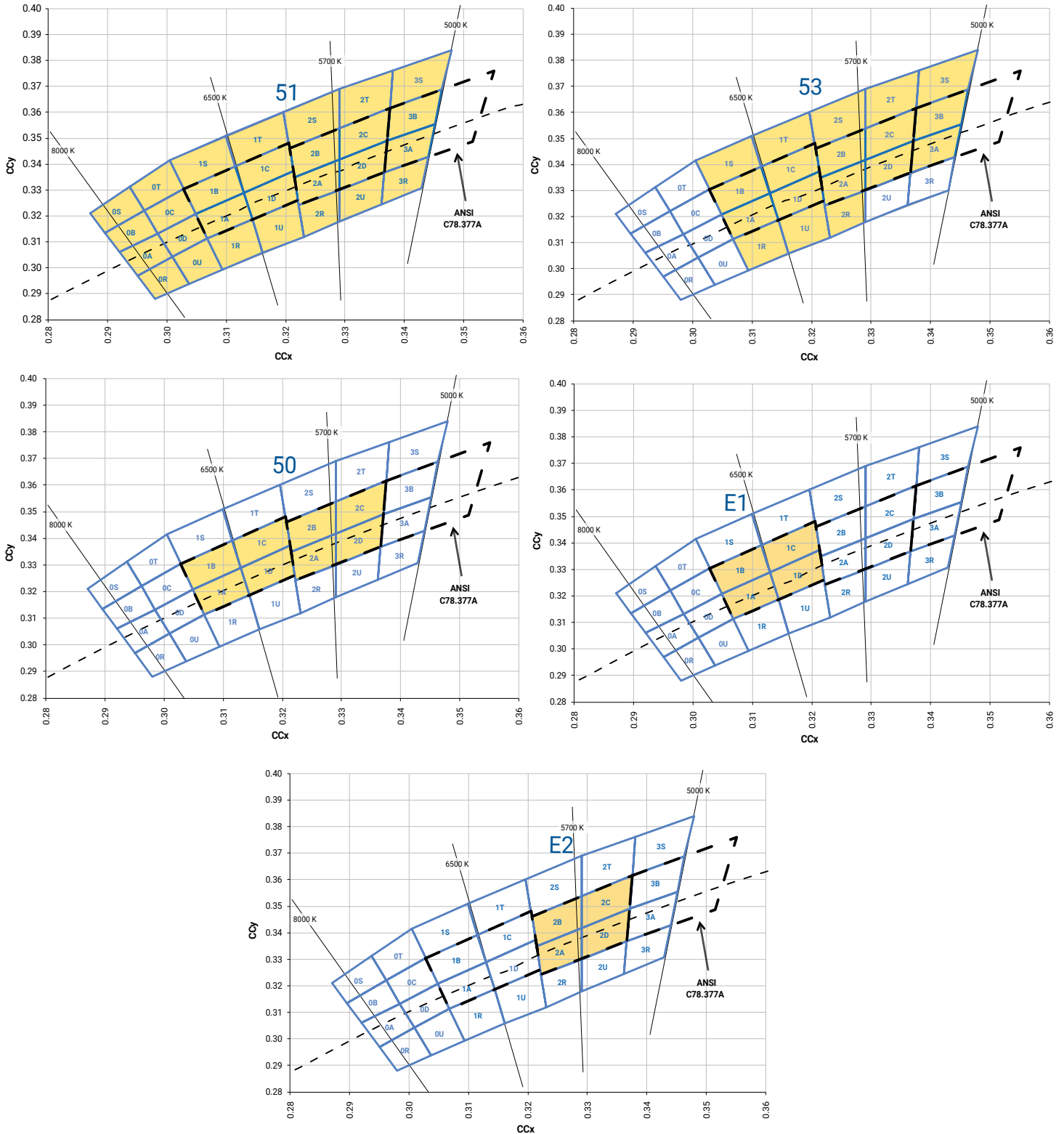

STANDARD WARM AND NEUTRAL WHITE KITS PLOTTED ON ANSI STANDARD CHROMATICITY REGIONS

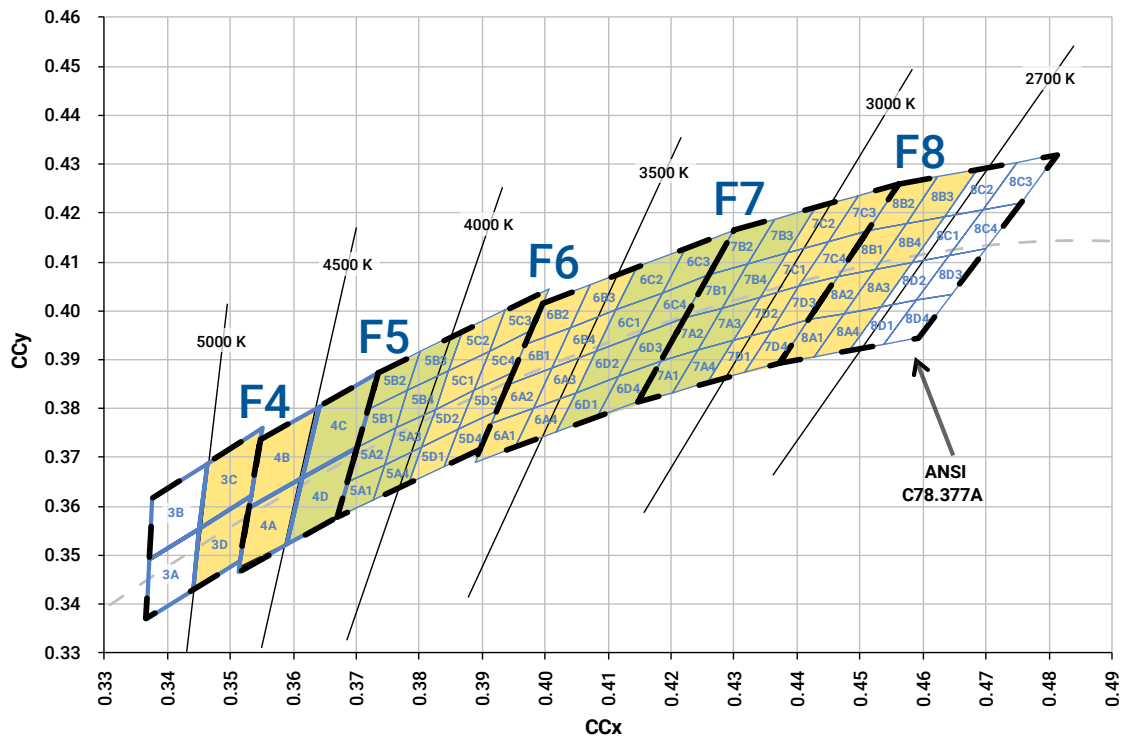
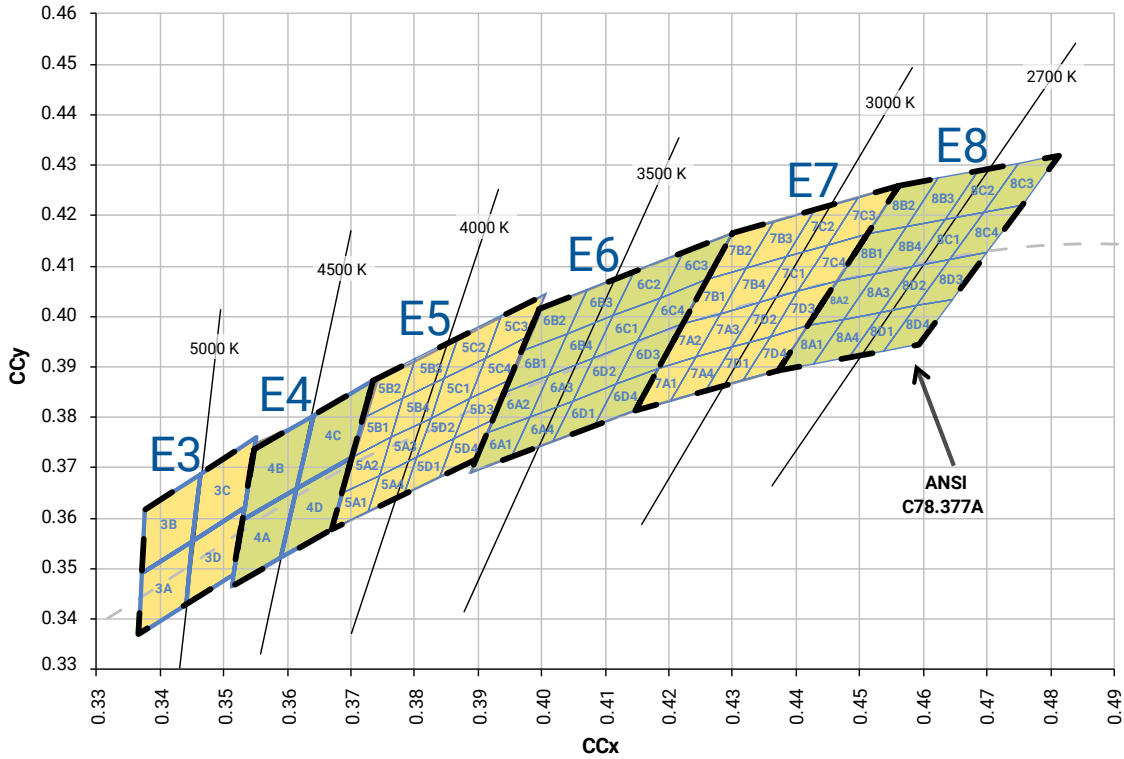

STANDARD WARM AND NEUTRAL WHITE KITS PLOTTED ON ANSI STANDARD CHROMATICITY REGIONS - CONTINUED

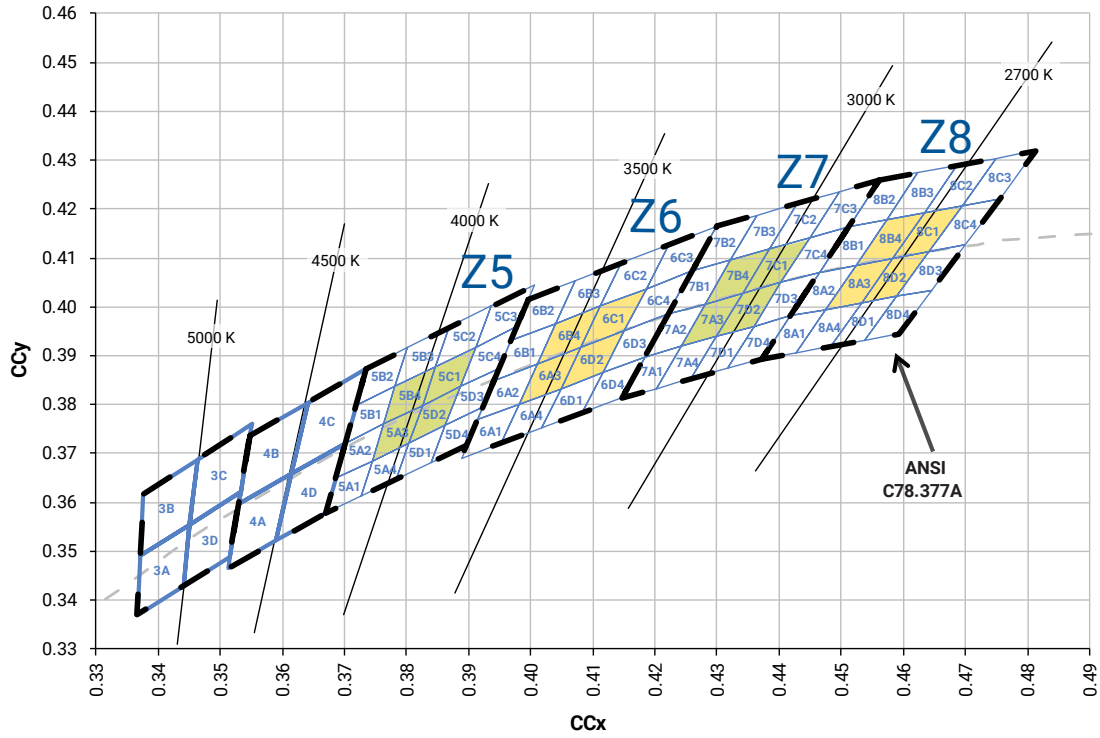

STANDARD CHROMATICITY KITS

The following table provides the chromaticity bins associated with chromaticity kits.

Color	CCT	Kit	Chromaticity Bins
Cool White	6200 K	E1	0A, 0B, 0C, 0D, 0R, 0S, 0T, 0U, 1A, 1B, 1C, 1D, 1R, 1S, 1T, 1U, 2A, 2B, 2C, 2D, 2R, 2S, 2T, 2U, 3A, 3B, 3R, 3S
	6000 K	E3	1A, 1B, 1C, 1D, 1R, 1S, 1T, 1U, 2A, 2B, 2C, 2D, 2R, 2S, 2T, 3A, 3B, 3S
	6200 K	E5	1A, 1B, 1C, 1D, 2A, 2B, 2C, 2D
	6500 K	E7	1A, 1B, 1C, 1D
	5700 K	E9	2A, 2B, 2C, 2D
Neutral White	5000 K	F1	3A, 3B, 3C, 3D
	4750 K	F3	3C, 3D, 4A, 4B
	4500 K	F5	4A, 4B, 4C, 4D
	4250 K	F7	4C, 4D, 5A1, 5A2, 5A3, 5A4, 5B1, 5B2, 5B3, 5B4
	4000 K	F9	5A1, 5A2, 5A3, 5A4, 5B1, 5B2, 5B3, 5B4, 5C1, 5C2, 5C3, 5C4, 5D1, 5D2, 5D3, 5D4
	4000 K	Z5	5A3, 5B4, 5C1, 5D2
Warm White	3750 K	F11	5C1, 5C2, 5C3, 5C4, 5D1, 5D2, 5D3, 5D4, 6A1, 6A2, 6A3, 6A4, 6B1, 6B2, 6B3, 6B4
	3500 K	E6	6A1, 6A2, 6A3, 6A4, 6B1, 6B2, 6B3, 6B4, 6C1, 6C2, 6C3, 6C4, 6D1, 6D2, 6D3, 6D4
	3500 K	Z6	6A3, 6B4, 6C1, 6D2
	3250 K	F7	6C1, 6C2, 6C3, 6C4, 6D1, 6D2, 6D3, 6D4, 7A1, 7A2, 7A3, 7A4, 7B1, 7B2, 7B3, 7B4
	3000 K	E7	7A1, 7A2, 7A3, 7A4, 7B1, 7B2, 7B3, 7B4, 7C1, 7C2, 7C3, 7C4, 7D1, 7D2, 7D3, 7D4
	3000 K	Z7	7A3, 7B4, 7C1, 7D2
	2850 K	F8	7C1, 7C2, 7C3, 7C4, 7D1, 7D2, 7D3, 7D4, 8A1, 8A2, 8A3, 8A4, 8B1, 8B2, 8B3, 8B4
	2700 K	E8	8A1, 8A2, 8A3, 8A4, 8B1, 8B2, 8B3, 8B4, 8C1, 8C2, 8C3, 8C4, 8D1, 8D2, 8D3, 8D4
	2700 K	Z8	8A3, 8B4, 8C1, 8D2

BIN AND ORDER CODE FORMATS

XP-G bin codes and order codes are configured in the following manner:

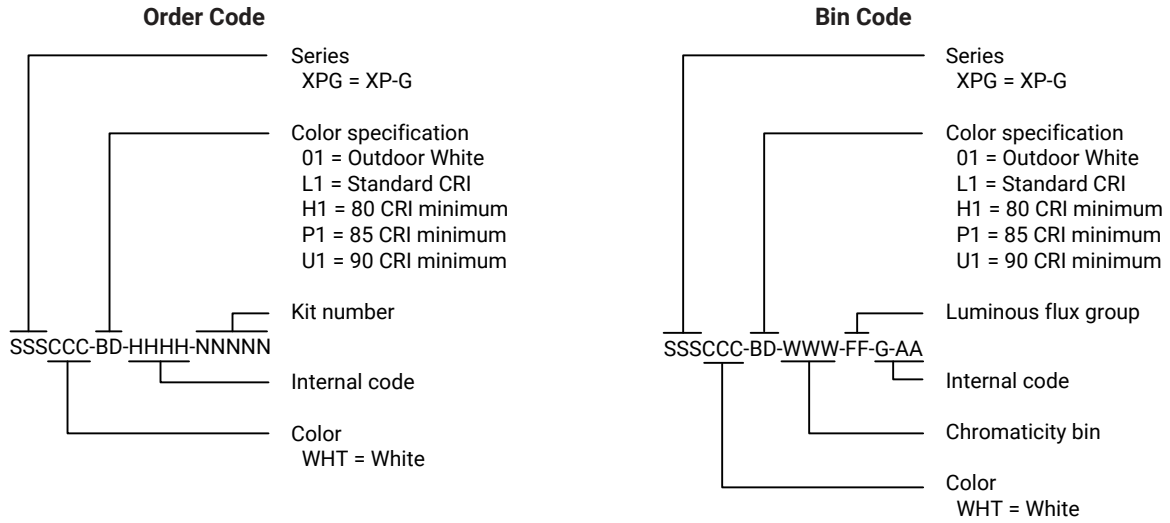

REFLOW SOLDERING CHARACTERISTICS

In testing, Cree LED has found XLamp XP-G LEDs to be compatible with JEDEC J-STD-020C, using the parameters listed below. As a general guideline, Cree LED recommends that users follow the recommended soldering profile provided by the manufacturer of the solder paste used, and therefore it is the lamp or luminaire manufacturer’s responsibility to determine applicable soldering requirements.

Note that this general guideline may not apply to all PCB designs and configurations of reflow soldering equipment.

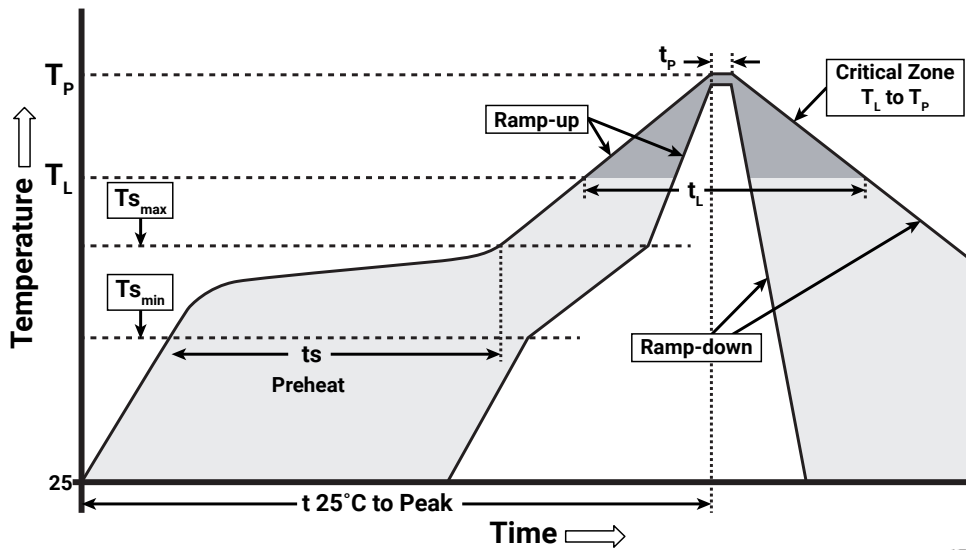

IPC/JEDEC J-STD-020C

Profile Feature	Lead-Free Solder
Average Ramp-Up Rate ($T_{s_{max}}$ to T_P)	1.2 °C/second
Preheat: Temperature Min ($T_{s_{min}}$)	120 °C
Preheat: Temperature Max ($T_{s_{max}}$)	170 °C
Preheat: Time ($t_{s_{min}}$ to $t_{s_{max}}$)	65-150 seconds
Time Maintained Above: Temperature (T_L)	217 °C
Time Maintained Above: Time (t_L)	45-90 seconds
Peak/Classification Temperature (T_P)	235 - 245 °C
Time Within 5 °C of Actual Peak Temperature (t_p)	20-40 seconds
Ramp-Down Rate	1 - 6 °C/second
Time 25 °C to Peak Temperature	4 minutes max.

Note: All temperatures refer to topside of the package, measured on the package body surface.

NOTES

Measurements

The luminous flux, radiant power, chromaticity, forward voltage and CRI measurements in this document are binning specifications only and solely represent product measurements as of the date of shipment. These measurements will change over time based on a number of factors that are not within Cree LED's control and are not intended or provided as operational specifications for the products. Calculated values are provided for informational purposes only and are not intended or provided as specifications.

Pre-Release Qualification Testing

Please read the [LED Reliability Overview](#) for details of the qualification process Cree LED applies to ensure long-term reliability for XLamp LEDs and details of Cree LED's pre-release qualification testing for XLamp LEDs.

Lumen Maintenance

Cree LED now uses standardized IES LM-80-08 and TM-21-11 methods for collecting long-term data and extrapolating LED lumen maintenance. For information on the specific LM-80 data sets available for this LED, refer to the public [LM-80 results document](#).

Please read the [Long-Term Lumen Maintenance application note](#) for more details on Cree LED's lumen maintenance testing and forecasting. Please read the [Thermal Management application note](#) for details on how thermal design, ambient temperature, and drive current affect the LED junction temperature.

Moisture Sensitivity

Cree LED recommends keeping XLamp LEDs in the provided, resealable moisture-barrier packaging (MBP) until immediately prior to soldering. Unopened MBPs that contain XLamp LEDs do not need special storage for moisture sensitivity.

Once the MBP is opened, XLamp XP-G LEDs may be stored as MSL 1 per JEDEC J-STD-033, meaning they have unlimited floor life in conditions of ≤ 30 °C/85% relative humidity (RH). Regardless of the storage condition, Cree LED recommends sealing any unsoldered LEDs in the original MBP.

RoHS Compliance

The levels of RoHS restricted materials in this product are below the maximum concentration values (also referred to as the threshold limits) permitted for such substances, or are used in an exempted application, in accordance with EU Directive 2011/65/EC (RoHS2), as implemented January 2, 2013. RoHS Declarations for this product can be obtained from your Cree LED representative or from the [Product Ecology](#) section of the Cree LED website.

REACH Compliance

REACH substances of very high concern (SVHCs) information is available for this product. Since the European Chemical Agency (ECHA) has published notice of their intent to frequently revise the SVHC listing for the foreseeable future, please contact a Cree LED representative to insure you get the most up-to-date REACH SVHC Declaration. REACH banned substance information (REACH Article 67) is also available upon request.

NOTES - CONTINUED

UL® Recognized Component

This product meets the requirements to be considered a UL Recognized Component with Level 4 enclosure consideration. The LED package or a portion thereof has been investigated as a fire and electrical enclosure per ANSI/UL 8750.

Vision Advisory

WARNING: Do not look at an exposed lamp in operation. Eye injury can result. For more information about LEDs and eye safety, please refer to the [LED Eye Safety application note](#).

MECHANICAL DIMENSIONS (T_A = 25 °C)

Thermal vias, if present, are not shown on these drawings.

All measurements are ±.13 mm unless otherwise indicated.

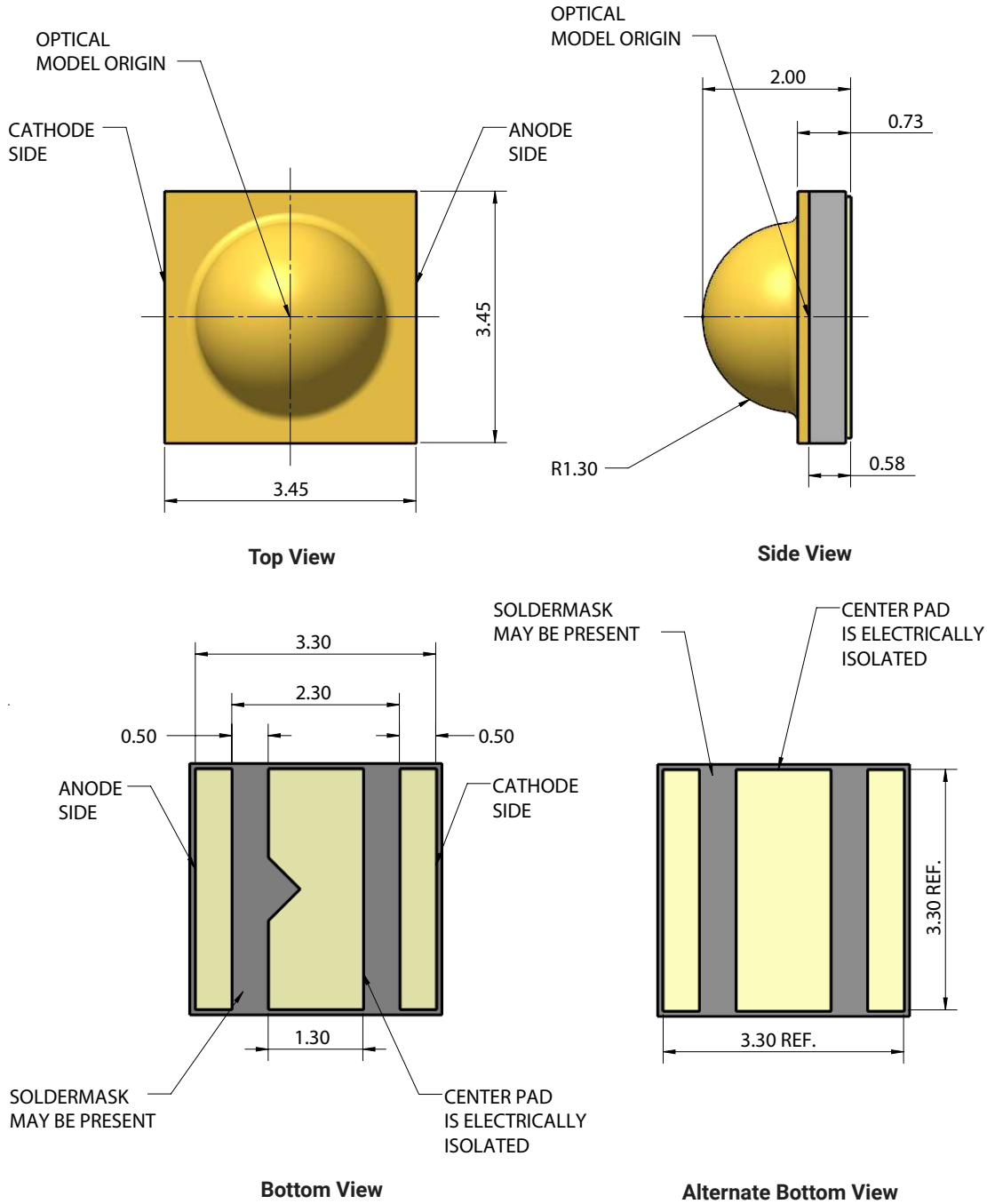

MECHANICAL DIMENSIONS - CONTINUED ($T_A = 25\text{ }^\circ\text{C}$)

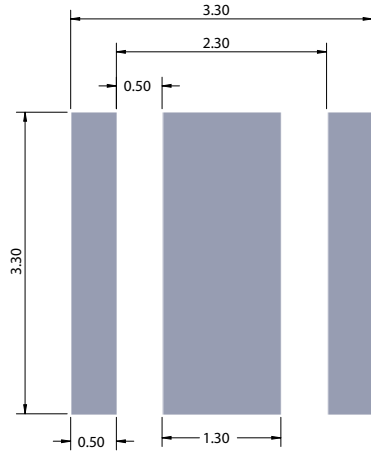

Recommended PCB Footprint

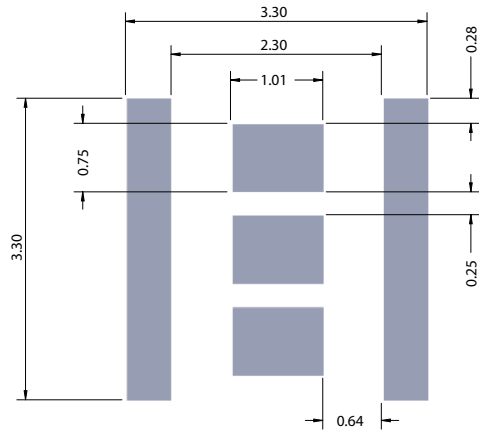

Recommended Stencil Opening

TAPE AND REEL

All Cree LED carrier tapes conform to EIA-481D, Automated Component Handling Systems Standard.

Except as noted, all dimensions in mm.

All measurements are ± 0.15 mm unless otherwise indicated.

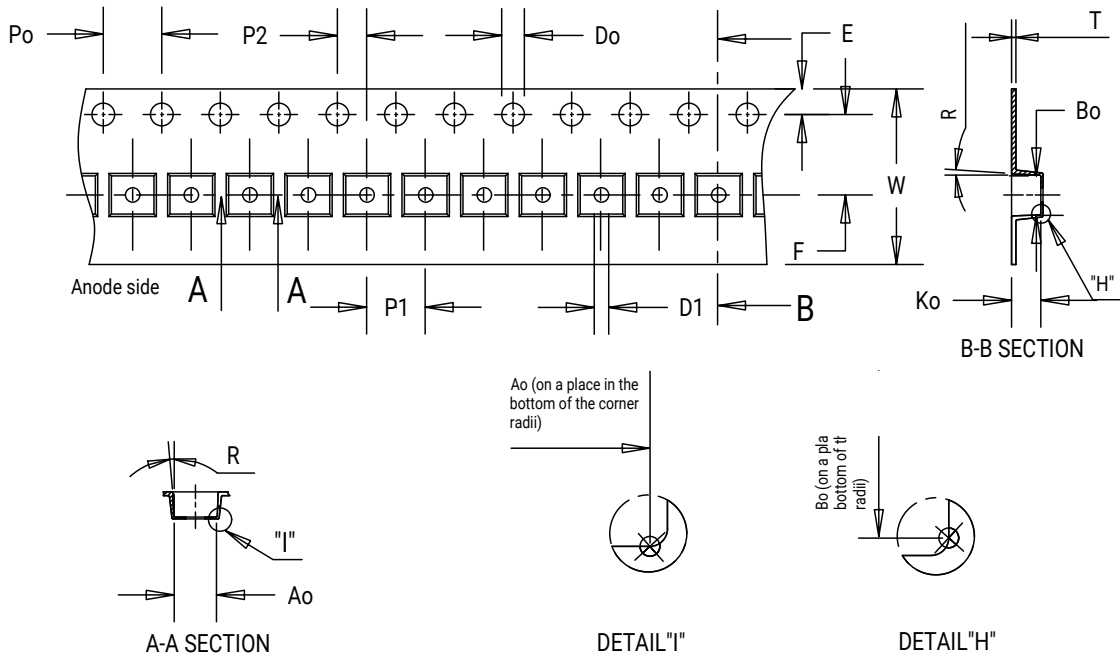

Item	Ao	Bo	Ko	Po	P1	P2	T	E	F	Do	D1	W	R
Dim.	3.75	3.75	2.10	4.00	8.00	2.00	0.30	1.75	5.50	1.50	1.50	12.00	8°

TAPE AND REEL - CONTINUED

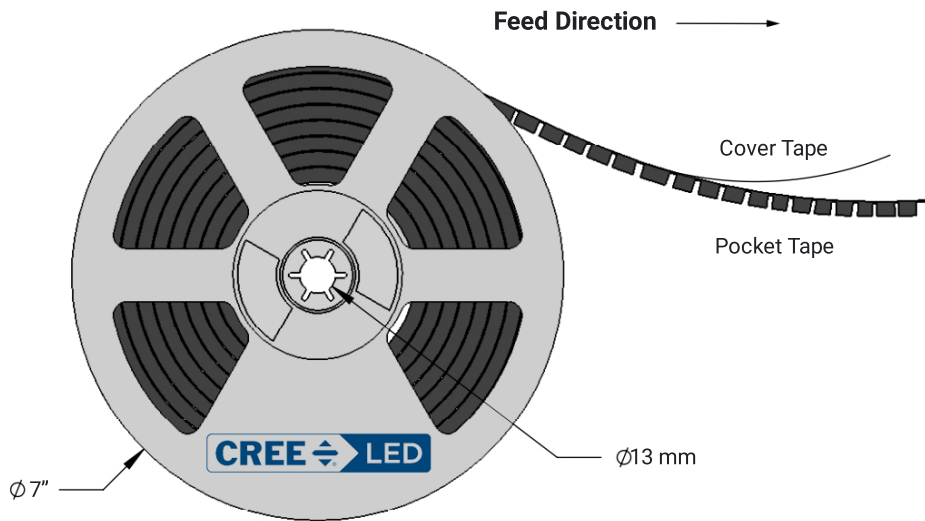
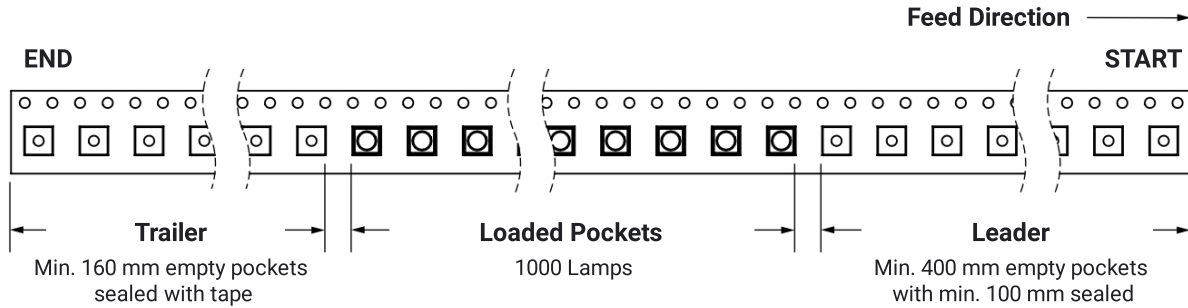

PACKAGING

Unpackaged Reel

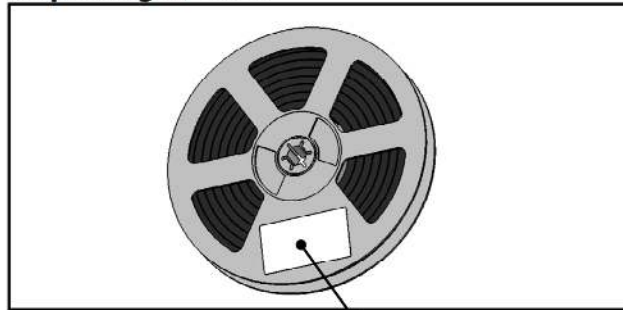

Label with Cree LED Bin Code, Quantity, Reel ID

Packaged Reel

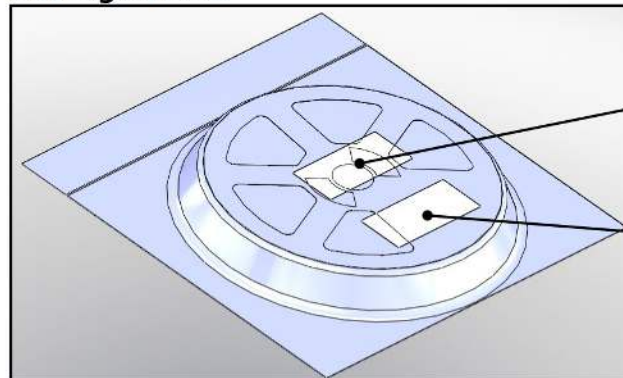

Label with Cree LED Order Code, Quantity, Reel ID, PO#

Label with Cree LED Bin Code, Quantity, Reel ID

Boxed Reel

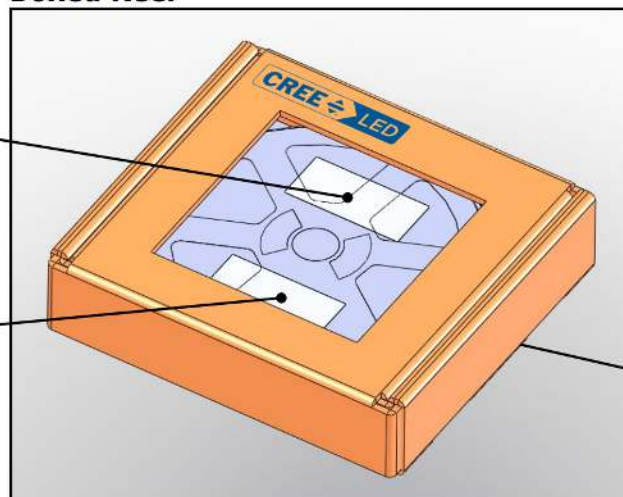

Label with Cree LED Order Code, Quantity, Reel ID, PO#

Label with Cree LED Bin Code, Quantity, Reel ID

Patent Label (on bottom of box)

APPENDIX - ORDER CODES NOT FOR NEW DESIGNS

The following order codes are active and valid order codes, but higher performance options are also available. Please see page 3 for order codes of XLamp XP-G LEDs that could serve as alternatives for the order codes set forth below.

Chromaticity		Minimum Luminous Flux (lm) @ 350 mA		Order Codes
Kit	CCT	Code	Flux (lm)	70 CRI Typical
51	6200 K	S3	156	XPGWHT-L1-0000-00K51
		S2	148	XPGWHT-L1-0000-00J51
		R5	139	XPGWHT-L1-0000-00H51
		R4	130	XPGWHT-L1-0000-00G51
		R3	122	XPGWHT-L1-0000-00F51
53	6000 K	S3	156	XPGWHT-L1-0000-00K53
		S2	148	XPGWHT-L1-0000-00J53
		R5	139	XPGWHT-L1-0000-00H53
		R4	130	XPGWHT-L1-0000-00G53
		R3	122	XPGWHT-L1-0000-00F53
50	6200 K	S3	156	XPGWHT-L1-0000-00K50
		S2	148	XPGWHT-L1-0000-00J50
		R5	139	XPGWHT-L1-0000-00H50
		R4	130	XPGWHT-L1-0000-00G50
		R3	122	XPGWHT-L1-0000-00F50
E1	6500 K	S3	156	XPGWHT-L1-0000-00KE1
		S2	148	XPGWHT-L1-0000-00JE1
		R5	139	XPGWHT-L1-0000-00HE1
		R4	130	XPGWHT-L1-0000-00GE1
		R3	122	XPGWHT-L1-0000-00FE1
E2	5700 K	S4	164	XPGWHT-L1-0000-00LE2
		S3	156	XPGWHT-L1-0000-00KE2
		S2	148	XPGWHT-L1-0000-00JE2
		R5	139	XPGWHT-L1-0000-00HE1
		R4	130	XPGWHT-L1-0000-00GE1
		R3	122	XPGWHT-L1-0000-00FE1

Notes

- Cree LED maintains a tolerance of ±7% on flux and power measurements, ±0.005 on chromaticity (CCx, CCy) measurements and a tolerance of ±2 on CRI measurements. See the Measurements section (page 21).
- XLamp XP-G LED order codes specify only a minimum flux bin and not a maximum. Cree LED may ship reels in flux bins higher than the minimum specified by the order code without advance notice. Shipments will always adhere to the chromaticity bin restrictions specified by the order code.

APPENDIX - ORDER CODES NOT FOR NEW DESIGNS - CONTINUED

The following order codes are active and valid order codes, but higher performance options are also available. Please see page 4 for order codes of XLamp XP-G LEDs that could serve as alternatives for the order codes set forth below.

Chromaticity		Minimum Luminous Flux (lm) @ 350 mA		Order Codes		
Kit	CCT	Code	Flux (lm)	70 CRI Minimum	75 CRI Typical	80 CRI Minimum
E3	5000 K	S2	148	XPGWHT-01-0000-00JE3	XPGWHT-L1-0000-00JE3	
		R5	139	XPGWHT-01-0000-00HE3	XPGWHT-L1-0000-00HE3	
		R4	130	XPGWHT-01-0000-00GE3	XPGWHT-L1-0000-00GE3	
		R3	122	XPGWHT-01-0000-00FE3	XPGWHT-L1-0000-00FE3	
		R2	114	XPGWHT-01-0000-00EE3	XPGWHT-L1-0000-00EE3	
		Q5	107		XPGWHT-L1-0000-00DE3	
F4	4750 K	S2	148	XPGWHT-01-0000-00JF4	XPGWHT-L1-0000-00JF4	
		R5	139	XPGWHT-01-0000-00HF4	XPGWHT-L1-0000-00HF4	
		R4	130	XPGWHT-01-0000-00GF4	XPGWHT-L1-0000-00GF4	
		R3	122	XPGWHT-01-0000-00FF4	XPGWHT-L1-0000-00FF4	
		R2	114	XPGWHT-01-0000-00EF4	XPGWHT-L1-0000-00EF4	
		Q5	107		XPGWHT-L1-0000-00DF4	
E4	4500 K	S2	148	XPGWHT-01-0000-00JE4		
		R5	139	XPGWHT-01-0000-00HE4	XPGWHT-L1-0000-00HE4	
		R4	130	XPGWHT-01-0000-00GE4	XPGWHT-L1-0000-00GE4	
		R3	122	XPGWHT-01-0000-00FE4	XPGWHT-L1-0000-00FE4	
		R2	114	XPGWHT-01-0000-00EE4	XPGWHT-L1-0000-00EE4	
		Q5	107		XPGWHT-L1-0000-00DE4	
		Q4	100		XPGWHT-L1-0000-00CE4	
F5	4250 K	S2	148	XPGWHT-01-0000-00JF5		
		R5	139	XPGWHT-01-0000-00HF5	XPGWHT-L1-0000-00HF5	
		R4	130	XPGWHT-01-0000-00GF5	XPGWHT-L1-0000-00GF5	
		R3	122	XPGWHT-01-0000-00FF5	XPGWHT-L1-0000-00FF5	
		R2	114	XPGWHT-01-0000-00EF5	XPGWHT-L1-0000-00EF5	
		Q5	107		XPGWHT-L1-0000-00DF5	
E5	4000 K	S2	148	XPGWHT-01-0000-00JE5		
		R5	139	XPGWHT-01-0000-00HE5	XPGWHT-L1-0000-00HE5	XPGWHT-H1-0000-00HE5
		R4	130	XPGWHT-01-0000-00GE5	XPGWHT-L1-0000-00GE5	XPGWHT-H1-0000-00GE5
		R3	122	XPGWHT-01-0000-00FE5	XPGWHT-L1-0000-00FE5	XPGWHT-H1-0000-00FE5
		R2	114	XPGWHT-01-0000-00EE5	XPGWHT-L1-0000-00EE5	XPGWHT-H1-0000-00EE5
		Q5	107		XPGWHT-L1-0000-00DE5	XPGWHT-H1-0000-00DE5
		Q4	100		XPGWHT-L1-0000-00CE5	

Notes

- Cree LED maintains a tolerance of ±7% on flux and power measurements, ±0.005 on chromaticity (CCx, CCy) measurements and a tolerance of ±2 on CRI measurements. See the Measurements section (page 21).
- XLamp XP-G LED order codes specify only a minimum flux bin and not a maximum. Cree LED may ship reels in flux bins higher than the minimum specified by the order code without advance notice. Shipments will always adhere to the chromaticity bin restrictions specified by the order code.

APPENDIX - ORDER CODES NOT FOR NEW DESIGNS - CONTINUED

Chromaticity		Minimum Luminous Flux (lm) @ 350 mA		Order Codes		
Kit	CCT	Code	Flux (lm)	70 CRI Minimum	75 CRI Typical	80 CRI Minimum
Z5	4000 K	R5	139		XPGWHT-L1-0000-00HZ5	XPGWHT-H1-0000-00HZ5
		R4	130		XPGWHT-L1-0000-00GZ5	XPGWHT-H1-0000-00GZ5
		R3	122		XPGWHT-L1-0000-00FZ5	XPGWHT-H1-0000-00FZ5
		R2	114		XPGWHT-L1-0000-00EZ5	XPGWHT-H1-0000-00EZ5
		Q5	107		XPGWHT-L1-0000-00DZ5	XPGWHT-H1-0000-00DZ5

Notes

- Cree LED maintains a tolerance of $\pm 7\%$ on flux and power measurements, ± 0.005 on chromaticity (CCx, CCy) measurements and a tolerance of ± 2 on CRI measurements. See the Measurements section (page 21).
- XLamp XP-G LED order codes specify only a minimum flux bin and not a maximum. Cree LED may ship reels in flux bins higher than the minimum specified by the order code without advance notice. Shipments will always adhere to the chromaticity bin restrictions specified by the order code.

APPENDIX - ORDER CODES NOT FOR NEW DESIGNS - CONTINUED

The following order codes are active and valid order codes, but higher performance options are also available. Please see page 5 - page 6 for order codes of XLamp XP-G LEDs that could serve as alternatives for the order codes set forth below.

Chromaticity		Minimum Luminous Flux (lm) @ 350 mA		Order Codes				
Kit	CCT	Code	Flux (lm)	70 CRI Typical	80 CRI Typical	80 CRI Minimum	85 CRI Minimum	90 CRI Minimum
F6	3750 K	S2	148	XPGWHT-01-0000-00JF6				
		R5	139	XPGWHT-01-0000-00HF6	XPGWHT-L1-0000-00HF6	XPGWHT-H1-0000-00HF6		
		R4	130	XPGWHT-01-0000-00GF6	XPGWHT-L1-0000-00GF6	XPGWHT-H1-0000-00GF6		
		R3	122	XPGWHT-01-0000-00FF6	XPGWHT-L1-0000-00FF6	XPGWHT-H1-0000-00FF6		
		R2	114	XPGWHT-01-0000-00EF6	XPGWHT-L1-0000-00EF6	XPGWHT-H1-0000-00EF6		
		Q5	107	XPGWHT-01-0000-00DF6	XPGWHT-L1-0000-00DF6	XPGWHT-H1-0000-00DF6		
		Q4	100		XPGWHT-L1-0000-00CF6	XPGWHT-H1-0000-00CF6		
E6	3500 K	S2	148	XPGWHT-01-0000-00JE6				
		R5	139	XPGWHT-01-0000-00HE6	XPGWHT-L1-0000-00HE6	XPGWHT-H1-0000-00HE6		
		R4	130	XPGWHT-01-0000-00GE6	XPGWHT-L1-0000-00GE6	XPGWHT-H1-0000-00GE6		
		R3	122	XPGWHT-01-0000-00FE6	XPGWHT-L1-0000-00FE6	XPGWHT-H1-0000-00FE6		
		R2	114	XPGWHT-01-0000-00EE6	XPGWHT-L1-0000-00EE6	XPGWHT-H1-0000-00EE6		
		Q5	107	XPGWHT-01-0000-00DE6	XPGWHT-L1-0000-00DE6	XPGWHT-H1-0000-00DE6		
		Q4	100		XPGWHT-L1-0000-00CE6	XPGWHT-H1-0000-00CE6		
Z6	3500 K	R5	139		XPGWHT-L1-0000-00HZ6	XPGWHT-H1-0000-00HZ6		
		R4	130		XPGWHT-L1-0000-00GZ6	XPGWHT-H1-0000-00GZ6		
		R3	122		XPGWHT-L1-0000-00FZ6	XPGWHT-H1-0000-00FZ6		
		R2	114		XPGWHT-L1-0000-00EZ6	XPGWHT-H1-0000-00EZ6		
		Q5	107		XPGWHT-L1-0000-00DZ6	XPGWHT-H1-0000-00DZ6		
		Q4	100		XPGWHT-L1-0000-00CZ6	XPGWHT-H1-0000-00CZ6		
F7	3250 K	S2	148					
		R5	139		XPGWHT-L1-0000-00HF7	XPGWHT-H1-0000-00HF7		
		R4	130		XPGWHT-L1-0000-00GF7	XPGWHT-H1-0000-00GF7		
		R3	122		XPGWHT-L1-0000-00FF7	XPGWHT-H1-0000-00FF7		
		R2	114		XPGWHT-L1-0000-00EF7	XPGWHT-H1-0000-00EF7		
		Q5	107		XPGWHT-L1-0000-00DF7	XPGWHT-H1-0000-00DF7		
		Q4	100		XPGWHT-L1-0000-00CF7	XPGWHT-H1-0000-00CF7		
		Q3	93.9		XPGWHT-L1-0000-00BF7	XPGWHT-H1-0000-00BF7		

Notes

- Cree LED maintains a tolerance of ±7% on flux and power measurements, ±0.005 on chromaticity (CCx, CCy) measurements and a tolerance of ±2 on CRI measurements. See the Measurements section (page 21).
- XLamp XP-G LED order codes specify only a minimum flux bin and not a maximum. Cree LED may ship reels in flux bins higher than the minimum specified by the order code without advance notice. Shipments will always adhere to the chromaticity bin restrictions specified by the order code.

APPENDIX - ORDER CODES NOT FOR NEW DESIGNS - CONTINUED

Chromaticity		Minimum Luminous Flux (lm) @ 350 mA		Order Codes				
Kit	CCT	Code	Flux (lm)	70 CRI Typical	80 CRI Typical	80 CRI Minimum	85 CRI Minimum	90 CRI Minimum
E7	3000 K	R4	130		XPGWHT-L1-0000-00GE7	XPGWHT-H1-0000-00GE7		
		R3	122		XPGWHT-L1-0000-00FE7	XPGWHT-H1-0000-00FE7		
		R2	114		XPGWHT-L1-0000-00EE7	XPGWHT-H1-0000-00EE7		
		Q5	107		XPGWHT-L1-0000-00DE7	XPGWHT-H1-0000-00DE7		
		Q4	100		XPGWHT-L1-0000-00CE7	XPGWHT-H1-0000-00CE7	XPGWHT-P1-0000-00CE7	XPGWHT-U1-0000-00CE7
		Q3	93.9		XPGWHT-L1-0000-00BE7	XPGWHT-H1-0000-00BE7	XPGWHT-P1-0000-00BE7	XPGWHT-U1-0000-00BE7
		Q2	87.4		XPGWHT-L1-0000-00AE7		XPGWHT-P1-0000-00AE7	XPGWHT-U1-0000-00AE7
		P4	80.6				XPGWHT-P1-0000-009E7	XPGWHT-U1-0000-009E7
		P3	73.9				XPGWHT-P1-0000-008E7	XPGWHT-U1-0000-008E7
Z7	3000 K	R4	130		XPGWHT-L1-0000-00GZ7	XPGWHT-H1-0000-00GZ7		
		R3	122		XPGWHT-L1-0000-00FZ7	XPGWHT-H1-0000-00FZ7		
		R2	114		XPGWHT-L1-0000-00EZ7	XPGWHT-H1-0000-00EZ7		
		Q5	107		XPGWHT-L1-0000-00DZ7	XPGWHT-H1-0000-00DZ7		
		Q4	100		XPGWHT-L1-0000-00CZ7	XPGWHT-H1-0000-00CZ7	XPGWHT-P1-0000-00CZ7	XPGWHT-U1-0000-00CZ7
		Q3	93.9		XPGWHT-L1-0000-00BZ7	XPGWHT-H1-0000-00BZ7	XPGWHT-P1-0000-00BZ7	XPGWHT-U1-0000-00BZ7
		Q2	87.4		XPGWHT-L1-0000-00AZ7		XPGWHT-P1-0000-00AZ7	XPGWHT-U1-0000-00AZ7
		P4	80.6				XPGWHT-P1-0000-009Z7	XPGWHT-U1-0000-009Z7
		P3	73.9				XPGWHT-P1-0000-008Z7	XPGWHT-U1-0000-008Z7
F8	2850 K	R4	130		XPGWHT-L1-0000-00GF8	XPGWHT-H1-0000-00GF8		
		R3	122		XPGWHT-L1-0000-00FF8	XPGWHT-H1-0000-00FF8		
		R2	114		XPGWHT-L1-0000-00EF8	XPGWHT-H1-0000-00EF8		
		Q5	107		XPGWHT-L1-0000-00DF8	XPGWHT-H1-0000-00DF8		
		Q4	100		XPGWHT-L1-0000-00CF8	XPGWHT-H1-0000-00CF8	XPGWHT-P1-0000-00CF8	XPGWHT-U1-0000-00CF8
		Q3	93.9		XPGWHT-L1-0000-00BF8	XPGWHT-H1-0000-00BF8	XPGWHT-P1-0000-00BF8	XPGWHT-U1-0000-00BF8
		Q2	87.4		XPGWHT-L1-0000-00AF8	XPGWHT-H1-0000-00AF8	XPGWHT-P1-0000-00AF8	XPGWHT-U1-0000-00AF8
		P4	80.6				XPGWHT-P1-0000-009F8	XPGWHT-U1-0000-009F8
		P3	73.9				XPGWHT-P1-0000-008F8	XPGWHT-U1-0000-008F8
P2	67.2				XPGWHT-P1-0000-007F8	XPGWHT-U1-0000-007F8		

Notes

- Cree LED maintains a tolerance of ±7% on flux and power measurements, ±0.005 on chromaticity (CCx, CCy) measurements and a tolerance of ±2 on CRI measurements. See the Measurements section (page 21).
- XLamp XP-G LED order codes specify only a minimum flux bin and not a maximum. Cree LED may ship reels in flux bins higher than the minimum specified by the order code without advance notice. Shipments will always adhere to the chromaticity bin restrictions specified by the order code.

APPENDIX - ORDER CODES NOT FOR NEW DESIGNS - CONTINUED

Chromaticity		Minimum Luminous Flux (lm) @ 350 mA		Order Codes				
Kit	CCT	Code	Flux (lm)	70 CRI Typical	80 CRI Typical	80 CRI Minimum	85 CRI Minimum	90 CRI Minimum
E8	2700 K	R4	130		XPGWHT-L1-0000-00GE8			
		R3	122		XPGWHT-L1-0000-00FE8	XPGWHT-H1-0000-00FE8		
		R2	114		XPGWHT-L1-0000-00EE8	XPGWHT-H1-0000-00EE8		
		Q5	107		XPGWHT-L1-0000-00DE8	XPGWHT-H1-0000-00DE8		
		Q4	100		XPGWHT-L1-0000-00CE8	XPGWHT-H1-0000-00CE8		
		Q3	93.9		XPGWHT-L1-0000-00BE8	XPGWHT-H1-0000-00BE8	XPGWHT-P1-0000-00BE8	XPGWHT-U1-0000-00BE8
		Q2	87.4		XPGWHT-L1-0000-00AE8	XPGWHT-H1-0000-00AE8	XPGWHT-P1-0000-00AE8	XPGWHT-U1-0000-00AE8
		P4	80.6				XPGWHT-P1-0000-009E8	XPGWHT-U1-0000-009E8
		P3	73.9				XPGWHT-P1-0000-008E8	XPGWHT-U1-0000-008E8
		P2	67.2				XPGWHT-P1-0000-007E8	XPGWHT-U1-0000-007E8
Z8	2700 K	R4	130		XPGWHT-L1-0000-00GZ8			
		R3	122		XPGWHT-L1-0000-00FZ8	XPGWHT-H1-0000-00FZ8		
		R2	114		XPGWHT-L1-0000-00EZ8	XPGWHT-H1-0000-00EZ8		
		Q5	107		XPGWHT-L1-0000-00DZ8	XPGWHT-H1-0000-00DZ8		
		Q4	100		XPGWHT-L1-0000-00CZ8	XPGWHT-H1-0000-00CZ8		
		Q3	93.9		XPGWHT-L1-0000-00BZ8	XPGWHT-H1-0000-00BZ8	XPGWHT-P1-0000-00BZ8	XPGWHT-U1-0000-00BZ8
		Q2	87.4		XPGWHT-L1-0000-00AZ8	XPGWHT-H1-0000-00AZ8	XPGWHT-P1-0000-00AZ8	XPGWHT-U1-0000-00AZ8
		P4	80.6				XPGWHT-P1-0000-009Z8	XPGWHT-U1-0000-009Z8
		P3	73.9				XPGWHT-P1-0000-008Z8	XPGWHT-U1-0000-008Z8
		P2	67.2				XPGWHT-P1-0000-007Z8	XPGWHT-U1-0000-007Z8

Notes

- Cree LED maintains a tolerance of ±7% on flux and power measurements, ±0.005 on chromaticity (CCx, CCy) measurements and a tolerance of ±2 on CRI measurements. See the Measurements section (page 21).
- XLamp XP-G LED order codes specify only a minimum flux bin and not a maximum. Cree LED may ship reels in flux bins higher than the minimum specified by the order code without advance notice. Shipments will always adhere to the chromaticity bin restrictions specified by the order code.