

SPECIFICATIONS

1. Features

REFERENCE

- 1-1 Scope of application : These specifications apply to the surface mount switch, LS71C4D1-T.
- 1-2 Shape and dimensions : As per the outline drawing.
- 1-3 Appearance : Any defects that affect performances are not allowed.
- 1-4 Temperature range for use : -30 ~ +85 °C (Switch must keep ON-OFF function.)
- 1-5 Temperature range for storage : -40 ~ +85 °C
- 1-6 Tests and measuring conditions :
Tests and measurements are performed under the standard conditions, unless specified otherwise.

Normal temperature : 20 ± 15 °C
 Normal humidity : 65 ± 20 %
 Normal pressure : 86 ~ 106 kPa

1-7 Parts code :

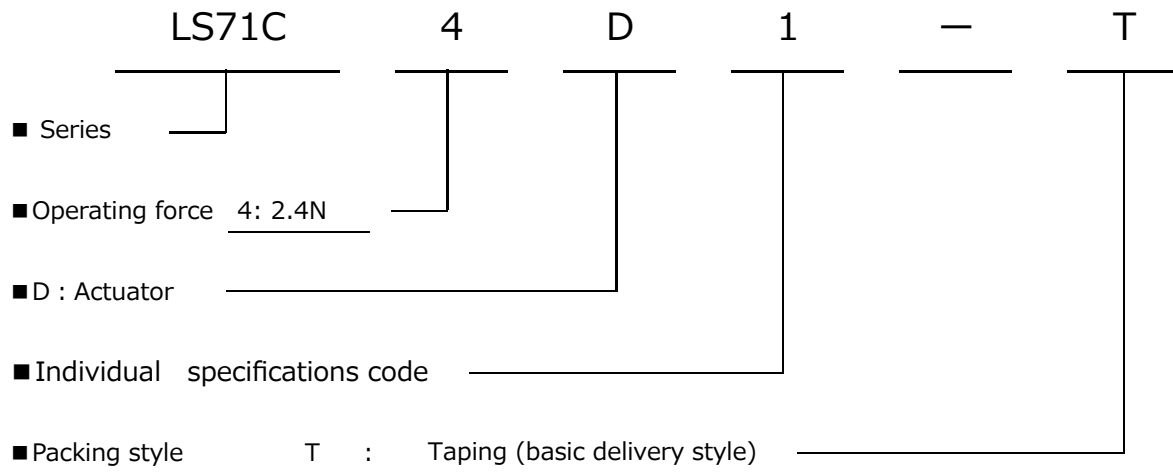

- 2. Rating Maximum rating DC 12 V , 20 mA
- Minimum rating DC 1 V , 10 μA

△					Product name	TACTILE SWITCH
△					Name	LS71C4D1
△					Drawing No.	
Mark	QTY	Date	Change	Name	Special note	

SPECIFICATIONS



3. Initial characteristics

REFERENCE

3-1 Mechanical characteristics

No.	Item	Performance	Measuring conditions
1	Operating force (F1)	<u>2.4</u> ± <u>0.7</u> N	Measure maximum operating force by vertically pressing the center of operating part gradually until it stops.
2	Stroke (S1)	<u>0.15</u> ± <u>0.07</u> mm	Measure stroke by vertically pressing the center of operating part until it stops.
3	Return force (F3)	<u>0.5</u> N or more	Measure return force after vertically pressing the center of the operating part until it does not move any more.

【Tip of the measuring head】

 ↓	Φ2.0, flat Metal (SUS)	 ↓	SR0.8 Metal (SUS)
For switch with plunger/actuator		For other switch	

3-2 Electrical characteristics

No.	Item	Performance	Measuring conditions
1	Contact resistance	<u>500</u> mΩ or less	Vertically apply static force, which is two times that of standard value, to the center of operating part and measure with 1kHz micro-current measuring instrument.
2	Insulation resistance	<u>100</u> MΩ or more	Apply DC 100V between the terminals for one minute, if the switch has a metal cover, apply it between the metal cover and the terminal for one minute.
3	Bounce	<u>20</u> ms or less	Press the center of operating part at the speed of 3 - 5 times per second lightly, and measure bounce at ON and OFF. Refer to the figure below.

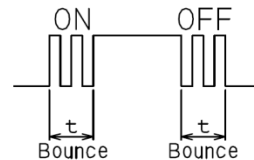
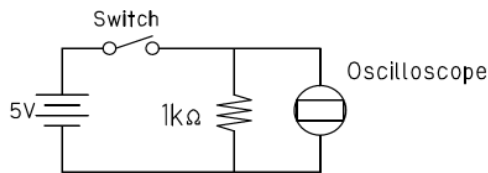

△					Product name	TACTILE SWITCH
△					Name	LS71C4D1
△					Drawing No.	
Mark	QTY	Date	Change	Name	Special note	

SPECIFICATIONS

3/9

4. Durability test

REFERENCE

4-1 Details of the tests

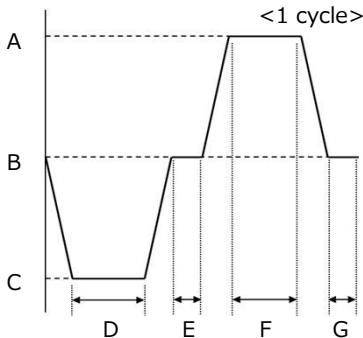
No.	Item	Test conditions
1	Operating life	1) DC <u>12</u> V , <u>5</u> mA resistance load 2) Test speed : <u>2</u> times/second 3) Test force : <u>3.1</u> N 4) Number of times of the test : <u>100</u> k times 5) Force load : Coil spring
2	Heat resistance	After exposure to the ambient condition of <u>85</u> ± <u>2</u> °C for <u>96</u> hours, expose test pieces for one hour in normal temperature and humidity and measure at standard condition.
3	Cold resistance	After exposure to the ambient condition of <u>-40</u> ± <u>2</u> °C for <u>96</u> hours, expose test pieces for one hour in normal temperature and humidity and measure at standard condition. Water droplets should be removed.
4	Humidity resistance	After exposure to the ambient condition of <u>60</u> ± <u>2</u> °C and relative humidity of <u>90~95</u> % for <u>96</u> hours, expose test pieces for one hour in normal temperature and humidity and measure at standard condition. Water droplets should be removed.
5	Temperature cycle	 <p>A = <u>90</u> °C B = <u>20</u> °C C = <u>-40</u> °C D = <u>0.5</u> h E = <u>0.25</u> h F = <u>0.5</u> h G = <u>0.25</u> h</p> <p>After applying the temperature cycle as per the diagram on the left <u>10</u> cycles, measure the test piece. Water droplet should be removed.</p>
6	Vibration resistance	Total amplitude of <u>1.5</u> mm. Vibration frequency of <u>10</u> to <u>55</u> Hz. In case of sweep, <u>10-55-10</u> Hz for approximately one minute. Vibrating directions: X, Y and Z. Test hours: <u>2</u> hours for each direction, total <u>6</u> hours.
7	Shock resistance	Shock acceleration <u>30</u> G. Shock directions X, Y and Z. Shock are applied <u>3</u> times for each 3 directions, total <u>9</u> times.
8	Stopper intensity	Apply static force of <u>30</u> N vertically to the center of operating part for <u>15</u> seconds.
9	Withstand voltage	Apply AC <u>250</u> V (50Hz or 60Hz) for <u>1</u> minute.

△					Product name	TACTILE SWITCH
△					Name	LS71C4D1
△					Drawing No.	
Mark	QTY	Date	Change	Name	Special note	

SPECIFICATIONS

4/9

REFERENCE

4-2 Failure judgment criteria

No.	Judgment item	Measurement condition	Failure judgment criteria
1	Operating force	Refer to 3-1. Measuring conditions	± 30 % or more of initial value.
2	Contact resistance	Refer to 3-2. Measuring conditions	10Ω or more
3	Insurance resistance	Refer to 3-2. Measuring conditions	$10 M\Omega$ or less
4	Bounce	Refer to 3-2. Measuring conditions	30 ms. or more when both ON and OFF.

5. Recommended soldering conditions

5-1 Reflow soldering

- (1) Temperatures of both pre-heating and main heating of the reflow furnace are to be set in accordance with the following temperature profile.
- (2) Maximum reflow number of times allowed: 2 times
2nd reflow should be conducted after the switch has cooled to normal temperature.
- (3) For improving solder wetness, it is recommended to plate the surface of PCB pattern with Au.
- (4) Recommended solder paste: S70G Type 5 from Senju Metal Industrial Co., Ltd. or similar.
If you use paste other than our recommendation, please verify it carefully before use.
- (5) Conditions can change for each reflow furnace, therefore sufficient verification prior to production is required.
- (6) As for PCB pattern and opening shape of the metal mask, refer to Page 7.
- (7) The standoff amount of SW after soldering should be controlled to be less than 50 μ m.

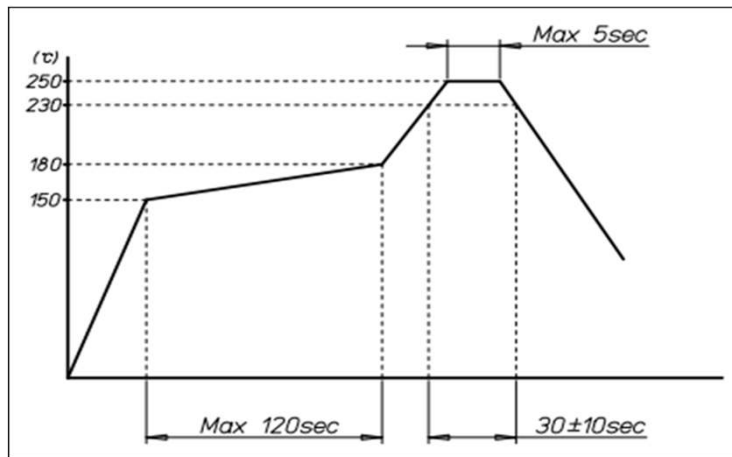

5-2 Manual soldering

- (1) Use a soldering iron of 20W or less and keep the temperature of the tip to less than 350°C, and use only one time for less than 3 seconds.
- (2) Pay attention to the soldering iron so that it does not touch product directly when handling.
- (3) After soldering, care must be taken not to handle the switch until its temperature cools and returns to normal temperature.

△					Product name	TACTILE SWITCH
△					Name	LS71C4D1
△					Drawing No.	
Mark	QTY	Date	Change	Name	Special note	

SPECIFICATIONS

7. Recommendation for design (Unit:mm)

REFERENCE

7-1. Recommended tip shape of the key cap

Design the key cap referring to the recommended shape in the right drawing.

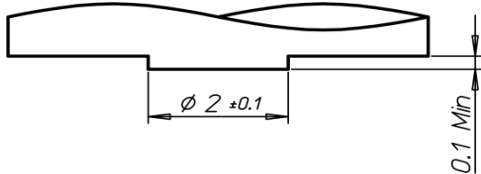

7-2. Recommended operating condition: Offset

Design the offset amount between the center of operating part and that of key cap as 0.4mm Max.

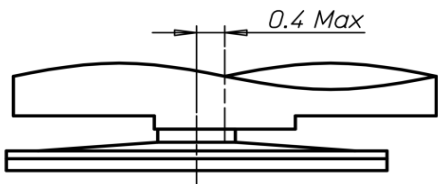

7-3. Recommended operating condition: Tilt

Design the tilt of key cap to be within $90 \pm 2^\circ$

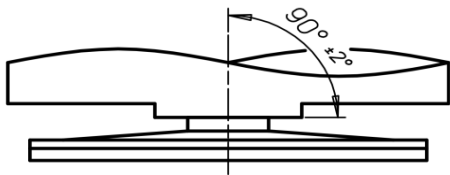

7-4. Recommended operating condition: Material

Select hard resin as the key cap material.
Soft material such as rubber is not recommended because it can impact on the characteristics.

Notes:

This section is for operation guarantee and not for characteristics guarantee (Section 3).

△					Product name	TACTILE SWITCH
△					Name	LS71C4D1
△					Drawing No.	
Mark	QTY	Date	Change	Name	Special note	

SPECIFICATIONS

8. Outline dimensional drawing

REFERENCE

Unit: mm

Tolerance: ±0.2

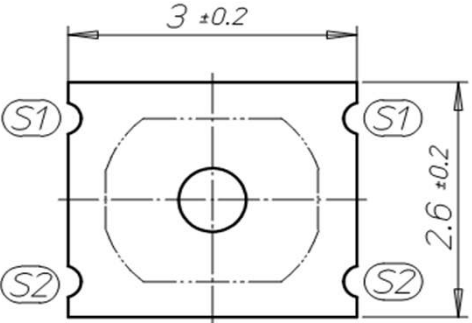

Top view

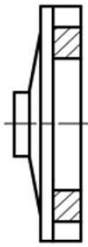

Side view

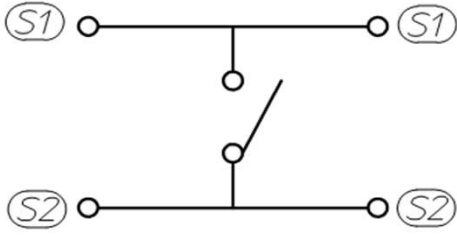

Circuit drawing

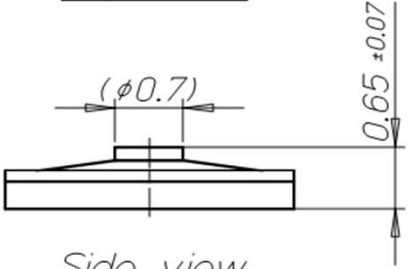

Side view

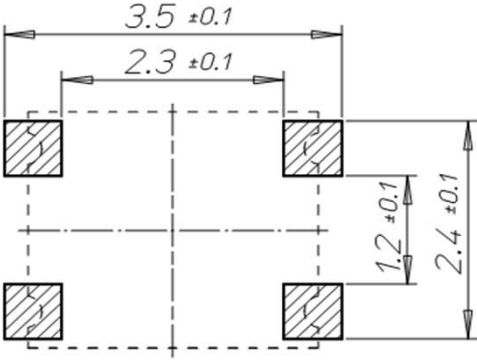

Recommendable soldering pattern

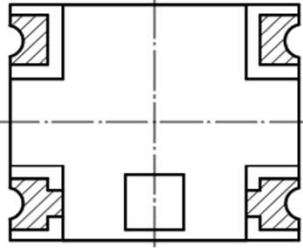

Bottom view

Notes:

- (1) Please design dimensions of metal mask for solder printing in the same dimensions as outline of soldering pattern.
0.1mm thickness of metal mask is recommended.
- (2) Please measure the height of the switch with a dial gauge. (Initial force: 30gf)

△					Product name	TACTILE SWITCH
△					Name	LS71C4D1
△					Drawing No.	
Mark	QTY	Date	Change	Name	Special note	

SPECIFICATIONS

9. Sectional plan

REFERENCE

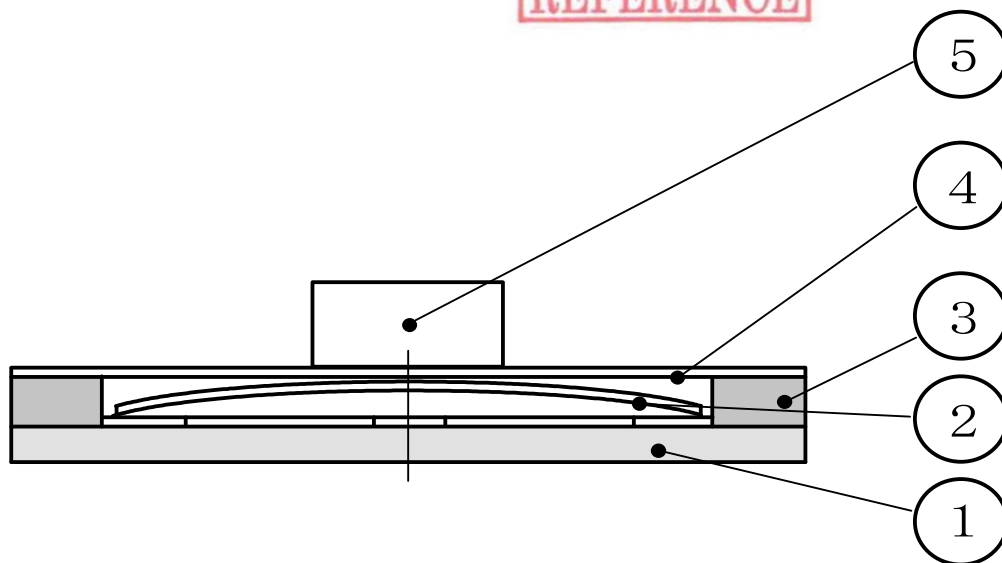

No.	Part name	Material	Remarks
1	Circuit board	FR-4	-
2	Spring	Stainless	-
3	Adhesive sheet	Polyimide	-
4	Waterproof sheet	Polyimide	-
5	Actuator	Polyimide	-

△					Product name	TACTILE SWITCH
△					Name	LS71C4D1
△					Drawing No.	
Mark	QTY	Date	Change	Name	Special note	

SPECIFICATIONS

9/9

10. Precautions

REFERENCE

- (1) This switch is not applicable for use in automobiles.
If you intend to use the switch for automobiles, please notify us before use for sure.
Do not use this switch in the equipment which requires high level safety and reliability, such as aviation apparatus, medical equipment etc.
- (2) If a short circuit is anticipated between the terminals due to high temperature high humidity, condensation or water droplets, please apply coating on the surface of solder.
- (3) Storage period of product
Before opening the moisture proof bag: Within 6 months after shipped from us and stored under normal temperature and humidity. After opening the bag, store products under normal temperature and normal humidity conditions and use them soon.
Store the switch in the place where the sunlight does not shine on and corrosive gas does not generate.
- (4) Do not use a switch so that stress is applied from the side to the plunger or actuator of the switch.
It can cause damage or peeling off.
- (5) Care must be taken to ensure that a force bigger than the specified value by the stopper intensity is not applied to the switch operating part. Physical stress should not be applied to the main body of switch other than the operating part.
- (6) Do not apply a shock to the switch.
If a shock is inevitable as a result of the structure used, it is recommended to build a stopper function and so on.
- (7) Warpage of the mounting PCB/FPC or PCB/FPC support can affect the performance and/or reliability of the switch. Pay attention to the impact of warpage when designing.
- (8) This switch was designed under the assumption that it would not remain pressed for a long time.
If you intend to use the switch in such a way, contact us before use.
- (9) If you intend to wash the switch with solvent after SMT soldering or manual soldering, contact us in advance.
- (10) When a switch is used for a set which requires critical safety, verify the influence brought by the failure of the switch itself in advance and secure the safety by preparing solutions such as a protective circuit, protective device or fail-safe design, etc.
- (11) Do not use the switch in the process or with the method under the environment that the switch is exposed to the pressure exceeding the range specified in item 1-6.
It can affect the characteristics or reliability of the switch.
- (12) If shipment is started three months after the specifications are issued, we regard the specifications as approved by customer, even if the specifications with his approval signature are not returned to us.

△					Product name	TACTILE SWITCH
△					Name	LS71C4D1
△					Drawing No.	
Mark	QTY	Date	Change	Name	Special note	