

REV.	DESCRIPTION	DATE
A	NEW DRAWING	12/19/2005

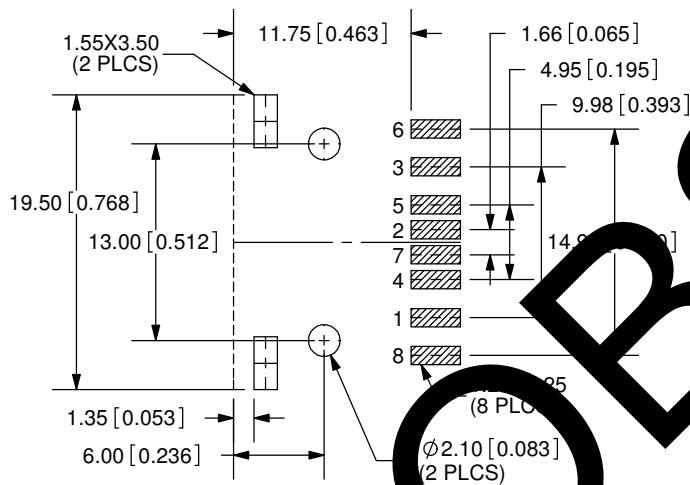
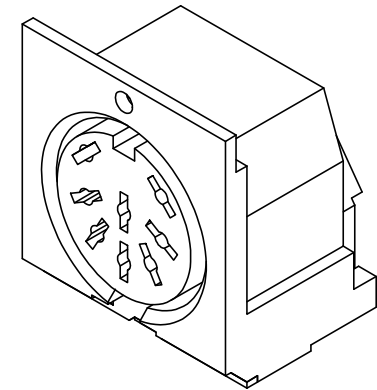
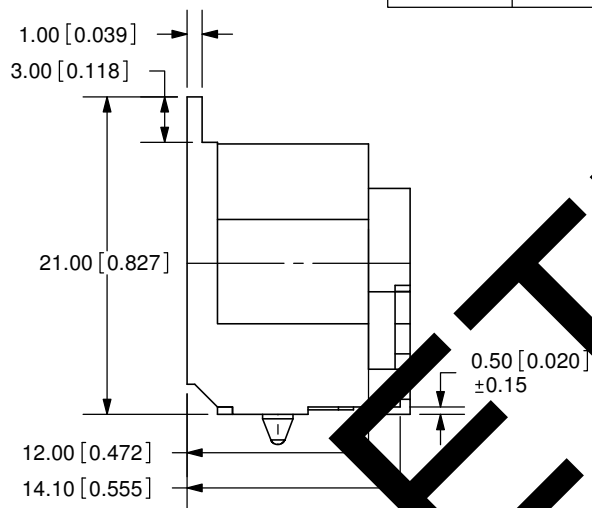
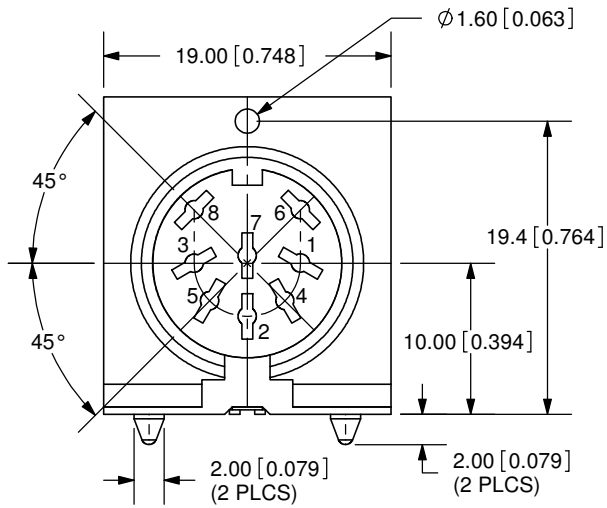

PCB LAYOUT  
TOP VIEW

**SPECIFICATIONS:**  
 RATING: 24V DC @ 1A; 100V AC @ 2A  
 CONTACT RESISTANCE: 30m OHMS MAX  
 INSULATION RESISTANCE: 100M OHMS MIN; 500V DC  
 VOLTAGE WITHSTAND: 500V AC R.M.S. FOR 1 MINUTE  
 LIFE: 5,000 CYCLES

TOLERANCE:  
 X.X ±0.2mm  
 X.XX ±0.1mm  
 X.XXX ±0.05mm



20050 SW 112th Ave.  
 Tualatin, OR 97062  
 Phone: 503-612-2300  
 800-275-4899  
 Fax: 503-612-2383  
 Website: www.cui.com

	MATERIAL	PLATING
TERMINALS (1-8)	Brass	Tin
EARTH TERMINAL	Phosphor Bronze	Tin
HOUSING	PBT	

TITLE: CIRCULAR DIN RECEPTACLE, SMT, 8 PIN	REV: A
PART NO. SDS-80J-SMT	UNITS: MM [INCHES]
DRAWN BY: ZRJ	APPROVED BY:
	SCALE: 2:1

PC FILE NAME:  
 SDS-80J-SMT

COPYRIGHT 2007 BY CUI INC.