

THIS DOCUMENT IS SUBJECT TO CHANGE WITHOUT NOTICE. IT IS CONFIDENTIAL AND A PROPERTY OF AMPHENOL LTW. DISCLOSURE TO THIRD PARTY HAS TO BE AUTHORIZED BY AMPHENOL LTW.

REV.	ECN NO.	DATE	SIGN	DESCRIPTION
A		2021/01/04	Wen	Rev.02 to Rev.A
B	C210409	2021/02/03	Wen	$\triangle B$ x4
C	C211405	2021/09/13	Wen	$\triangle C$ X2

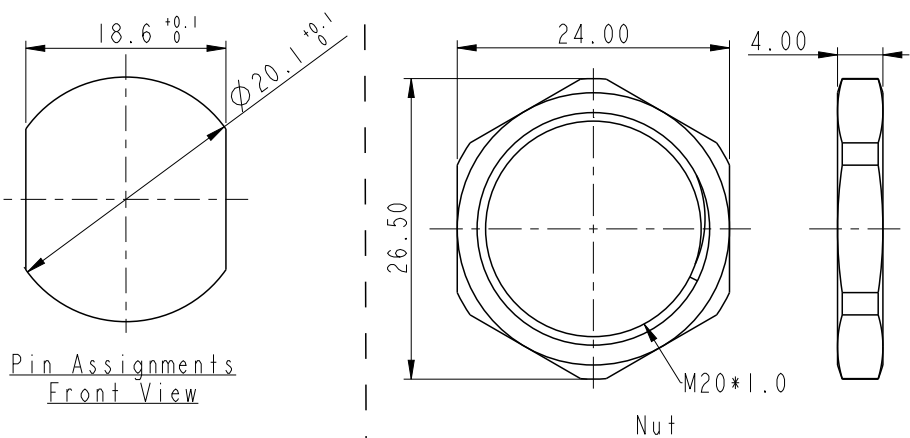
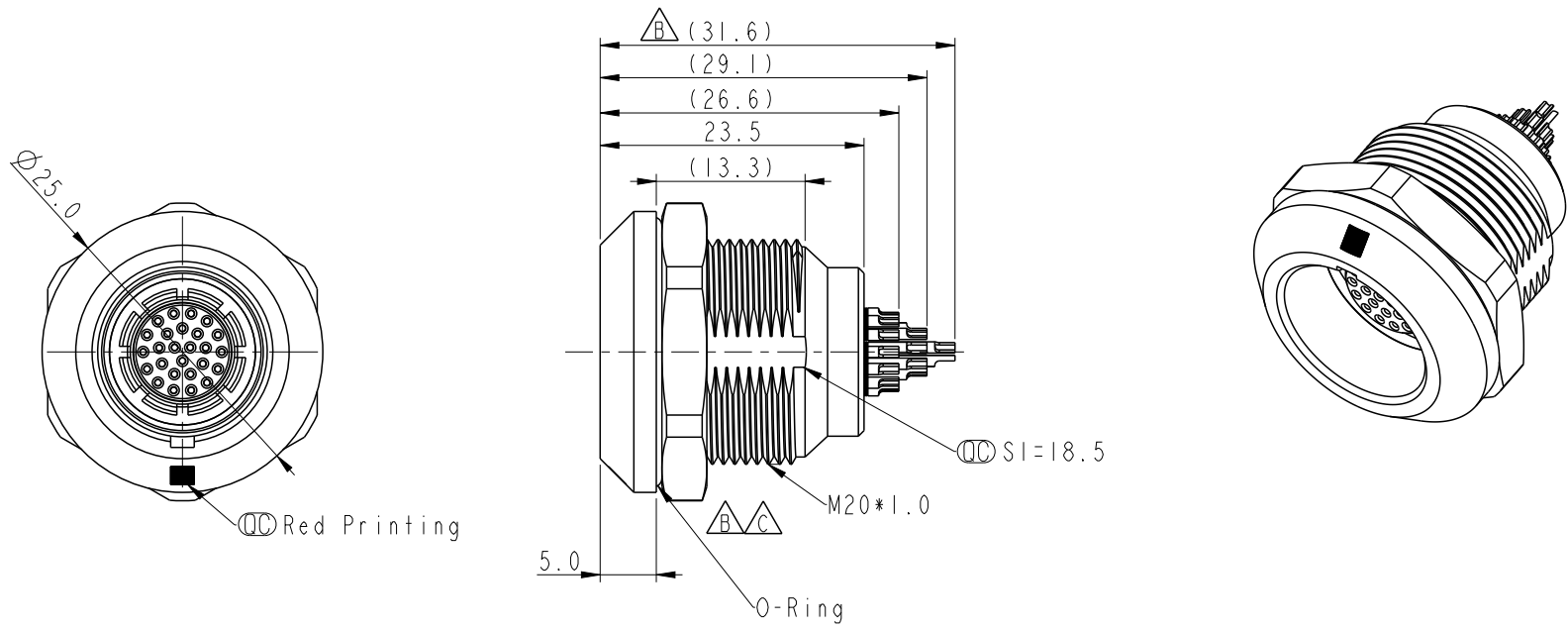

- Notes:
- * SI Important Dimensions To Check.
 - * $\triangle B$ Waterproof Rate: IPX8, Unmated 1m/24h
 - * Pin: Copper Alloy, Gold Plated.
 - * Housing: Thermoplastic, Black
 - * Shell: Metal
 - * Nut: Metal
 - * O-Ring: Rubber, Gray
 - * Use Panel Thickness Max: 8.0mm
 - * $\triangle C$ O-Ring and nut are assembled on connectors

UNIT:mm TOLERANCE $\pm 0.5\text{mm}$	TITLE FLO PLUS D SIZE,G CODE, PANEL CONNECTOR			ITEM NO		DRAWN BY Wen	DATE 2021/01/04
	SCALE 1:1	SIZE A4	SHEET 1 OF 2	DWG NO SLKD-XXEGFS-GCP-001	CHECKED BY Neo	DATE 2021/01/04	
	REV. C	WC-REV. .0	SI : Inspection item	CUSTOMER ALTW	APPROVED BY Max	DATE 2021/01/04	

Amphenol LTW
安費諾亮泰企業股份有限公司

THIS DOCUMENT IS SUBJECT TO CHANGE WITHOUT NOTICE. IT IS CONFIDENTIAL AND A PROPERTY OF Amphenol LTW. DISCLOSURE TO THIRD PARTY HAS TO BE AUTHORIZED BY Amphenol LTW.

1 2 3 4 5 6 7 8

F
E
D
C
B
A

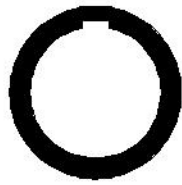
KEY POINT	
CODE	G
GRAPHIC	0° 

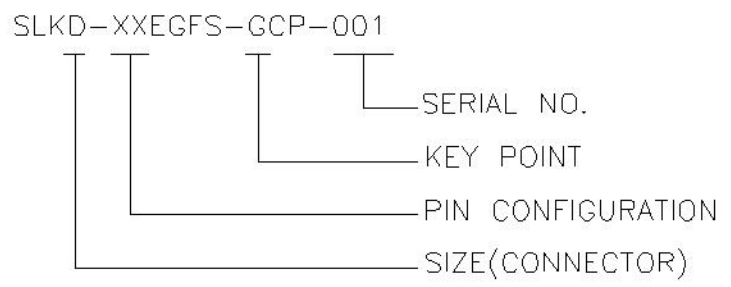

PIN CONFIGURATION (Solder Definition)

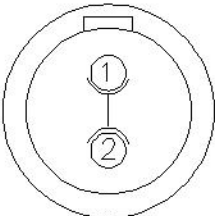
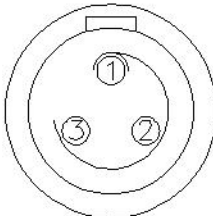
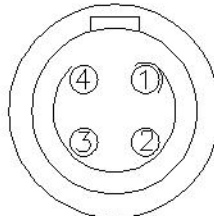
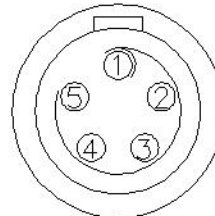
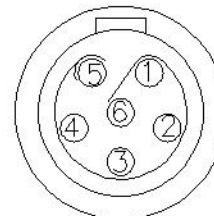
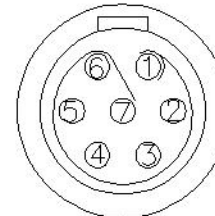
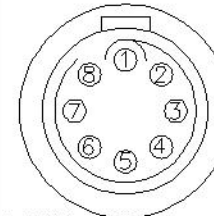
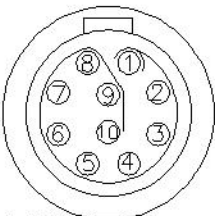
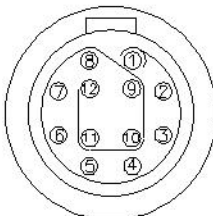
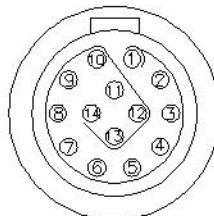
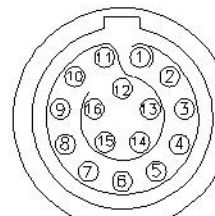
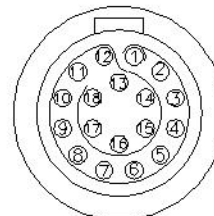
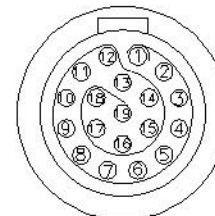
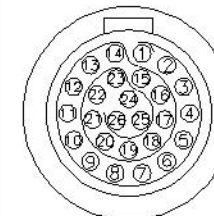
GRAPHIC	 2 PIN	 3 PIN	 4 PIN	 5 PIN	 6 PIN	 7 PIN	 8 PIN
	 10 PIN	 12 PIN	 14 PIN	 16 PIN	 18 PIN	 19 PIN	 26 PIN

UNIT:mm	
TOLERANCE	±0.5mm

TITLE FLO PLUS D SIZE,G CODE, PANEL CONNECTOR			
SCALE 1:1	SIZE A4	SHEET 2 OF 2	
REV. C	WC-REV. .0	☉: Inspection item	

Amphenol LTW
安費諾亮泰企業股份有限公司

ITEM NO	DRAWN BY Wen	DATE 2021/01/04
DWG NO SLKD-XXEGFS-GCP-001	CHECKED BY Neo	DATE 2021/01/04
CUSTOMER ALTW	APPROVED BY Max	DATE 2021/01/04

1 2 3 4 5 6 7 8 W10814-03-EM01A2