

PTRA084808NF

Thermally-Enhanced High Power RF LDMOS FET
550 W, 48 V, 734 – 821 MHz



Package Types: PG-HBSOF-6-2
PN: PTRA084808NF

Description

The PTRA084808NF is a 550-watt LDMOS FET intended for use in multi-standard cellular power amplifier applications in the 734 to 821 MHz frequency band. Features include input matching, high gain and thermally-enhanced package with earless flanges. Manufactured with Wolfspeed’s advanced LDMOS process, this device provides excellent thermal performance and superior reliability.

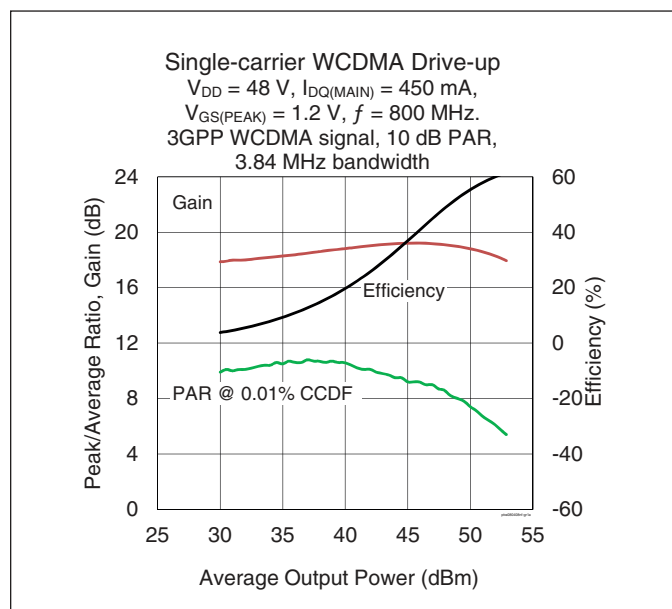

Features

- Broadband internal matching
- Asymmetric design
 - Main: $P_{1dB} = 200\text{ W}$ typical
 - Peak: $P_{1dB} = 350\text{ W}$ typical
- Typical pulsed CW performance (class AB), 800 MHz, 48 V, 10 μs pulse width, 10% duty cycle, Doherty configuration
 - Output power at $P_{3dB} = 550\text{ W}$
 - Efficiency = 56%
 - Gain = 18.5 dB
- Capable of handling 10:1 VSWR @ 48 V, 89 W (CW) output power
- Integrated ESD protection
- Human Body Model Class 1C (per ANSI/ESDA/ JEDEC JS-001)
- Low thermal resistance
- Pb-free and RoHS compliant

RF Characteristics

Single-carrier WCDMA Specifications (tested in Wolfspeed Doherty test fixture)

$V_{DD} = 48\text{ V}$, $I_{DQ} = 450\text{ mA}$, $V_{GS(PEAK)} = 1.2\text{ V}$, $P_{OUT} = 87\text{ W}$ avg, $f = 800\text{ MHz}$. 3GPP signal, channel bandwidth = 3.84 MHz, peak/average = 10 dB @ 0.01% CCDF.

Characteristic	Symbol	Min.	Typ.	Max.	Unit
Gain	G_{ps}	17.5	18.2	—	dB
Drain Efficiency	η_D	52.5	55	—	%
Adjacent Channel Power Ratio	ACPR	—	-30	-27.5	dBc
Output PAR @ 0.01% CCDF	OPAR	6.5	7	—	dB

Note:

All published data at $T_{CASE} = 25^\circ\text{C}$ unless otherwise indicated
 ESD: Electrostatic discharge sensitive device—observe handling precautions!





DC Characteristics (each side)

Characteristic	Symbol	Min.	Typ.	Max.	Unit	Conditions
Drain-Source Breakdown Voltage	$V_{BR(DSS)}$	105	—	—	V	$V_{GS} = 0\text{ V}, I_{DS} = 10\text{ mA}$
Drain Leakage Current	I_{DSS}	—	—	1	μA	$V_{DS} = 50\text{ V}, V_{GS} = 0\text{ V}$
		—	—	10		$V_{DS} = 105\text{ V}, V_{GS} = 0\text{ V}$
Gate Leakage Current	I_{GSS}	—	—	1		$V_{GS} = 10\text{ V}, V_{DS} = 0\text{ V}$
On-State Resistance (main)	$R_{DS(on)}$	—	0.08	—	Ω	$V_{GS} = 10\text{ V}, V_{DS} = 0.1\text{ V}$
On-State Resistance (peak)		—	0.05	—		
Operating Gate Voltage (main)	V_{GS}	3	3.5	4	V	$V_{DS} = 48\text{ V}, I_{DQ} = 0.45\text{ A}$
Operating Gate Voltage (peak)		—	2	—		$V_{DS} = 48\text{ V}, I_{DQ} = 0\text{ A}$

Maximum Ratings

Parameter	Symbol	Value	Unit
Drain-source Voltage	V_{DSS}	105	V
Gate-source Voltage	V_{GS}	-6 to +12	
Operating Voltage	V_{DD}	0 to +55	
Junction Temperature	T_J	225	$^{\circ}\text{C}$
Storage Temperature Range	T_{STG}	-65 to +150	

1. Operation above the maximum values listed here may cause permanent damage. Maximum ratings are absolute ratings; exceeding only one of these values may cause irreversible damage to the component. Exposure to absolute maximum rating conditions for extended periods may affect device reliability. For reliable continuous operation, the device should be operated within the operating voltage range (V_{DD}) specified above.

2. Parameters values can be affected by end application and product usage. Values may change over time.

Thermal Characteristics

Characteristics	Symbol	Value	Unit	Conditions
Thermal Resistance	$R_{\theta JC}$	0.51	$^{\circ}\text{C}/\text{W}$	$T_{CASE} = 70^{\circ}\text{C}, 87\text{ W (CW)}, 48\text{ V}, I_{DQ} = 450\text{ mA}, 800\text{ MHz}$

Moisture Sensitivity Level

Level	Test Signal	Package Temperature	Unit
3	IPC/JEDEC J-STD-020	260	$^{\circ}\text{C}$

Ordering Information

Type and Version	Order Code	Package and Description	Shipping
PTRA084808NF V1 R5	PTRA084808NF-V1-R5	PG-HBSOF-6-2, plastic overmold	Tape & Reel, 500 pcs



Typical Performance (data taken in Wolfspeed production test fixture)

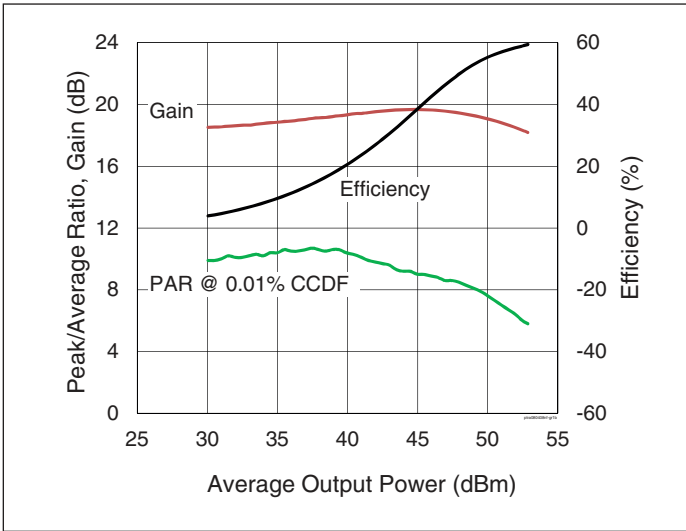

Figure 1. Single-carrier WCDMA Drive-up

$V_{DD} = 48\text{ V}$, $I_{DQ(MAIN)} = 450\text{ mA}$,
 $V_{GS(PEAK)} = 1.2\text{ V}$, $f = 770\text{ MHz}$.
 3GPP WCDMA signal, 10 dB PAR,
 3.84 MHz bandwidth

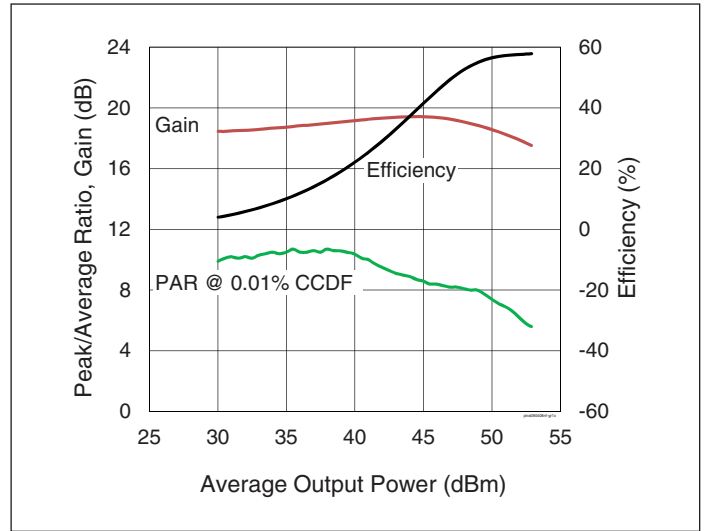

Figure 2. Single-carrier WCDMA Drive-up

$V_{DD} = 48\text{ V}$, $I_{DQ(MAIN)} = 450\text{ mA}$,
 $V_{GS(PEAK)} = 1.2\text{ V}$, $f = 740\text{ MHz}$.
 3GPP WCDMA signal, 10 dB PAR,
 3.84 MHz bandwidth

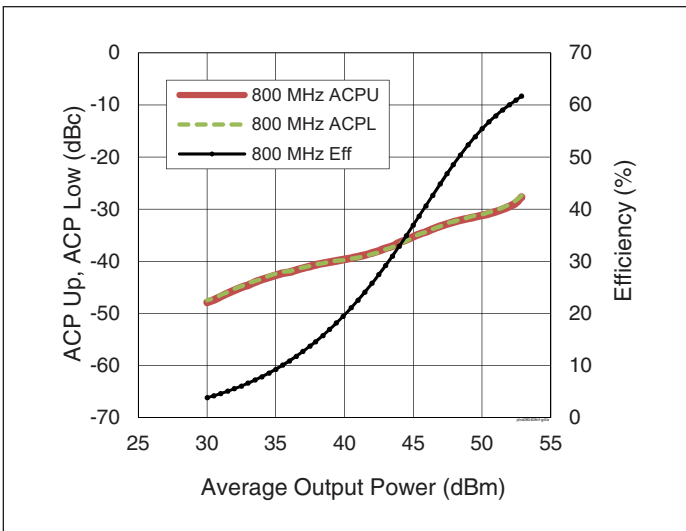

Figure 3. Single-carrier WCDMA Drive-up

$V_{DD} = 48\text{ V}$, $I_{DQ(MAIN)} = 450\text{ mA}$,
 $V_{GS(PEAK)} = 1.2\text{ V}$, $f = 800\text{ MHz}$,
 3GPP WCDMA signal, 10 dB PAR,
 3.84 MHz bandwidth

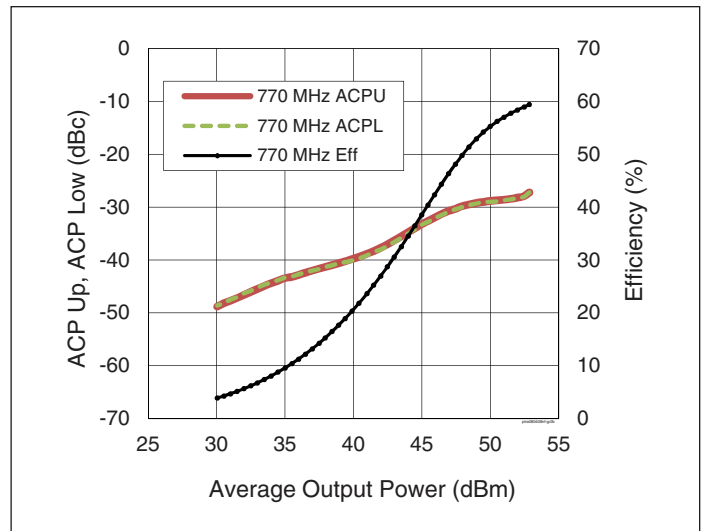

Figure 4. Single-carrier WCDMA Drive-up

$V_{DD} = 48\text{ V}$, $I_{DQ(MAIN)} = 450\text{ mA}$,
 $V_{GS(PEAK)} = 1.2\text{ V}$, $f = 770\text{ MHz}$.
 3GPP WCDMA signal, 10 dB PAR,
 3.84 MHz bandwidth



Typical Performance (cont.)

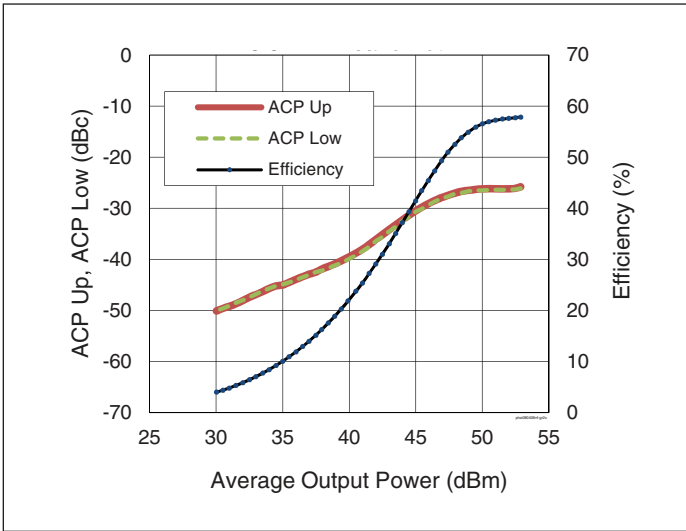

Figure 5. Single-carrier WCDMA Drive-up

$V_{DD} = 48\text{ V}$, $I_{DQ(MAIN)} = 450\text{ mA}$,
 $V_{GS(PEAK)} = 1.2\text{ V}$, $f = 740\text{ MHz}$.
 3GPP WCDMA signal, 10 dB PAR,
 3.84 MHz bandwidth

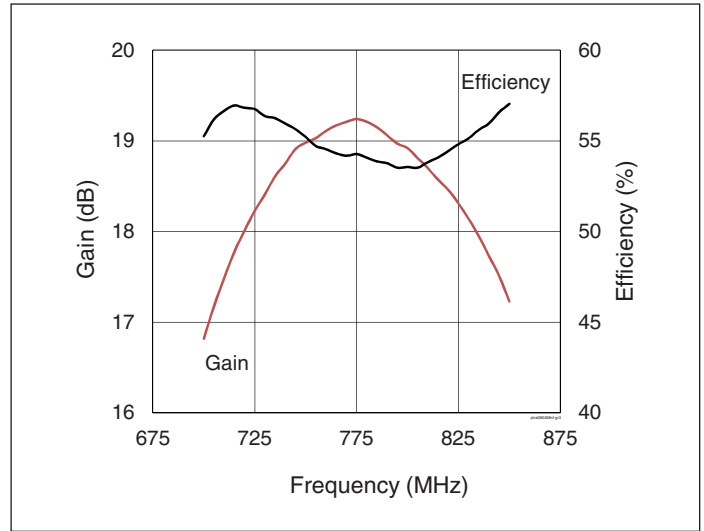

Figure 6. Single-carrier WCDMA Broadband

$V_{DD} = 48\text{ V}$, $I_{DQ(MAIN)} = 450\text{ mA}$,
 $V_{GS(PEAK)} = 1.2\text{ V}$, $P_{OUT} = 49.4\text{ dBm}$,
 3GPP WCDMA signal, 10 dB PAR

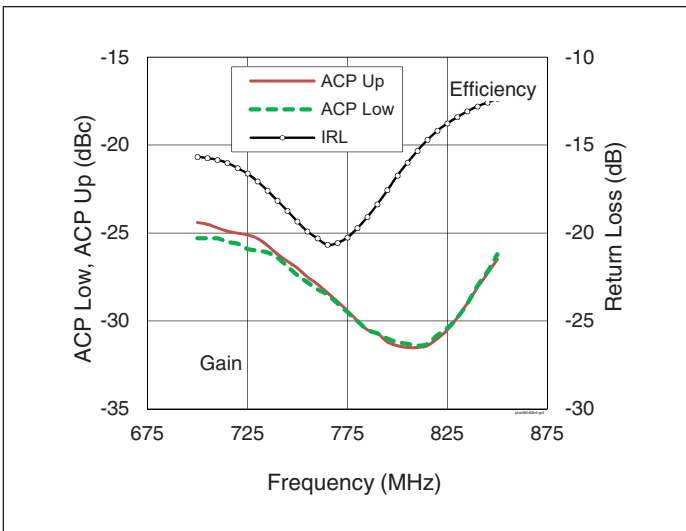

Figure 7. Single-carrier WCDMA Broadband

$V_{DD} = 48\text{ V}$, $I_{DQ(MAIN)} = 450\text{ mA}$,
 $V_{GS(PEAK)} = 1.2\text{ V}$, $P_{OUT} = 49.4\text{ dBm}$,
 3GPP WCDMA signal, 10 dB PAR

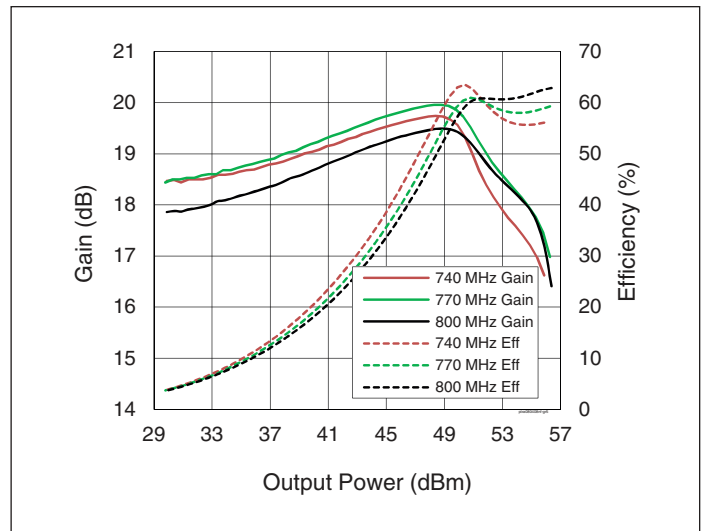

Figure 8. CW Performance

$V_{DD} = 48\text{ V}$, $I_{DQ(MAIN)} = 450\text{ mA}$,
 $V_{GS(PEAK)} = 1.2\text{ V}$



Typical Performance (cont.)

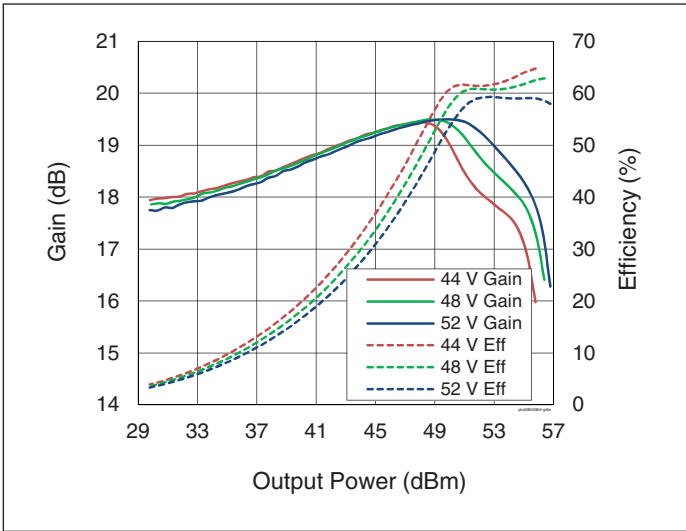

Figure 9. CW Performance at various V_{DD}

$I_{DQ(MAIN)} = 450 \text{ mA}$, $V_{GS(PEAK)} = 1.2 \text{ V}$,
 $f = 800 \text{ MHz}$

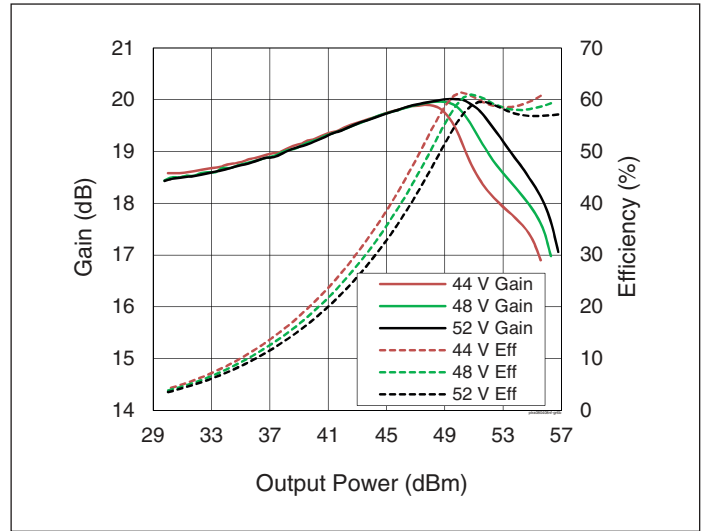

Figure 10. CW Performance at various V_{DD}

$I_{DQ(MAIN)} = 450 \text{ mA}$, $V_{GS(PEAK)} = 1.2 \text{ V}$,
 $f = 770 \text{ MHz}$

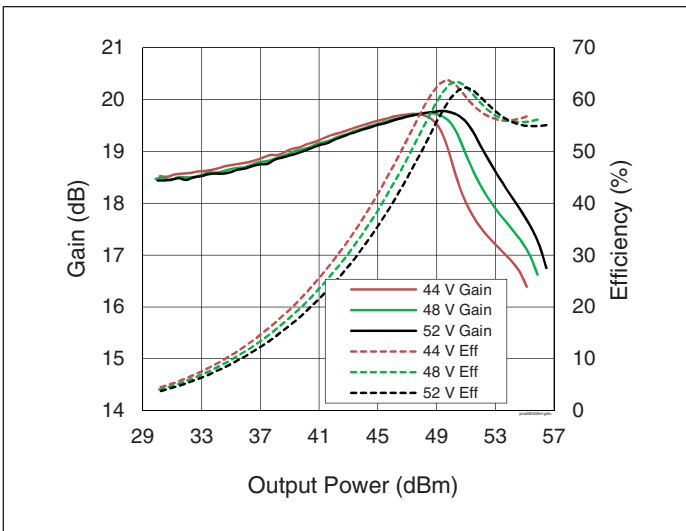

Figure 11. CW Performance at various V_{DD}

$I_{DQ(MAIN)} = 450 \text{ mA}$, $V_{GS(PEAK)} = 1.2 \text{ V}$,
 $f = 740 \text{ MHz}$

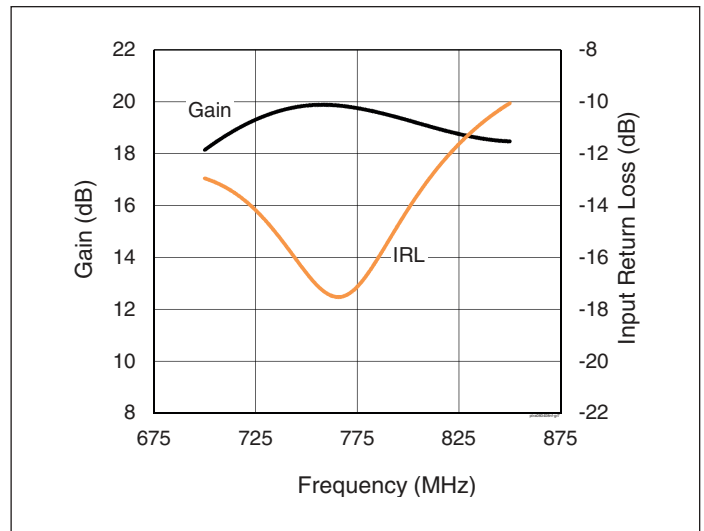

Figure 12. CW Performance Small Signal

$V_{DD} = 48 \text{ V}$, $I_{DQ(MAIN)} = 450 \text{ mA}$,
 $V_{GS(PEAK)} = 1.2 \text{ V}$



Load Pull Performance

Main side pulsed CW signal: 10 μ sec, 10% duty cycle, $V_{DD} = 48$ V, $I_{DQ} = 390$ mA, class AB

		P_{1dB}										
		Max Output Power					Max Drain Efficiency					
Freq [MHz]	Zs [Ω]	Zl [Ω]	Gain [dB]	P _{OUT} [dBm]	P _{OUT} [W]	η_D [%]	Zl [Ω]	Gain [dB]	P _{OUT} [dBm]	P _{OUT} [W]	η_D [%]	
730	2.00 – j3.64	1.96 – j0.96	20.5	53.53	225	56.4	4.71 + j0.66	22.1	51.59	144	66.1	
760	2.18 – j4.45	1.97 – j0.37	20.8	53.39	218	58.2	4.83 + j2.41	22.5	50.75	119	67.5	
780	2.23 – j4.48	1.75 – j0.81	20.5	53.18	208	52.8	4.95 + j1.41	22.9	51.00	126	66.9	
805	2.91 – j5.23	1.75 – j0.81	20.7	53.23	210	54.1	3.29 + j1.34	22.4	51.59	144	67.4	
820	2.96 – j5.44	1.96 – j0.96	21.2	53.12	205	55.8	3.43 + j0.83	22.7	51.79	151	67.6	

		P_{3dB}										
		Max Output Power					Max Drain Efficiency					
Freq [MHz]	Zs [Ω]	Zl [Ω]	Gain [dB]	P _{OUT} [dBm]	P _{OUT} [W]	η_D [%]	Zl [Ω]	Gain [dB]	P _{OUT} [dBm]	P _{OUT} [W]	η_D [%]	
730	2.00 – j3.64	1.96 – j0.96	18.5	54.48	281	60.9	5.35 + j1.53	20.2	51.79	151	67.9	
760	2.18 – j4.45	2.00 – j0.39	18.8	54.23	265	62.2	4.77 + j1.31	20.5	52.01	159	69.6	
780	2.23 – j4.48	1.56 – j1.27	18.2	54.11	258	53.7	4.29 + j1.74	20.6	51.82	152	69.3	
805	2.91 – j5.23	1.99 – j0.95	19.0	54.06	255	59.4	3.29 + j1.34	20.4	52.24	167	69.2	
820	2.96 – j5.44	1.99 – j1.26	19.2	53.99	251	58.1	3.60 + j1.21	20.8	52.16	164	69.8	

Peak side pulsed CW signal: 10 μ sec, 10% duty cycle, $V_{DD} = 48$ V, $V_{GSPK} = 2.2$ V, class C

		P_{1dB}										
		Max Output Power					Max Drain Efficiency					
Freq [MHz]	Zs [Ω]	Zl [Ω]	Gain [dB]	P _{OUT} [dBm]	P _{OUT} [W]	η_D [%]	Zl [Ω]	Gain [dB]	P _{OUT} [dBm]	P _{OUT} [W]	η_D [%]	
730	1.79 – j3.78	1.06 – j0.36	17.2	55.63	366	63.4	1.16 + j1.09	18.1	52.87	194	78.4	
760	2.22 – j4.57	1.05 – j0.36	17.2	55.58	361	64.3	0.87 + j0.93	18.2	52.54	179	77.8	
780	2.24 – j4.52	1.14 – j0.55	17.1	55.52	356	62.0	0.89 + j0.86	18.2	52.45	176	76.4	
805	2.57 – j5.09	1.33 – j0.81	17.0	55.28	337	61.2	1.30 + j0.58	18.0	53.22	210	74.0	
820	3.79 – j5.33	1.13 – j0.67	17.4	55.35	343	62.9	1.10 + j0.75	17.9	52.45	176	74.4	

		P_{3dB}										
		Max Output Power					Max Drain Efficiency					
Freq [MHz]	Zs [Ω]	Zl [Ω]	Gain [dB]	P _{OUT} [dBm]	P _{OUT} [W]	η_D [%]	Zl [Ω]	Gain [dB]	P _{OUT} [dBm]	P _{OUT} [W]	η_D [%]	
730	1.79 – j3.78	1.06 – j0.36	15.2	56.36	433	65.0	1.12 + j0.79	16.2	54.27	267	77.7	
760	2.22 – j4.57	1.33 – j0.44	15.3	56.34	431	68.4	1.42 + j0.90	15.9	54.04	254	76.2	
780	2.24 – j4.52	1.16 – j0.62	15.0	56.36	433	64.0	1.31 + j0.54	16.0	54.53	284	75.9	
805	2.57 – j5.09	1.34 – j0.81	15.0	56.09	406	63.3	1.39 + j0.47	15.9	54.28	268	74.0	
820	3.79 – j5.33	1.21 – j0.71	15.3	56.08	406	64.4	1.25 + j0.46	16.0	54.14	259	74.1	



Evaluation Board, 734 to 821 MHz

Evaluation Board Part Number	LTA/PTRA084808NF-V1
PCB Information	Rogers 4360, 0.609 mm [0.024"] thick, 2 oz. copper, $\epsilon_r = 6.15$

Find Gerber files for this test fixture on the Wolfspeed Web site at www.wolfspeed.com/RF

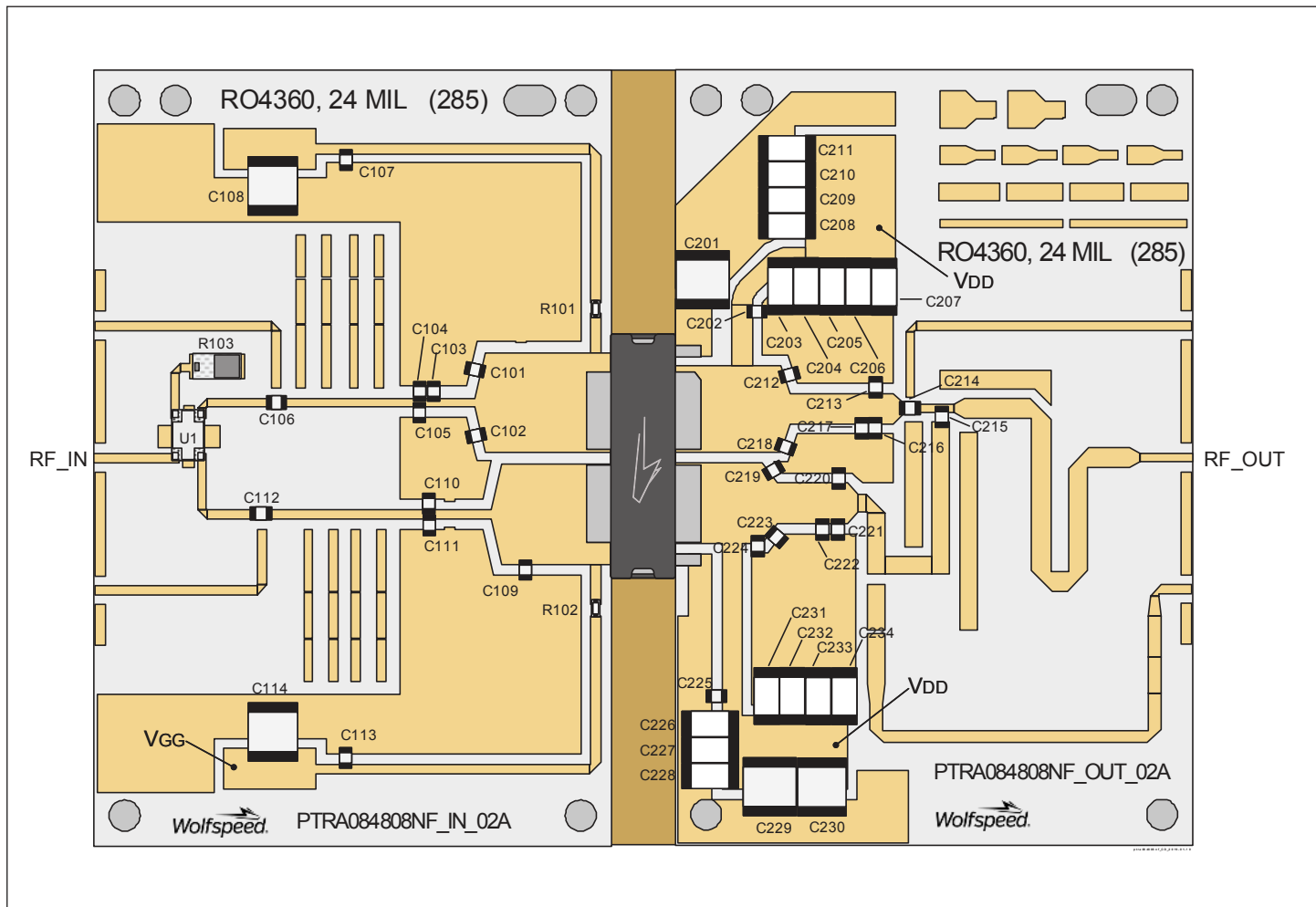

Reference circuit assembly diagram (not to scale)



Components Information

Component	Description	Manufacturer	P/N
Input			
C101, C102	Capacitor, 2.7 pF	ATC	ATC600F2R7CT250
C103	Capacitor, 1.4 pF	ATC	ATC600F1R4CT250
C104	Capacitor, 3.9 pF	ATC	ATC600F3R9CT250
C105	Capacitor, 1.0 pF	ATC	ATC600F1R0CT250
C106	Capacitor, 68 pF	ATC	ATC600F680JT250
C107, C113	Capacitor, 82 pF	ATC	ATC600F820JT250
C108, C114	Capacitor, 10 μ F, 100V	TDK Corporation	C5750X7S2A106M230KB
C109	Capacitor, 5.6 pF	ATC	ATC600F5R6CT250
C110	Capacitor, 4.7 pF	ATC	ATC600F4R7CT250
C111	Capacitor, 2.0 pF	ATC	ATC600F2R0CT250
C112	Capacitor, 56 pF	ATC	ATC800A560JT250
R101, R102	Resistor, 10 ohms	Panasonic Electronic Components	ERJ-8GEYJ100V
R103	Resistor, 50 ohms	Anaren	C8A50Z4A
U1	Hybrid coupler	Anaren	X3C07F1-02S
Output			
C201, C203, C204, C205, C206, C207, C208, C209, C210, C211, C226, C227, C228, C229, C230, C231, C232, C233, C234	Capacitor, 10 μ F, 100V	TDK Corporation	C5750X7S2A106M230KB
C202, C215	Capacitor, 82 pF	ATC	ATC600F820JT250
C212	Capacitor, 10 pF	ATC	ATC600F100JT250
C213	Capacitor, 6.8 pF	ATC	ATC600F6R8CT250
C214	Capacitor, 47 pF	ATC	ATC600F470JT250
C216, C222	Capacitor, 1.0 pF	ATC	ATC600F1R0CT250
C217	Capacitor, 3.9 pF	ATC	ATC600F3R9CT250
C218	Capacitor, 5.6 pF	ATC	ATC600F5R6CT250
C219, C223	Capacitor, 12 pF	ATC	ATC600F120JT250
C220, C221	Capacitor, 1.5 pF	ATC	ATC600F1R5CT250
C224	Capacitor, 2.0 pF	ATC	ATC600F2R0CT250
C225	Capacitor, 100 pF	ATC	ATC600F101JT250



Pinout Diagram (top view)

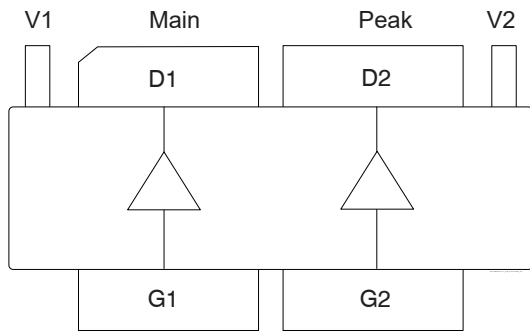

Pin	Description
D1	Drain Device 1 (Main)
D2	Drain Device 2 (Peak)
G1	Gate Device 1 (Main)
G2	Gate Device 2 (Peak)
S	Source (flange)
V1	Drain video decoupling, no DC bias
V2	NC (not connected to ground)

See next page for package mechanical specifications.



Package Outline Specifications – Package PG-HBSOF-6-2 (top and side views)

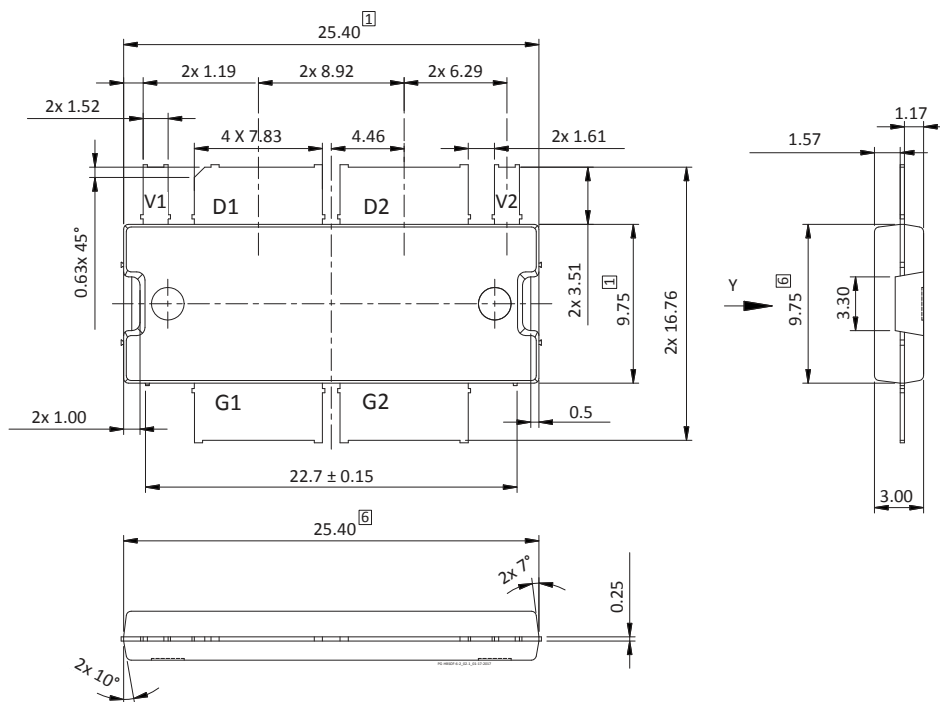

Diagram Notes—unless otherwise specified:

- 1. Mold/dam bar/metal protrusion of 0.30 mm max per side not included.
- 2. Metal protrusions are connected to source and shall not exceed 0.10 mm max.
- 3. Fillets and radii: all radii are 0.3 mm max.
- 4. Interpret dimensions and tolerances per ISO 8015.
- 5. Dimensions are mm.
- 6. Does not include mold/dam bar and metal protrusion.
- 7. Exposed metal surface is tin-plated, may not be covered by mold compound.
- 8. All tolerances ± 0.1 mm unless specified otherwise.
- 9. All metal surfaces are tin-plated, except area of cut.
- 10. Lead thickness: 0.25 mm.
- 11. Pins: D1, D2 = drain; G1, G2 = gate; S = source, V1, V2 = no DC bias, NC or connect to GRD

Package Outline Specifications (cont.) – Package PG-HBSOF-6-2 (bottom view)

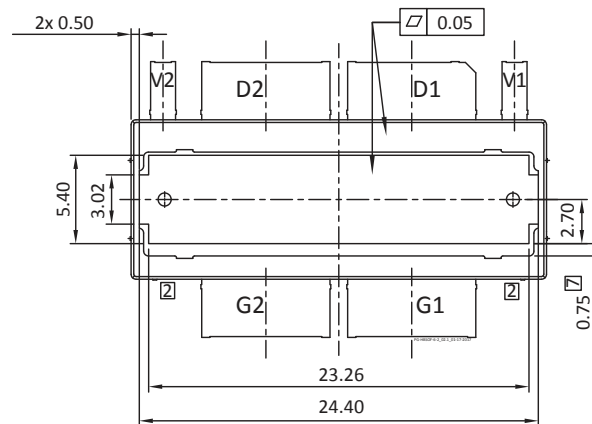

Diagram Notes—unless otherwise specified:

1. Mold/dam bar/metal protrusion of 0.30 mm max per side not included.
2. Metal protrusions are connected to source and shall not exceed 0.10 mm max.
3. Fillets and radii: all radii are 0.3 mm max.
4. Interpret dimensions and tolerances per ISO 8015.
5. Dimensions are mm.
6. Does not include mold/dam bar and metal protrusion.
7. Exposed metal surface is tin-plated, may not be covered by mold compound.
8. All tolerances ± 0.1 mm unless specified otherwise.
9. All metal surfaces are tin-plated, except area of cut.
10. Lead thickness: 0.25 mm.
11. Pins: D1, D2 = drain; G1, G2 = gate; S = source, V1, V2 = no DC bias, NC or connect to GRD

**For more information, please contact:**

4600 Silicon Drive
Durham, NC 27703 USA
Tel: +1.919.313.5300
www.wolfspeed.com/RF

Sales Contact
RFSales@wolfspeed.com

RF Product Marketing Contact
RFMarketing@wolfspeed.com

Notes & Disclaimer

Specifications are subject to change without notice. “Typical” parameters are the average values expected by Wolfspeed in large quantities and are provided for information purposes only. Wolfspeed products are not warranted or authorized for use as critical components in medical, life-saving, or life-sustaining applications, or other applications where a failure would reasonably be expected to cause severe personal injury or death. No responsibility is assumed by Wolfspeed for any infringement of patents or other rights of third parties which may result from use of the information contained herein. No license is granted by implication or otherwise under any patent or patent rights of Wolfspeed.

© 2022 Wolfspeed, Inc. All rights reserved. Wolfspeed® and the Wolfstreak logo are registered trademarks and the Wolfspeed logo is a trademark of Wolfspeed, Inc.
PATENT: <https://www.wolfspeed.com/legal/patents>

The information in this document is subject to change without notice.