



Datasheet

Part No:

G24.A.305111

Description:

G24 Ultima Series – Super Low Profile
Penta Band Cellular Antenna Permanent mount
GSM/GPRS/CDMA/HSPA

Features:

Height 20mm(0.77”) and diameter 55mm(2.16”)
Heavy duty screw mount
UV and vandal resistant PC housing and thread
IP67 compliant
Standard is 3 meter low loss cable TGC-200 SMA(M)
Cables and Connectors Customizable

✓ **RoHS**

✓ **REACH**
COMPLIANT

1. Introduction	3
2. Specifications	4
3. Antenna Characteristics	5
4. 2D Radiation Patterns	8
5. Installation	16
6. Mechanical Drawing	17
7. Packaging	18

Taoglas makes no warranties based on the accuracy or completeness of the contents of this document and reserves the right to make changes to specifications and product descriptions at any time without notice. Taoglas reserves all rights to this document and the information contained herein.

Reproduction, use or disclosure to third parties without express permission is strictly prohibited.

Copyright © Taoglas Ltd.



1. Introduction



G24 Ultima Series Cellular Antenna is an extremely low profile 2G/3G 800MHz to 2200MHz cellular antenna solution for professional telematics applications. Suitable for GSM/GPRS/CDMA applications worldwide, at only 20mm (0.77") in height it is the lowest profile antenna in the market, with a diameter of only 55 mm (2.16"). It works well when mounted on both metal and non-metal. In other words, it does not need a metal ground-plane to attach to, to radiate, something that competitor antennas all need. Taoglas recommend a minimum cable length of 70mm when used on a ground plane to achieve an efficiency of greater than 20%.

Durable UV PC housing, thread and nut is resistant to vandalism and direct attack.

The IP67 waterproof robust plastic body makes it extremely light, economical for shipping and minimum weight impact on vehicles. This also makes it ideal for use in humid environments such as water pits or marine applications as there are no metal parts to corrode. The closed cell foam with double-sided adhesive provides a permanent waterproof seal and can adjust to different curvatures, stopping water from leaking under the antenna into the mounting hole. Lowest loss PTFE cable is used for maximum gain and reduced noise entry through the cable.

The G24 is also available in white.

2. Specifications

Cellular					
Frequency (MHz)	824~896	880~960	1710~1880	1850~1990	1920~2170
Peak Gain (dBi)					
Free space	2.0	1.8	3.9	3.9	3.9
10*10cm ground plane	-0.6	0.7	-0.2	1.7	1.7
20*20cm ground plane	1.8	1.8	3.1	3.1	3.1
30*30cm ground plane	0.0	0.0	1.7	1.7	2.0
Average Gain (dBi)					
Free space	-4.1	-4.0	-2.7	-2.8	-2.7
10*10cm ground plane	-4.8	-3.3	-4.9	-4.0	-4.0
20*20cm ground plane	-4.3	-4.3	-4.2	-4.0	-4.0
30*30cm ground plane	-6.3	-6.6	-4.4	-4.4	-4.4
Efficiency (%)					
Free space	39.1	39.3	53.4	52.5	53.4
10*10cm ground plane	33.8	46.2	32.1	40.0	40.0
20*20cm ground plane	36.9	36.9	37.8	39.3	39.3
30*30cm ground plane	23.4	23.4	36.0	36.0	36.0
Impedance	50Ω				
Polarization	Linear				
Radiation Pattern	Omni				
Input Power	10 W				
Mechanical					
Dimensions	Ø55±2mm , Height 30±2 mm, Profile 19.6mm				
Cable type	TGC-200				
Connector	SMA Male Straight				
Cable length	3000mm				
Casing	PC				

Environmental	
Temperature Range	-40°C to 85°C
Waterproof	IP-67
Thermal Shock	100 cycles -40°C to +80°C
Shock (drop test)	1m drop on concrete 6 axes
Humidity	Non-condensing 65°C 95% RH
Weight	180g
Recommended Torque for	3.92N·m
Max Torque for Mounting	4.9N·m

3. Antenna Characteristics

3.1 Cellular antenna SWR

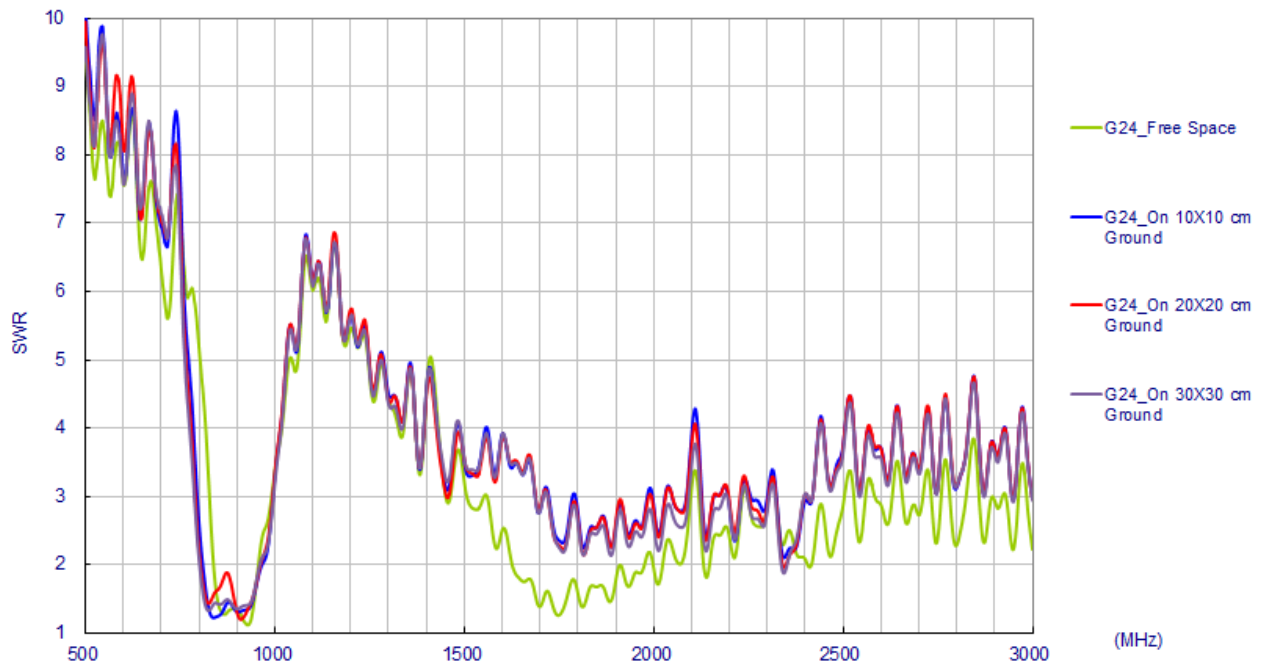

3.2 Efficiency

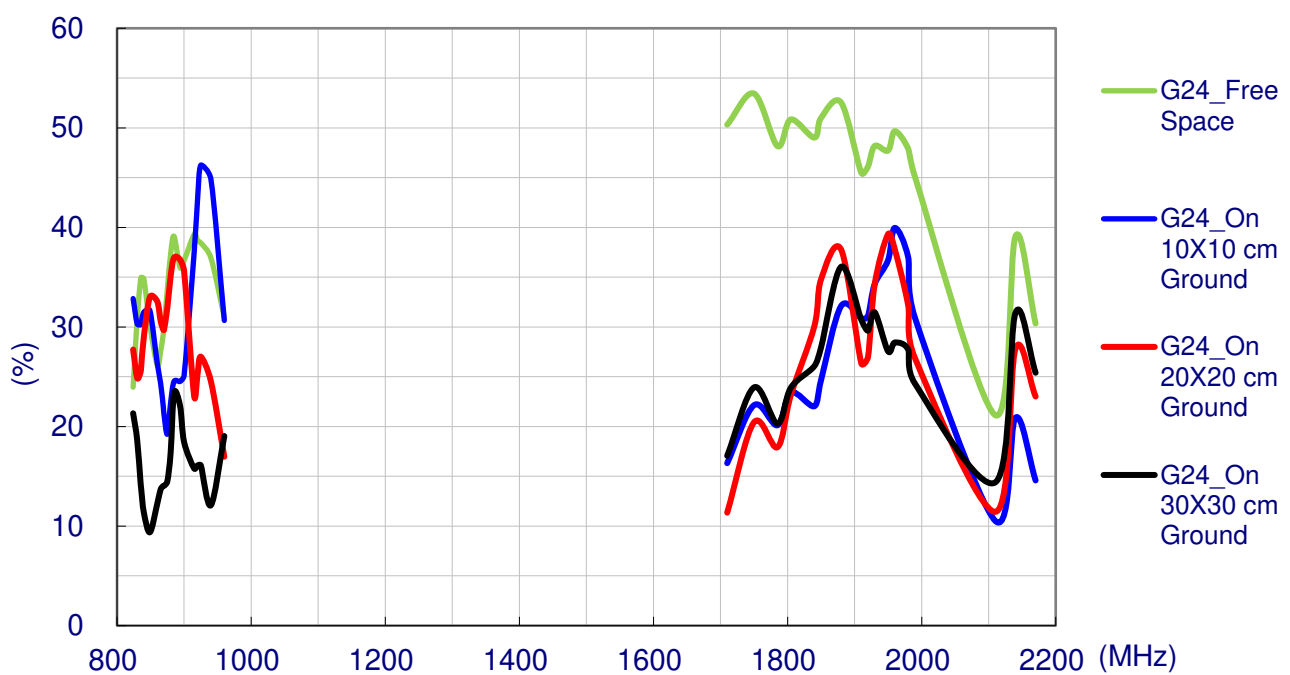

3.3 Average Gain

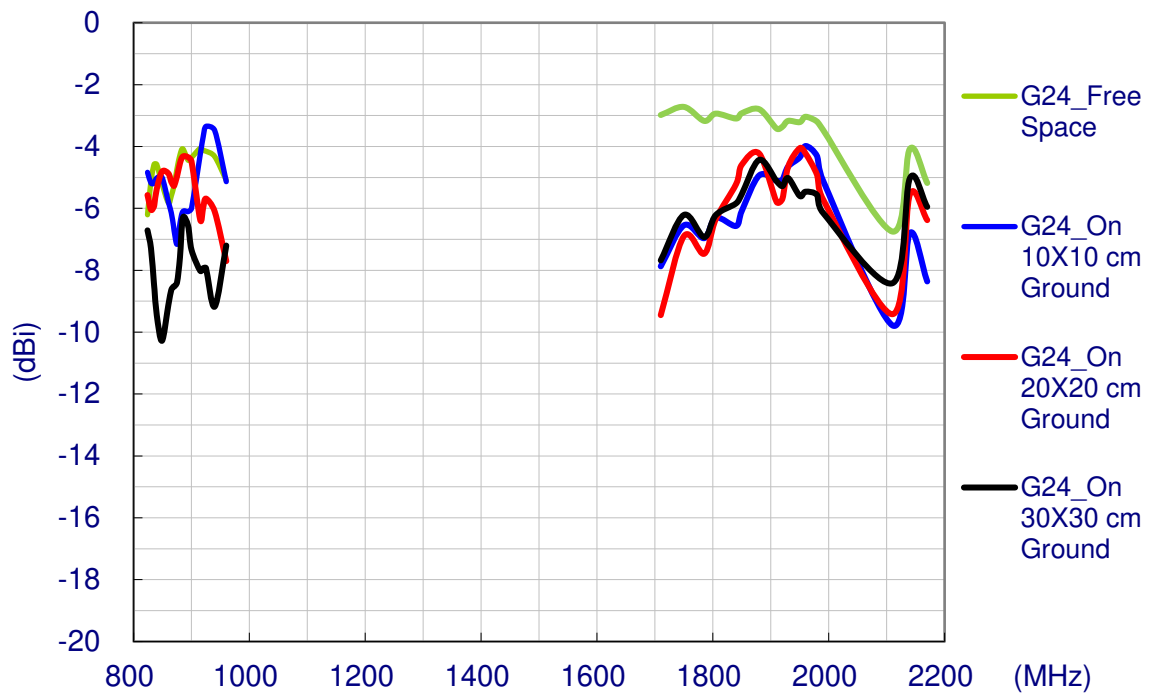

3.4 Peak Gain

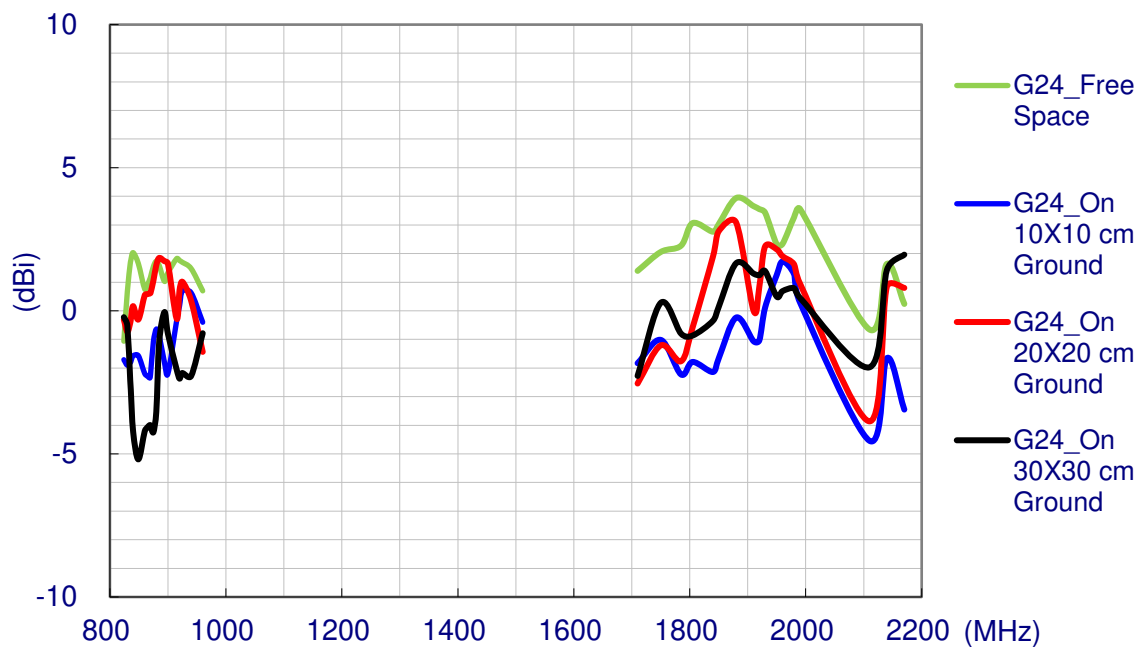

4. 2D Radiation Patterns

4.1 Test Setup



Free space

XY Plane

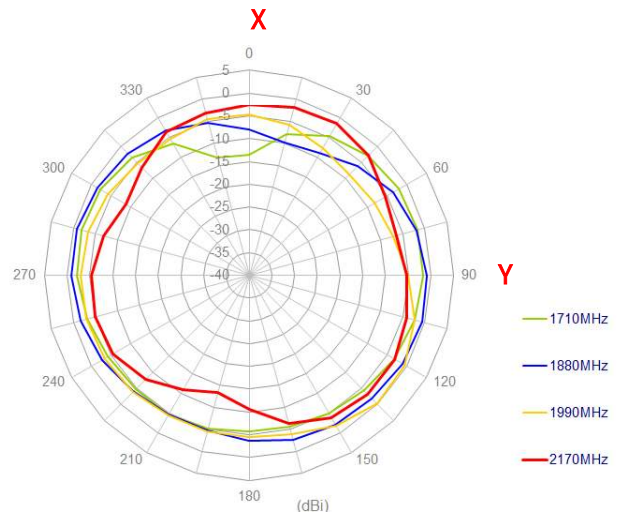
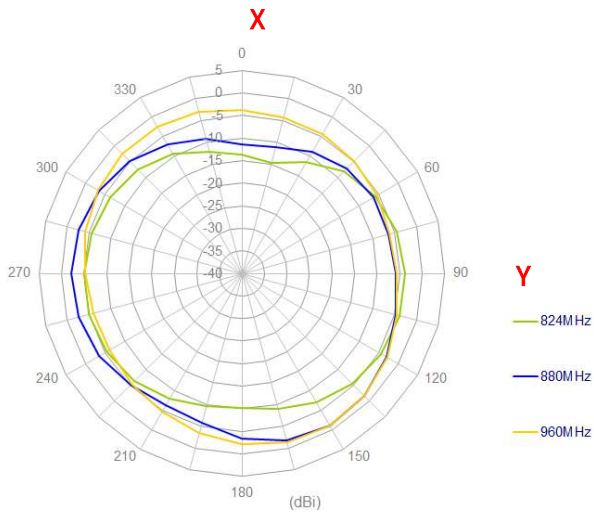

XZ Plane

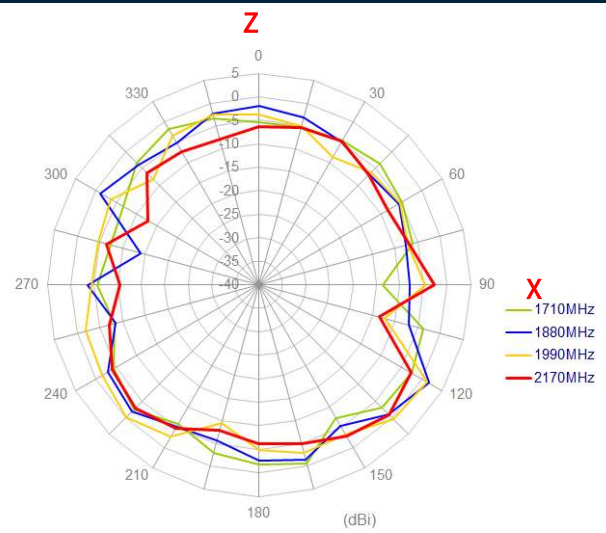
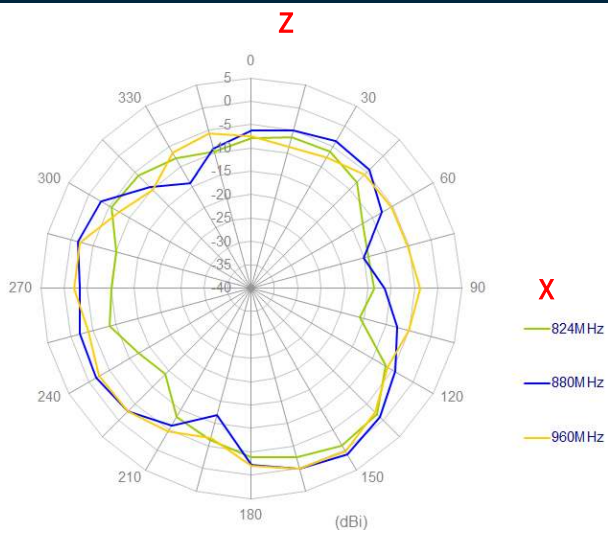

4.1 Test Setup

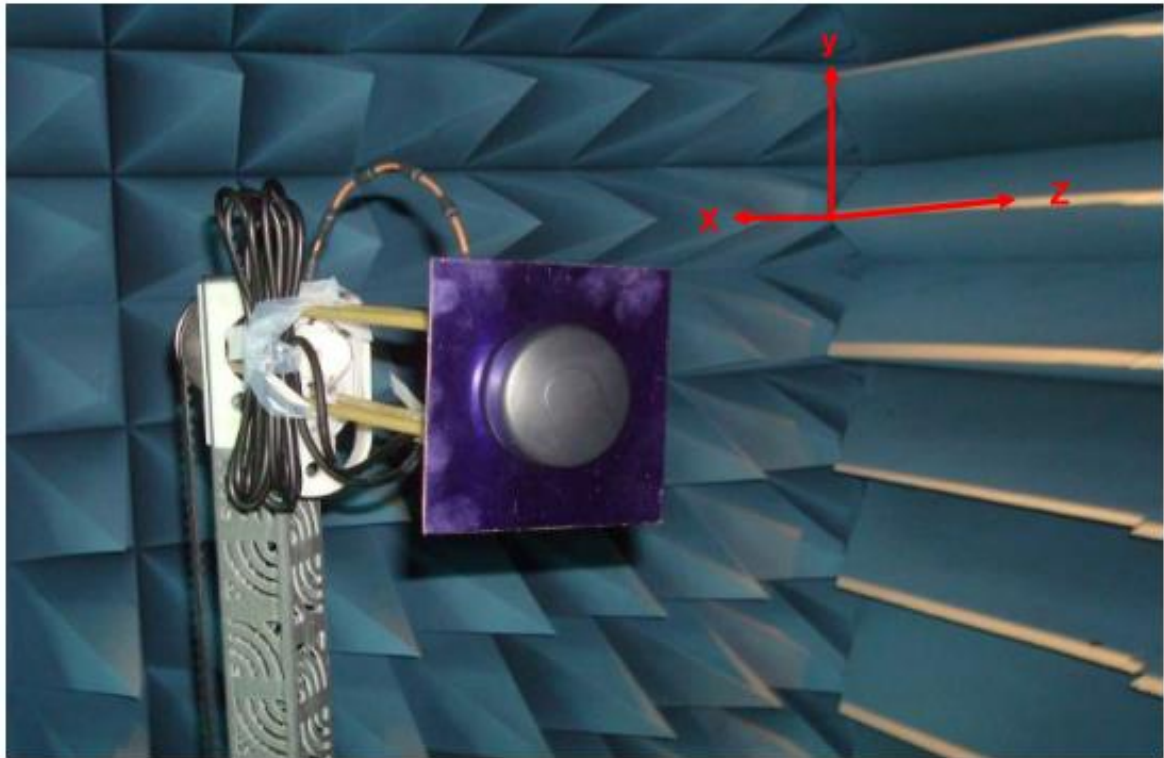

10x10m Ground Plane

XY Plane

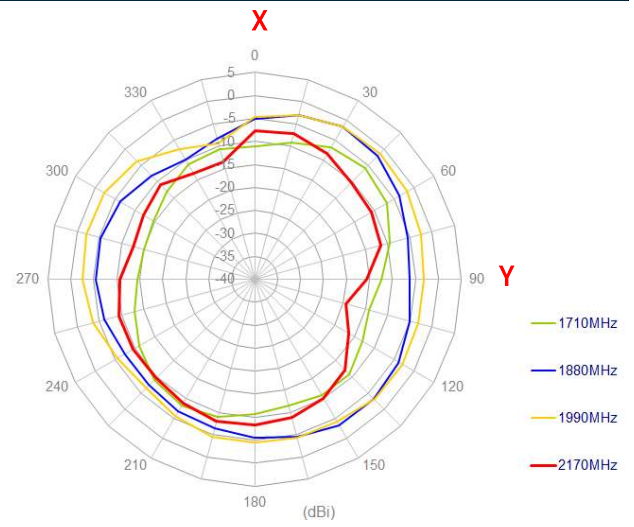
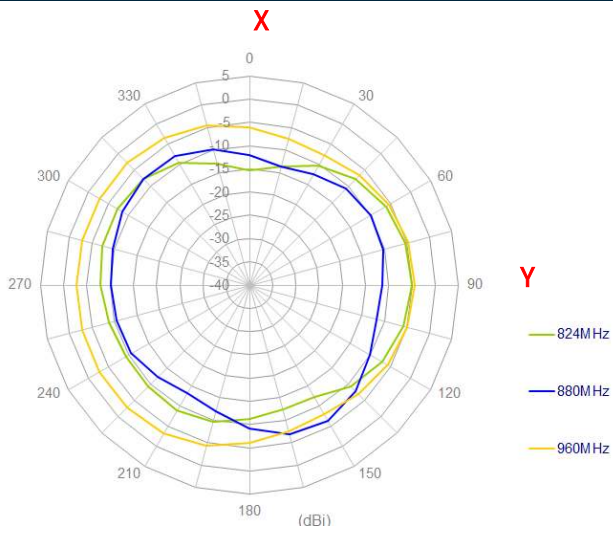

XZ Plane

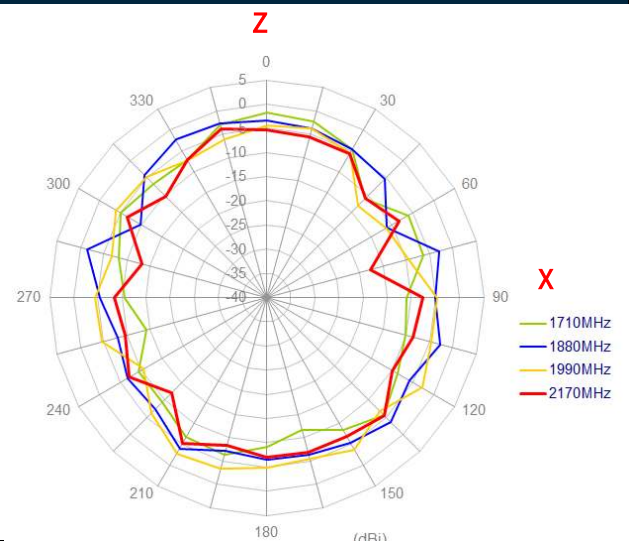
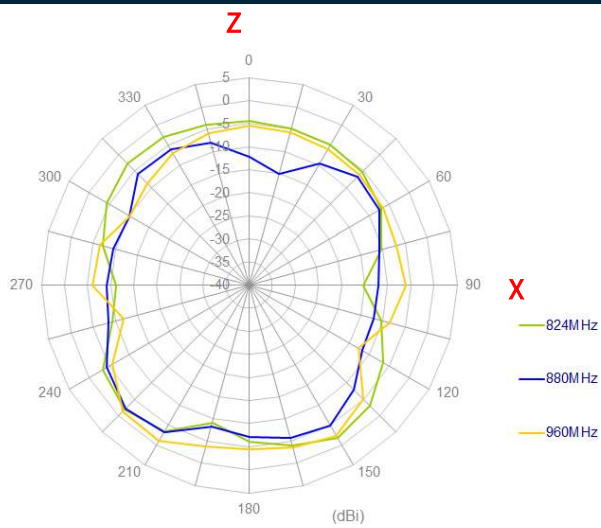

4.1 Test Setup



20x20cm Ground Plane

XY Plane

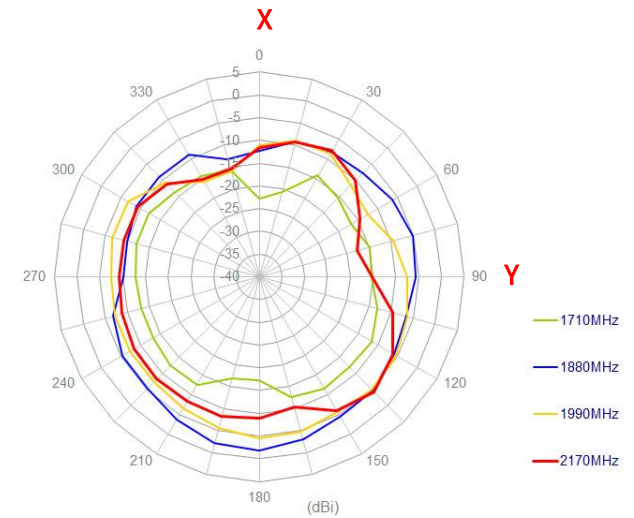
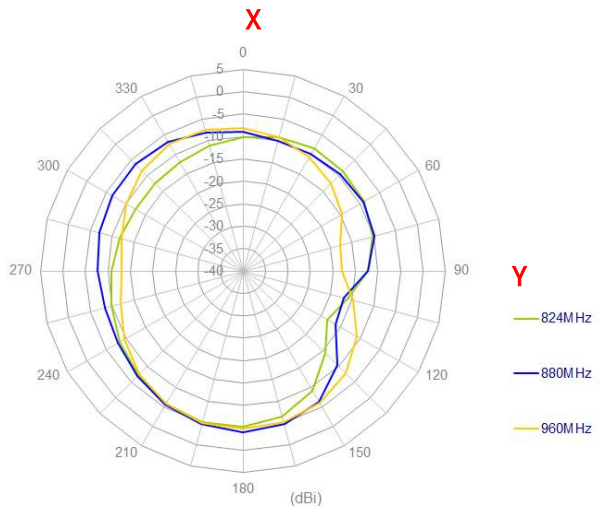

XZ Plane

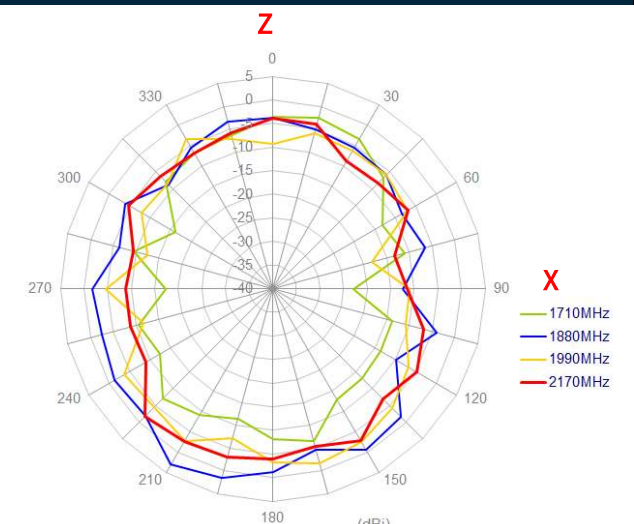
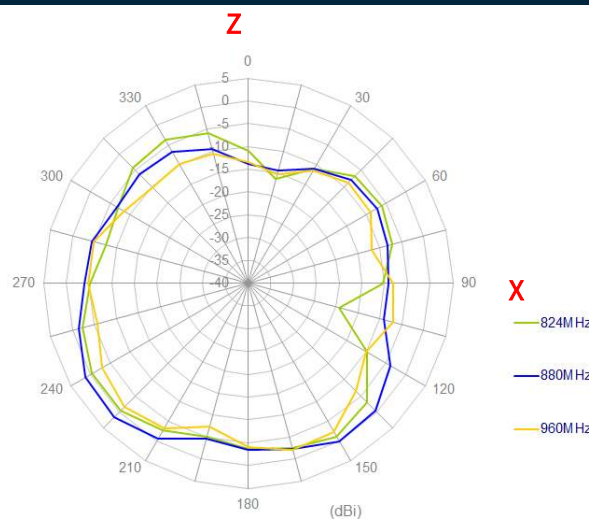

4.1 Test Setup

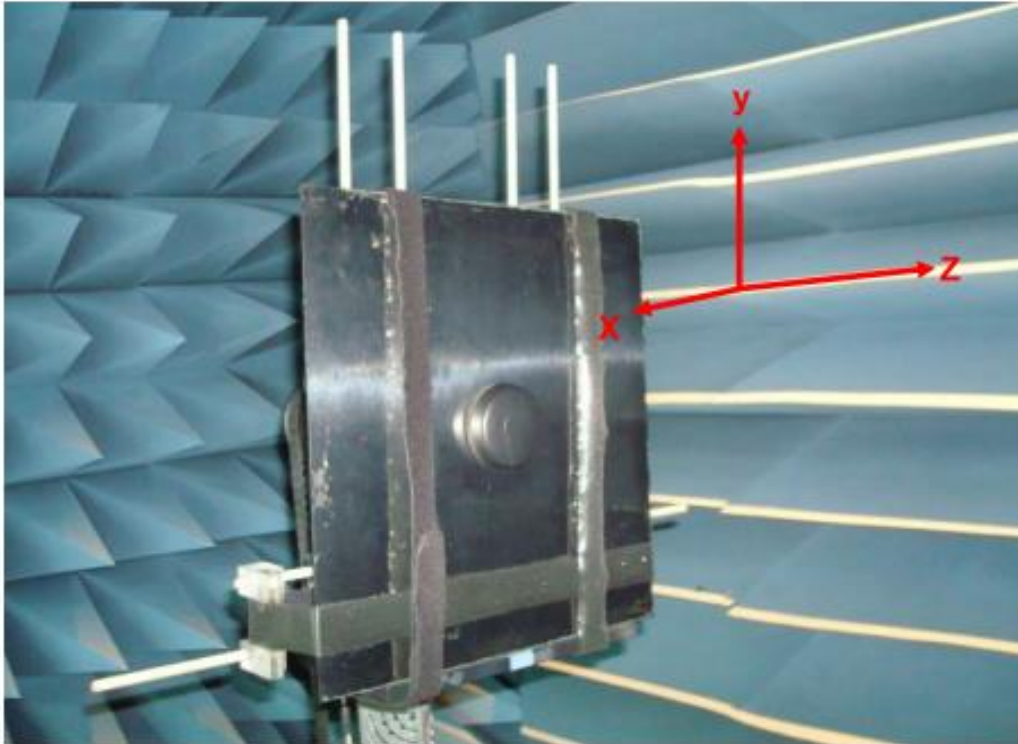

30x30cm Ground Plane

XY Plane

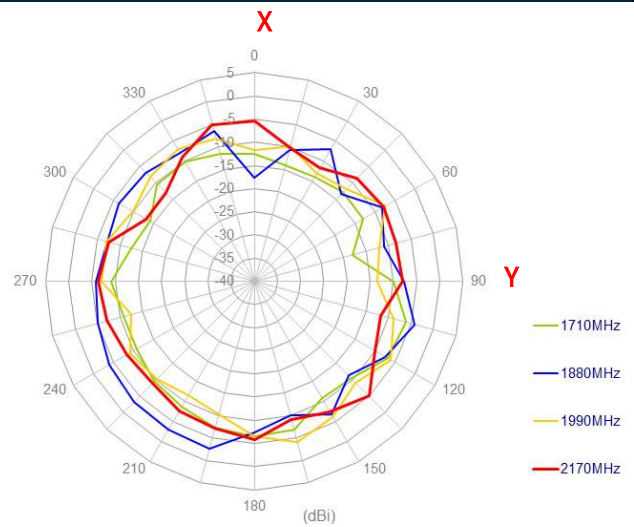
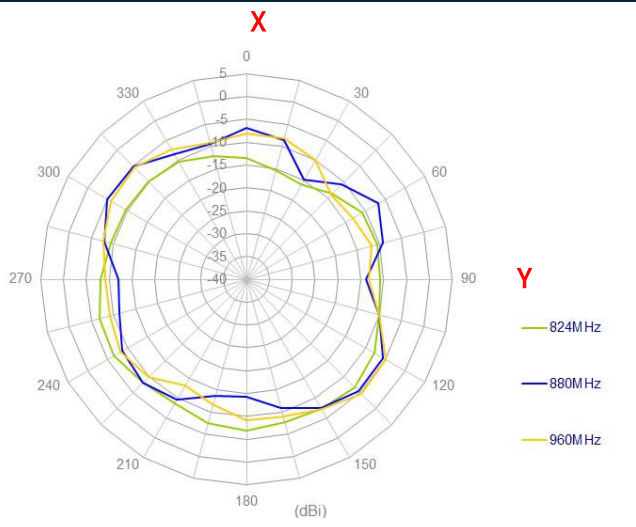

XZ Plane

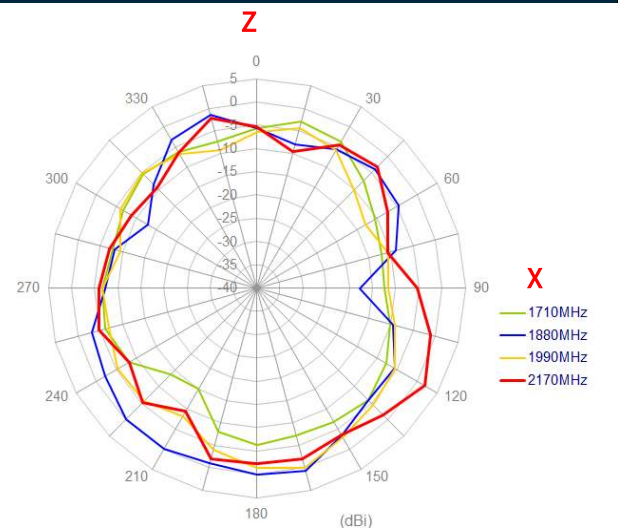
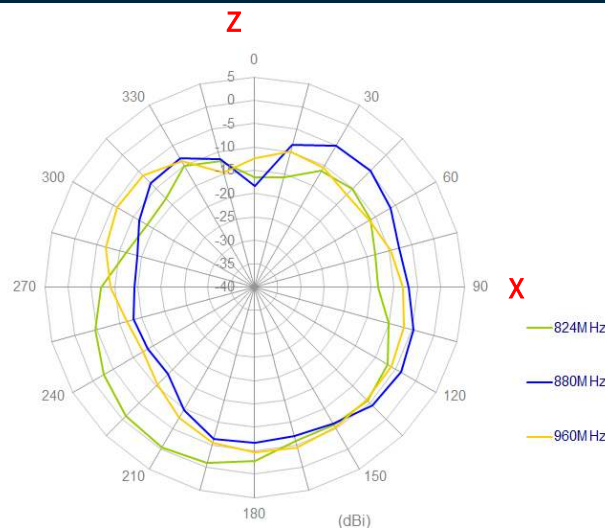

5. Installation

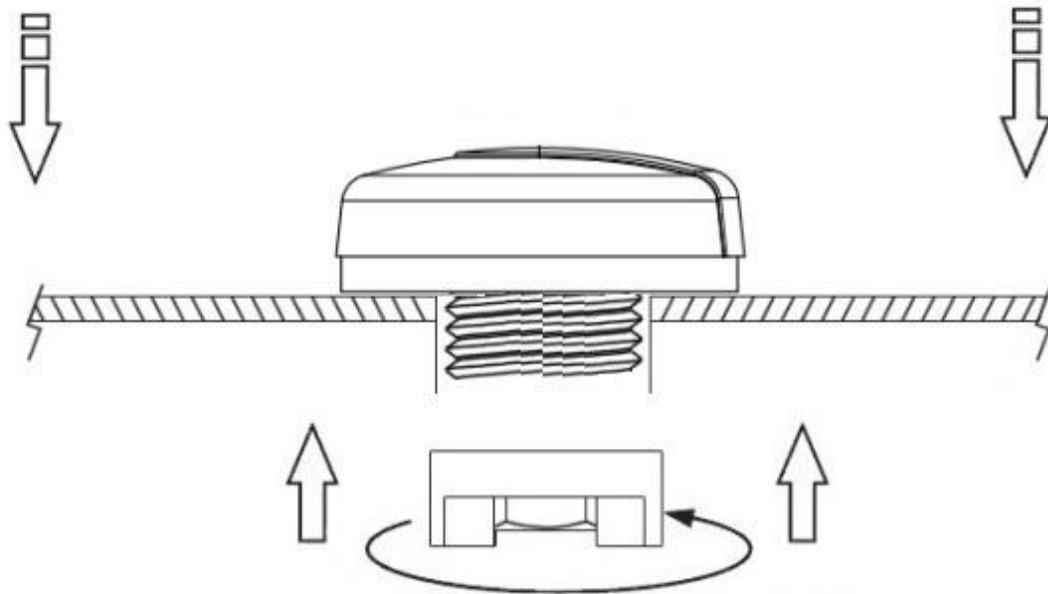

Recommended torque for Mounting is 3.92N·m
 Maximum torque for Mounting is 4.9N·m

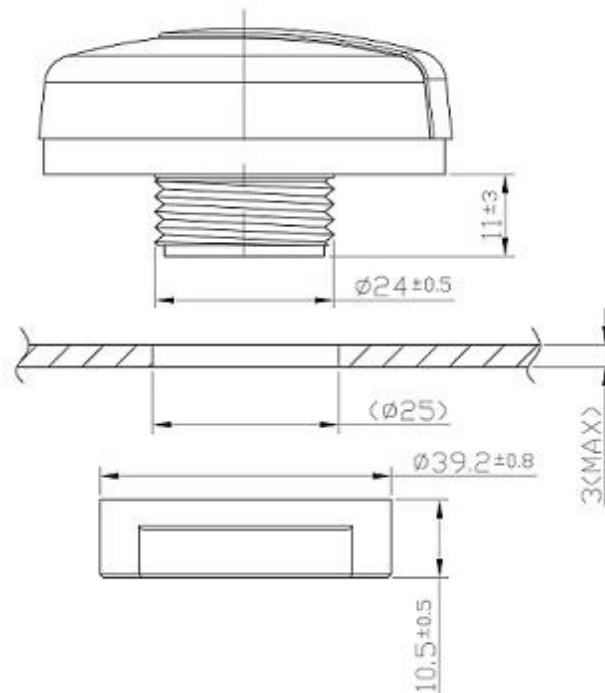

6. Mechanical Drawing (Units: mm)

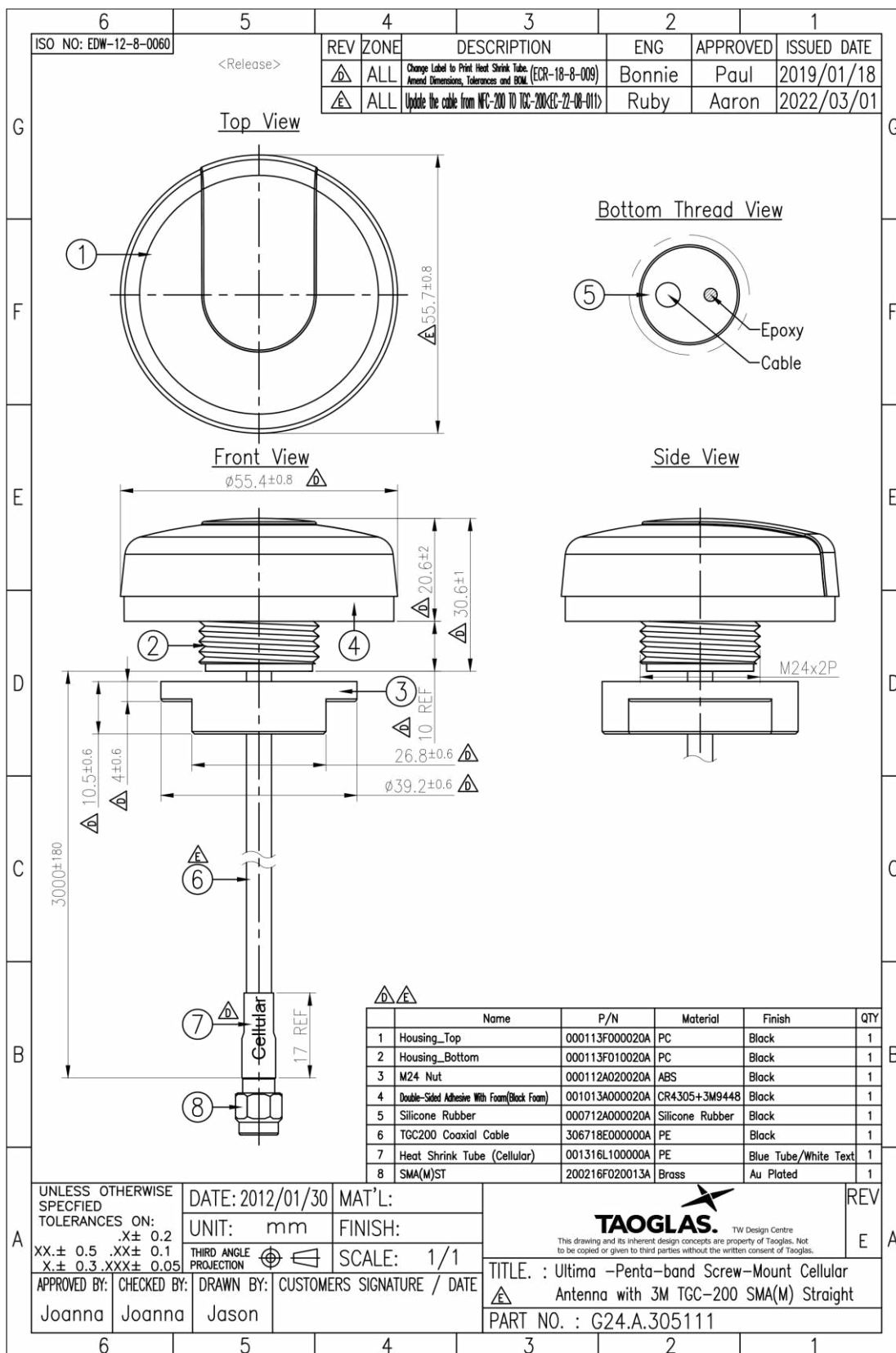

7. Packaging

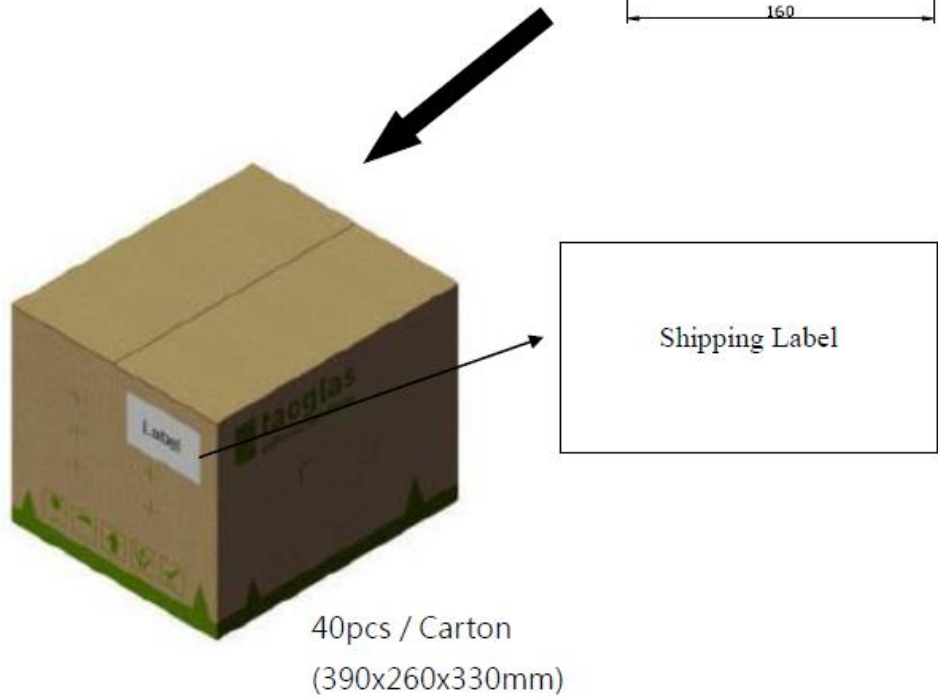
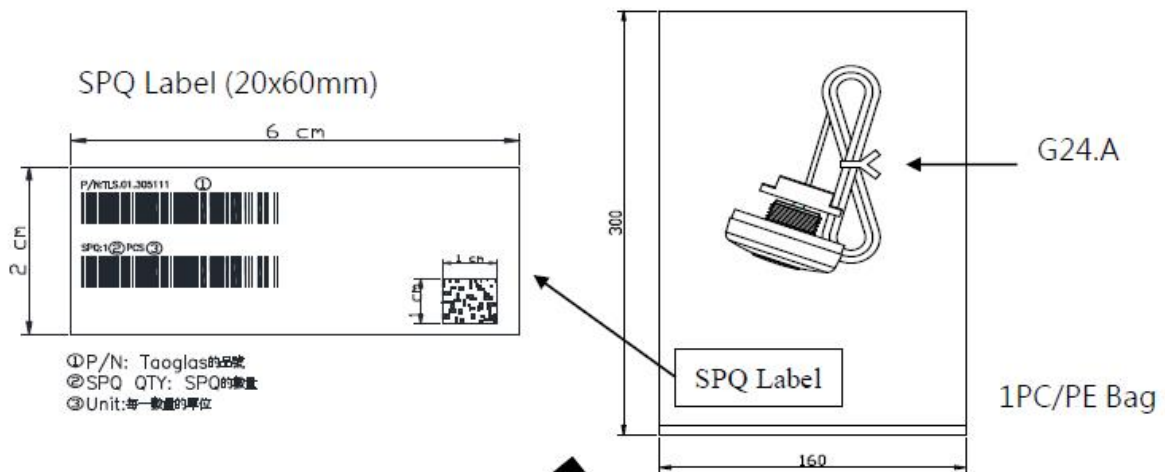



TAOGLAS®

www.taoglas.com

