

LOC	DIST	REVISIONS					
A	66	P	LTR	DESCRIPTION	DATE	DWN	APVD
			A3	SEE PRODUCT DRAWING	-	-	-

SEE PRODUCTION DRAWING
1852606

THIS DRAWING IS UNPUBLISHED.

ALL INTERNATIONAL RIGHTS RESERVED.

BY TYCO ELECTRONICS CORPORATION.

© COPYRIGHT

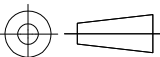
DIMENSIONS: INCHES	DWN	26AUG2010	MATERIAL	-	FINISH	-				
	CHK	M.YOUNGER	 Tyco Electronics Corporation Harrisburg, PA 17105-3608							
TOLERANCES UNLESS OTHERWISE SPECIFIED:	APVD	-	NAME							
	PRODUCT SPEC	-	SIDE FEED HDM APPLICATOR							
	APPLICATION SPEC	-	SIZE	CAGE CODE	DRAWING NO	RESTRICTED TO				
0 PLC ± - 1 PLC ± - 2 PLC ± - 3 PLC ± - 4 PLC ± - ANGLES ± -	WEIGHT	-	A4	00779	C-1852606	-				
			CUSTOMER DRAWING		SCALE	1:1	SHEET	1 OF 1	REV	A3