



Quad Freq LVPECL+CMOS Oscillator

4EA1250A0Z3

125 / 150 / 200 / 250MHz with 50MHz CMOS

ADVANCE DATASHEET

Features

- 4 LVPECL Frequencies: 125, 150, 200 & 250MHz
- 1 CMOS output: 50MHz
- Frequency Stability: ± 50 ppm
- Supply Voltage: 2.5V and 3.3V
- Standard Packages: 7.0 x 5.0 mm
- RMS phase jitter: 1 ps typical (12k to 20MHz)
- Operating Temperature: -40 to 85 °C

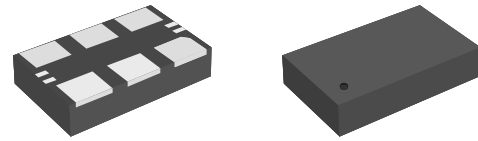

7.0 x 5.0 mm package

General Description

The 4EA1250A0Z3 is a quad frequency oscillator incorporating IDT's pMEMS technology to generate up to four LVPECL clock frequencies. An additional synchronous CMOS output is also provided for general purpose clocking. One 4EA1250A0Z3 can replace up to 5 separate crystal oscillators, reducing inventory and bill-of-material cost. The pinout and footprint is backward compatible to industry standard 7050 size oscillators, ensuring second source compatibility to traditional 6 pin SMD oscillators.

Functional Block Diagram

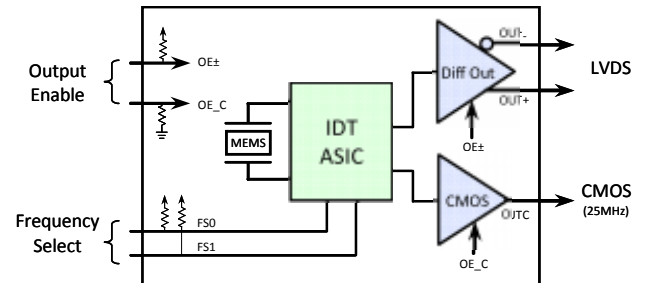

Pin Description

Pin	Name	Description
1	OE±	LVPECL Output Enable
6, 7	OUT+, OUT-	LVPECL Output
2	N/C	No connect
3, 8	GND, VDD	Supply Voltage
4, 5	FS0, FS1	Frequency Select
9	OE_C	CMOS Output Enable
10	OUTC	CMOS Output

Frequency Table

Input*	Output (MHz)	
	LVPECL	CMOS
FS[1,0]		
1,1	125.00	50.0
1,0	150.00	
0,1	200.00	
0,0	250.00	

* FS0, FS1 includes weak pull-up resistor

Enable/Disable

OE±*	LVPECL
HI	ON
LOW	OFF

*Includes weak pull-up resistor

OE_C*	CMOS
HI	ON
LOW	OFF

*Includes weak pull-down resistor

Output Waveform (LVPECL)

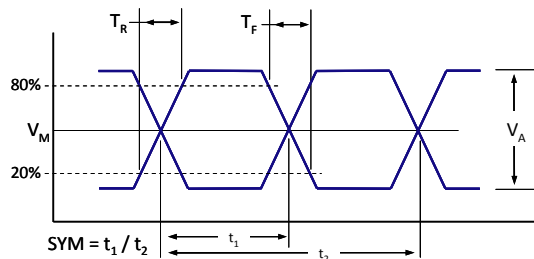

Output Waveform (CMOS)

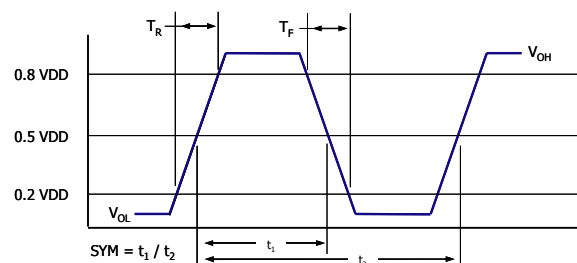

Part Ordering Information

Package Size	Voltage	Ordering Code
7.0 x 5.0 mm	3.3V	4EA1250A0Z3AACUGI
	2.5V	4EA1250A0Z3BACUGI

* Factory minimum order quantity: 500pcs (T/R)

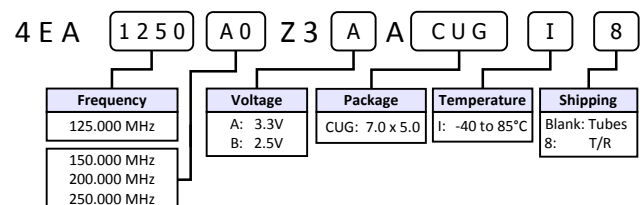

Specification

Parameter	2.5 V Specifications			3.3 V Specifications			Units	Conditions
	Min	Typ	Max	Min	Typ	Max		
Supply Voltage (V _{DD})	2.375	2.50	2.625	2.97	3.30	3.63	V	
Frequency Stability	- 50		+ 50	- 50		+ 50	ppm	Includes supply voltage and temperature variation (-40 to 85°C), reflow drift, and aging.
Supply Current		130			140		mA	No load
Enable/Disable Time			1			1	us	Guaranteed by design
Input HIGH/LOW level	0.7V _{DD}		0.3V _{DD}	0.7V _{DD}		0.3V _{DD}	V	At OE± & OE_C pins
Start-up Time		10			10		ms	Output valid time after power up, 25°C
Aging		± 5			± 5		ppm	25°C, 10 years
LVPECL Output								
Output LOW level		0.8	V _{DD} -1.8		1.5	V _{DD} -1.8	V	
Output HIGH level	V _{DD} -1.0	1.6		V _{DD} -1.1	2.3		V	
Amplitude (V _A)		0.75			0.75		V	Single Ended output swing (Pk-Pk)
Mid Level (V _M)		V _{DD} -1.3			V _{DD} -1.3		V	
Rise Time (T _R)		220	260		200	240	ps	Maximum; 20/80% of V _A ; Output load (CL) = 2pF; Guaranteed by Char.
Fall Time (T _F)		220	260		200	240	ps	Maximum; 20/80% of V _A ; Output load (CL) = 2pF; Guaranteed by Char.
Symmetry (SYM)	48	50	52	48	50	52	%	Worst case; measured at 50% of waveform
Phase Jitter		0.9			0.6		ps	12k to 20MHz, RMS; Measured Differentially
Period Jitter		2.6			2.4		ps	RMS
Cycle-to-Cycle Jitter		20			18		ps	1,000 cycles, Peak
CMOS Output (50MHz)								
Rise/Fall Time (T _R / T _F)		500			500		ps	Maximum; 20/80% of V _A ; Output load (CL) = 15pF
Symmetry (SYM)	48		52	48		52	%	Worst case; measured at 50% of waveform
Output HIGH/LOW level	V _{DD} -0.3		0.3	V _{DD} -0.3		0.3	V	I _{OL} =8mA; I _{OH} =-8mA
Period Jitter (rms)		25			20		ps	Measured over 10k cycles
Cycle to Cycle Jitter		120			100		ps	1,000 cycles, Peak

Package Outline and Dimensions

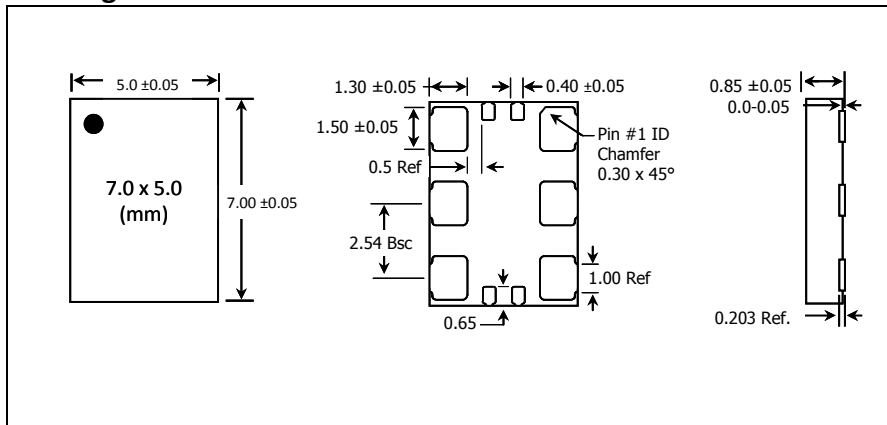

Typical PCB Land Pattern

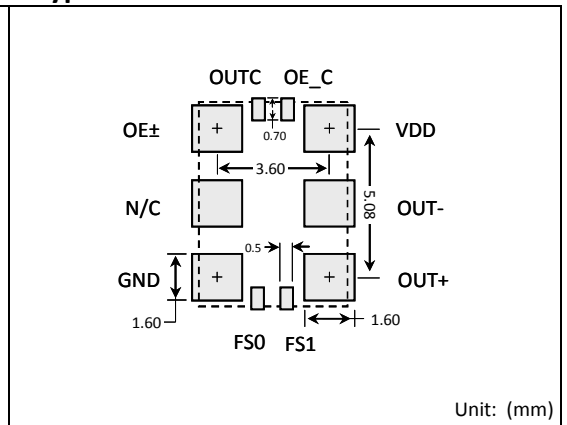

Unit: (mm)



www.IDT.com

6024 Silver Creek Valley Road
San Jose, California 95138

Sales

800-345-7015 (inside USA)
+1 408-284-8200 (outside USA)

Technical Support

MEMS_Support@idt.com
www.idt.com/go/MEMS

DISCLAIMER Integrated Device Technology, Inc. (IDT) and its subsidiaries reserve the right to modify the products and/or specifications described herein at any time and at IDT's sole discretion. All information in this document, including descriptions of product features and performance, is subject to change without notice. Performance specifications and the operating parameters of the described products are determined in the independent state and are not guaranteed to perform the same way when installed in customer products. The information contained herein is provided without representation or warranty of any kind, whether express or implied, including, but not limited to, the suitability of IDT's products for any particular purpose, an implied warranty of merchantability, or non-infringement of the intellectual property rights of others. This document is presented only as a guide and does not convey any license under intellectual property rights of IDT or any third parties. IDT's products are not intended for use in life support systems or similar devices where the failure or malfunction of an IDT product can be reasonably expected to significantly affect the health or safety of users. Anyone using an IDT product in such a manner does so at their own risk, absent an express, written agreement by IDT.

Integrated Device Technology, IDT and the IDT logo are registered trademarks of IDT. Other trademarks and service marks used herein, including protected names, logos and designs, are the property of IDT or their respective third party owners. Copyright 2010, 2011, 2012, 2013. All rights reserved.