



MAX5581 Evaluation Kit/Evaluation System

General Description

The MAX5581 evaluation system (EV system) is a complete, 4-channel, 12-bit, data-generation system. The MAX5581 EV system (MAX5581EVCMODU) consists of a MAX5581 evaluation kit (EV kit) and the Maxim CMODUSB command module. Order the EV kit (MAX5581EVKIT) separately if an SPI™ master or the CMODUSB command module is already available.

The EV kit comes with the MAX5581AETP installed. Contact the factory for free samples of the pin-compatible MAX5580_ETP–MAX5585ETP to evaluate these devices.

Component List

DESIGNATION	QTY	DESCRIPTION
C1, C4	2	10 μ F \pm 20%, 6.3V X5R ceramic capacitors (0805) TDK C2012X5R0J106M
C2, C3, C5, C6, C7	5	0.1 μ F \pm 10%, 16V X7R ceramic capacitors (0603) TDK C1608X7R1C104KT
FB1	1	Surface-mount ferrite bead (0603) TDK MMZ1608B601C
J1	1	2 x 20 right-angle female connector
J2	1	10-pin, 2 x 5 header
JU1, JU2, JU6	3	3-pin headers
JU3, JU4, JU5	0	Not installed (2-pin headers)
R1–R8	8	10k Ω \pm 0.1% resistors (0805)
R9–R16	0	Not installed (thru-hole resistors)
R17, R19	2	100k Ω \pm 5% resistors (0805)
R18, R20	2	1k Ω \pm 5% resistors (0805)
R21	1	10k Ω \pm 5% resistor (0805)
SW1, SW2	2	Pushbutton switches, momentary, normally open
U1	1	MAX5581AETP (20-pin thin QFN-EP)
U2	1	+2.5V voltage reference (8-pin SO) Maxim MAX6126AASA25
None	3	Shunts
None	1	MAX5581 EV kit blank PC board
None	1	MAX5581 EV kit software CD

SPI is a trademark of Motorola, Inc.

Windows is a registered trademark of Microsoft Corporation.



Maxim Integrated Products 1

For pricing, delivery, and ordering information, please contact Maxim/Dallas Direct! at 1-888-629-4642, or visit Maxim's website at www.maxim-ic.com.

Features

- ◆ Proven PC Board Layout
- ◆ Windows® 98-/2000-/XP-Compatible Evaluation Software
- ◆ Pushbutton Switches for Easy UPIO_ Evaluation
- ◆ Fully Assembled and Tested

Ordering Information

PART	INTERFACE TYPE
MAX5581EVKIT	User-supplied SPI master
MAX5581EVCMODU	Windows software

Note: The MAX5581 software is included with the MAX5581 EV kit but is designed for use with the complete EV system. The EV system includes both the Maxim command module and the EV kit. If the Windows software will not be used, the EV kit board can be purchased without the Maxim command module.

Note: To evaluate the MAX5580_ETP–MAX5585ETP, request a free sample when ordering the MAX5581 EV kit.

MAX5581EVCMODU Component List

PART	QTY	DESCRIPTION
MAX5581EVKIT	1	MAX5581 EV kit
CMODUSB	1	CMODUSB command module

Component Supplier

SUPPLIER	PHONE	WEBSITE
TDK	847-803-6100	www.component.tdk.com

Note: Indicate you are using the MAX5581 when contacting this component supplier.

MAX5581EV Kit Files

INSTALL.EXE	Installs the EV kit files on your computer
MAX5581.EXE	Application program
HELPPFILE.HTM	MAX5581 EV kit help file
FTD2XX.INF	USB driver file
UNINST.INI	Uninstalls the EV kit software

Evaluate: MAX5580–MAX5585

MAX5581 Evaluation Kit/Evaluation System

Quick Start

Recommended Equipment

- MAX5581EVCMODU EV system (MAX5581EVKIT and CMODUSB command module with USB cable included)
- Power supply: 5V at 100mA (AVDD)
- Digital voltmeter (DVM)
- A user-supplied Windows 98/2000/XP PC with an available USB port

Procedure

Do not turn on the power until all connections are made.

- 1) Verify jumper J1 on the CMODUSB module is connected to pins 1-2. This sets the logic supply to 5V.
- 2) Verify that JU1 on the MAX5581 EV kit is set to 2-3 (DAC outputs are set to zero on power-up).
- 3) Verify that JU2 on the MAX5581 EV kit is set to 2-3 (UPIO1 connected to SPI MISO (DOUT) line).
- 4) Verify that JU6 on the MAX5581 EV kit is set to 1-2 (SPI data is clocked in on the rising edge of SCLK).
- 5) Connect the MAX5581 EV kit's 40-pin female connector (J1) to the CMODUSB module's 40-pin male connector (P4).
- 6) Install the MAX5581 evaluation software on your computer by running the INSTALL.EXE program on the installation CD-ROM. The program files are copied and icons are created for them in the Windows **Start** menu.
- 7) Connect the 5V power supply between the MAX5581 EV kit's AVDD and AGND pads. Turn on the 5V power supply.
- 8) Connect the included USB cable from the PC to the CMODUSB command module. A **Building Driver Database** window will pop up in addition to a **New Hardware Found** message. If you do not see any window that is similar to the one described above after 30s, try removing the USB cable from the CMODUSB command module and reconnect it again. Administrator privileges are required to install the USB device driver on Windows 2000/XP.
- 9) Follow the directions of the **Add New Hardware Wizard** to install the USB device driver. Choose the **Search for the best driver for your device** option. Specify the location of the device driver to be C:\Max5581 using the **Browse** button.
- 10) Start the MAX5581 EV kit software by opening its icon in the **Start** menu.
- 11) Using the **Load Input and Output (From Shift) Tab**, press the **Load All DACs** button.
- 12) Verify that all **Output Register Code** and **Voltage** labels update with 0x800 and 1.25V, respectively, at the bottom of the MAX5581 EV kit software's main window.
- 13) Measure the voltage at OUTA (J2-1) using the DVM and verify that the voltage is approximately 1.25V.

Detailed Description of Software

The evaluation software's main window, shown in Figure 1, displays the voltage and code for all DAC input and output registers. In addition, the main window also shows the shutdown and settling time status for all of the DACs. Table 1 describes the controls that are always present on the evaluation software's main window.

MAX5581 Evaluation Kit/Evaluation System

Evaluate: MAX5580-MAX5585

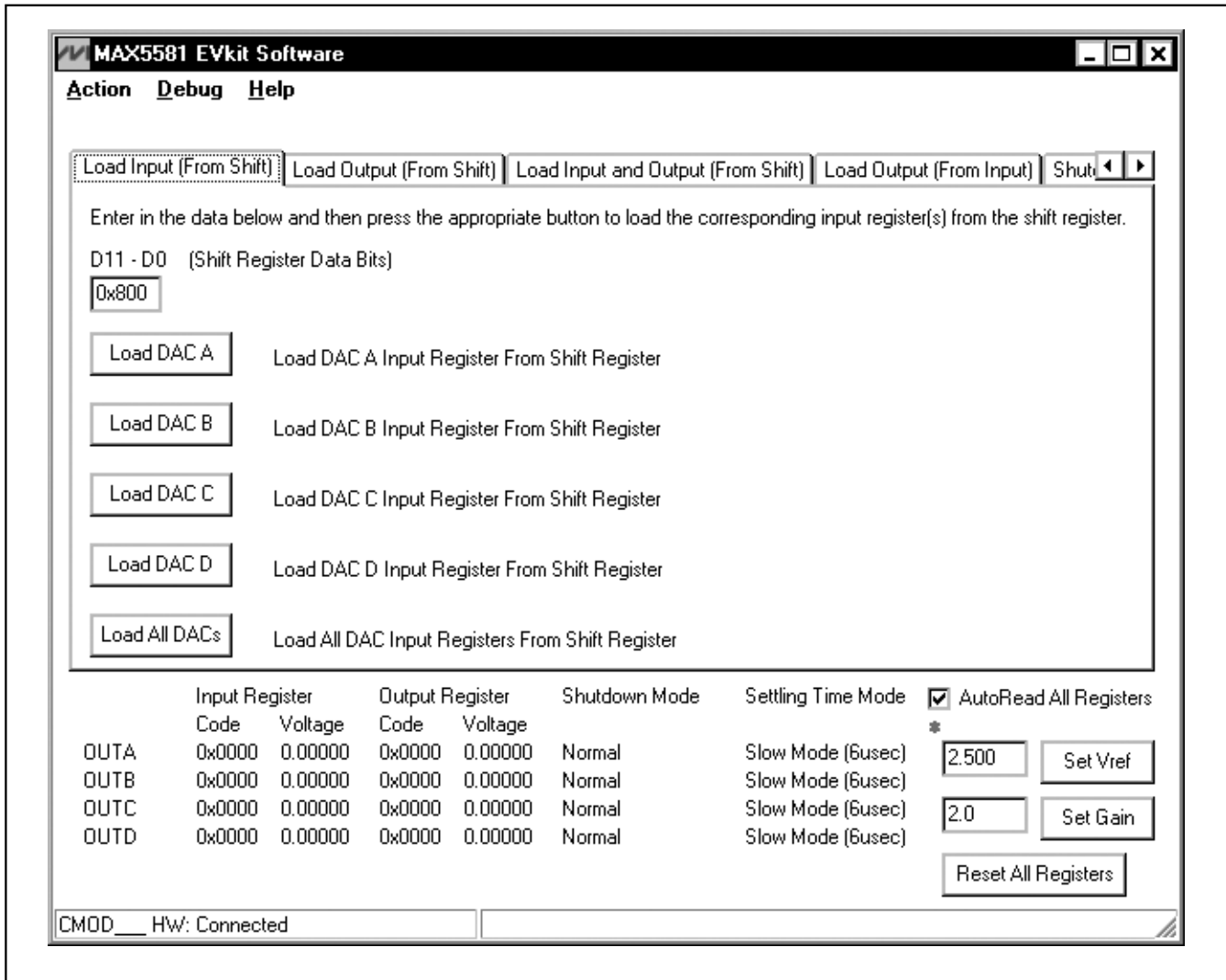

Figure 1. MAX5581 Evaluation Software—Main Window

MAX5581 Evaluation Kit/Evaluation System

Evaluate: MAX5580-MAX5585

Table 1. MAX5581 EV Kit Software—Main Window Control Descriptions

CONTROL	DESCRIPTION
Action	Allows the user to select the active tab.
Debug	Shows the CMODUSB debugging tools.
Help	Gives access to the help file and the about box.
Input Register Code Voltage 0x0000 0.00000 0x0000 0.00000 0x0000 0.00000 0x0000 0.00000	Shows the code and voltage for the input register of DAC A–DAC D.
Output Register Code Voltage 0x0000 0.00000 0x0000 0.00000 0x0000 0.00000 0x0000 0.00000	Shows the code and voltage for the output register of DAC A–DAC D.
Shutdown Mode Shutdown (1k Ohm) Normal Normal Shutdown (High-Z)	Shows the shutdown mode and shutdown status of DAC A–DAC D.
Settling Time Mode Slow Mode (6usec) Slow Mode (6usec) Fast Mode (3usec) Fast Mode (3usec)	Shows the settling time mode of DAC A–DAC D.
<input type="checkbox"/> AutoRead All Registers *	When checked, automatically reads and updates all the register information for the registers that are permanently on the bottom of the software’s main window. A flashing asterisk indicates AutoRead All Registers is active.
<input type="text" value="2.500"/> <input type="button" value="Set Vref"/>	Allows the user to enter the actual measured on-board reference value or the actual value of a user-supplied external reference. Pressing the Set Vref button uses the value typed in the edit to calculate the corresponding input and output register voltages.
<input type="text" value="2.0"/> <input type="button" value="Set Gain"/>	Allows the user to enter the gain of the output amplifier. Pressing the Set Gain button uses the value typed in the edit box to calculate the corresponding input and output register voltages. The MAX5581 EV kit board has on-board resistors that set the default gain to 2. To change the gain, modify the on-board gain-setting resistors by referring to the MAX5581 data sheet before changing the gain in the software. For unity-gain device evaluation, set the gain to 1 and remove the output feedback resistors to prevent loading the output.
<input type="button" value="Reset All Registers"/>	Resets all the registers and status information that is permanently on the bottom of the software’s main window as shown in Figure 1.

MAX5581 Evaluation Kit/Evaluation System

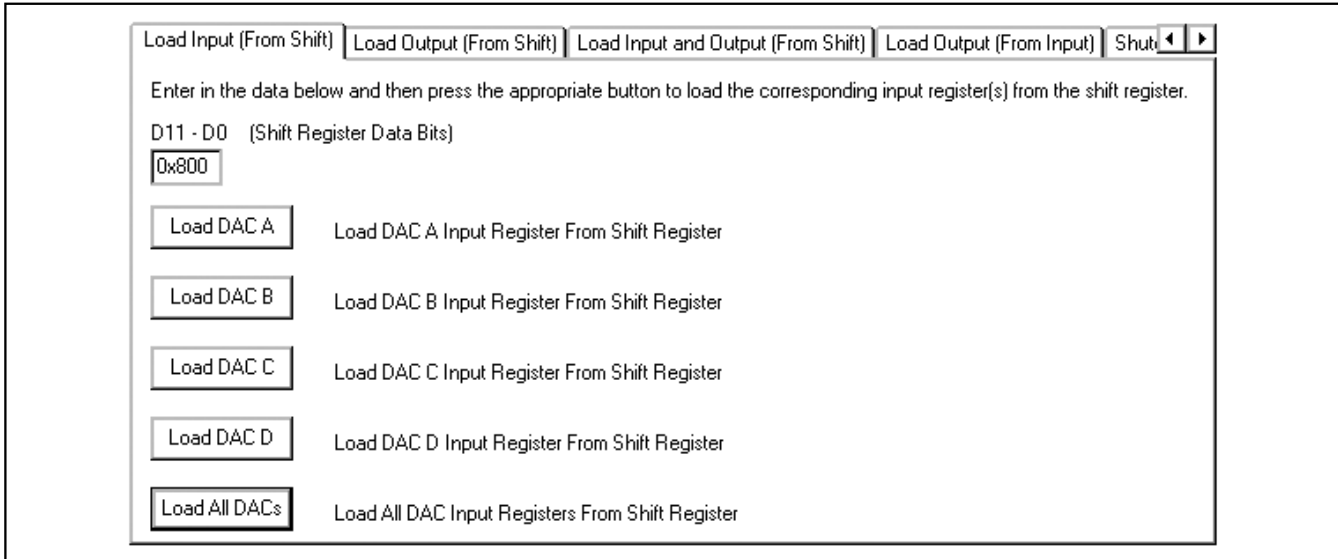

Figure 2. Load Input (From Shift) Tab

The **Load Input (From Shift)** tab, shown in Figure 2, allows the user to load the input register of the corresponding DAC with the data that is sent to the shift register. The user can load all four DACs individually or all at once by pressing the appropriate button. If the **AutoRead All Registers** checkbox is checked (see Figure 1), the new input register value is updated to the software's main window.

The **Load Output (From Shift)** tab, shown in Figure 3, allows the user to load the output register of the corresponding DAC with the data that is sent to the shift register. The user can load all four DACs individually by pressing the appropriate button. If the **AutoRead All Registers** checkbox is checked (see Figure 1), the new output register value is updated to the software's main window.

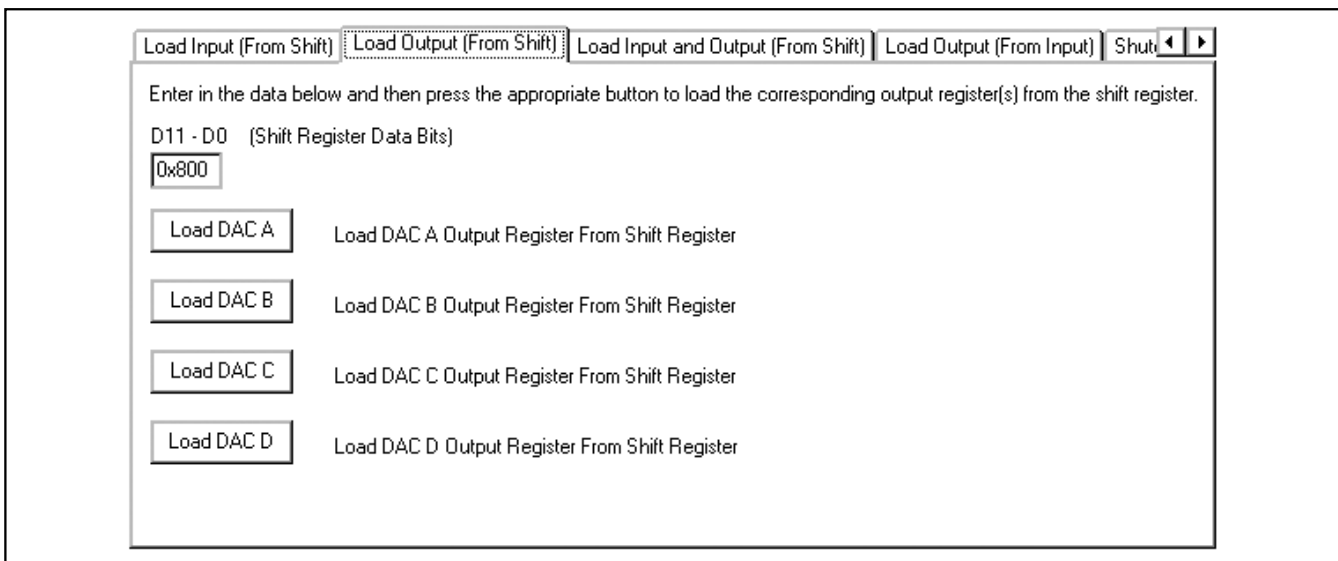

Figure 3. Load Output (From Shift) Tab

MAX5581 Evaluation Kit/Evaluation System

The **Load Input and Output (From Shift)** tab, shown in Figure 4, allows the user to load the input and output registers of the corresponding DAC with the data that is sent to the shift register. The user can load all four DACs

individually or all at once by pressing the appropriate button. If the **AutoRead All Registers** checkbox is checked (see Figure 1), the new input and output register values are updated to the software's main window.

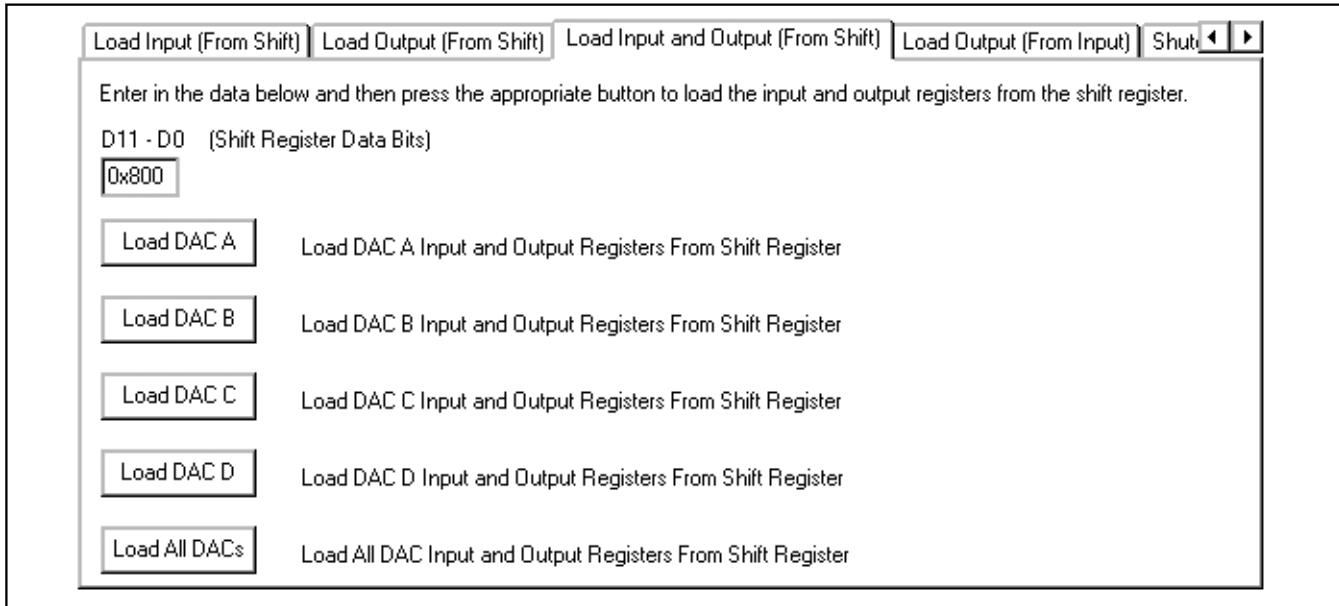

Figure 4. Load Input and Output (From Shift) Tab

MAX5581 Evaluation Kit/Evaluation System

The **Load Output (From Input)** tab, shown in Figure 5, allows the user to load the output register of the corresponding DAC with the data that is present in the corresponding input register. The user can load the four DACs simultaneously in any combination by checking the appropriate **DAC_** checkbox and then pressing the

Load Checked DACs button. It is also possible to load all of the DACs at once by pressing the **Load All DACs** button. If the **AutoRead All Registers** checkbox is checked (see Figure 1), the new output register values are updated to the software's main window.

Evaluate: MAX5580-MAX5585

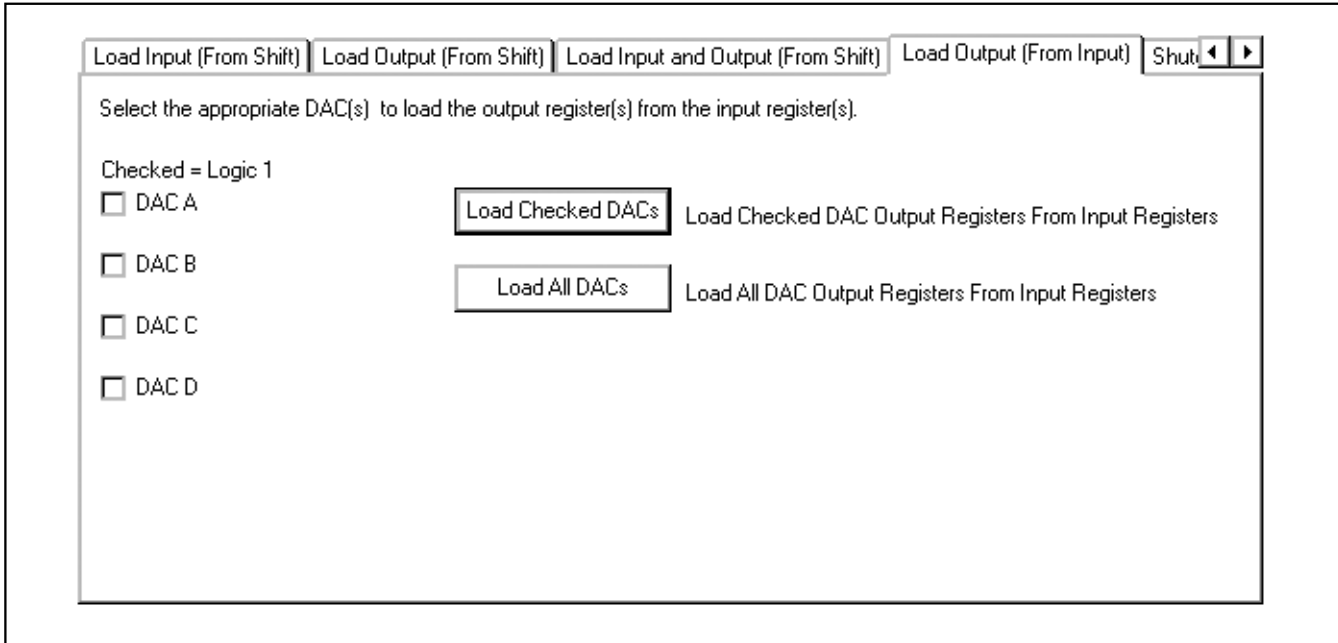

Figure 5. Load Output (From Input) Tab

MAX5581 Evaluation Kit/Evaluation System

The **Shutdown Modes** tab, shown in Figure 6, allows the user to select the appropriate DAC shutdown mode individually for all four DACs. The selected shutdown modes are not loaded until the **Load DAC A-D**

Shutdown Modes button is pressed. If the **AutoRead All Registers** checkbox is checked (see Figure 1), the new shutdown mode status for each DAC is updated to the software's main window.

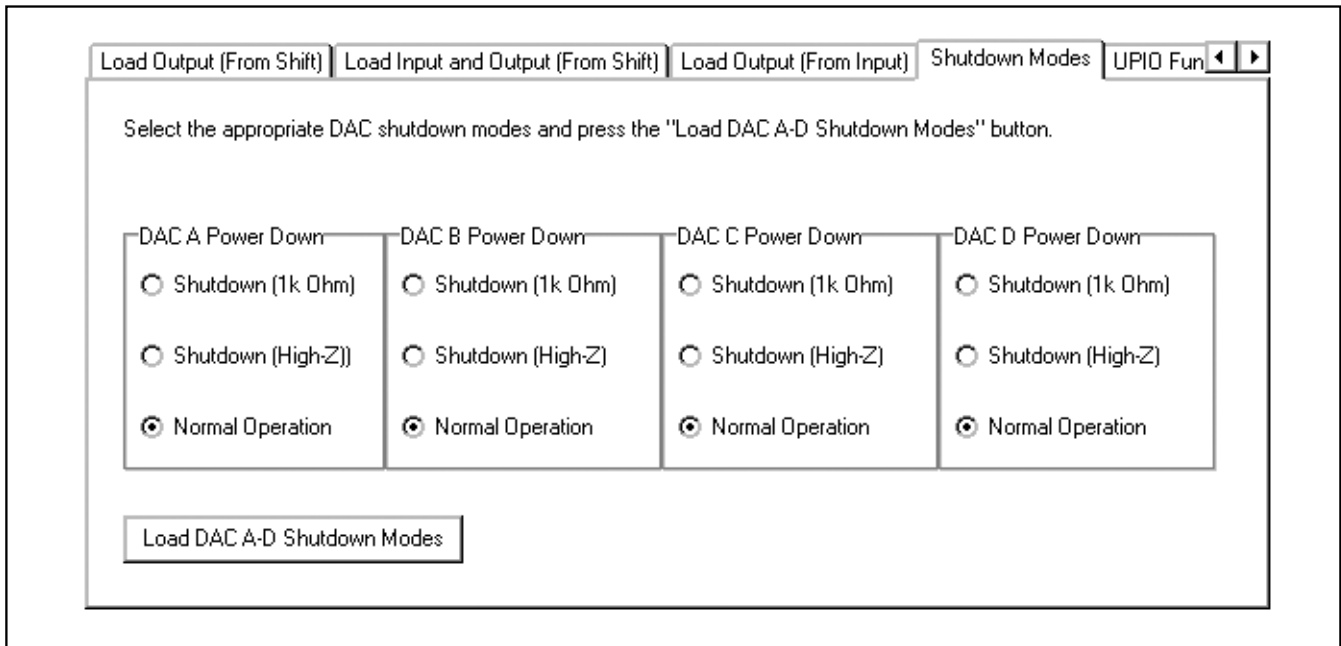

Figure 6. Shutdown Modes Tab

MAX5581 Evaluation Kit/Evaluation System

The **UPIO Functions** tab, shown in Figure 7, allows the user to select the appropriate UPIO1 and UPIO2 functions using the corresponding combobox. The current UPIO1 and UPIO2 function status is displayed by pressing the **Read** button.

Note: For the MAX5581 EV kit software to read from the MAX5581 device, UPIO1 must be configured for DOUTRB.

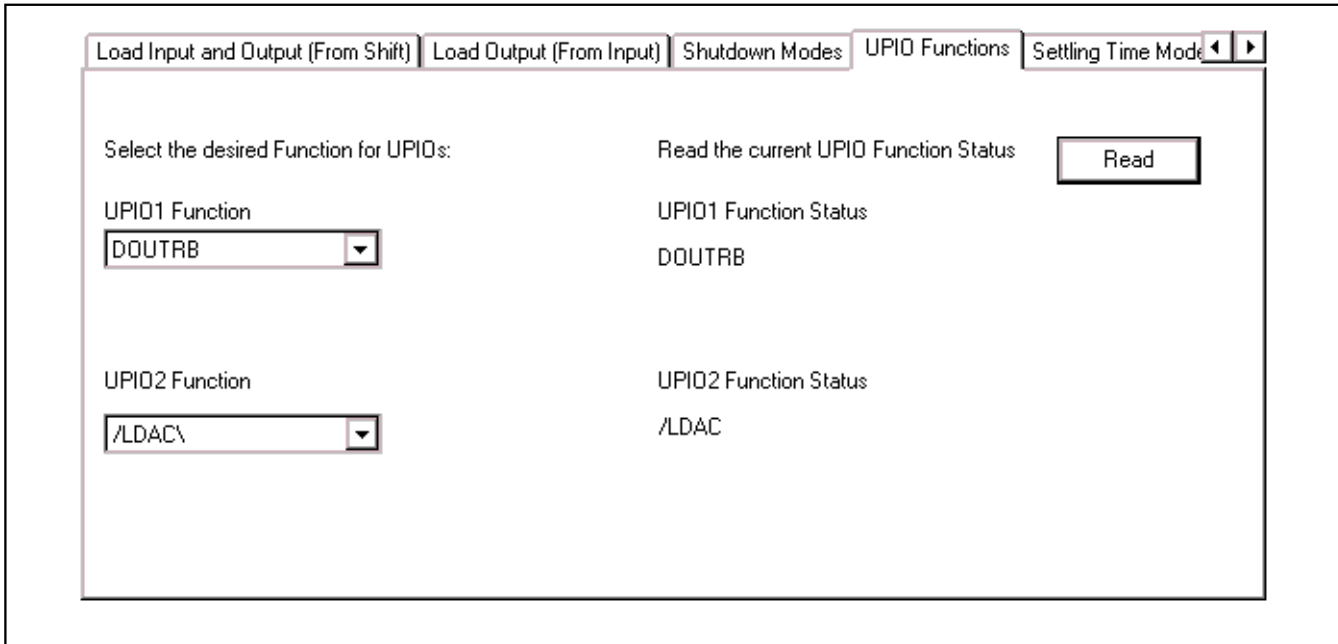

Figure 7. UPIO Functions Tab

Evaluate: MAX5580-MAX5585

MAX5581 Evaluation Kit/Evaluation System

The **Settling Time Modes** tab, shown in Figure 8, allows the user to select the appropriate DAC settling time mode individually for all four DACs. The selected settling time modes are not loaded until the **Load DAC**

A-D Settling Time Modes button is pressed. If the **AutoRead All Registers** checkbox is checked (see Figure 1), the new settling time modes for each DAC are updated to the software's main window.

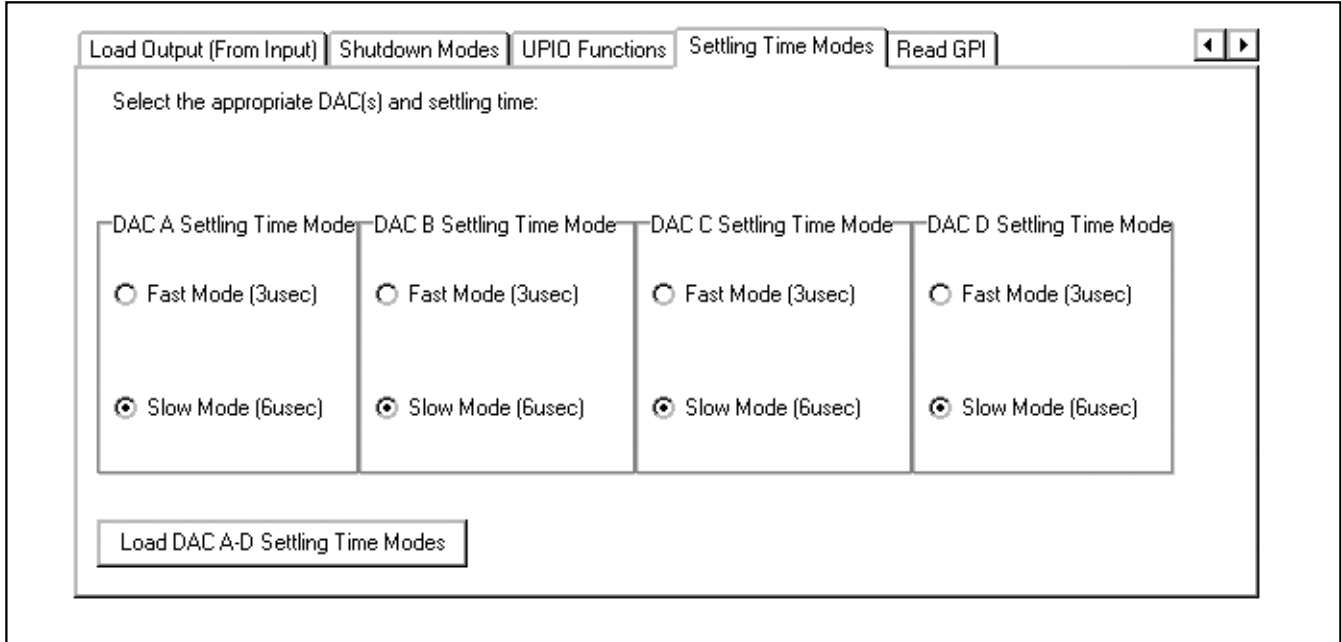

Figure 8. Settling Time Modes Tab

MAX5581 Evaluation Kit/Evaluation System

The **Read UPIO Inputs** tab, shown in Figure 9, allows the user to read the GPI status for UPIO2. Pressing the **Read** button not only tells the user whether a falling edge or rising edge has occurred since the last read, but also the current state of the pin.

Note: This read requires that UPIO1 be configured for DOUTRB and UPIO2 be configured as a GPI.

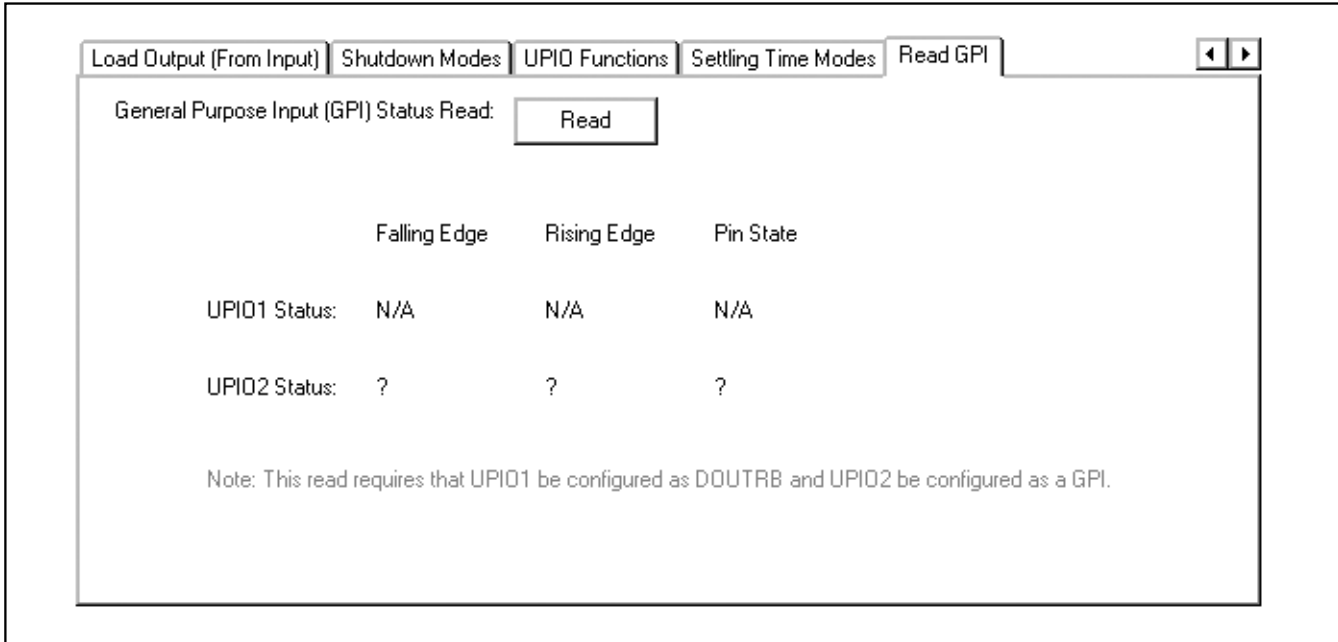

Figure 9. Read GPI Tab

Detailed Description of Hardware

MAX5581 EV System

The MAX5581 EV system is a complete, 4-channel, 12-bit, data-generation system consisting of a MAX5581 EV kit and the Maxim CMODUSB command module.

CMODUSB Command Module

The CMODUSB uses a proprietary design to provide SPI- and I²C-compatible interfaces to demonstrate various Maxim devices. Maxim reserves the right to change the implementation of this module at any time with no advance notice.

CMODUSB Power Supply

The CMODUSB board uses a MAX1658 linear voltage regulator. Jumper J1 selects between a 5V or 3.3V system supply voltage. **Do not plug a wall cube into the P1 power jack since power is provided from the USB port.**

Table 2. CMODUSB Jumper J1 (System Supply Voltage)

JUMPER	SHUNT POSITION	SYSTEM SUPPLY VOLTAGE (DVDD)
J1	1-2	5V
	2-3	3.3V
	Open	DO NOT OPERATE KIT WITH J1 OPEN. PERMANENT DAMAGE WILL RESULT.

MAX5581 Evaluation Kit/Evaluation System

MAX5581 EV Kit

The MAX5581 EV kit board provides a proven layout for evaluating the MAX5581 4-channel, 12-bit DAC and can be obtained separately without the CMODUSB command module. The MAX5581 EV kit contains an on-board reference and two momentary pushbutton switches for testing the UPIO functions. The MAX5581AETP (U1) is powered from two sources. The user must supply +5V to AVDD. DVDD is provided by the CMODUSB command module.

The DAC outputs can be set to full scale, midscale, or zero at power-up. Jumper JU1 configures the DAC outputs at power-up as shown in Table 3.

Jumper JU2 gives the user the flexibility to connect UPIO1 to the CMODUSB command module's SPI MISO line (DOUT) or to a UPIO1 user pad on the MAX5581 EV kit board. Table 4 shows the UPIO1 route selection.

Table 3. Power-Up State Select Input (PU)

JUMPER	SHUNT POSITION	DESCRIPTION
JU1	1-2	DAC outputs set to full scale upon power-up.
	2-3*	DAC outputs set to zero upon power-up.
	Open	DAC outputs set to midscale upon power-up.

*Default configuration.

Table 4. UPIO1 Route Selection (DOUT/UPIO1)

JUMPER	SHUNT POSITION	DESCRIPTION
JU2	1-2	UPIO1 user pad.
	2-3*	CMODUSB's SPI MISO line (DOUT). Required for readback commands in MAX5581 EV kit software.

*Default configuration.

Table 5. Reference Selection (REF)

JUMPER	PC BOARD TRACE	DESCRIPTION
JU3	Short*	On-board MAX6126 +2.5V reference option.
	Open	Cut the trace and attach an external reference to the REF pad.

*Default configuration.

The MAX5581 EV kit has an on-board MAX6126 +2.5V reference, but also allows for a user-supplied external reference (0.25V to AVDD). Cut the PC board trace designated by jumper JU3 and apply an external reference to the REF pad. Table 5 shows the jumper JU3 reference type options.

Measure the supply current using jumpers JU4 and JU5. Cut the PC board traces and place a current meter in series with the two terminals of the corresponding jumper. Table 6 shows the jumper JU4/JU5 current measurement options.

Jumper JU6 allows the user to select the clock edge that latches-in the SPI data. Table 7 shows the jumper JU6 clock edge options.

Table 6. Supply Current Measurement (IAVDD/IDVDD)

JUMPER	PC BOARD TRACE	DESCRIPTION
JU4/JU5	Short*	Normal operation.
	Open	Cut the trace and attach a current meter in series with the two open terminals to measure the supply current of AVDD (JU4) and DVDD (JU5).

*Default configuration.

Table 7. Data Latch-In Clock Edge Select (DSP)

JUMPER	SHUNT POSITION	DESCRIPTION
JU6	1-2*	Data latched in on the rising edge of SCLK.
	2-3	Data latched in on the falling edge of SCLK.

*Default configuration.

MAX5581 Evaluation Kit/Evaluation System

General Troubleshooting

Problem 1: CMODUSB module hardware not found (see Figure 10).

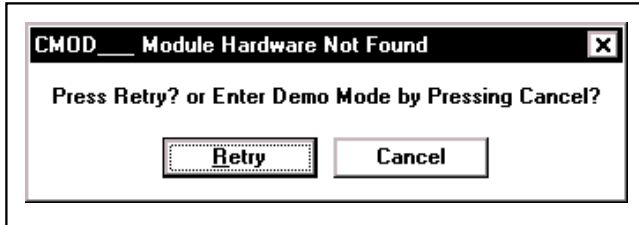

Figure 10. EV Kit Software Warning Message

Solution 1:

- Verify that the power LED is lit.
- Verify that the USB cable is connected.

Problem 2: The register data at the bottom of the MAX5581 evaluation software's main window is not correct (see Figure 1).

Solution 2:

- Verify that UPIO1 is configured for DOUTRB.
- Verify that the **AutoRead All Registers** checkbox is checked.
- Verify that the shunt for jumper JU6 is connected to pins 1-2.
- Verify that the shunt for jumper JU2 is connected to pins 2-3.
- Verify that the USB cable is connected.

Problem 3: Pressing the **Read** button in the **Read UPIO Inputs** tab gives incorrect status (see Figure 7).

Solution 3:

- Verify that UPIO2 is configured as a GPI.
- Verify that UPIO1 is configured for DOUTRB.
- Verify that the shunt for jumper JU6 is connected to pins 1-2.
- Verify that the shunt for jumper JU2 is connected to pins 2-3.
- Verify that the USB cable is connected.

MAX5581 Evaluation Kit/Evaluation System

Evaluate: MAX5580-MAX5585

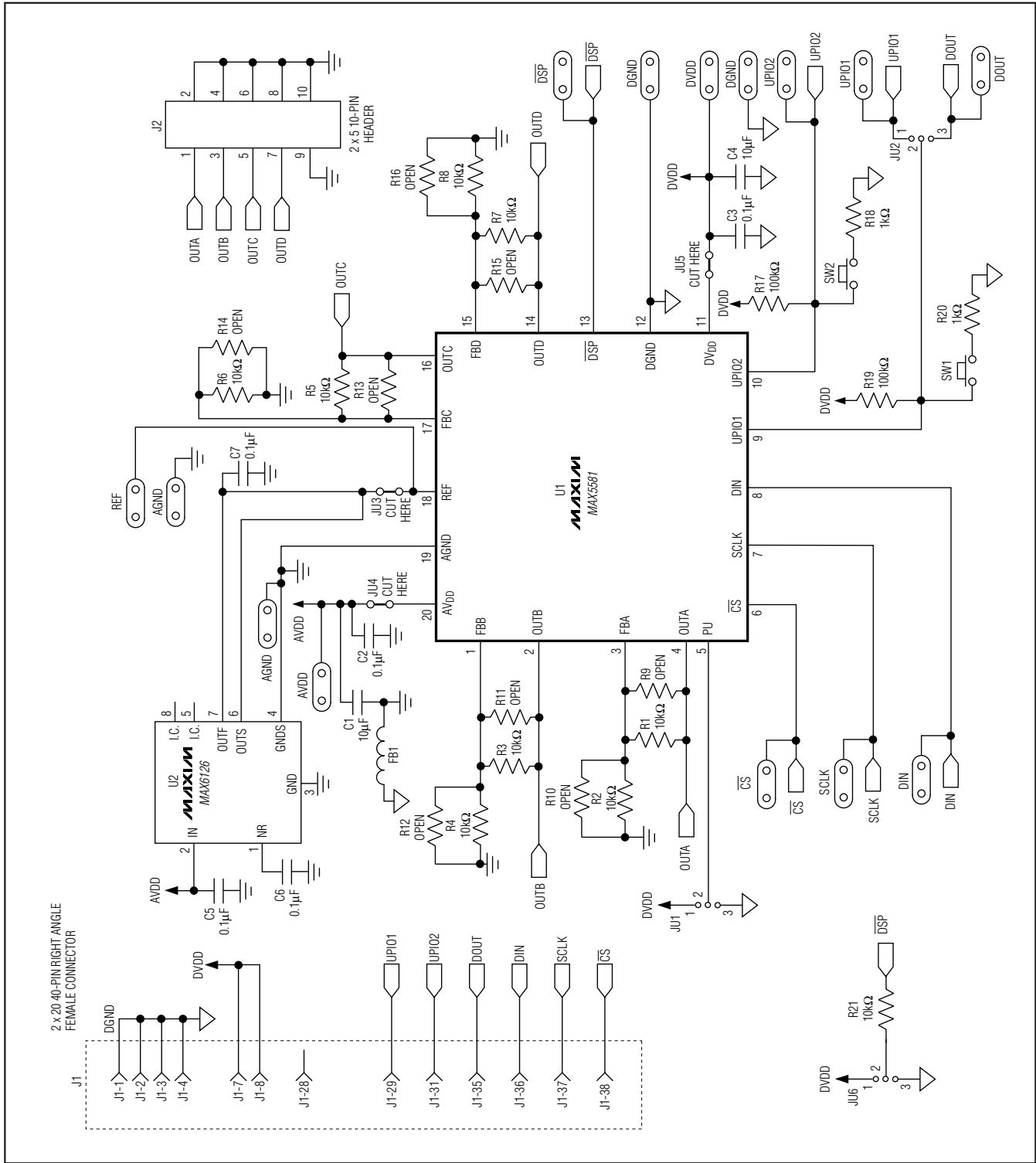

Figure 11. MAX5581 EV Kit Schematic

MAX5581 Evaluation Kit/Evaluation System

Evaluate: MAX5580-MAX5585

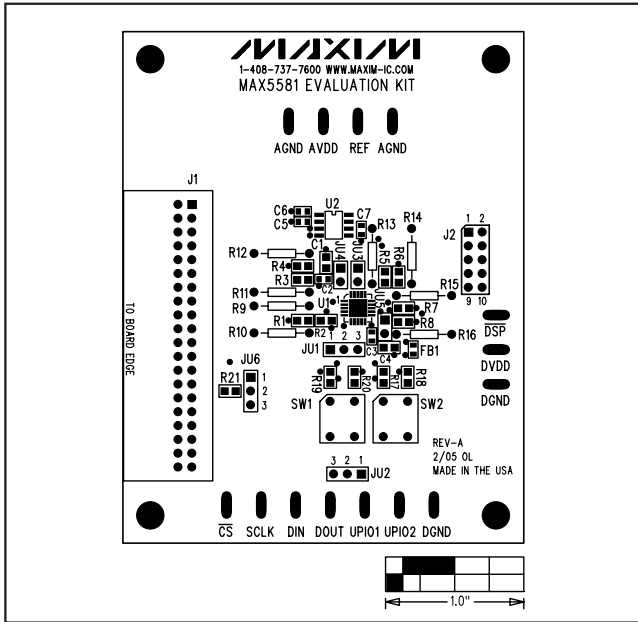

Figure 12. MAX5581 EV Kit Component Placement Guide—Component Side

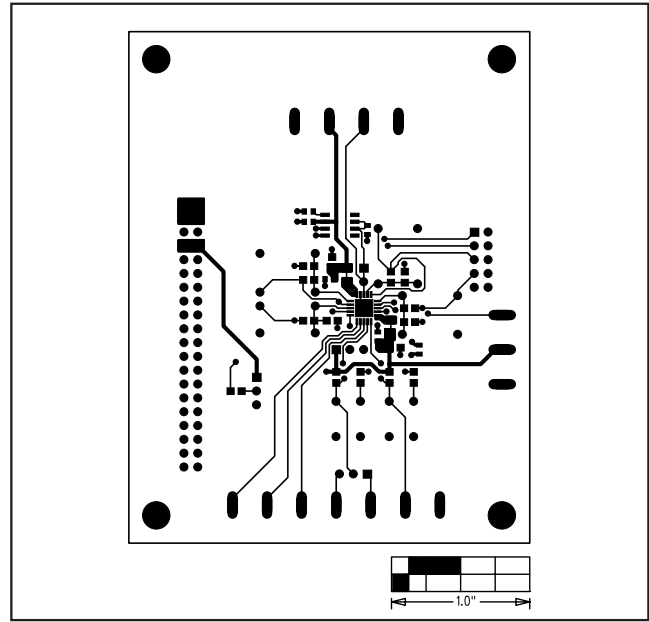

Figure 13. MAX5581 EV Kit PC Board Layout—Component Side

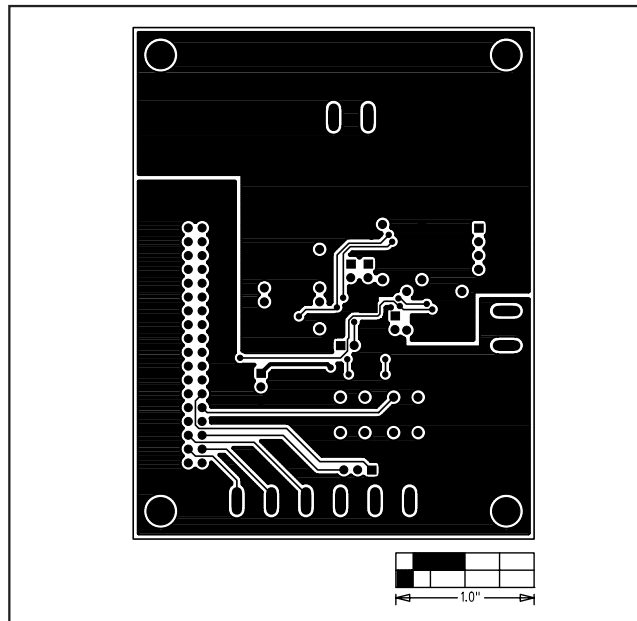

Figure 14. MAX5581 EV Kit PC Board Layout—Solder Side

Maxim cannot assume responsibility for use of any circuitry other than circuitry entirely embodied in a Maxim product. No circuit patent licenses are implied. Maxim reserves the right to change the circuitry and specifications without notice at any time.

Maxim Integrated Products, 120 San Gabriel Drive, Sunnyvale, CA 94086 408-737-7600 _____ 15