

Features

- Automotive Protection
- Glass Passivated Chip
- Excellent Clamping Capability
- Uni and Bidirectional Unit
- Halogen Free Available Upon Request By Adding Suffix "-HF"
- For Bidirectional Devices Add "C" To The Suffix of The Part Number: i.e.SLD10CA for 5% Tolerance
- Epoxy Meets UL 94 V-0 Flammability Rating
- Lead Free Finish/RoHS Compliant (Note1) ("P" Suffix Designates RoHS Compliant. See Ordering Information)

Maximum Ratings

- 6000 W Peak Pulse Power Capability With a 10/1000 us waveform Repetitive Rate(duty cycle)0.01%
- Operating Junction Temperature Range: -55°C to +175°C
- Storage Temperature Range: -55°C to +175°C

Peak Pulse Power Dissipation with a 10/1000µs Waveform	P_{PP}	6000W	Note 2
Peak Pulse Power Dissipation with a 10/10000µs Waveform	P_{PP}	2400W	Note 2
Power Dissipation On Infinite Heatsink	P_D	8.0W	$T_L=75^\circ\text{C}$
Peak forward surge current, 8.3 ms single half sine-wave unidirectional only	I_{FSM}	500A	Note 3
Maximum instantaneous forward voltage at 100 A for unidirectional only	V_F	3.5V	Note 3

Note:

- (1)High Temperature Solder Exemption Applied, see EU Directive Annex 7a.
- (2)Non-repetitive current pulse per Fig.3 and derated above $T_A=25^\circ\text{C}$ per Fig.4
- (3)Measured on 8.3 ms single half sine-wave or equivalent square wave, duty cycle = 4 pulses per minute maximum

Pin Configuration:

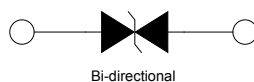
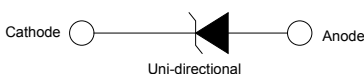

**6000Watts TVS
10 to 60 Volts**

R-6

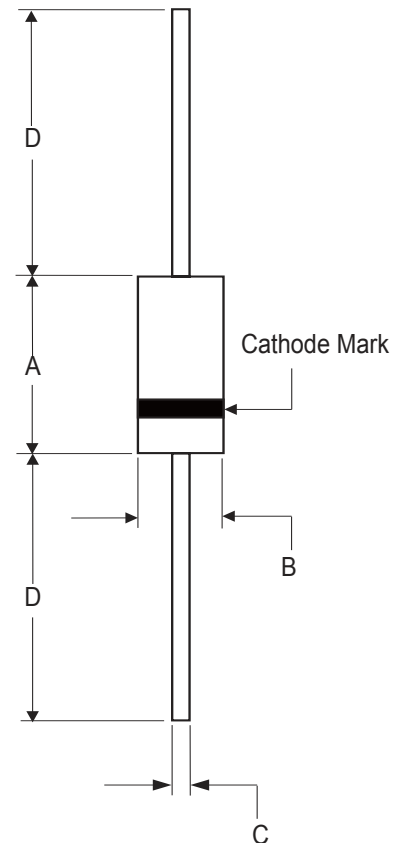

DIM	INCHES		MM		NOTE
	MIN	MAX	MIN	MAX	
A	0.340	0.360	8.60	9.10	
B	0.340	0.360	8.60	9.10	
C	0.048	0.052	1.20	1.32	
D	1.000	-----	25.40	-----	

Electrical Characteristics @ 25°C Unless Otherwise Specified

MCC Part Number		Breakdown Voltage V_{BR} @ I_T			Maximum Reverse Leakage $I_R @ V_{RWM}$ (μA)	Working Peak Reverse Voltage V_{RWM} (V)	Maximum Reverse Surge Current I_{PP} (A)	Maximum Clamping Voltage $V_C @ I_{PP}$ (V)
(Uni)	(Bi)	Min (V)	Max (V)	I_T (mA)				
SLD10A	SLD10CA	11.80	13.0	5	10	10	350.0	17.0
SLD11A	SLD11CA	12.20	13.5	5	10	11	327.0	18.2
SLD12A	SLD12CA	13.30	14.7	5	10	12	300.0	19.9
SLD13A	SLD13CA	14.40	15.9	5	10	13	277.0	21.5
SLD14A	SLD14CA	15.60	17.2	5	10	14	257.0	23.2
SLD15A	SLD15CA	16.70	18.5	5	10	15	245.0	24.4
SLD16A	SLD16CA	17.80	19.7	5	10	16	229.0	26.0
SLD17A	SLD17CA	18.90	20.9	5	10	17	216.0	27.6
SLD18A	SLD18CA	20.00	22.1	5	10	18	204.0	29.2
SLD20A	SLD20CA	22.20	24.5	5	10	20	184.0	32.4
SLD22A	SLD22CA	24.40	26.9	5	10	22	168.0	35.5
SLD24A	SLD24CA	25.00	30.0	5	10	24	153.0	38.9
SLD26A	SLD26CA	28.90	31.9	5	10	26	142.0	42.1
SLD28A	SLD28CA	31.10	34.4	5	10	28	131.0	45.4
SLD30A	SLD30CA	33.30	36.8	5	10	30	123.0	48.4
SLD33A	SLD33CA	36.70	40.6	5	10	33	112.0	53.3
SLD36A	SLD36CA	40.00	44.2	5	10	36	103.0	58.1
SLD40A	SLD40CA	44.40	49.1	5	10	40	92.5	64.5
SLD43A	SLD43CA	49.00	54.2	5	10	43	86.00	69.4
SLD48A	SLD48CA	53.30	58.9	5	10	48	77.00	77.4
SLD54A	SLD54CA	60.00	66.3	5	10	54	68.50	87.1
SLD58A	SLD58CA	64.40	71.2	5	10	58	64.00	93.6
SLD60A	SLD60CA	68.40	75.6	5	10	60	61.50	96.8

Note:

1. Add suffix ' CA ' after part number to specify Bi-directional devices
2. For Bi-Directional devices having V_R of 10 volts and under, the I_R limit is double
3. Surge current waveform is defined at 10/1000us waveform

Curve Characteristics

Fig. 1 - Peak Pulse Power Rating Curve

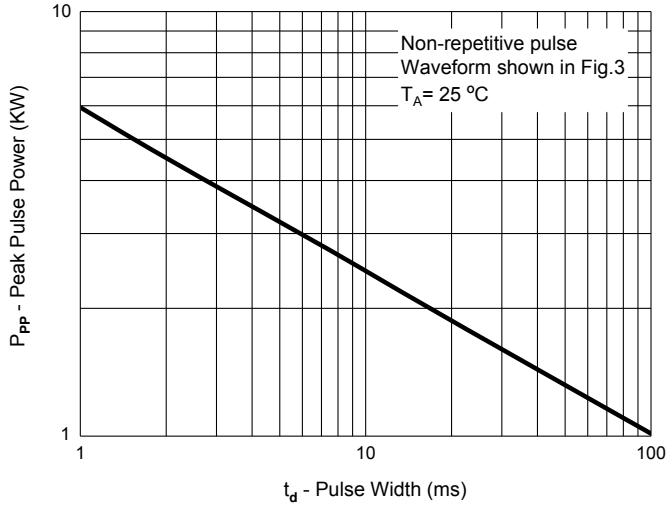

Fig. 2 - Typical Junction Capacitance

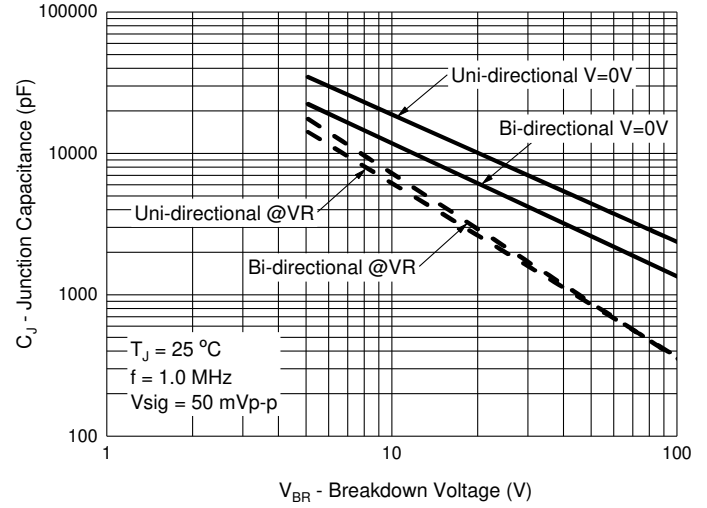

Fig. 3 - Pulse Waveform

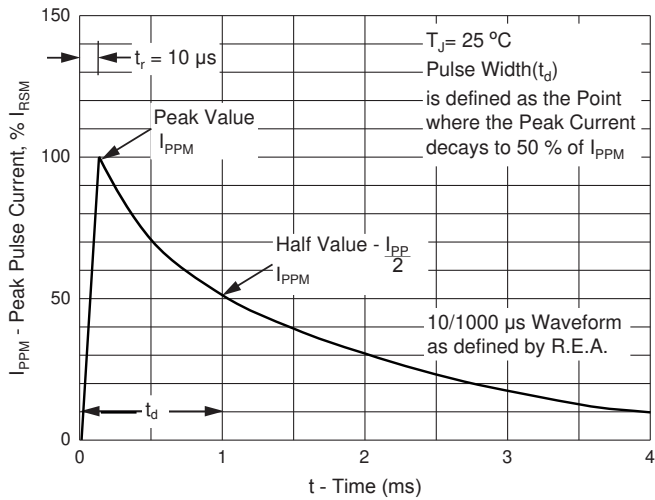
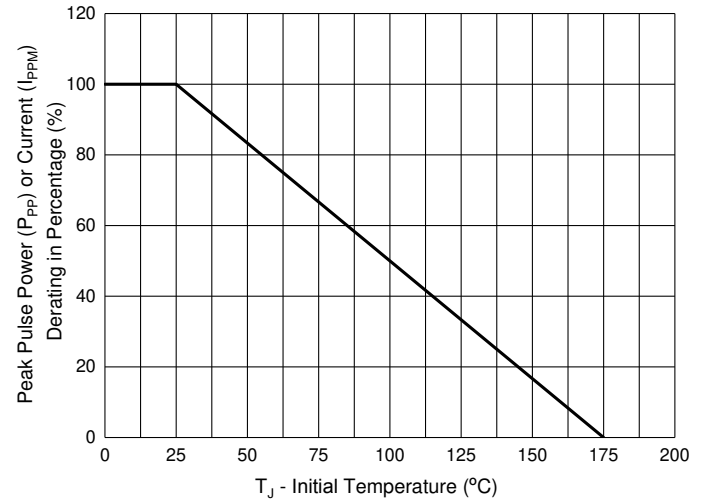

Fig. 4 - Pulse Derating Curve



Ordering Information

Device	Packing
(Part Number)-TP	Tape&Reel: 500pcs/Reel
(Part Number)-AP	Ammo Packing: 450pcs/Ammo Box
(Part Number)-BP	Bulk: 200pcs/Box ;4.8Kpcs/Carton

Note : Adding "-HF" Suffix For Halogen Free, eg. Part Number-TP-HF

IMPORTANT NOTICE

Micro Commercial Components Corp. reserves the right to make changes without further notice to any product herein to make corrections, modifications , enhancements , improvements , or other changes . **Micro Commercial Components Corp.** does not assume any liability arising out of the application or use of any product described herein; neither does it convey any license under its patent rights ,nor the rights of others . The user of products in such applications shall assume all risks of such use and will agree to hold **Micro Commercial Components Corp.** and all the companies whose products are represented on our website, harmless against all damages. **Micro Commercial Components Corp.** products are sold subject to the general terms and conditions of commercial sale, as published at <https://www.mccsemi.com/Home/TermsAndConditions>.

LIFE SUPPORT

MCC's products are not authorized for use as critical components in life support devices or systems without the express written approval of Micro Commercial Components Corporation.

CUSTOMER AWARENESS

Counterfeiting of semiconductor parts is a growing problem in the industry. Micro Commercial Components (MCC) is taking strong measures to protect ourselves and our customers from the proliferation of counterfeit parts. MCC strongly encourages customers to purchase MCC parts either directly from MCC or from Authorized MCC Distributors who are listed by country on our web page cited below. Products customers buy either from MCC directly or from Authorized MCC Distributors are genuine parts, have full traceability, meet MCC's quality standards for handling and storage. **MCC will not provide any warranty coverage or other assistance for parts bought from Unauthorized Sources.** MCC is committed to combat this global problem and encourage our customers to do their part in stopping this practice by buying direct or from authorized distributors.