

IN THE CONSTANT PURPOSE OF IMPROVING ITS PRODUCTS, AMPHENOL SOCAPEX RESERVES THE RIGHT TO MODIFY ANY DIMENSION OR CHARACTERISTICS.  
FM.NPD.0036.THYEZ.PUNE rev C

7,15±0,2 deviation X00  
5,5±0,2 deviation X04

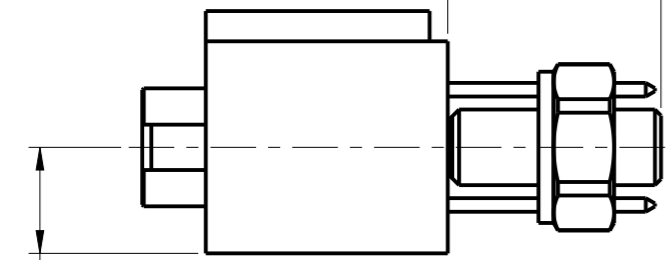

3,51 Max

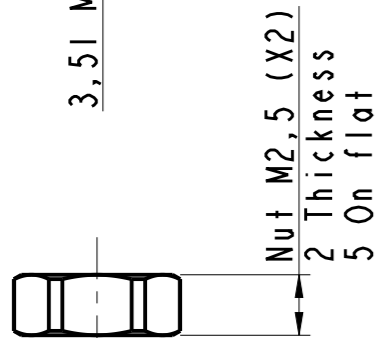

Ø0,45 Max  
(X50)

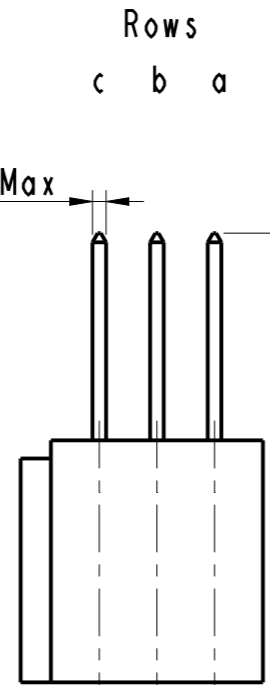

4,6±0,25 Type YDS  
6,8±0,25 Type YD

View without fittings

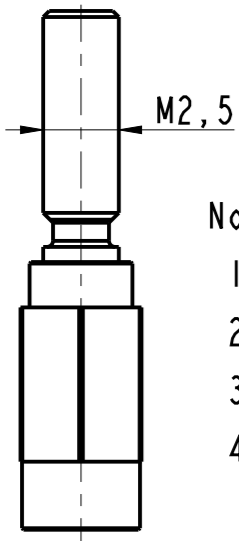

Section A-A

Notes:

- Part: HDAS E 050 YDX-X0X XXX
- External dimension of the recetpacle insulator with 50 signal contacts type YDX.
- Connector delivered with fittings not assembled, coupling torque : 0,25 Nm
- Standard 00X : Nickel plated over brass fittings.  
Deviation 10X : Passivated stainless steel fittings.

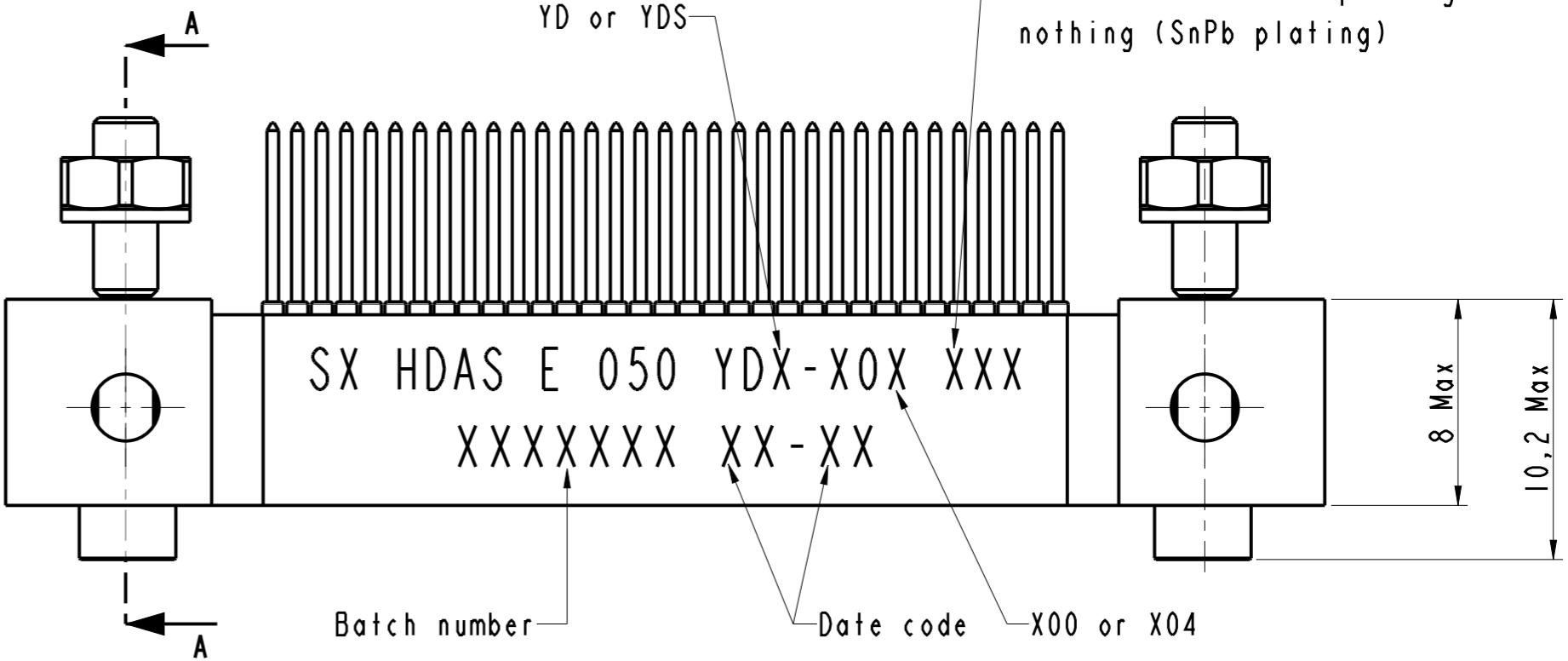
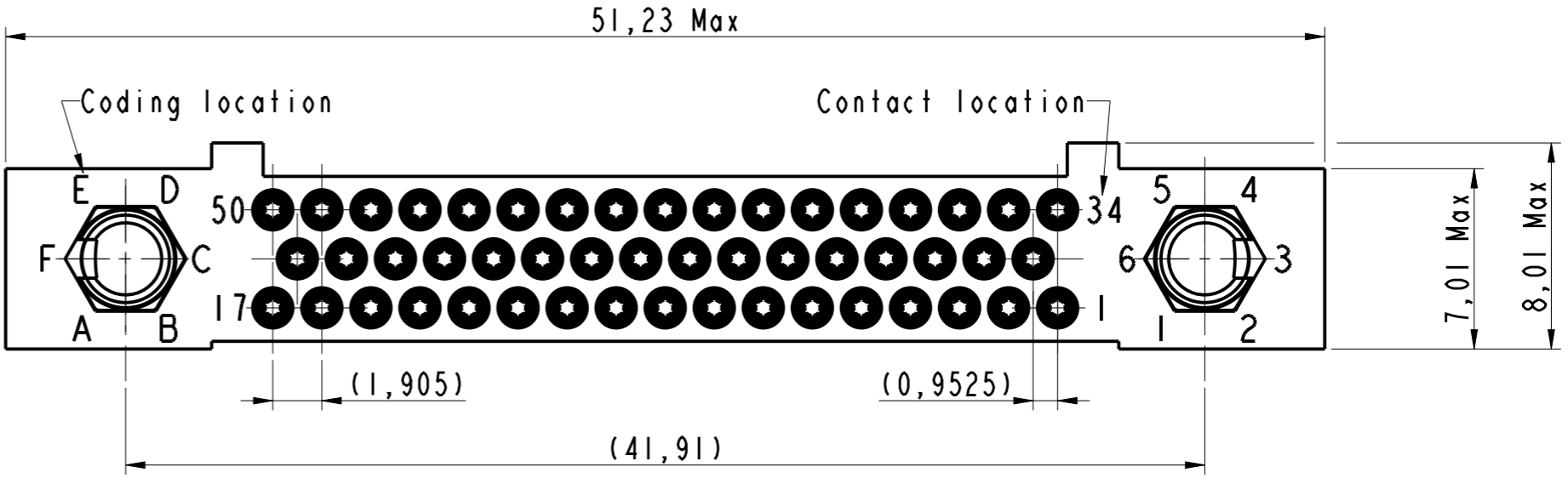

# HDAS E 050 YDX-X0X XXX

DRAWN BY : Botoma S		UPDATED BY : S Satpute		LAST APPROVED BY : T Carlier	
ALL DIMENSIONS ARE IN MM		AMPHENOL SOCAPEX		ORIGINAL DRAWING DATE : 06/02/2007	CONFIGURATION DATA ARE AVAILABLE IN PDM
SCALE : 4				REV : H	PAGE : 1/2
		B.P. 29 74311 THYEZ CEDEX		169-PLC-538-00	

PCB layout  
Face A

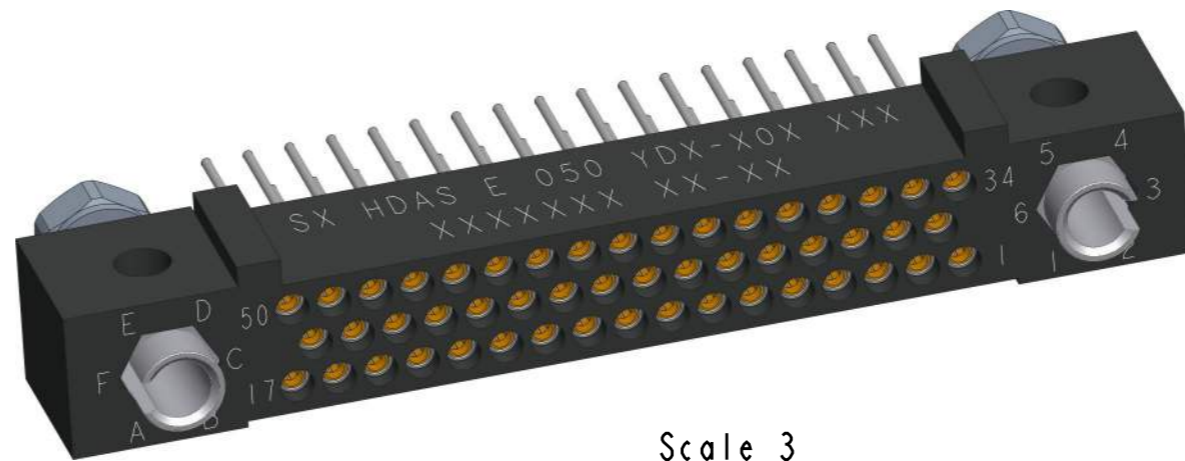
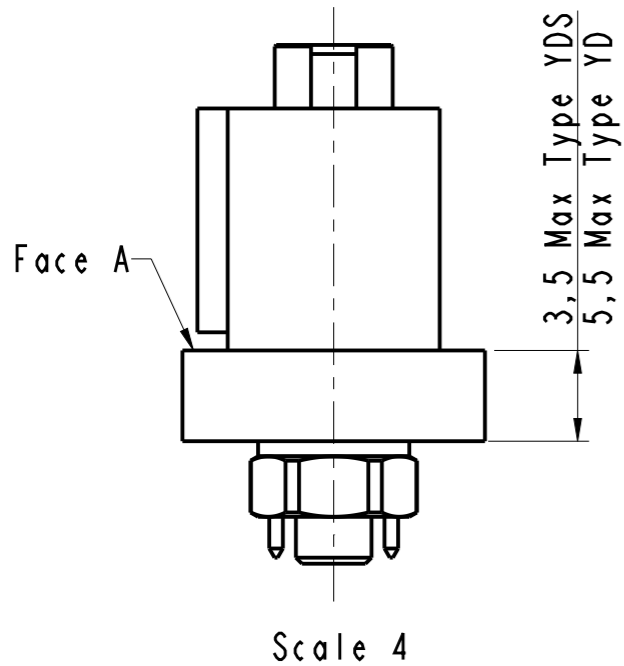
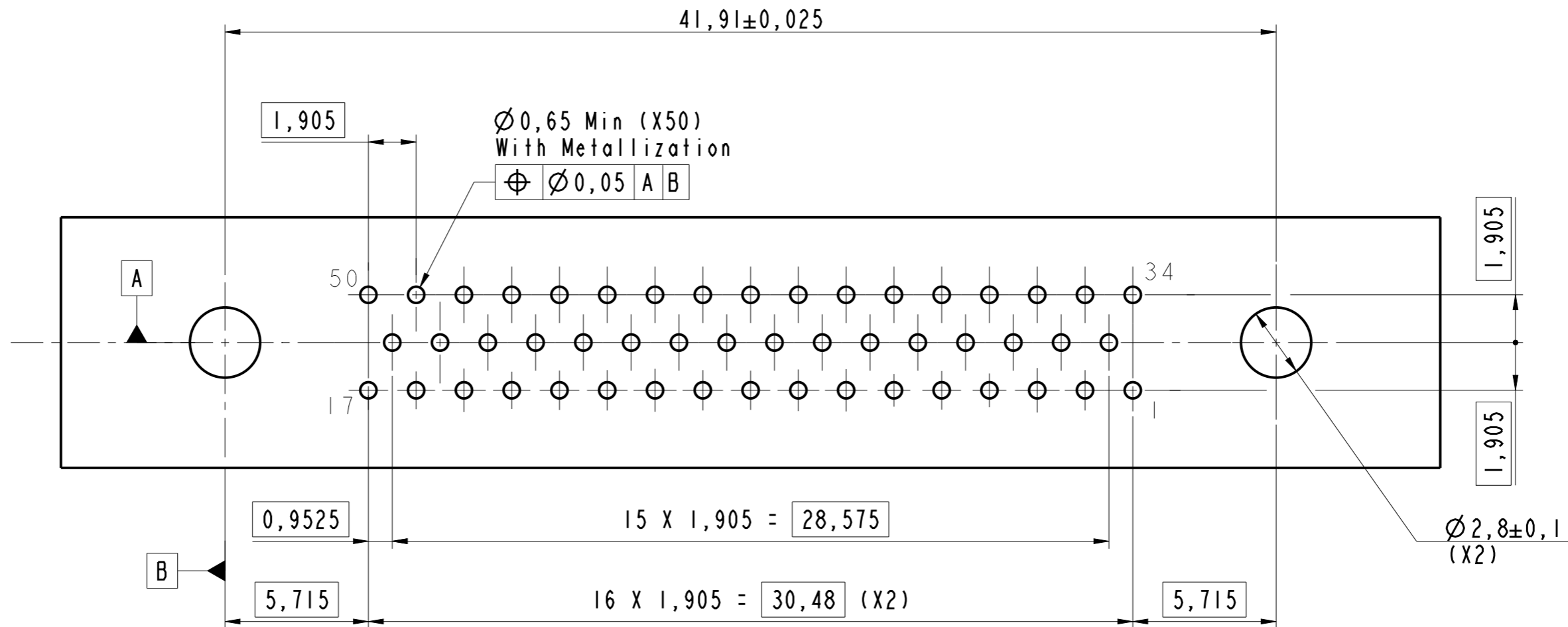

# HDAS E 050 YDX-X0X XXX

DRAWN BY : Botoma S		UPDATED BY : S Satpute		LAST APPROVED BY : T Carrier	
ALL DIMENSIONS ARE IN MM		AMPHENOL SOCAPEX		ORIGINAL DRAWING DATE : 06/02/2007	CONFIGURATION DATA ARE AVAILABLE IN PDM
SCALE : 5				REV : H	PAGE : 2/2
		B.P. 29 74311 THYEZ CEDEX		169-PLC-538-00	

IN THE CONSTANT PURPOSE OF IMPROVING ITS PRODUCTS, Amphenol Socapex reserves the right to modify any dimension or characteristics. FM.NPD.0036.THYEZ.PUNE rev C