

# FMS3810/3815

## Triple Video D/A Converters

### 3 x 8 bit, 150 Ms/s

#### Features

- 8-bit resolution
- 150 megapixels per second
  - 0.2% linearity error
- Sync and blank controls
- 1.0V p-p video into 37.5Ω or 75Ω load
- Internal bandgap voltage reference
- Double-buffered data for low distortion
- TTL-compatible inputs
- Low glitch energy
- Single +5 Volt power supply

#### Applications

- Video signal conversion
  - RGB
  - YCbCr
  - Composite, Y, C
- Multimedia systems
- Image processing
- True-color graphics systems

#### Description

FMS3810/3815 products are low-cost triple D/A converters that are tailored to fit graphics and video applications where speed is critical. Two speed grades are available:

FMS3810	100 Ms/s
FMS3815	150 Ms/s

TTL-level inputs are converted to analog current outputs that can drive 25–37.5Ω loads corresponding to doubly-terminated 50–75Ω loads. A sync current following SYNC input timing is added to the IOG output. BLANK will override RGB inputs, setting IOG, IOB and IOR currents to zero when  $\overline{\text{BLANK}} = \text{L}$ . Although appropriate for many applications the internal 1.235V reference voltage can be overridden by the VREF input.

Few external components are required, just the current reference resistor, current output load resistors, and decoupling capacitors.

Package is a 48-lead LQFP. Fabrication technology is CMOS. Performance is guaranteed from 0 to 70°C.

#### Block Diagram

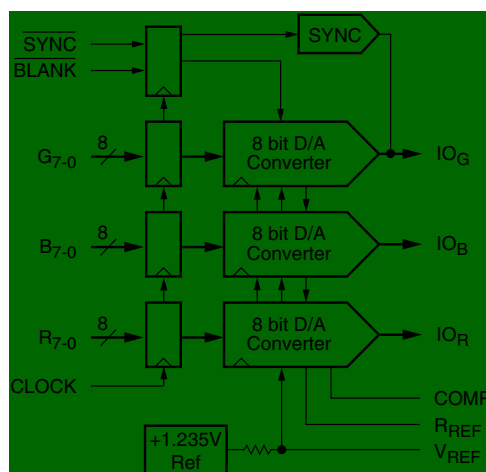

## Functional Description

Within the FMS3810/3815 are three identical 10-bit D/A converters, each with a current source output. External loads are required to convert the current to voltage outputs. Data inputs RGB7-0 are overridden by the  $\overline{\text{BLANK}}$  input.  $\overline{\text{SYNC}} = \text{H}$  activates, sync current from IOS for sync-on-green video signals.

### Digital Inputs

All digital inputs are TTL-compatible. Data is registered on the rising edge of the CLK signal. Following one stage of pipeline delay, the analog output changes tDO after the rising edge of CLK.

### $\overline{\text{SYNC}}$ and $\overline{\text{BLANK}}$

$\overline{\text{SYNC}}$  and  $\overline{\text{BLANK}}$  inputs control the output level (Figure 1 and Table 1) of the D/A converters during CRT retrace intervals.  $\overline{\text{BLANK}}$  forces the D/A outputs to the blanking level while  $\overline{\text{SYNC}} = \text{L}$  turns off a current source that is connected to the green D/A converter.  $\overline{\text{SYNC}} = \text{H}$  adds a 40 IRE sync pulse to the green output,  $\overline{\text{SYNC}} = \text{L}$  sets the green output to 0.0 Volts during the sync tip.  $\overline{\text{SYNC}}$  and  $\overline{\text{BLANK}}$  are registered on the rising edge of CLK.



Figure 1. Nominal Output Levels

$\overline{\text{BLANK}}$  gates the D/A inputs and sets the pedestal voltage. If  $\overline{\text{BLANK}} = \text{H}$ , the D/A inputs are added to a pedestal which offsets the current output. If  $\overline{\text{BLANK}} = \text{L}$ , data inputs and the pedestal are disabled.

### D/A Outputs

Each D/A output is a current source. To obtain a voltage output, a resistor must be connected to ground. Output voltage depends upon this external resistor, the reference voltage, and the value of the gain-setting resistor connected between RREF and GND.

Normally, a source termination resistor of 75 Ohms is connected between the D/A current output pin and GND near the D/A converter. A 75 Ohm line may then be connected with another 75 Ohm termination resistor at the far end of the cable. This “double termination” presents the D/A converter with a net resistive load of 37.5 Ohms.

The FMS3810/3815 may also be operated with a single 75 Ohm terminating resistor. To lower the output voltage swing to the desired range, the nominal value of the resistor on RREF should be doubled.

### Voltage Reference

All three D/A converters are supplied with a common voltage reference. Internal bandgap voltage reference voltage is +1.235 Volts with a 3K $\Omega$  source resistance. An external voltage reference may be connected to the VREF pin, overriding the internal voltage reference.

A 0.1 $\mu\text{F}$  capacitor must be connected between the COMP pin and VDD to stabilize internal bias circuitry and ensure low-noise operation.

### Power and Ground

Required power is a single +5.0 Volt supply. To minimize power supply induced noise, analog +5V should be connected to VDD pins with 0.1 and 0.01  $\mu\text{F}$  decoupling capacitors placed adjacent to each VDD pin or pin pair.

High slew-rate of digital data makes capacitive coupling to the outputs of any D/A converter a potential problem. Since the digital signals contain high-frequency components of the CLK signal, as well as the video output signal, the resulting data feedthrough often looks like harmonic distortion or reduced signal-to-noise performance. All ground pins should be connected to a common solid ground plane for best performance.

**Table 1. Output Voltage versus Input Code, SYNC and BLANK**

V<sub>REF</sub> = 1.235 V, R<sub>REF</sub> = 590 Ω, R<sub>L</sub> = 37.5 Ω

RGB7-0 (MSB...LSB)	Blue and Red			Green		
	SYNC	BLANK	V <sub>OUT</sub>	SYNC	BLANK	V <sub>OUT</sub>
1111 1111	X	1	0.714	1	1	1.000
1111 1111	X	1	0.714	0	1	0.714
1111 1110	X	1	0.711	1	1	0.997
1111 1101	X	1	0.709	1	1	0.995
•	•	•	•	•	•	•
•	•	•	•	•	•	•
0000 0000	X	1	0.385	1	1	0.671
1111 1111	X	1	0.383	1	1	0.669
•	•	•	•	•	•	•
•	•	•	•	•	•	•
0000 0010	X	1	0.059	1	1	0.345
0000 0001	X	1	0.057	1	1	0.343
0000 0000	X	1	0.054	1	1	0.340
0000 0000	X	1	0.054	0	1	0.054
XXXX XXXX	X	0	0.000	1	0	0.286
XXXX XXXX	X	0	0.000	0	0	0.000
XXXX XXXX	X	1	valid	0	1	valid

**Pin Assignments**

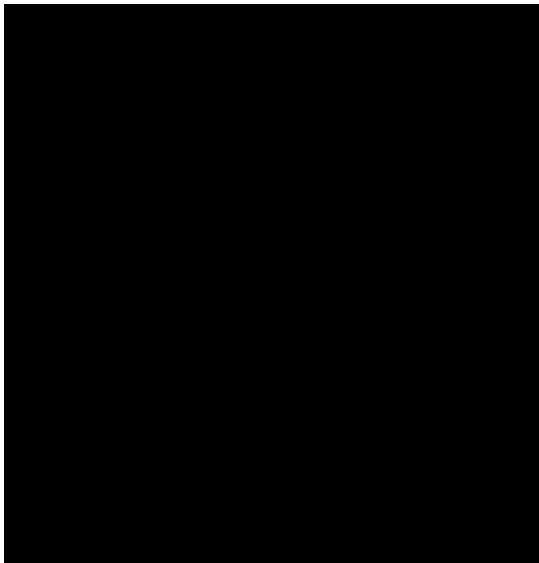

## Pin Descriptions

Pin Name	Pin Number	Value	Pin Function Description
	LQFP		
<b>Clock and Pixel I/O</b>			
CLK	26	TTL	<b>Clock Input.</b> The clock input is TTL-compatible and all pixel data is registered on the rising edge of CLK. It is recommended that CLK be driven by a dedicated TTL buffer to avoid reflection induced jitter, overshoot, and undershoot.
R7-0 G7-0 B7-0	47-40 9-2 23-16	TTL	<b>Red, Green, and Blue Pixel Inputs.</b> TTL-compatible RGB digital inputs are registered on the rising edge of CLK.
<b>Controls</b>			
SYNC	11	TTL	<b>Sync Pulse Input.</b> Bringing $\overline{\text{SYNC}}$ LOW, turns off a 40 IRE (7.62 mA) current source which forms a sync pulse on any D/A converter output connected to IOs. $\overline{\text{SYNC}}$ is registered on the rising edge of CLK along with pixel data and has the same pipeline latency as $\overline{\text{BLANK}}$ and pixel data. SYNC does not override any other data and should be used only during the blanking interval. If the system does not require sync pulses, $\overline{\text{SYNC}}$ and IOs should be connected to GND.
$\overline{\text{BLANK}}$	10	TTL	<b>Blanking Input.</b> When $\overline{\text{BLANK}}$ is LOW, pixel inputs are ignored and the D/A converter outputs are driven to the blanking level. $\overline{\text{BLANK}}$ is registered on the rising edge of CLK and has the same two-pipe latency as SYNC and Data.
<b>Video Outputs</b>			
IOR IOG IOB	33 32 29	0.714 V <sub>p-p</sub>	<b>Red, Green, and Blue Current Outputs.</b> Current source outputs can drive RS-343A/SMPTE-170M compatible levels into doubly-terminated 75 Ohm lines. Sync pulses may be added to the green output. When SYNC is HIGH, the current added to IOG is:  $\text{IO}_S = 3.64 (V_{\text{REF}} / R_{\text{REF}})$
<b>Voltage Reference</b>			
VREF	35	+1.235 V	<b>Voltage Reference Input/Output.</b> Internal 1.235V voltage reference is available on this pin. An external +1.235 Volt reference may be applied to this pin to override the internal reference. Decoupling VREF to GND with a 0.1 $\mu\text{F}$ ceramic capacitor is required.
RREF	36	590 $\Omega$	<b>Current-setting Resistor.</b> Full-scale output current of each D/A converter is determined by the value of the resistor connected between RREF and GND. Nominal value of RREF is found from:  $R_{\text{REF}} = 9.1 (V_{\text{REF}} / I_{\text{FS}})$ where IFS is the full-scale (white) output current (amps) from the D/A converter (without sync). Sync is 0.4 IFS.  D/A full-scale (white) current may also be calculated from:  $I_{\text{FS}} = V_{\text{FS}} / R_{\text{L}}$ Where VFS is the white voltage level and RL is the total resistive load (ohms) on each D/A converter. VFS is the blank to full-scale voltage.
COMP	34	0.1 $\mu\text{F}$	<b>Compensation Capacitor.</b> A 0.1 $\mu\text{F}$ ceramic capacitor should be connected between COMP and VDD to stabilize internal bias circuitry.

**Pin Descriptions** (continued)

Pin Name	Pin Number	Value	Pin Function Description
	LQFP		
<b>Power, Ground</b>			
VDD	12, 30, 31	+5 V	<b>Power Supply.</b>
GND	1, 14, 15, 27, 28, 38, 39, 48	0.0V	<b>Ground.</b>
NC	13, 24, 25, 37	—	<b>No Connect</b>

**Equivalent Circuits**

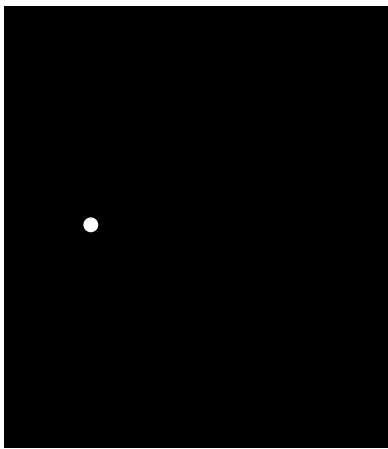

Figure 1. Equivalent Digital Input Circuit

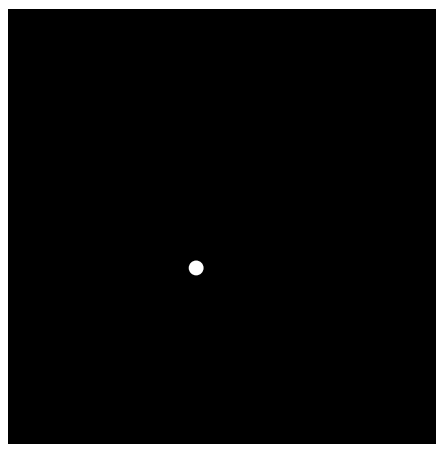

Figure 2. Equivalent Analog Output Circuit

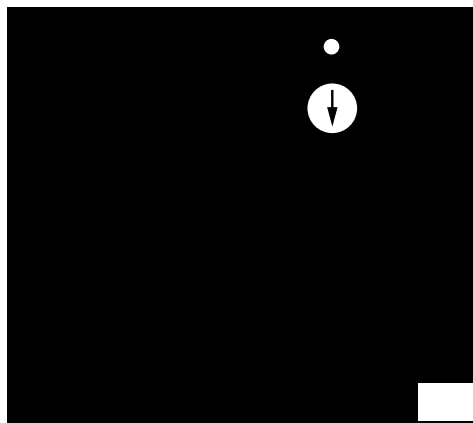

Figure 3. Equivalent Analog Input Circuit

**Absolute Maximum Ratings** (beyond which the device may be damaged)<sup>1</sup>

Parameter	Min	Typ	Max	Unit
<b>Power Supply Voltage</b>				
VDD (Measured to GND)	-0.5		7.0	V
<b>Inputs</b>				
Applied Voltage (measured to GND) <sup>2</sup>	-0.5		VDD + 0.5	V
Forced Current <sup>3,4</sup>	-10.0		10.0	mA
<b>Outputs</b>				
Applied Voltage (measured to GND) <sup>2</sup>	-0.5		VDD + 0.5	V
Forced Current <sup>3,4</sup>	-60.0		60.0	mA
Short Circuit Duration (single output in HIGH state to ground)			unlimited	sec.
<b>Temperature</b>				
Operating, Ambient	-20		110	°C
Junction			150	°C
Lead Soldering (10 seconds)			300	°C
Vapor Phase Soldering (1 minute)			220	°C
Storage	-65		150	°C

**Notes:**

1. Functional operation under any of these conditions is NOT implied. Performance and reliability are guaranteed only if Operating Conditions are not exceeded.
2. Applied voltage must be current limited to specified range.
3. Forcing voltage must be limited to specified range.
4. Current is specified as conventional current flowing into the device.

**Operating Conditions**

Parameter	Min	Nom	Max	Units		
VDD	Power Supply Voltage		4.75	5.0	5.25	V
fs	Conversion Rate	FMS3810			100	Msp/s
		FMS3815			150	Msp/s
tpWH	CLK Pulsewidth, HIGH	FMS3810	3.1			ns
		FMS3815	2.5			ns
tpWL	CLK Pulsewidth, LOW	FMS3810	3.1			ns
		FMS3815	2.5			ns
tw	CLK Pulsewidth	FMS3810	10			ns
		FMS3815	6.6			ns
ts	Input Data Setup Time		1.7			ns
th	Input Date Hold Time		0			ns
VREF	Reference Voltage, External		1.0	1.235	1.5	V
CC	Compensation Capacitor			0.1		μF
RL	Output Load			37.5		Ω
VIH	Input Voltage, Logic HIGH		2.0		VDD	V
VIL	Input Voltage, Logic LOW		GND		0.8	V
TA	Ambient Temperature, Still Air		0		70	°C

## Electrical Characteristics

Parameter		Conditions <sup>3</sup>	Min	Typ <sup>1</sup>	Max	Units
I <sub>DD</sub>	Power Supply Current <sup>2</sup>	V <sub>DD</sub> = Max			125	mA
PD	Total Power Dissipation <sup>2</sup>	V <sub>DD</sub> = Max			655	mW
R <sub>O</sub>	Output Resistance			100		kΩ
C <sub>O</sub>	Output Capacitance	I <sub>OUT</sub> = 0mA			30	pF
I <sub>IH</sub>	Input Current, HIGH	V <sub>DD</sub> = Max, V <sub>IN</sub> = 2.4V			-5	μA
I <sub>IL</sub>	Input Current, LOW	V <sub>DD</sub> = Max, V <sub>IN</sub> = 0.4V			5	μA
I <sub>REF</sub>	V <sub>REF</sub> Input Bias Current			0	±100	μA
V <sub>REF</sub>	Reference Voltage Output			1.235		V
V <sub>OC</sub>	Output Compliance	Referred to V <sub>DD</sub>	-0.4	0	+1.5	V
C <sub>DI</sub>	Digital Input Capacitance			4	10	pF

### Notes:

1. Values shown in Typ column are typical for V<sub>DD</sub> = +5V and T<sub>A</sub> = 25°C
2. Minimum/Maximum values with V<sub>DD</sub> = Max and T<sub>A</sub> = Min
3. V<sub>REF</sub> = 1.235V, R<sub>LOAD</sub> = 37.5Ω, R<sub>REF</sub> = 590Ω

## Switching Characteristics

Parameter		Conditions <sup>2</sup>	Min	Typ <sup>1</sup>	Max	Units
t <sub>D</sub>	Clock to Output Delay	V <sub>DD</sub> = Min		10	15	ns
t <sub>SKEW</sub>	Output Skew			1	2	ns
t <sub>R</sub>	Output Risetime	10% to 90% of Full Scale			3	ns
t <sub>F</sub>	Output Falltime	90% to 10% of Full Scale			3	ns

### Notes:

1. Values shown in Typ column are typical for V<sub>DD</sub> = +5V and T<sub>A</sub> = 25°C.
2. V<sub>REF</sub> = 1.235V, R<sub>LOAD</sub> = 37.5Ω, R<sub>REF</sub> = 590Ω.

## System Performance Characteristics

Parameter		Conditions <sup>2</sup>	Min	Typ <sup>1</sup>	Max	Units
ELI	Integral Linearity Error	V <sub>DD</sub> , V <sub>REF</sub> = Nom		±0.2	±0.3	%/FS
ELD	Differential Linearity Error	V <sub>DD</sub> , V <sub>REF</sub> = Nom		±0.2	±0.3	%/FS
EDM	DAC to DAC Matching	V <sub>DD</sub> , V <sub>REF</sub> = Nom		5	10	%
PSRR	Power Supply Rejection Ratio				0.05	%/%

### Notes:

1. Values shown in Typ column are typical for V<sub>DD</sub> = +5V and T<sub>A</sub> = 25°C.
2. V<sub>REF</sub> = 1.235V, R<sub>LOAD</sub> = 37.5Ω, R<sub>REF</sub> = 590Ω.

## Timing Diagram

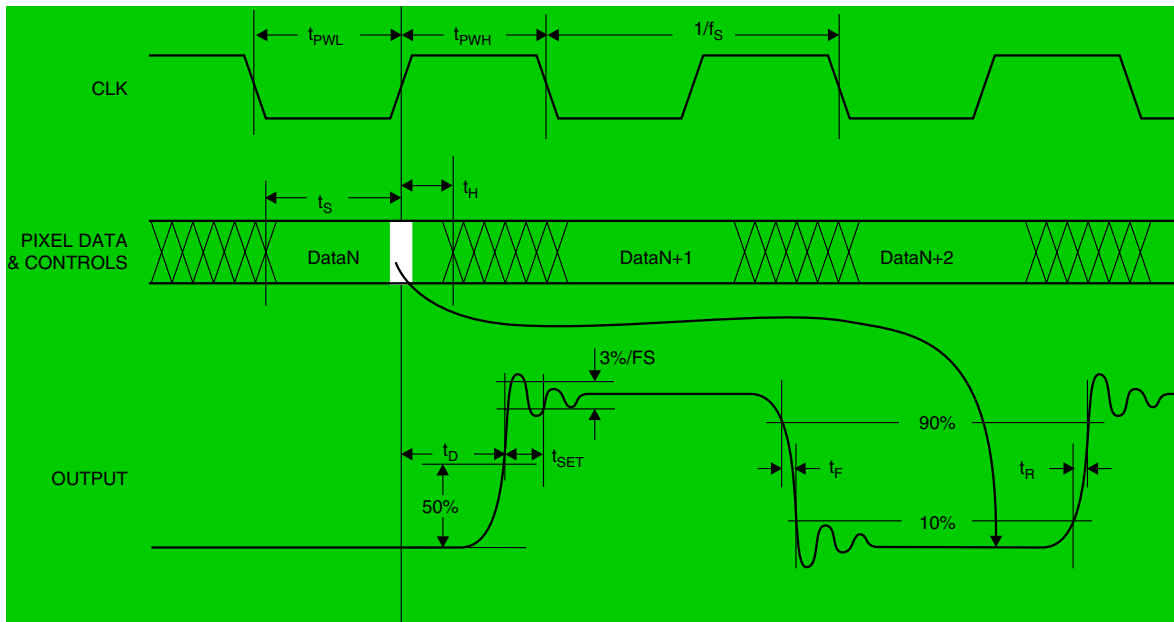

## Applications Information

Figure 4 illustrates a typical FMS3810/3815 interface circuit. In this example, an optional 1.2 Volt bandgap reference is connected to the VREF output, overriding the internal voltage reference source.

### Grounding

It is important that the FMS3810/3815 power supply is well-regulated and free of high-frequency noise. Careful power supply decoupling will ensure the highest quality video signals at the output of the circuit. The FMS3810/3815 has separate analog and digital circuits. To keep digital system noise from the D/A converter, it is recommended that power supply voltages (VDD) come from the system analog power source and all ground connections (GND) be made to the analog ground plane. Power supply pins should be individually decoupled at the pin.

### Printed Circuit Board Layout

Designing with high-performance mixed-signal circuits demands printed circuits with ground planes. Overall system performance is strongly influenced by the board layout. Capacitive coupling from digital to analog circuits may result in poor D/A conversion. Consider the following suggestions when doing the layout:

1. Keep the critical analog traces (VREF, IREF, COMP, IOS, IOR, IOG) as short as possible and as far as possible from all digital signals. The FMS3810/3815 should be located near the board edge, close to the analog output connectors.
2. The power plane for the FMS3810/3815 should be separate from that which supplies the digital circuitry. A single power plane should be used for all of the VDD pins. If the power supply for the FMS3810/3815 is the same as that of the system's digital circuitry, power to the FMS3810/3815 should be decoupled with 0.1 $\mu$ F and 0.01 $\mu$ F capacitors and isolated with a ferrite bead.
3. The ground plane should be solid, not cross-hatched. Connections to the ground plane should have very short leads.
4. If the digital power supply has a dedicated power plane layer, it should not be placed under the FMS3810/3815, the voltage reference, or the analog outputs. Capacitive coupling of digital power supply noise from this layer to the FMS3810/3815 and its related analog circuitry can have an adverse effect on performance.
5. CLK should be handled carefully. Jitter and noise on this clock will degrade performance. Terminate the clock line carefully to eliminate overshoot and ringing.



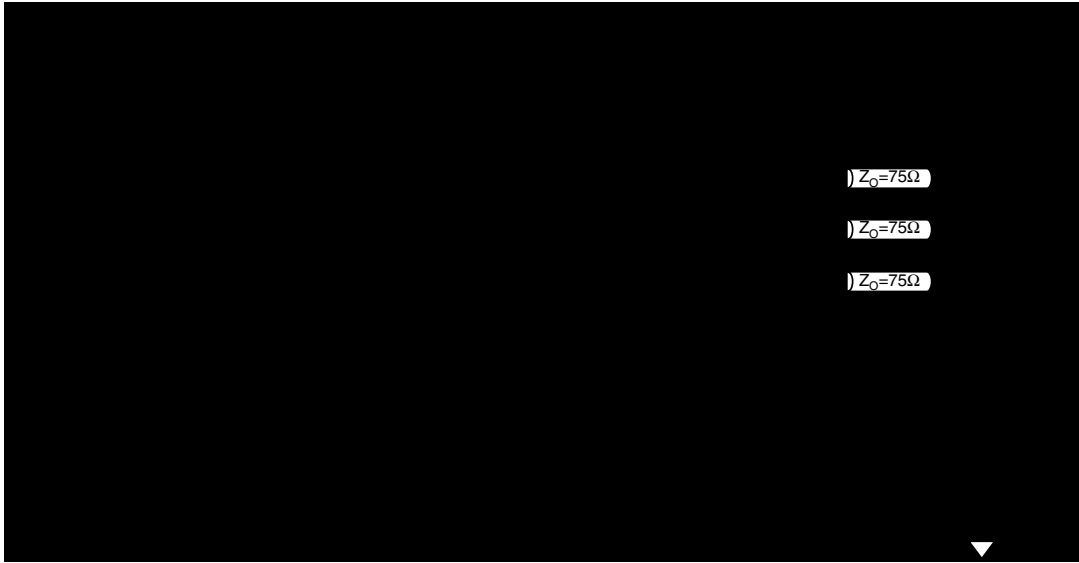

Figure 4. Typical Interface Circuit

## Related Products

- FMS3110/3115 Triple 10-bit 250 Msps D/A Converters
- FMS9884A 3 x 8 bit 140 Ms/s A/D Converter

## Mechanical Dimensions

### 48-Lead LQFP Package

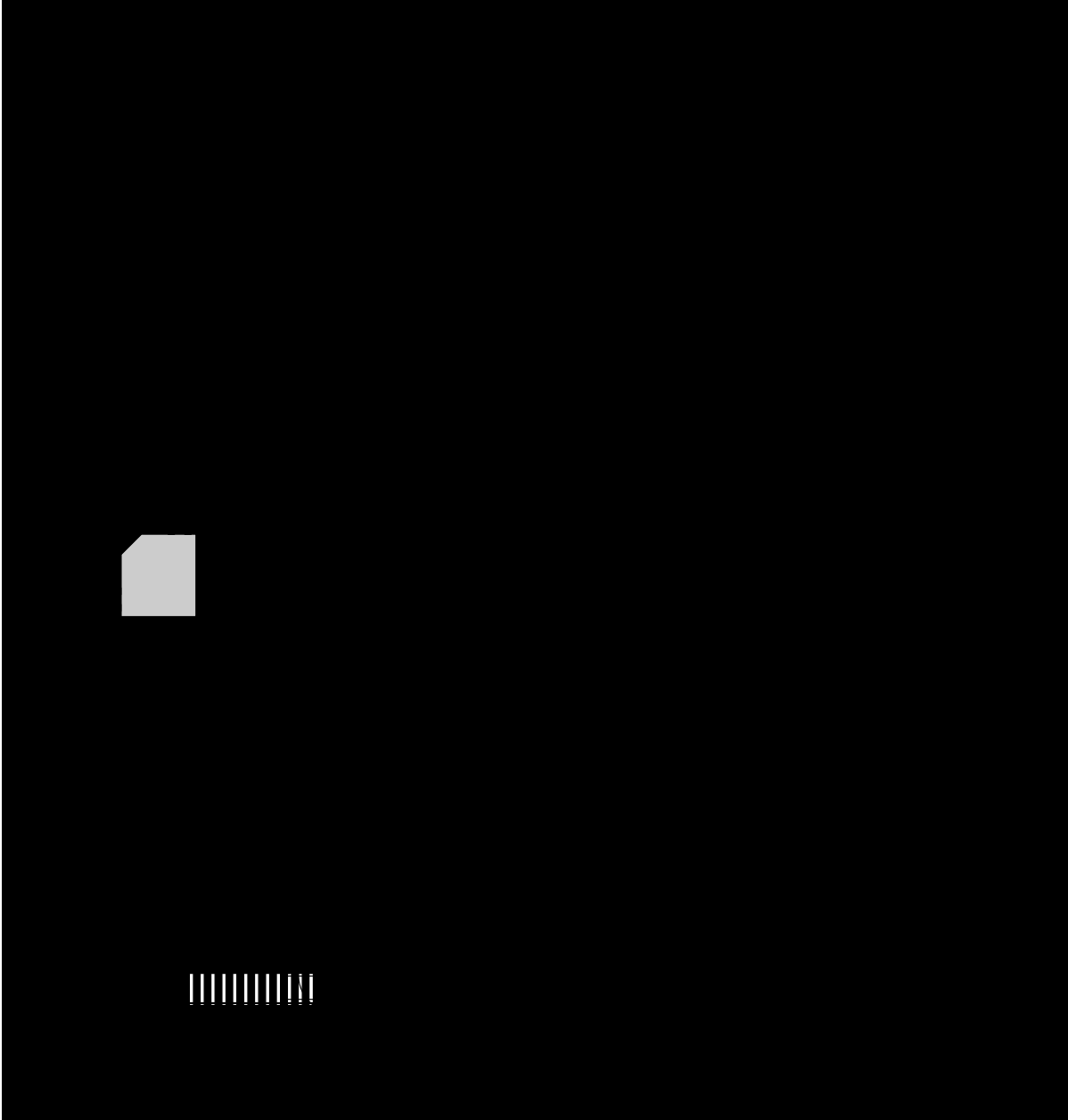

## Ordering Information

Product Number	Conversion Rate	Temperature Range	Screening	Package	Package Marking
FMS3810KRC	100 Ms/s	T <sub>A</sub> = 0°C to 70°C	Commercial	48-Lead LQFP	3810KRC
FMS3815KRC	150 Ms/s	T <sub>A</sub> = 0°C to 70°C	Commercial	48-Lead LQFP	3815KRC

### DISCLAIMER

FAIRCHILD SEMICONDUCTOR RESERVES THE RIGHT TO MAKE CHANGES WITHOUT FURTHER NOTICE TO ANY PRODUCTS HEREIN TO IMPROVE RELIABILITY, FUNCTION OR DESIGN. FAIRCHILD DOES NOT ASSUME ANY LIABILITY ARISING OUT OF THE APPLICATION OR USE OF ANY PRODUCT OR CIRCUIT DESCRIBED HEREIN; NEITHER DOES IT CONVEY ANY LICENSE UNDER ITS PATENT RIGHTS, NOR THE RIGHTS OF OTHERS.

### LIFE SUPPORT POLICY

FAIRCHILD'S PRODUCTS ARE NOT AUTHORIZED FOR USE AS CRITICAL COMPONENTS IN LIFE SUPPORT DEVICES OR SYSTEMS WITHOUT THE EXPRESS WRITTEN APPROVAL OF THE PRESIDENT OF FAIRCHILD SEMICONDUCTOR CORPORATION. As used herein:

1. Life support devices or systems are devices or systems which, (a) are intended for surgical implant into the body, or (b) support or sustain life, and (c) whose failure to perform when properly used in accordance with instructions for use provided in the labeling, can be reasonably expected to result in a significant injury of the user.
2. A critical component in any component of a life support device or system whose failure to perform can be reasonably expected to cause the failure of the life support device or system, or to affect its safety or effectiveness.