

REV. Status
 PRELIMINARY
 11/02/00 BT

PRELIMINARY 1
 DELETED DCR
 ON PG. 1, &
 ADDED PAD
 LAYOUT ON
 PG. 2.
 11/27/00 LL



Gigabit Ethernet, 1000 Base-T 24 pin SOIC

- Supports 4 pairs of Category UTP5 cable
- Complies with IEEE 802.3ab Standard
- Surface Mount Device withstands IR reflow profile process
- Operating temperature: 0°C to 70°C
- Enhanced Common Mode Attenuation

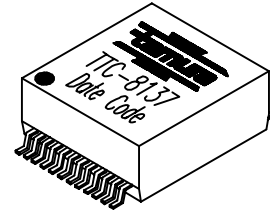

MODEL NUMBER
TTC-8137

PRELIMINARY

Electrical Specification @ 25°C

Insertion Loss (dB Max)	Return Loss (dB Min)			Differential Mode Rejection Ratio (dB Min)	Common Mode Rejection Ratio (dB Min)	Leakage Inductance (μH Max)	Crosstalk (dB Min)	OCL (μH Min)	Hipot (Vrms)
	1-100 MHz	0.1-30 MHz	60-80 MHz						
-1	-18	-12	-10	-33	-30	0.5	-35	350	1500

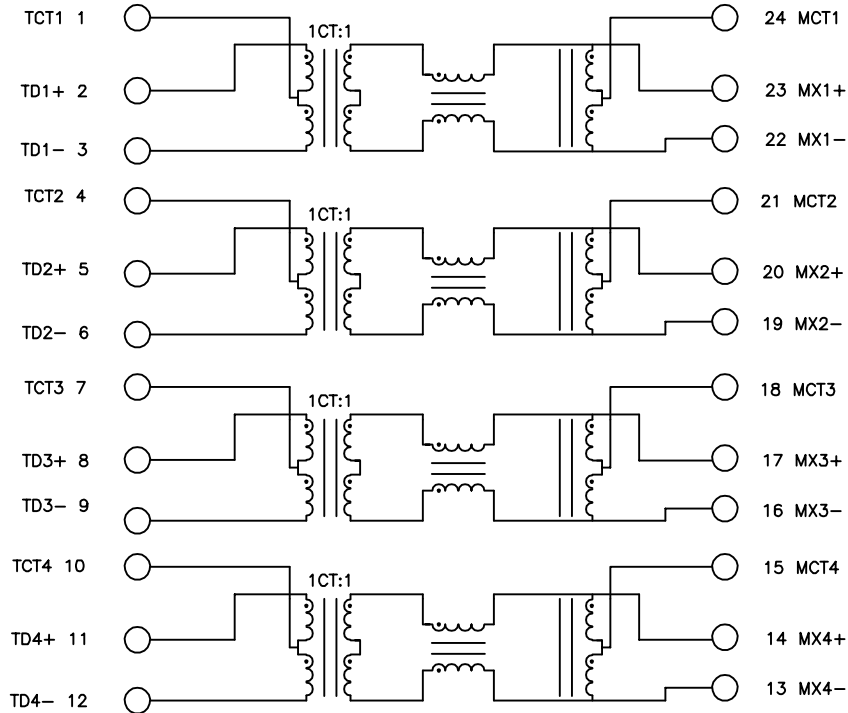

PREPARED BY:

D. Rund

ENGINEER:

L. Le

QUALITY CONTROL:

D. Kelley

APPROVED:

J. Coleman

DWG CONTROL NO.
 P-A1-12640
 ACAD\TTC\A1126401.DWG

REV
PR1

GIGABIT ETHERNET, 1000 BASE-T
 24 PIN SOIC

TAMURA CORPORATION OF AMERICA
 43352 BUSINESS PARK DRIVE, TEMECULA, CA. 92590-6624
 (909) 699-1270 FAX 9096769482

TTC-8137

MODEL SPECIFICATION

DIM: mm(In) SCL: NONE SH: 1 OF 2

PROPRIETARY NOTICE: THIS DRAWING PRINT OR DOCUMENT AND SUBJECT MATTER DISCLOSED HEREIN ARE PROPRIETARY ITEMS TO WHICH TAMURA RETAINS THE EXCLUSIVE RIGHT OF DISSEMINATION, REPRODUCTION, MANUFACTURE AND SALE. THIS DRAWING, PRINT OR DOCUMENT IS SUBMITTED IN CONFIDENCE FOR CONSIDERATION BY THE RECIPIENT ALONE UNLESS PERMISSION FOR FURTHER DISCLOSURE IS EXPRESSLY GRANTED IN WRITING.

REV. Status

PRELIMINARY
11/06/00 BT

PRELIMINARY 1
DELETED DCR
ON PG. 1, &
ADDED PAD
LAYOUT ON
PG. 2.
11/27/00 LL

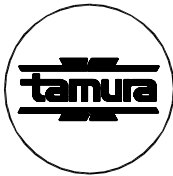

Gigabit Ethernet, 1000 Base-T 24 pin SOIC

MODEL NUMBER
TTC-8137

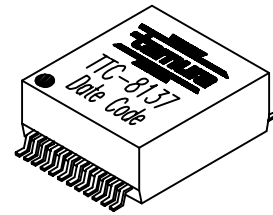

PRELIMINARY

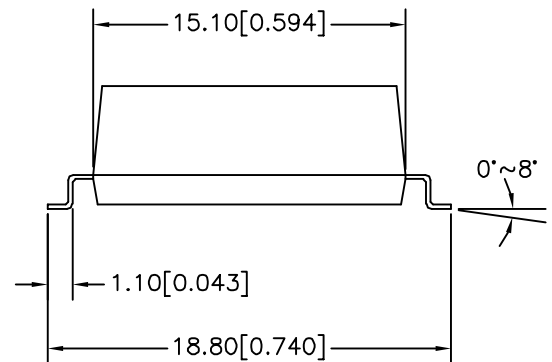
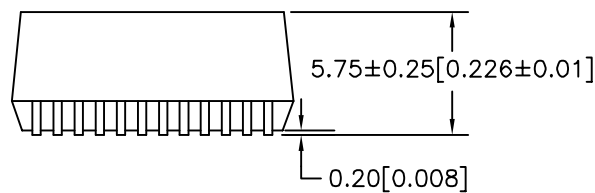
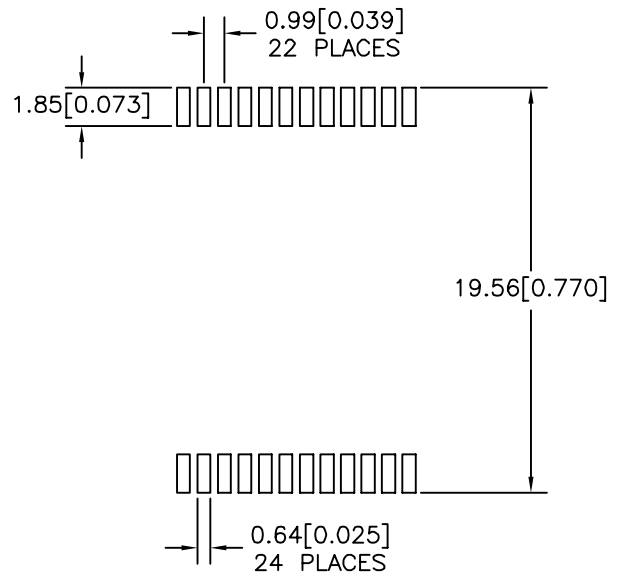
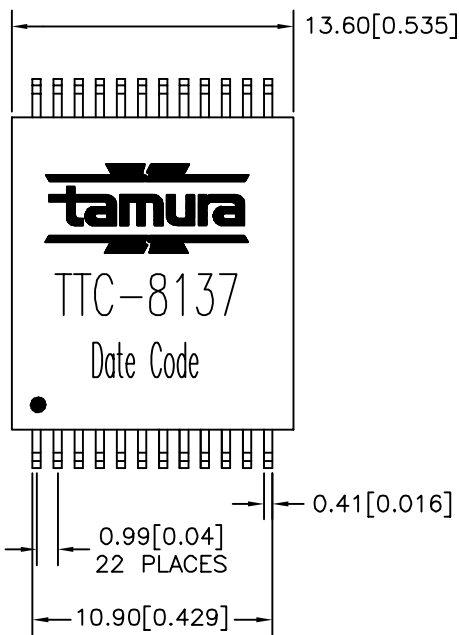

PREPARED BY:

D. Rund

ENGINEER:

L. Le

QUALITY CONTROL:

D. Kelley

APPROVED:

J. Coleman

NOTE: Unless otherwise specified, all dimensions are mm[in] with tolerance of ±0.25[0.010]

DWG CONTROL NO. P-A1-12640 ACAD\TTC\A1126402.DWG	REV PR1	GIGABIT ETHERNET, 1000 BASE-T 24 PIN SOIC	TTC-8137		
CONTENTS OF THIS DRAWING ARE SUBJECT TO CHANGE WITHOUT PRIOR NOTICE		TAMURA CORPORATION OF AMERICA 43352 BUSINESS PARK DRIVE, TEMECULA, CA. 92590-6624 (909) 699-1270 FAX 9096769482	MODEL SPECIFICATION		
		DIM: mm(in)	SCL: 3/1	SH: 2 OF 2	

PROPRIETARY NOTICE: THIS DRAWING PRINT OR DOCUMENT AND SUBJECT MATTER DISCLOSED HEREIN ARE PROPRIETARY ITEMS TO WHICH TAMURA RETAINS THE EXCLUSIVE RIGHT OF DISSEMINATION, REPRODUCTION, MANUFACTURE AND SALE. THIS DRAWING, PRINT OR DOCUMENT IS SUBMITTED IN CONFIDENCE FOR CONSIDERATION BY THE RECIPIENT ALONE UNLESS PERMISSION FOR FURTHER DISCLOSURE IS EXPRESSLY GRANTED IN WRITING.