



ON Semiconductor®

Test Procedure for the NCP1565 3.3-V/20-A Dc-dc Converter



Board Electrical Schematic

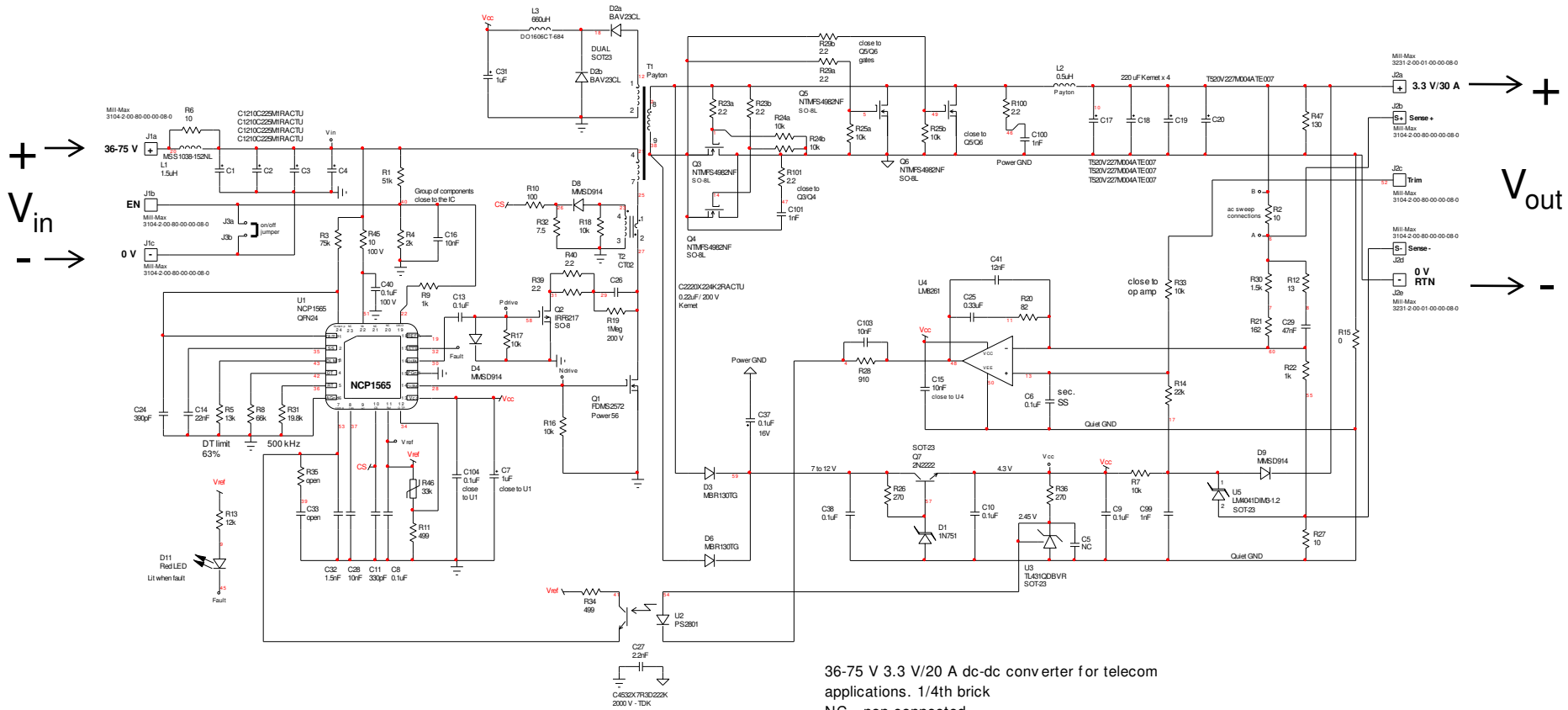

36-75 V 3.3 V/20 A dc-dc converter for telecom applications. 1/4th brick
 NC - non connected

ON Semiconductor
 Christophe Basso - February 17th 2014.
 Rev 1c.
 PCB rev 1

Dc input voltage
 36 – 72 V

3.3 V/20 A
 Output voltage



Board Picture

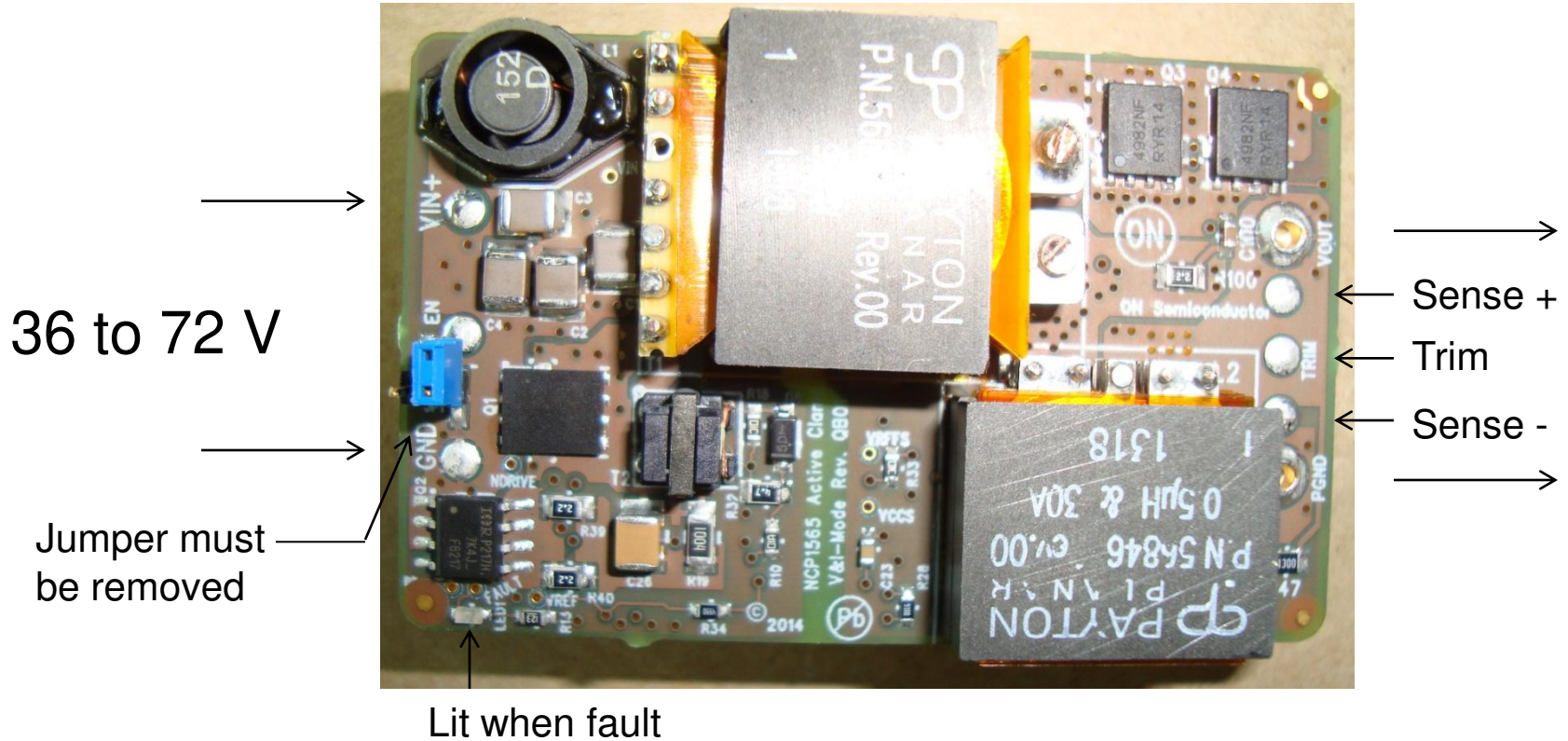

Input voltage from 36 V to 72 V
dc. Nominal input is 48 V

Output voltage is 3.3 V
nominal current is 20 A

Needed Equipment

The needed equipments are the following:

- ❑ a dc voltage source, delivering up to 80 V dc and up to 3 A
- ❑ a dc load absorbing up to 100 W, $V_{in,max} < 20 \text{ V}$, $I_{out,max} < 40 \text{ A}$
- ❑ either the above load can display dc V and dc A or separated V and A-meters are necessary
- ❑ An oscilloscope with single shot capability
- *Kelvin sensing is necessary to connect the load to the board. If no precautions are taken, it is likely that the voltage drop at the load cables ends induces a reading error*



Basic Test Setup

source



load

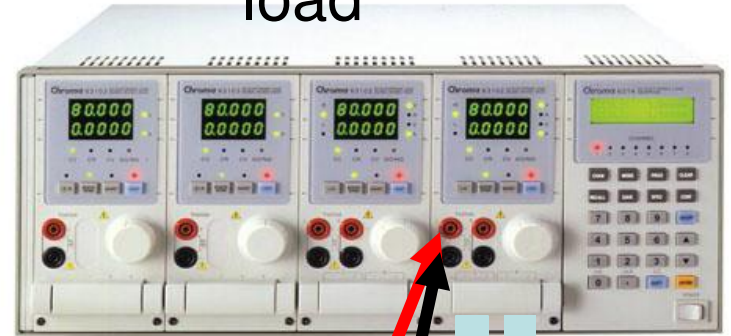

Jumper is removed

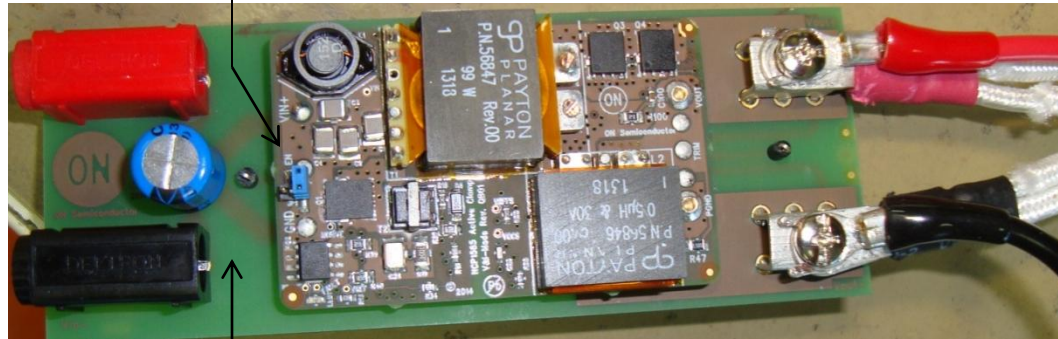

Socket in which the dc-dc is firmly plugged

Kelvin sense

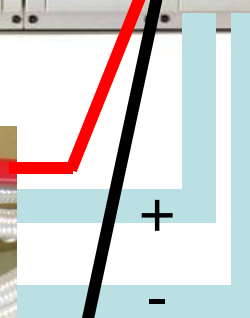

Test n°1

Source = 36 V



Load = 20 A

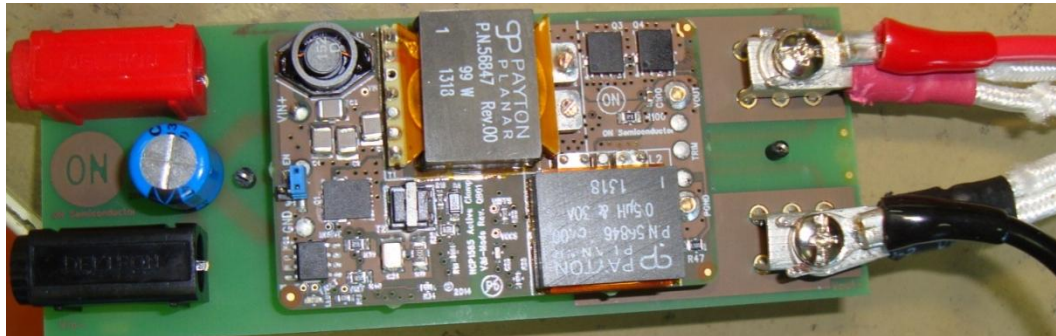
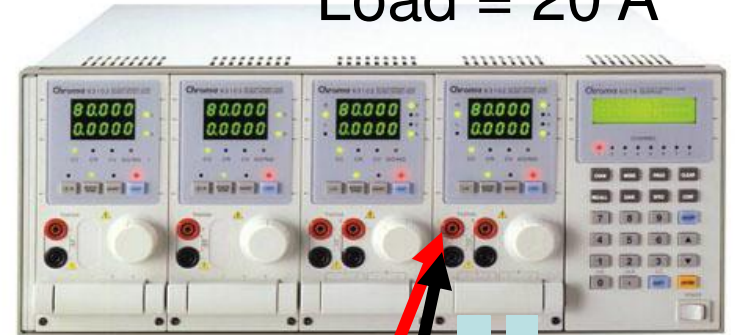

- Start the power supply while the load current is 20 A
- Monitor the output voltage on a scope
- Verify the voltage is monotonically rising

Test n°1

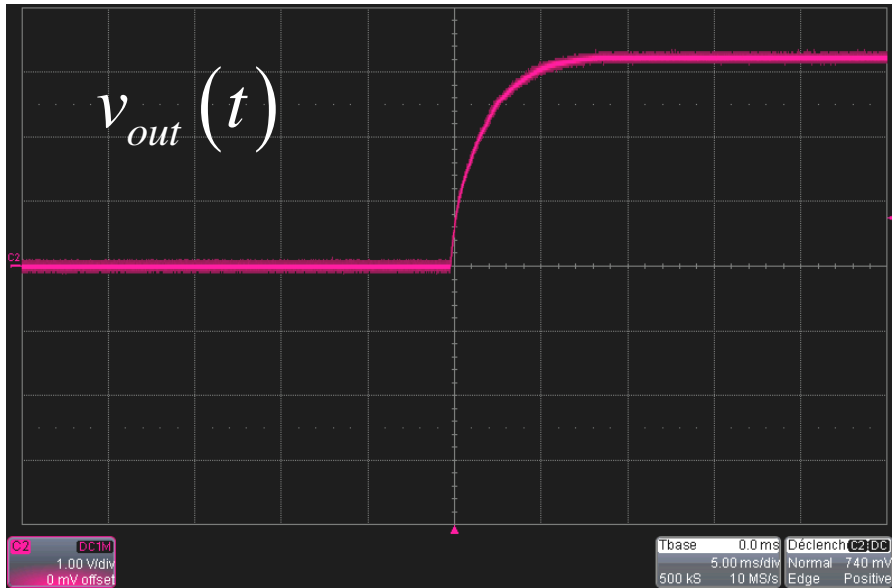

Ok

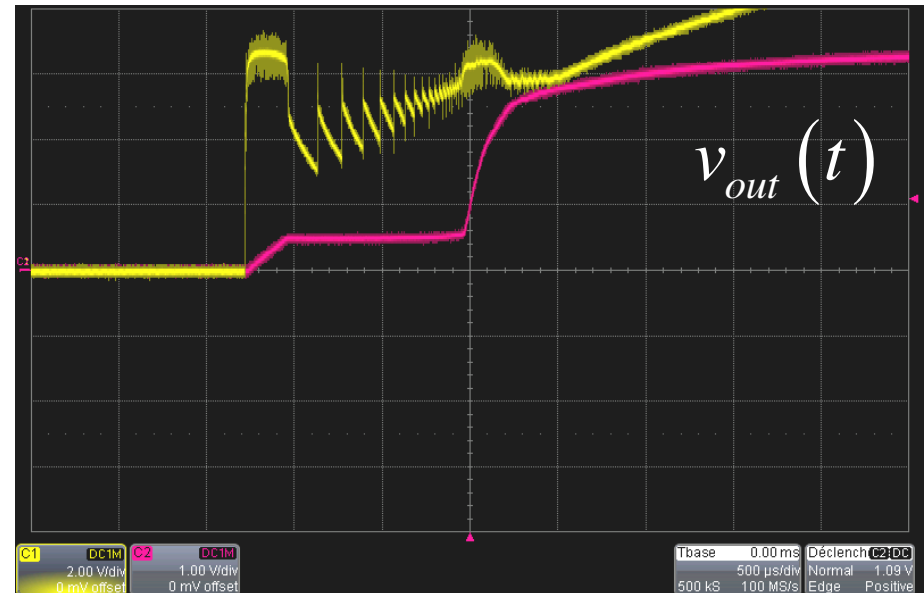

Bad

- It is important to verify the absence of double slope
- Repeat the test for $V_{in} = 48 \text{ V}$ and 72 V
- Change load to 0 A , repeat tests. Wait 10 s between re-starts.

Test n°2

source



load

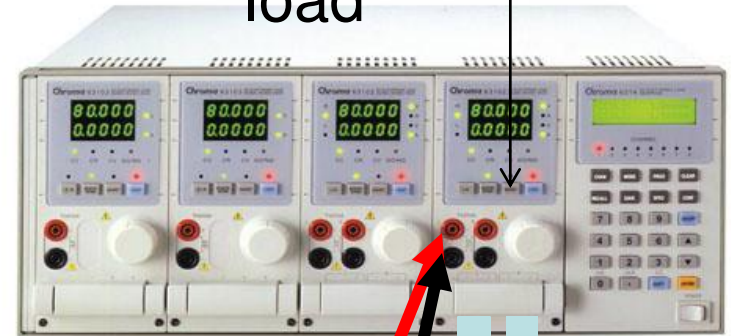

Jumper is removed



- Press short circuit at $V_{in} = 36\text{ V}$. Led blinks, board ticks.
- Repeat test for $V_{in} = 48\text{ V}$ and 72 V
- Release short and make sure output resumes at 3.3 V .

Test n°3

source



load

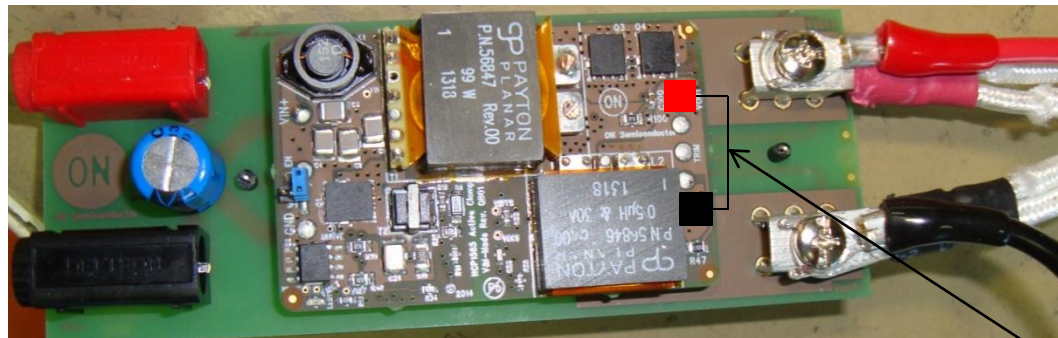
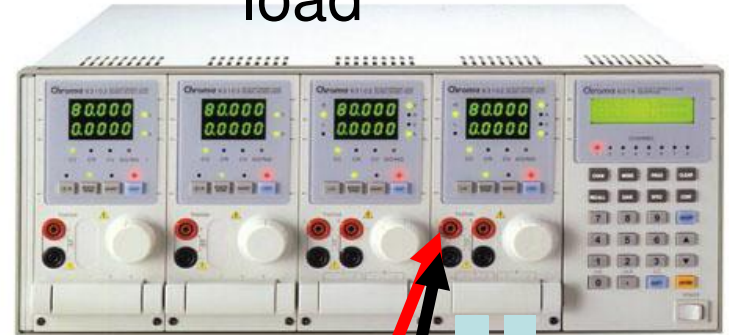

Probe here



No pigtail!

- Program load to dynamic current mode
- I_{out} from 20 A to 15 A, slope 1 A/ μ s
- 1 ms interval, observe V_{out} on scope in ac, 20 mV/div



Test n°3

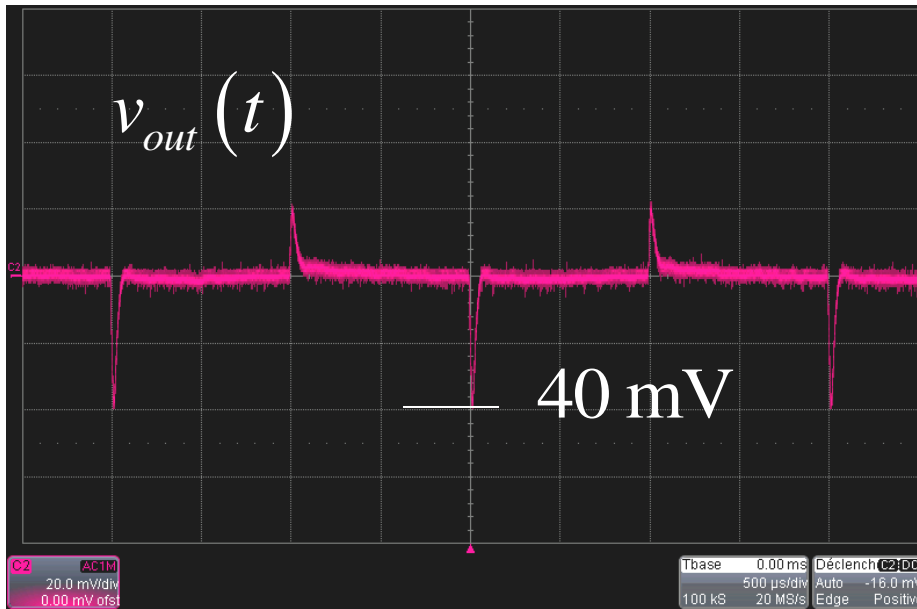

$V_{in} = 36 \text{ V}$ $I_{out} = 15 \text{ to } 20 \text{ A}$, $1 \text{ A}/\mu\text{s}$

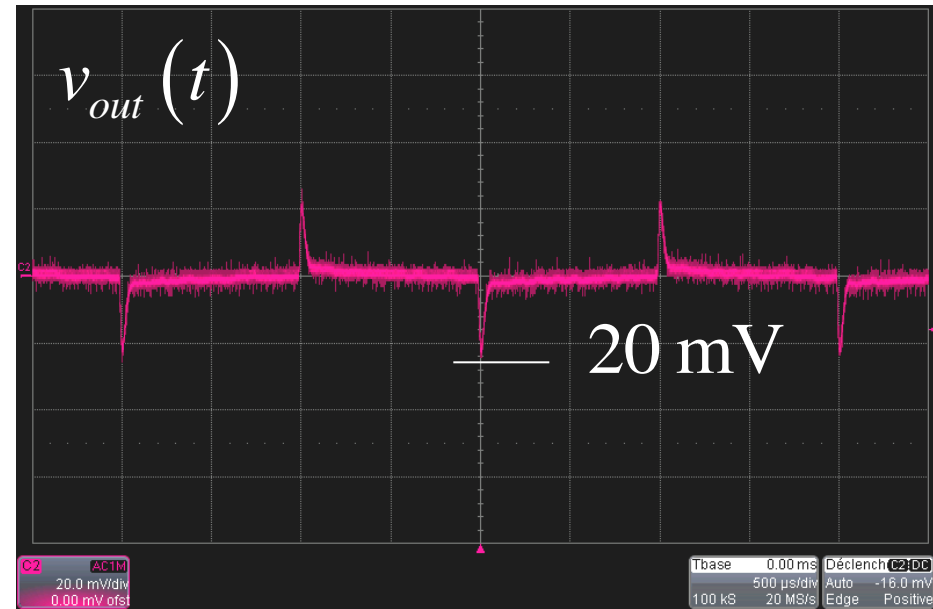

$V_{in} = 48 \text{ V}$ $I_{out} = 15 \text{ to } 20 \text{ A}$, $1 \text{ A}/\mu\text{s}$

- Run the test from $V_{in} = 36 \text{ V}$ (worst case) to $V_{in} = 72 \text{ V}$.
- Spec is to have an under/over shoot less than 60 mV

Test n°4

source



load

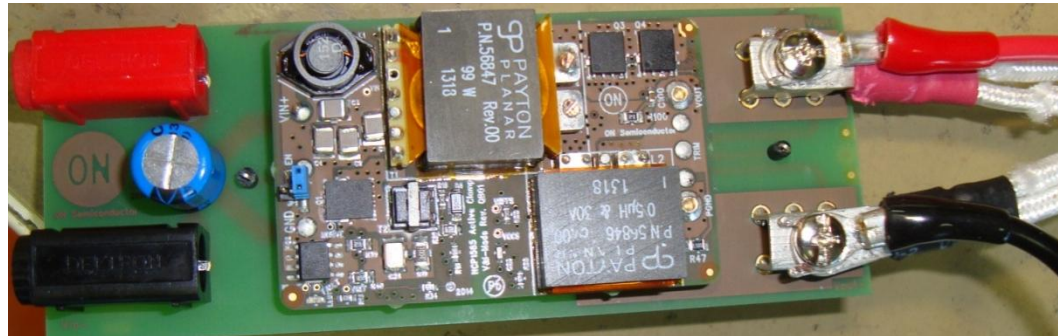
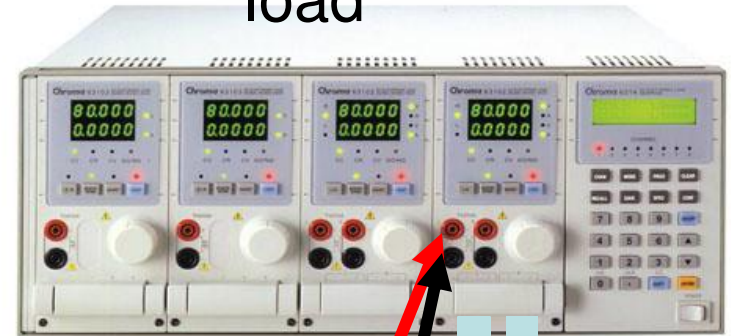

- Leave the board for 5 mn at $V_{in} = 36 \text{ V}/20 \text{ A}$.
- Check no thermal disjonction occurs.
- Board is declared sound.