

P	LTR	DESCRIPTION	DATE	DWN	APVD
	A	RELEASE TO PRODUCTION	22FEB2022	AY	PS

NOTES:

- MATERIAL:  
LCP BLACK, UL94 V0
- N = NUMBER OF POSITION PER HOUSING.
- HOUSING TO BE USED WITH CRIMP CONTACTS  
2316113 (AWG 28-24/0.08-0.22 mm<sup>2</sup>) AND  
2316114 (AWG 30-28/0.05-0.08 mm<sup>2</sup>)
- PACKAGING : BULK BOX  
TUBE PACKAGING IS ON REQUEST ONLY

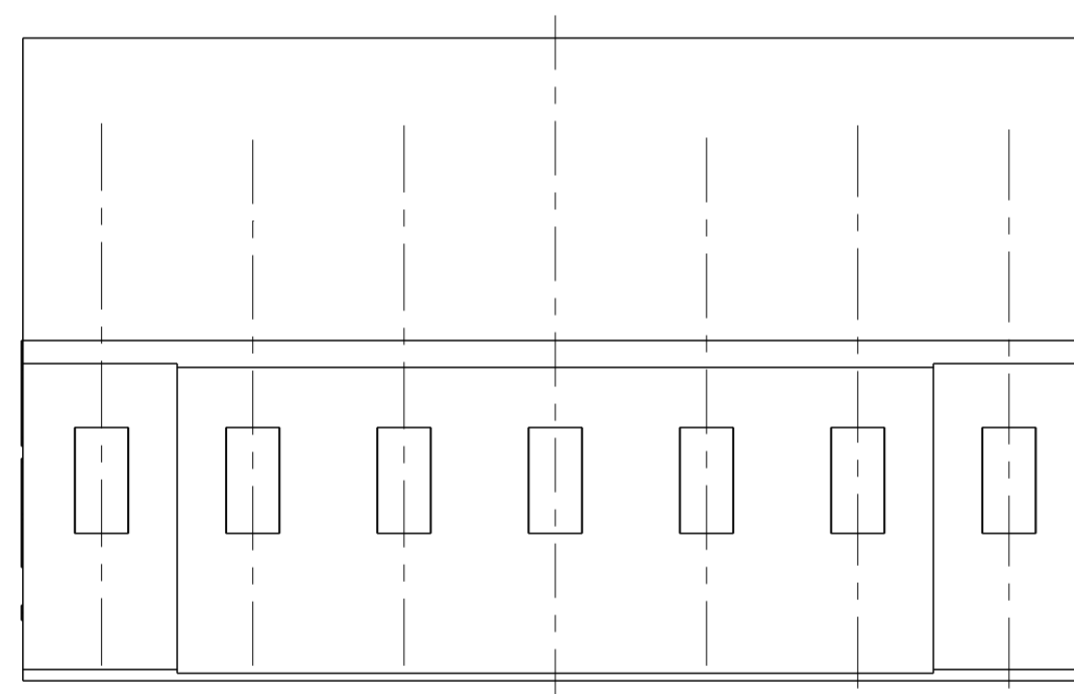
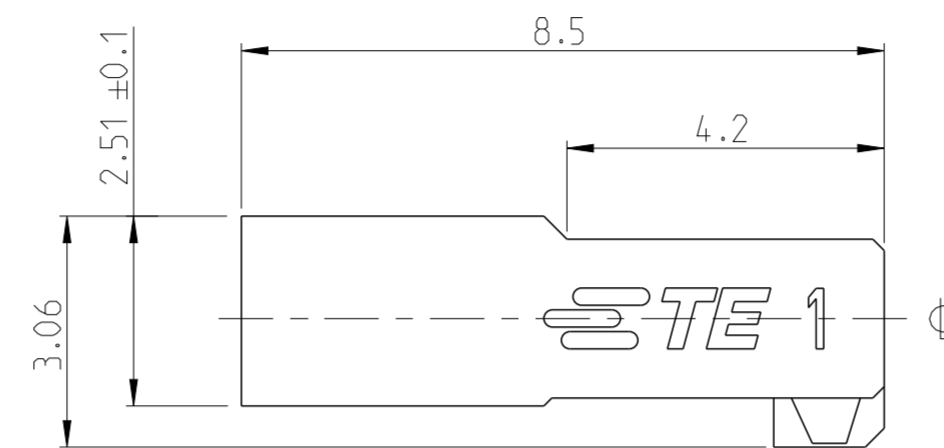
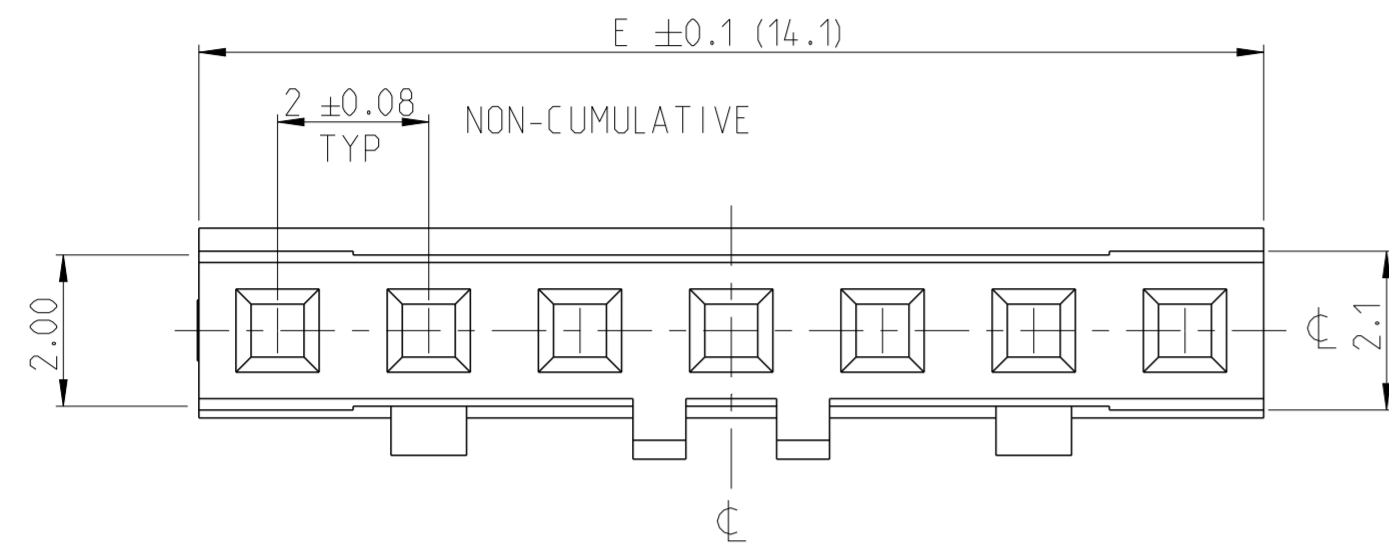

CENTERLINE FOR ODD AND EVEN POSITION HOUSINGS

SCALE 5:1

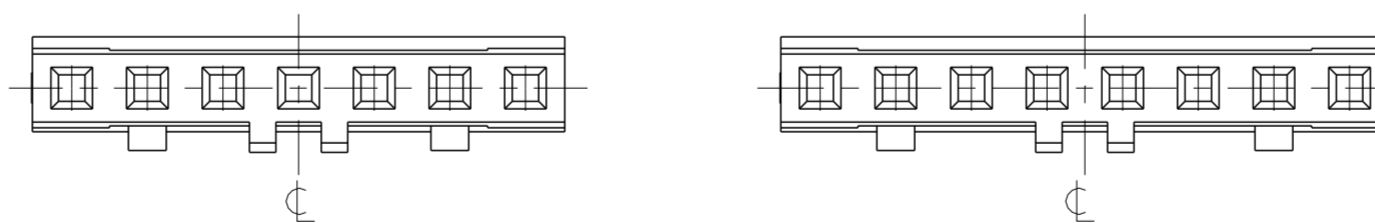

SINGLE ROW HOUSING,  
POLARIZED W/ LOCKING  
RAMP VERSION

-7 AS SHOWN

6:1

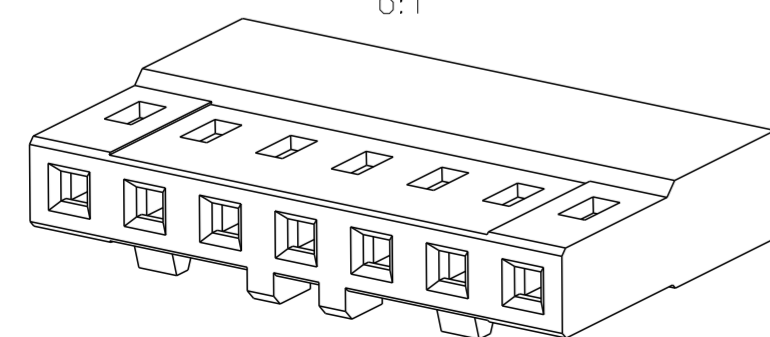

32.1	16	2MM-RCD-S16-BX
30.1	15	2MM-RCD-S15-BX
28.1	14	2MM-RCD-S14-BX
26.1	13	2MM-RCD-S13-BX
24.1	12	2MM-RCD-S12-BX
22.1	11	2MM-RCD-S11-BX
20.1	10	2MM-RCD-S10-BX
18.1	9	2MM-RCD-S09-BX
16.1	8	2MM-RCD-S08-BX
14.1	7	2MM-RCD-S07-BX
DIM "E"	N	SMART PN

THIS DRAWING IS A CONTROLLED DOCUMENT.

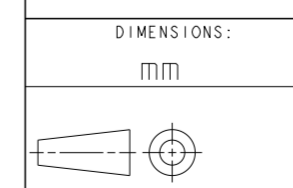

MATERIAL  
SEE NOTE 1

DIMENSIONS:	TOLERANCES UNLESS OTHERWISE SPECIFIED:
0 PLC	±
1 PLC	±0.15
2 PLC	±0.10
3 PLC	±
4 PLC	±
ANGLES	±2°
FINISH	-

DWN	29OCT2016
CHK	29OCT2016
APVD	11DEC2017
PRODUCT SPEC	108-64040-1
APPLICATION SPEC	114-32173
WEIGHT	-
CUSTOMER DRAWING	

TE Connectivity			
NAME			
AMPMODU 2mm RECEPTACLE, w/B HOUSING, CRIMP, SR, W/ LOCK RAMP			
SIZE	CAGE CODE	DRAWING NO	RESTRICTED TO
A2	00779	C-2316103	-
SCALE 10:1		SHEET 1 OF 2	REV A

REVISIONS					
P	LTR	DESCRIPTION	DATE	DWN	APVD
-		SEE SHEET 1	-	-	-

SMART PART NUMBER  
2MM -RCD - S\_\_ - BX

PRODUCT SERIES

2MM	AMPMODU 2mm SERIES
-----	--------------------

GENDER / TYPE

RCD	RECEPTACLE HOUSING FOR CRIMP WITH DETENT LATCH
-----	--

NUMBER OF ROWS

S	SINGLE ROW
---	------------

PACKAGING

BX	BOX
----	-----

NUMBER OF PINS PER ROW

XX	07 THROUGH 16 (ENTER TWO DIGITS)
----	-------------------------------------

SMART PN EXAMPLES:

- 2MM-RCD-S07-BX:  
AMPMODU 2mm, RECEPTACLE HOUSING FOR CRIMP WITH DETENT LATCH, SINGLE ROW, 07 POSITION PER ROW, BOX PACKAGING
- 2MM-RCD-S16-BX:  
AMPMODU 2mm, RECEPTACLE HOUSING FOR CRIMP WITH DETENT LATCH, SINGLE ROW, 16 POSITION PER ROW, BOX PACKAGING

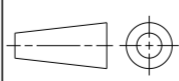
THIS DRAWING IS A CONTROLLED DOCUMENT.		DWN 29OCT2016 RAKSHITH R NAYAK	 TE Connectivity	
		CHK 29OCT2016 RAKSHITH R NAYAK		
DIMENSIONS: mm		TOLERANCES UNLESS OTHERWISE SPECIFIED:		APVD 11DEC2017 PRASHANTH S
		0 PLC ±	NAME AMPMODU 2mm RECEPTACLE, w/B HOUSING, CRIMP, SR, W/ LOCK RAMP	
		1 PLC ±0.15	PRODUCT SPEC 108-64040-1	
		2 PLC ±0.10	APPLICATION SPEC 114-32173	
		3 PLC ±	SIZE A2	
		4 PLC ±	CAGE CODE 00779	
MATERIAL SEE NOTE 1		ANGLES ±2°	DRAWING NO C-2316103	
		FINISH -	RESTRICTED TO -	
		-	SCALE 1:1	
			SHEET 2 OF 2	
			REV A	
			CUSTOMER DRAWING	