

PART NUMBER SEE SHEET 2

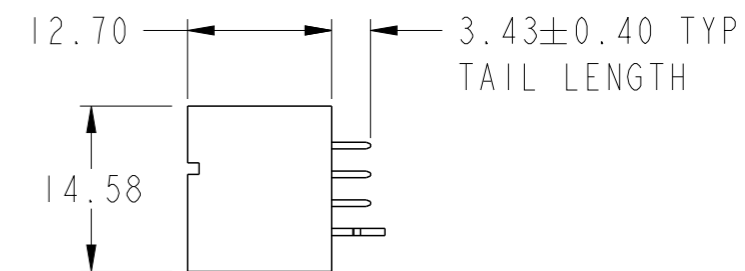

spec ref	*	dr	Zhao Peter	2012/12/07	projection	MM	size	A3	scale	3:2
tolerance std	ASME Y14.5	eng	Peng-Bing Fu	2013/03/11			ecn no	-	rel level	Released
TOLERANCES UNLESS OTHERWISE SPECIFIED		chr	-	-			product family	PwrBlade+		
surface	<input checked="" type="checkbox"/> linear <input type="checkbox"/> angular	0.X	±0.5		title 3HDP PB+ VERTICAL HEADER		dwg no 10106128-3000001	rev A		
		0.XX	±0.25							
		0.XXX	±0.10							
ASME Y14.5	angular	0°	±2°	www.fci.com	cat. no.	Product - Customer Drw	sheet 1 of 3			

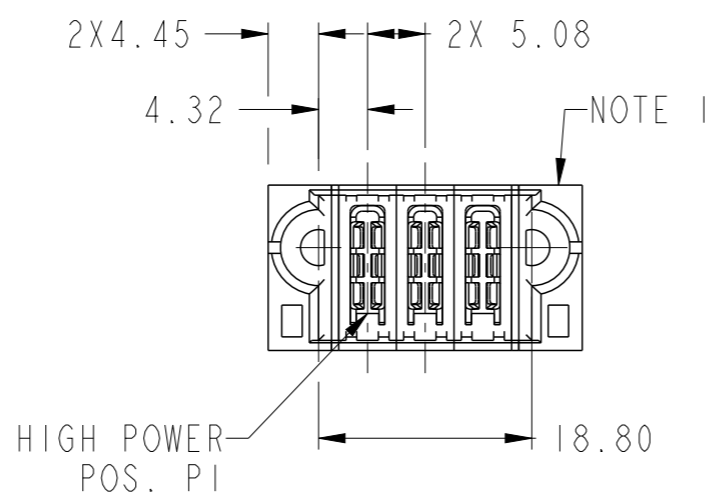
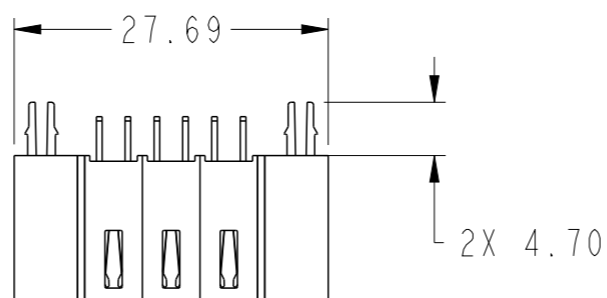
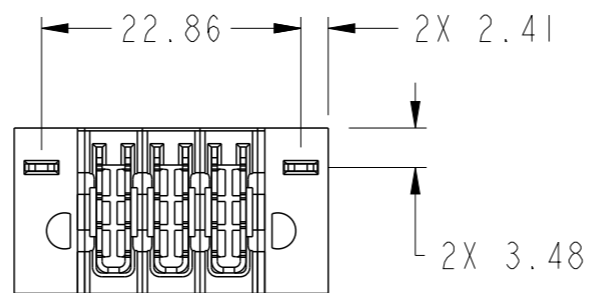

Copyright FCI.

PRODUCT NO.

10106128-3000001LF

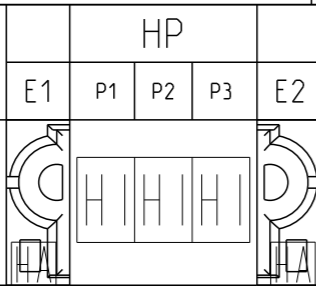

CODE	DESCRIPTION
HI	STD HIGH POWER CONTACT
HA	METAL HOLD DOWN

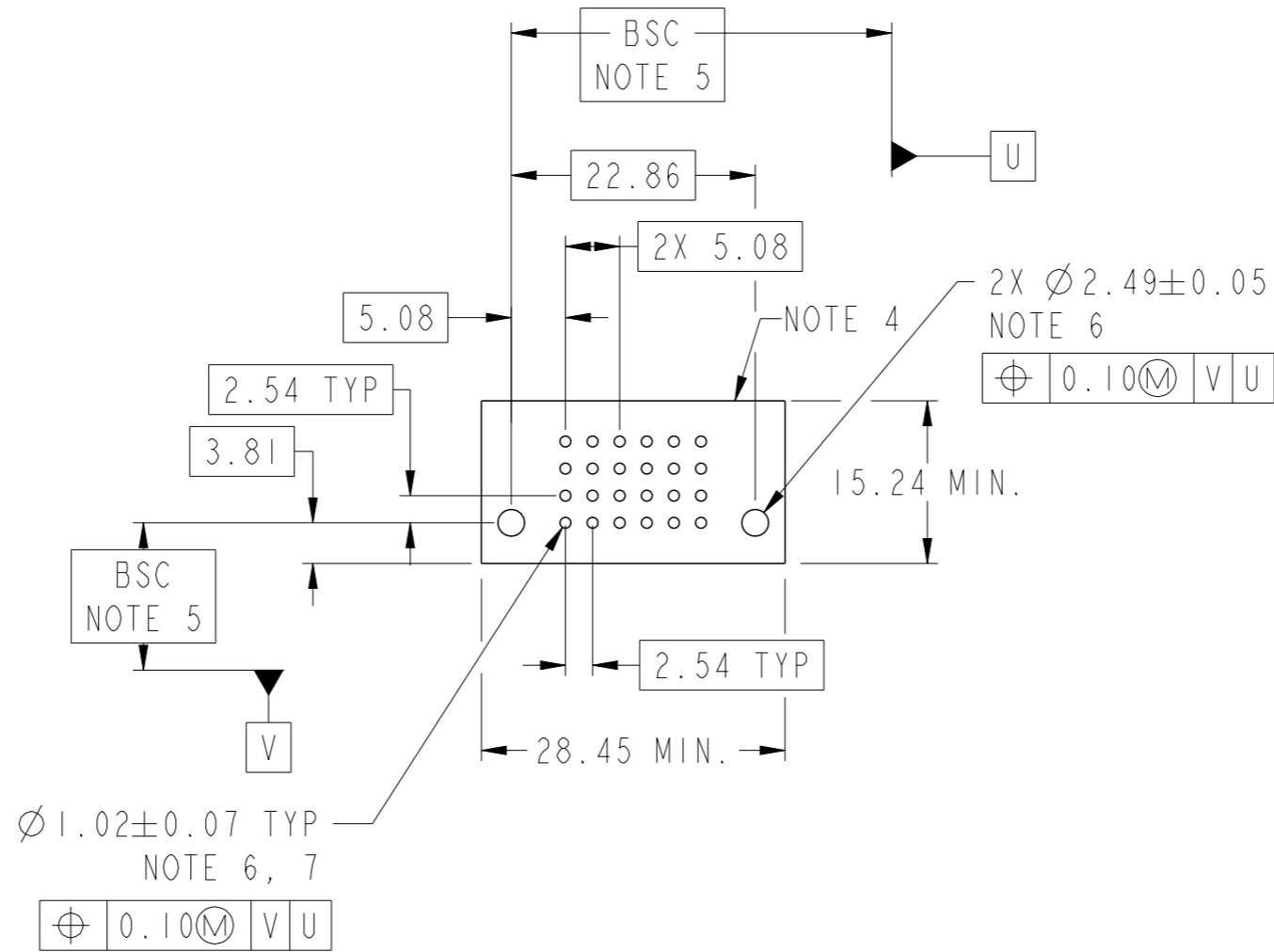

dr	Zhao Peter	2012/12/07	projection	MM	size	A3	scale	3:2	
eng	Peng-Bing Fu	2013/03/11			ecn no	-			
chr	-	-	product family	PwrBlade+	rel level	Released			
appr	Pei-Ming Zheng	2013/03/11			www.fci.com	title	3HDP PB+ VERTICAL HEADER	cat. no.	Product - Customer Drw
					dwg no	10106128-3000001		rev	A



Copyright FCI.

A

B

C

D

A

B

C



D

NOTES:

- 1) "FCI", PART NUMBER AND DATE CODE TO BE MARKED ON THIS SURFACE.  
THE MARK CAN BE OMITTED IF THERE IS NOT ENOUGH SPACE ON THIS SURFACE.
- 2) MATERIALS:  
-HOUSING - GLASS FILLED WITH HIGH TEMP THERMOPLASTIC, UL94V-0.  
-SIGNAL CONTACT - COPPER ALLOY.  
-POWER CONTACT - HIGH CONDUCTIVITY COPPER ALLOY.
- 3) PLATING SPECIFICATION REFER TO FCI 10116351
- 4) DENOTES CONNECTOR KEEP OUT ZONE.
- 5) DATUM AND BASIC DIMENIONS WERE ESTABLISHED BY CUSTOMER.
- 6) ALL HOLE DIAMETERS ARE FINISHED HOLE SIZES.
- 7) 1.15±0.025MM DRILLED HOLE PLATED WITH 0.00762MM MIN Sn  
OVER 0.0254-0.0762MM Cu PLATING TO ACHIEVE A 1.02±0.07MM HOLE.
- 8) PRODUCT SPECIFICATION REFER TO FCI GS-12-658.  
APPLICATION SPECIFICATION REFER TO FCI GS-20-141.  
PRODUCT PACKAGED IN TRAYS, REFER TO FCI GS-14-1502.

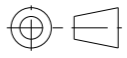
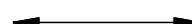

Copyright FCI.

dr	Zhao Peter	2012/12/07	projection 	MM 	size	A3	scale	3:2
eng	Peng-Bing Fu	2013/03/11			ecn no	-		
chr	-	-			rel level	Released		
appr	Pei-Ming Zheng	2013/03/11	product family	PwrBlade+				
		title 3HDP PB+ VERTICAL HEADER	dwg no 10106128-3000001	rev A				
www.fci.com		cat. no.	Product - Customer Drw		sheet 3 of 3			