



# EV5402-R-00A

## 36V, 5A, Frequency-Selectable Step-Down Converter with Smart, Dual USB Charging Ports

### DESCRIPTION

The EV5402-R-00A Evaluation Board is designed to demonstrate the capabilities of MPS' MP5402. MP5402 integrates a monolithic step-down switch mode converter and two USB current limit switches with charging port identification circuit. It achieves 5A continuous output current over a wide input supply range with excellent load and line regulation.

The output of each USB switch is current limited. Both USB ports support DCP schemes for Battery Charging specification (BC1.2), the Divider Mode, and 1.2V/1.2V Mode without the need for outside user interaction.

### ELECTRICAL SPECIFICATION

Parameter	Symbol	Value	Units
Continuous Input Voltage	$V_{IN}$	7-36	V
Switching Frequency	$F_s$	150	KHz
Output Voltage	$V_{USB1}/V_{USB2}$	5	V
Output Current	USB1_lo	2.4	A
	USB2_lo	2.4	A

### FEATURES

- Wide 7V to 36V Operating Input Voltage Range
- Fixed 5V Output Voltage with Line Drop Compensation
- Accurate USB1/USB2 Output Current Limit
- 350kHz/250kHz/150kHz Frequency Selectable
- Programmable Line Drop Compensation
- Supporting DCP schemes for BC1.2, Divider Mode, and 1.2V/1.2V Mode

### APPLICATIONS

- USB Dedicated Charging Port(DCP)
- Automotive Cigarette Lighter Adapters
- Power Supply for Linear Chargers

All MPS parts are lead-free, halogen free, and adhere to the RoHS directive. For MPS green status, please visit MPS website under Quality Assurance.

"MPS" and "The Future of Analog IC Technology" are Registered Trademarks of Monolithic Power Systems, Inc.

ADAM (Analog Digital Adaptive Modulation), AAM (...) are Trademarks of Monolithic Power Systems, Inc.

### EV5402-R-00A EVALUATION BOARD

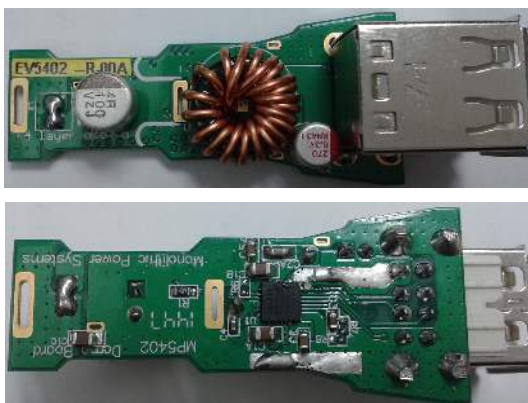

(L x W x H) 5.6cm x 2cm x 1.8cm (Four Layer)

Board Number	MPS IC Number
EV5402-R-00A	MP5402

### Efficiency vs. Load Current

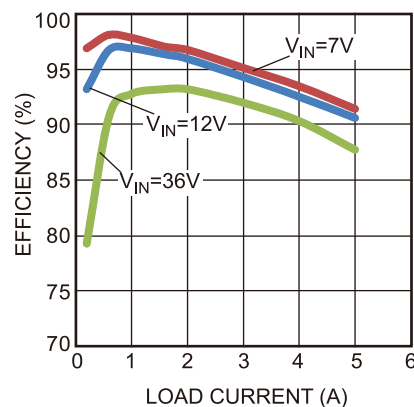

**EVALUATION BOARD SCHEMATIC**

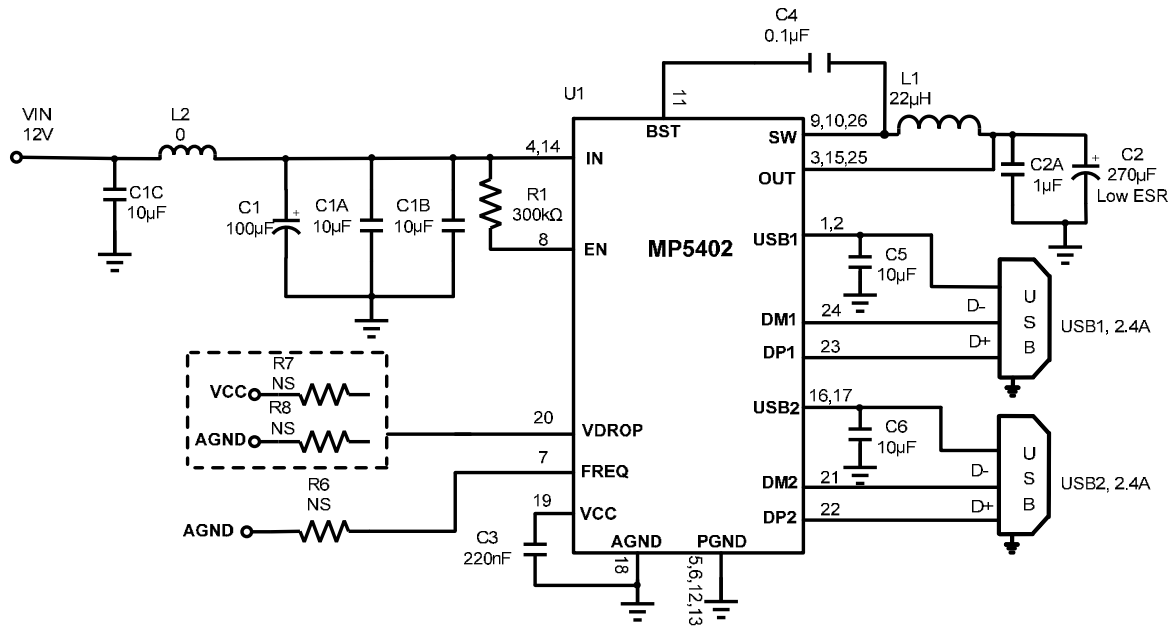

**EV5402-R-00A BILL OF MATERIALS**

Qty	Ref	Value	Description	Package	Manufacturer	Part Number
1	C1	100µF	Aluminum Electrolytic Capacitor, 35V, 160mΩ ESR	DIP	Chemi-Con	EMZJ35ADA101MF80G
2	C1A, C1B	10µF	Ceramic Capacitor, 35V, X5R	0805	TDK	C2012X5R1V106K085AC
1	C1C	10µF	Ceramic Capacitor, 35V, X5R	0805	TDK	C2012X5R1V106K085AC
1	C2	270µF	Polymer Capacitors, 6.3V, 20mΩ ESR	DIP	JTSE	RN271M6R3C070
1	C2A	1µF	Ceramic Capacitor, 16V, X7R	0603	Murata	GRM188R71C105KA12D
1	C3	0.22µF	Ceramic Capacitor, 16V, X7R	0603	Murata	GRM188R71C224KA00A
1	C4	0.1µF	Ceramic Capacitor, 16V, X7R	0402	Murata	GRM155R7C104KA88D
2	C5, C6	10µF	Ceramic Capacitor, 6.3V, X5R	0603	Murata	GRM188R60J106ME47D
1	R1	300kΩ	Film Resistor, 1%	0603	Royal	RL0603FR-07300KL
0	R6, R7, R8	NS				
1	L1	22µH	Toroidal Inductor, 10mΩ DCR	DIP	UEC	WL-756
1	L2	0	Shorted by Wire			
1	USB1/USB2	USB	Dual USB Ports	Tray	Würth	61400826021
1	U1	MP5402	Step Down Converter	QFN26 (4mmx4mm)	MPS	MP5402

## EVB TEST RESULTS

Performance waveforms are tested on the evaluation board.

$V_{IN} = 12V$ ,  $V_{OUT} = 5V$ ,  $L = 22\mu H$ ,  $T_A = 25^\circ C$ , unless otherwise noted.

### Output Ripple

$V_{IN} = 12V$ ,  $V_{OUT} = 5V$ ,  
 $USB1\_I_{OUT} = USB2\_I_{OUT} = 0A$

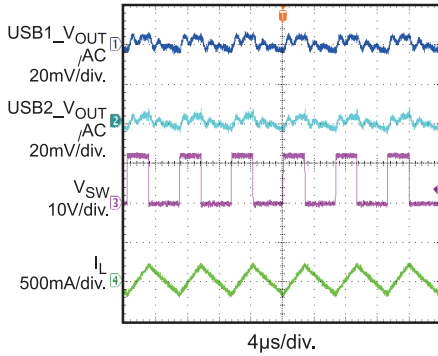

### Output Ripple

$V_{IN} = 12V$ ,  $V_{OUT} = 5V$ ,  
 $USB1\_I_{OUT} = USB2\_I_{OUT} = 2.4A$

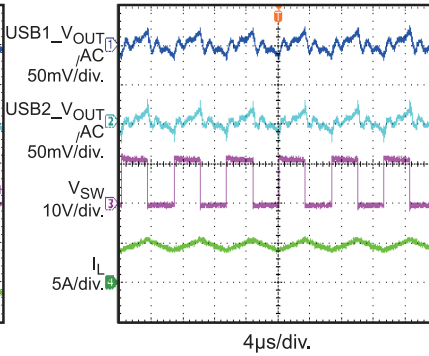

### Power Start-Up

$V_{IN} = 12V$ ,  $V_{OUT} = 5V$ ,  
 $USB1\_I_{OUT} = USB2\_I_{OUT} = 0A$

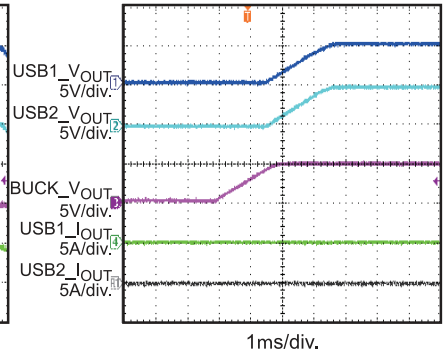

### Power Start-Up

$V_{IN} = 12V$ ,  $V_{OUT} = 5V$ ,  
 $USB1\_I_{OUT} = USB2\_I_{OUT} = 2.4A$ ,  
 CRL Load

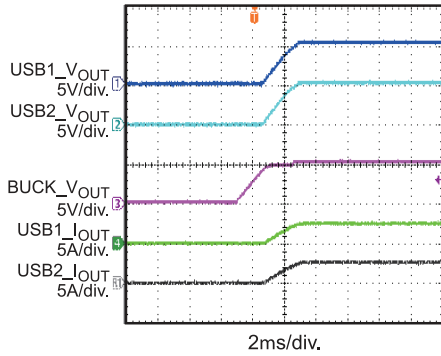

### Power Shutdown

$V_{IN} = 12V$ ,  $V_{OUT} = 5V$ ,  
 $USB1\_I_{OUT} = USB2\_I_{OUT} = 0A$

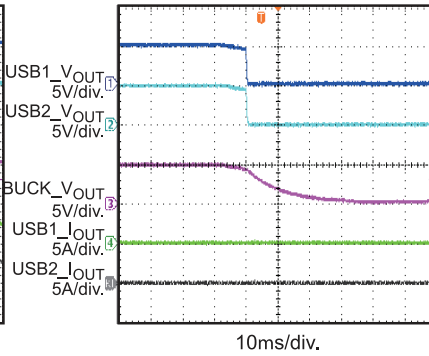

### Power Shutdown

$V_{IN} = 12V$ ,  $V_{OUT} = 5V$ ,  
 $USB1\_I_{OUT} = USB2\_I_{OUT} = 2.4A$ ,  
 CRL Load

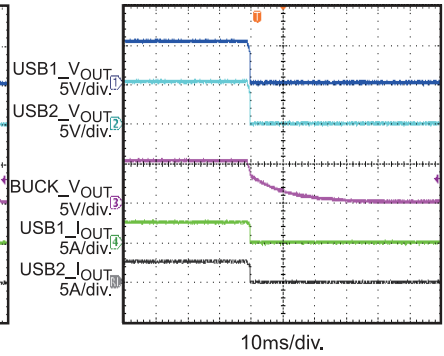

### USB Over-Current Protection

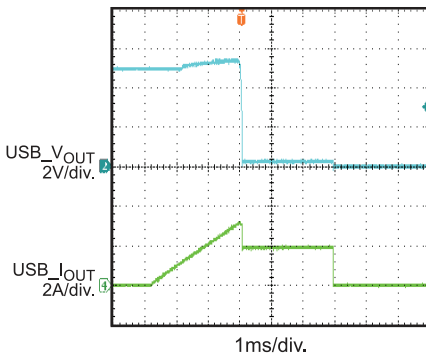

**PRINTED CIRCUIT BOARD LAYOUT**

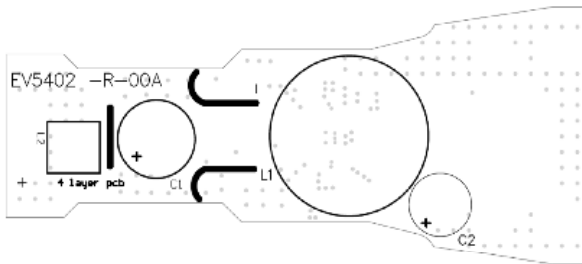

**Figure 1—Top Silk Layer**

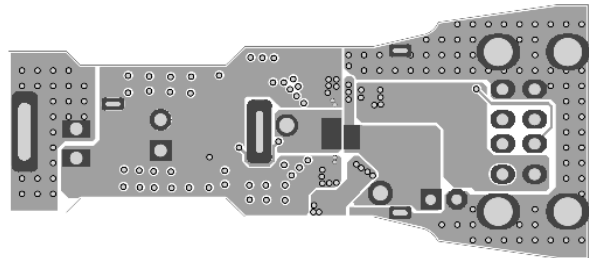

**Figure 2—Top Layer**

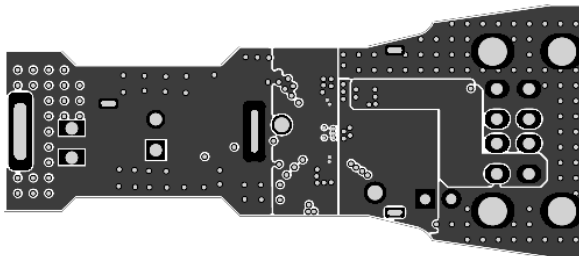

**Figure 3—Mid 1 Layer**

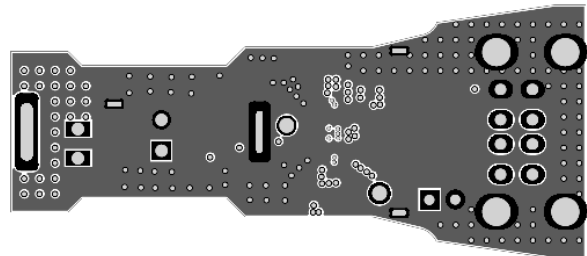

**Figure 4—Mid 2 Layer**

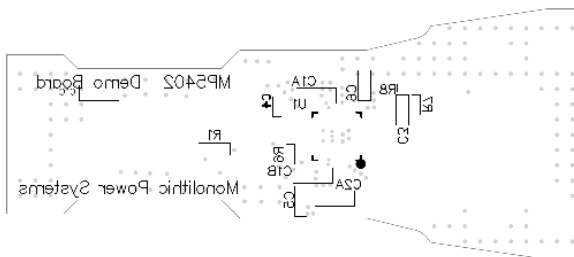

**Figure 5—Bottom Silk Layer**

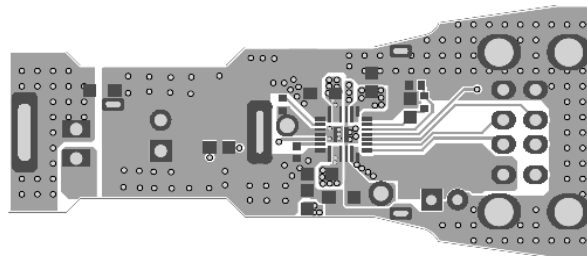

**Figure 6—Bottom Layer**

## QUICK START GUIDE

1. Connect the positive and negative terminals of the load to the USB1, USB2 and GND pins, respectively.
2. Preset the power supply output between 7V and 36V, and then turn off the power supply.
3. Connect the positive and negative terminals of the power supply output to the VIN and GND pins, respectively.
4. Turn the power supply on. The board will automatically start up.
5. To use the Enable function, apply a digital input to the EN pin. Drive EN higher than 2V to turn on the regulator or less than 1V to turn it off.

**NOTICE:** The information in this document is subject to change without notice. Please contact MPS for current specifications. Users should warrant and guarantee that third party Intellectual Property rights are not infringed upon when integrating MPS products into any application. MPS will not assume any legal responsibility for any said applications.