

## 74ABT899

### 9-Bit Latchable Transceiver with Parity Generator/Checker

#### General Description

The ABT899 is a 9-bit to 9-bit parity transceiver with transparent latches. The device can operate as a feed-through transceiver or it can generate/check parity from the 8-bit data busses in either direction.

The ABT899 features independent latch enables for the A-to-B direction and the B-to-A direction, a select pin for ODD/EVEN parity, and separate error signal output pins for checking parity.

#### Features

- Latchable transceiver with output sink of 64 mA
- Option to select generate parity and check or "feed-through" data/parity in directions A-to-B or B-to-A
- Independent latch enables for A-to-B and B-to-A directions
- Select pin for ODD/ $\overline{\text{EVEN}}$  parity
- $\overline{\text{ERRA}}$  and  $\overline{\text{ERRB}}$  output pins for parity checking

- Ability to simultaneously generate and check parity
- May be used in systems applications in place of the 543 and 280
- May be used in system applications in place of the 657 and 373 (no need to change T/R to check parity)
- Guaranteed output skew
- Guaranteed multiple output switching specifications
- Output switching specified for both 50 pF and 250 pF loads
- Guaranteed simultaneous switching noise level and dynamic threshold performance
- Guaranteed latchup protection
- High impedance glitch free bus loading during entire power up and power down cycle
- Nondestructive hot insertion capability
- Disable time less than enable time to avoid bus contention

#### Ordering Code:

Order Number	Package Number	Package Description
74ABT899CSC	M28B	28-Lead Small Outline Integrated Circuit (SOIC), MS-013, 0.300" Wide Body
74ABT899CMSA	MSA28	28-Lead Shrink Small Outline Package (SSOP), EIAJ TYPE II, 5.3mm Wide
74ABT899CQC	V28A	28-Lead Plastic Lead Chip Carrier (PLCC), JEDEC MO-047, 0.450" Square

Devices also available in Tape and Reel. Specify by appending suffix letter "X" to the ordering code.

#### Connection Diagrams

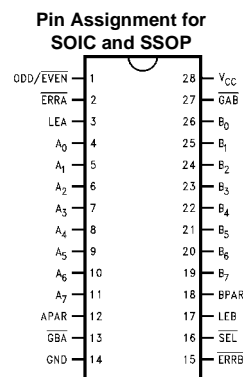
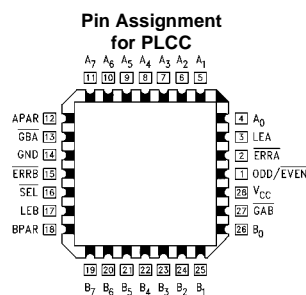

## Pin Descriptions

Pin Names	Descriptions
A <sub>0</sub> -A <sub>7</sub>	A Bus Data Inputs/Data Outputs
B <sub>0</sub> -B <sub>7</sub>	B Bus Data Inputs/Data Outputs
APAR, BPAR	A and B Bus Parity Inputs/Outputs
ODD/ $\overline{\text{EVEN}}$	ODD/ $\overline{\text{EVEN}}$ Parity Select, Active LOW for EVEN Parity
$\overline{\text{GBA}}$ , $\overline{\text{GAB}}$	Output Enables for A or B Bus, Active LOW
$\overline{\text{SEL}}$	Select Pin for Feed-Through or Generate Mode, LOW for Generate Mode
LEA, LEB	Latch Enables for A and B Latches, HIGH for Transparent Mode
$\overline{\text{ERRA}}$ , $\overline{\text{ERRB}}$	Error Signals for Checking Generated Parity with Parity In, LOW if Error Occurs

## Functional Description

The ABT899 has three principal modes of operation which are outlined below. These modes apply to both the A-to-B and B-to-A directions.

- Bus A (B) communicates to Bus B (A), parity is generated and passed on to the B (A) Bus as BPAR (APAR). If LEB (LEA) is HIGH and the Mode Select ( $\overline{\text{SEL}}$ ) is LOW, the parity generated from B[0:7] (A[0:7]) can be checked and monitored by  $\overline{\text{ERRB}}$  ( $\overline{\text{ERRA}}$ ).
- Bus A (B) communicates to Bus B (A) in a feed-through mode if  $\overline{\text{SEL}}$  is HIGH. Parity is still generated and checked as  $\overline{\text{ERRA}}$  and  $\overline{\text{ERRB}}$  in the feed-through mode (can be used as an interrupt to signal a data/parity bit error to the CPU).
- Independent Latch Enables (LEA and LEB) allow other permutations of generating/checking (see Function Table below).

## Function Table

Inputs					Operation
GAB	GBA	SEL	LEA	LEB	
H	H	X	X	X	Busses A and B are 3-STATE.
H	L	L	L	H	Generates parity from B[0:7] based on O/ $\overline{\text{E}}$ (Note 1). Generated parity $\rightarrow$ APAR. Generated parity checked against BPAR and output as $\overline{\text{ERRB}}$ .
H	L	L	H	H	Generates parity from B[0:7] based on O/ $\overline{\text{E}}$ . Generated parity $\rightarrow$ APAR. Generated parity checked against BPAR and output as $\overline{\text{ERRB}}$ . Generated parity also fed back through the A latch for generate/check as $\overline{\text{ERRA}}$ .
H	L	L	X	L	Generates parity from B latch data based on O/ $\overline{\text{E}}$ . Generated parity $\rightarrow$ APAR. Generated parity checked against latched BPAR and output as $\overline{\text{ERRB}}$ .
H	L	H	X	H	BPAR/B[0:7] $\rightarrow$ APAR/A[0:7] Feed-through mode. Generated parity checked against BPAR and output as $\overline{\text{ERRB}}$ .
H	L	H	H	H	BPAR/B[0:7] $\rightarrow$ APAR/A[0:7] Feed-through mode. Generated parity checked against BPAR and output as $\overline{\text{ERRB}}$ . Generated parity also fed back through the A latch for generate/check as $\overline{\text{ERRA}}$ .
L	H	L	H	L	Generates parity for A[0:7] based on O/ $\overline{\text{E}}$ . Generated parity $\rightarrow$ BPAR. Generated parity checked against APAR and output as $\overline{\text{ERRA}}$ .
L	H	L	H	H	Generates parity from A[0:7] based on O/ $\overline{\text{E}}$ . Generated parity $\rightarrow$ BPAR. Generated parity checked against APAR and output as $\overline{\text{ERRA}}$ . Generated parity also fed back through the B latch for generate/check as $\overline{\text{ERRB}}$ .
L	H	L	L	X	Generates parity from A latch data based on O/ $\overline{\text{E}}$ . Generated parity $\rightarrow$ BPAR. Generated parity checked against latched APAR and output as $\overline{\text{ERRA}}$ .
L	H	H	H	L	APAR/A[0:7] $\rightarrow$ BPAR/B[0:7] Feed-through mode. Generated parity checked against APAR and output as $\overline{\text{ERRA}}$ .
L	H	H	H	H	APAR/A[0:7] $\rightarrow$ BPAR/B[0:7] Feed-through mode. Generated parity checked against APAR and output as $\overline{\text{ERRA}}$ . Generated parity also fed back through the B latch for generate/check as $\overline{\text{ERRB}}$ .

H = HIGH Voltage Level

L = LOW Voltage Level

X = Immaterial

Note 1: O/ $\overline{\text{E}}$  = ODD/ $\overline{\text{EVEN}}$

# Functional Block Diagram

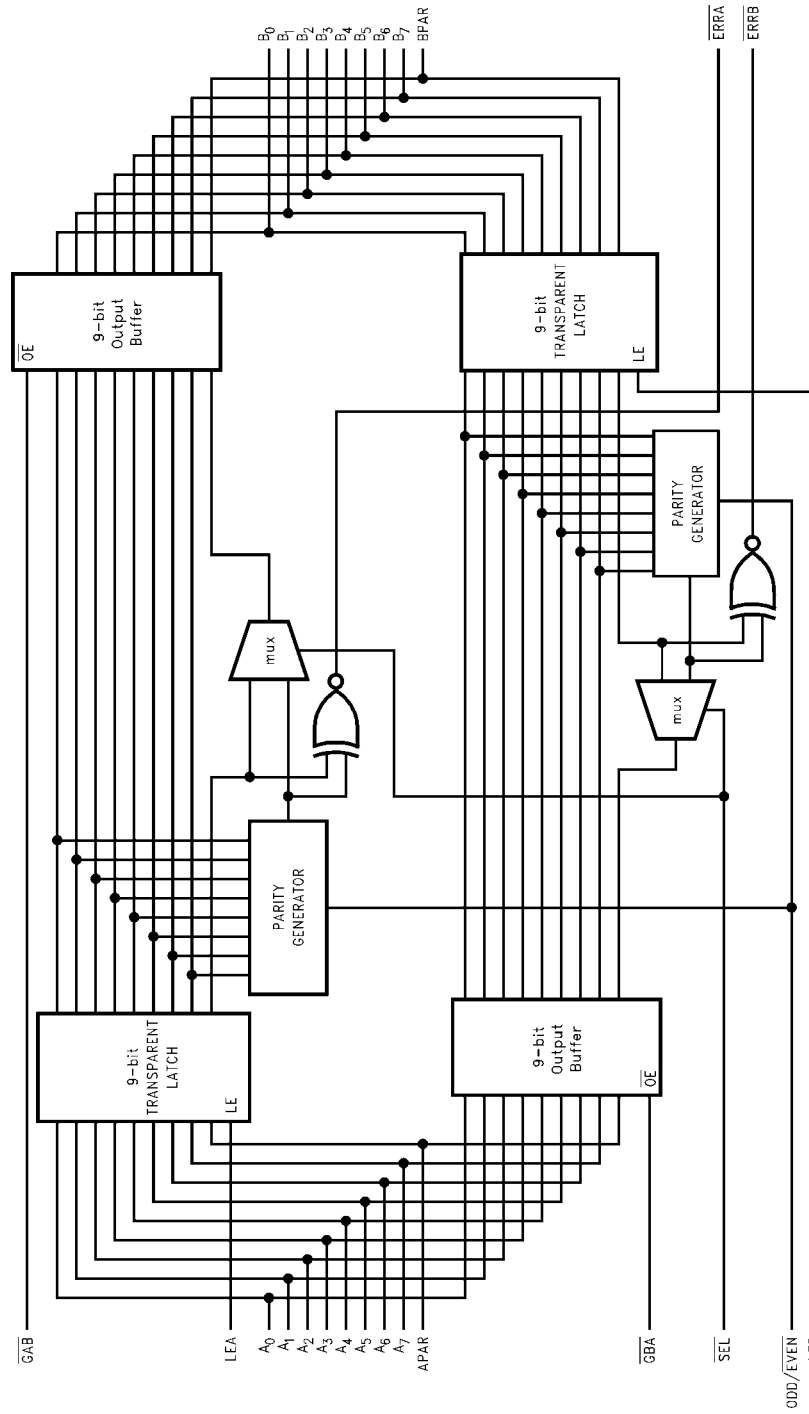

74ABT899

Absolute Maximum Ratings (Note 2)		DC Latchup Source Current	-500 mA
Storage Temperature	-65°C to +150°C	Over Voltage Latchup (I/O)	10V
Ambient Temperature under Bias	-55°C to +125°C	<b>Recommended Operating Conditions</b>	
Junction Temperature under Bias		Free Air Ambient Temperature	-40°C to +85°C
Plastic	-55°C to +150°C	Supply Voltage	+4.5V to +5.5V
V <sub>CC</sub> Pin Potential to Ground Pin	-0.5V to +7.0V	Minimum Input Edge Rate ( $\Delta V/\Delta t$ )	
Input Voltage (Note 3)	-0.5V to +7.0V	Data Input	50 mV/ns
Input Current (Note 3)	-30 mA to +5.0 mA	Enable Input	20 mV/ns
Voltage Applied to Any Output in the Disable or Power-Off State	-0.5V to +5.5V	<b>Note 2:</b> Absolute maximum ratings are values beyond which the device may be damaged or have its useful life impaired. Functional operation under these conditions is not implied.	
in the HIGH State	-0.5V to V <sub>CC</sub>	<b>Note 3:</b> Either voltage limit or current limit is sufficient to protect inputs.	
Current Applied to Output in LOW State (Max)	twice the rated I <sub>OL</sub> (mA)		

### DC Electrical Characteristics

Symbol	Parameter	Min	Typ	Max	Units	V <sub>CC</sub>	Conditions
V <sub>IH</sub>	Input HIGH Voltage	2.0			V		Recognized HIGH Signal
V <sub>IL</sub>	Input LOW Voltage			0.8	V		Recognized LOW Signal
V <sub>CD</sub>	Input Clamp Diode Voltage			-1.2	V	Min	I <sub>IN</sub> = -18 mA (Non I/O Pins)
V <sub>OH</sub>	Output HIGH Voltage	2.5			V	Min	I <sub>OH</sub> = -3 mA, (A <sub>n</sub> , B <sub>n</sub> , APAR, BPAR) I <sub>OH</sub> = -32 mA, (A <sub>n</sub> , B <sub>n</sub> , APAR, BPAR)
V <sub>OL</sub>	Output LOW Voltage			0.55	V	Min	I <sub>OL</sub> = 64 mA, (A <sub>n</sub> , B <sub>n</sub> , APAR, BPAR)
V <sub>ID</sub>	Input Leakage Test	4.75			V	0.0	I <sub>ID</sub> = 1.9 $\mu$ A, (Non-I/O Pins) All Other Pins Grounded
I <sub>IH</sub>	Input HIGH Current			5	$\mu$ A	Max	V <sub>IN</sub> = 2.7V (Non-I/O Pins) (Note 4) V <sub>IN</sub> = V <sub>CC</sub> (Non-I/O Pins)
I <sub>BVI</sub>	Input HIGH Current Breakdown Test			7	$\mu$ A	Max	V <sub>IN</sub> = 7.0V (Non-I/O Pins)
I <sub>BVIT</sub>	Input HIGH Current Breakdown Test (I/O)			100	$\mu$ A	Max	V <sub>IN</sub> = 5.5V (A <sub>n</sub> , B <sub>n</sub> , APAR, BPAR)
I <sub>IL</sub>	Input LOW Current			-5	$\mu$ A	Max	V <sub>IN</sub> = 0.5V (Non-I/O Pins) (Note 4) V <sub>IN</sub> = 0.0V (Non-I/O Pins)
I <sub>IH</sub> + I <sub>OZH</sub>	Output Leakage Current			50	$\mu$ A	0V-5.5V	V <sub>OUT</sub> = 2.7V (A <sub>n</sub> , B <sub>n</sub> ); G <sub>AB</sub> and G <sub>BA</sub> = 2.0V
I <sub>IL</sub> + I <sub>OZL</sub>	Output Leakage Current			-50	$\mu$ A	0V-5.5V	V <sub>OUT</sub> = 0.5V (A <sub>n</sub> , B <sub>n</sub> ); G <sub>AB</sub> and G <sub>BA</sub> = 2.0V
I <sub>OS</sub>	Output Short-Circuit Current	-100		-275	mA	Max	V <sub>OUT</sub> = 0V (A <sub>n</sub> , B <sub>n</sub> , APAR, BPAR)
I <sub>CEX</sub>	Output HIGH Leakage Current			50	$\mu$ A	Max	V <sub>OUT</sub> = V <sub>CC</sub> (A <sub>n</sub> , B <sub>n</sub> , APAR, BPAR)
I <sub>ZZ</sub>	Bus Drainage Test			100	$\mu$ A	0.0V	V <sub>OUT</sub> = 5.5V (A <sub>n</sub> , B <sub>n</sub> , APAR, BPAR); All Others GND
I <sub>CCH</sub>	Power Supply Current			250	$\mu$ A	Max	All Outputs HIGH
I <sub>CCL</sub>	Power Supply Current			34	mA	Max	All Outputs LOW, ERR A/B = HIGH (Note 5)
I <sub>CCZ</sub>	Power Supply Current			250	$\mu$ A	Max	Outputs 3-STATE All Others at V <sub>CC</sub> or GND
I <sub>CCT</sub>	Additional I <sub>CC</sub> /Input			2.5	mA	Max	V <sub>I</sub> = V <sub>CC</sub> - 2.1V All Others at V <sub>CC</sub> or GND
I <sub>CCD</sub>	Dynamic I <sub>CC</sub> : No Load (Note 4)			0.4	mA/MHz	Max	Outputs Open G <sub>AB</sub> or G <sub>BA</sub> = GND, LE = HIGH Non-I/O = GND or V <sub>CC</sub> One bit toggling, 50% duty cycle

**Note 4:** Guaranteed, but not tested.

**Note 5:** Add 3.75 mA for each ERR LOW.

DC Electrical Characteristics							
(PLCC package)							
Symbol	Parameter	Min	Typ	Max	Units	V <sub>CC</sub>	Conditions C <sub>L</sub> = 50 pF, R <sub>L</sub> = 500Ω
V <sub>OLP</sub>	Quiet Output Maximum Dynamic V <sub>OL</sub>		0.8	1.1	V	5.0	T <sub>A</sub> = 25°C (Note 6)
V <sub>OLV</sub>	Quiet Output Minimum Dynamic V <sub>OL</sub>	-1.3	-0.8		V	5.0	T <sub>A</sub> = 25°C (Note 6)
V <sub>OHV</sub>	Minimum HIGH Level Dynamic Output Voltage	2.5	3.0		V	5.0	T <sub>A</sub> = 25°C (Note 8)
V <sub>IHD</sub>	Minimum HIGH Level Dynamic Input Voltage	2.2	1.8		V	5.0	T <sub>A</sub> = 25°C (Note 7)
V <sub>ILD</sub>	Maximum LOW Level Dynamic Input Voltage		0.8	0.5	V	5.0	T <sub>A</sub> = 25°C (Note 7)
<p><b>Note 6:</b> Max number of outputs defined as (n). n – 1 data inputs are driven 0V to 3V. One output at LOW. Guaranteed, but not tested.</p> <p><b>Note 7:</b> Max number of data inputs (n) switching. n – 1 inputs switching 0V to 3V. Input-under-test switching: 3V to threshold (V<sub>ILD</sub>), 0V to threshold (V<sub>IHD</sub>). Guaranteed, but not tested.</p> <p><b>Note 8:</b> Max number of outputs defined as (n). n – 1 data inputs are driven 0V to 3V. One output HIGH. Guaranteed, but not tested.</p>							
AC Electrical Characteristics							
(SOIC and PLCC Package)							
Symbol	Parameter	T <sub>A</sub> = +25°C V <sub>CC</sub> = +5.0V C <sub>L</sub> = 50 pF			T <sub>A</sub> = -40°C to +85°C V <sub>CC</sub> = 4.5V–5.5V C <sub>L</sub> = 50 pF		Units
		Min	Typ	Max	Min	Max	
t <sub>PLH</sub>	Propagation Delay	1.5	3.0	4.8	1.5	4.8	ns
t <sub>PHL</sub>	A <sub>n</sub> to B <sub>n</sub>	1.5	3.5	4.8	1.5	4.8	
t <sub>PLH</sub>	Propagation Delay	2.5	5.9	9.2	2.5	9.2	ns
t <sub>PHL</sub>	A <sub>n</sub> , B <sub>n</sub> to BPAR, APAR	2.5	5.8	9.2	2.5	9.2	
t <sub>PLH</sub>	Propagation Delay	2.5	5.4	8.5	2.5	8.5	ns
t <sub>PHL</sub>	A <sub>n</sub> , B <sub>n</sub> to $\overline{\text{ERRA}}$ , $\overline{\text{ERRB}}$	2.5	5.4	8.5	2.5	8.5	
t <sub>PLH</sub>	Propagation Delay	1.5	3.7	6.0	1.5	6.0	ns
t <sub>PHL</sub>	APAR, BPAR to $\overline{\text{ERRA}}$ , $\overline{\text{ERRB}}$	1.5	3.7	6.0	1.5	6.0	
t <sub>PLH</sub>	Propagation Delay	2.0	4.4	6.9	2.0	6.9	ns
t <sub>PHL</sub>	ODD/EVEN to APAR, BPAR	2.0	4.4	6.9	2.0	6.9	
t <sub>PLH</sub>	Propagation Delay	1.8	4.0	6.0	1.8	6.0	ns
t <sub>PHL</sub>	ODD/ $\overline{\text{EVEN}}$ to $\overline{\text{ERRA}}$ , $\overline{\text{ERRB}}$	1.8	4.0	6.0	1.8	6.0	
t <sub>PLH</sub>	Propagation Delay	1.5	3.8	6.0	1.5	6.0	ns
t <sub>PHL</sub>	SEL to APAR, BPAR	1.5	3.8	6.0	1.5	6.0	
t <sub>PLH</sub>	Propagation Delay	1.5	3.2	4.6	1.5	4.6	ns
t <sub>PHL</sub>	LEA, LEB to B <sub>n</sub> , A <sub>n</sub>	1.5	3.2	4.6	1.5	4.6	
t <sub>PLH</sub>	Propagation Delay	2.5	5.9	8.8	2.5	8.8	ns
t <sub>PHL</sub>	LEA, LEB to BPAR, APAR Generate Mode	2.5	5.7	8.8	2.5	8.8	
t <sub>PLH</sub>	Propagation Delay	1.5	3.6	5.1	1.5	5.1	ns
t <sub>PHL</sub>	LEA, LEB to BPAR, APAR, Feed Thru Mode	1.5	3.6	5.1	1.5	5.1	
t <sub>PLH</sub>	Propagation Delay	1.6	5.4	8.4	1.6	8.4	ns
t <sub>PHL</sub>	LEA, LEB to $\overline{\text{ERRA}}$ , $\overline{\text{ERRB}}$	1.6	5.4	8.4	1.6	8.4	
t <sub>PZH</sub>	Output Enable Time	1.5	3.6	6.0	1.5	6.0	ns
t <sub>PZL</sub>	$\overline{\text{GBA}}$ or $\overline{\text{GAB}}$ to A <sub>n</sub> , APAR or B <sub>n</sub> , BPAR	1.5	3.4	6.0	1.5	6.0	
t <sub>PHZ</sub>	Output Disable Time	1.0	4.0	6.0	1.0	6.0	ns
t <sub>PLZ</sub>	$\overline{\text{GBA}}$ or $\overline{\text{GAB}}$ to A <sub>n</sub> , APAR or B <sub>n</sub> , BPAR	1.0	3.3	6.0	1.0	6.0	
t <sub>PLH</sub> t <sub>PHL</sub>	Propagation Delay	1.5	3.3	5.4	1.5	5.4	ns
	APAR to BPAR, BPAR to APAR	1.5	3.8	5.4	1.5	5.4	

AC Electrical Characteristics							
(SSOP Package)							
Symbol	Parameter	T <sub>A</sub> = +25°C V <sub>CC</sub> = +5.0V C <sub>L</sub> = 50 pF			T <sub>A</sub> = -40°C to +85°C V <sub>CC</sub> = 4.5V-5.5V C <sub>L</sub> = 50 pF		Units
		Min	Typ	Max	Min	Max	
t <sub>PLH</sub>	Propagation Delay	1.5	3.0	5.3	1.5	5.3	ns
t <sub>PHL</sub>	A <sub>n</sub> , to B <sub>n</sub>	1.5	3.5	5.3	1.5	5.3	
t <sub>PLH</sub>	Propagation Delay	2.5	5.9	9.9	2.5	9.9	ns
t <sub>PHL</sub>	A <sub>n</sub> , B <sub>n</sub> to BPAR, APAR	2.5	5.8	9.9	2.5	9.9	
t <sub>PLH</sub>	Propagation Delay	2.5	5.4	9.4	2.5	9.4	ns
t <sub>PHL</sub>	A <sub>n</sub> , B <sub>n</sub> to $\overline{ERRA}$ , $\overline{ERRB}$	2.5	5.4	9.4	2.5	9.4	
t <sub>PLH</sub>	Propagation Delay	1.5	3.7	6.5	1.5	6.5	ns
t <sub>PHL</sub>	APAR, BPAR to $\overline{ERRA}$ , $\overline{ERRB}$	1.5	3.7	6.5	1.5	6.5	
t <sub>PLH</sub>	Propagation Delay	2.0	4.4	7.4	2.0	7.4	ns
t <sub>PHL</sub>	ODD/EVEN to APAR, BPAR	2.0	4.4	7.4	2.0	7.4	
t <sub>PLH</sub>	Propagation Delay	1.8	4.0	6.5	1.8	6.5	ns
t <sub>PHL</sub>	ODD/EVEN to $\overline{ERRA}$ , $\overline{ERRB}$	1.8	4.0	6.5	1.8	6.5	
t <sub>PLH</sub>	Propagation Delay	1.5	3.8	6.5	1.5	6.5	ns
t <sub>PHL</sub>	SEL to APAR, BPAR	1.5	3.8	6.5	1.5	6.5	
t <sub>PLH</sub>	Propagation Delay	1.5	3.2	5.1	1.5	5.1	ns
t <sub>PHL</sub>	LEA, LEB to B <sub>n</sub> , A <sub>n</sub>	1.5	3.2	5.1	1.5	5.1	
t <sub>PLH</sub>	Propagation Delay	2.5	5.9	9.2	2.5	9.2	ns
t <sub>PHL</sub>	LEA, LEB to BPAR, APAR Generate Mode	2.5	5.7	9.2	2.5	9.2	
t <sub>PLH</sub>	Propagation Delay	1.5	3.6	5.6	1.5	5.6	ns
t <sub>PHL</sub>	LEA, LEB to BPAR, APAR, Feed Thru Mode	1.5	3.6	5.6	1.5	5.6	
t <sub>PLH</sub>	Propagation Delay	1.6	5.4	8.9	1.6	8.9	ns
t <sub>PHL</sub>	LEA, LEB to $\overline{ERRA}$ , $\overline{ERRB}$	1.6	5.4	8.9	1.6	8.9	
t <sub>PZH</sub>	Output Enable Time	1.5	3.6	6.5	1.5	6.5	ns
t <sub>PZL</sub>	$\overline{GBA}$ or $\overline{GAB}$ to A <sub>n</sub> , APAR or B <sub>n</sub> , BPAR	1.5	3.4	6.5	1.5	6.5	
t <sub>PHZ</sub>	Output Disable Time	1.0	4.0	6.5	1.0	6.5	ns
t <sub>PLZ</sub>	$\overline{GBA}$ or $\overline{GAB}$ to A <sub>n</sub> , APAR or B <sub>n</sub> , BPAR	1.0	3.3	6.5	1.0	6.5	
t <sub>PLH</sub>	Propagation Delay	1.5	3.3	5.9	1.5	5.9	ns
t <sub>PHL</sub>	APAR to BPAR, BPAR to APAR	1.5	3.8	5.9	1.5	5.9	

AC Operating Requirements						
Symbol	Parameter	T <sub>A</sub> = +25°C V <sub>CC</sub> = +5.0V C <sub>L</sub> = 50 pF		T <sub>A</sub> = -40°C to +85°C V <sub>CC</sub> = 4.5V-5.5V C <sub>L</sub> = 50 pF		Units
		Min	Max	Min	Max	
t <sub>S</sub> (H)	Setup Time, HIGH or LOW A <sub>n</sub>	1.5		1.5		ns
t <sub>S</sub> (L)	APAR to LEA or B <sub>n</sub> , BPAR to LEB	1.5		1.5		
t <sub>H</sub> (H)	Hold Time, HIGH or LOW A <sub>n</sub>	1.0		1.0		ns
t <sub>H</sub> (L)	APAR to LEA or B <sub>n</sub> , BPAR to LEB	1.0		1.0		
t <sub>W</sub> (H)	Pulse Width, HIGH LEA or LEB	3.0		3.0		ns

Extended AC Electrical Characteristics									
(SOIC and PLCC Package)									
Symbol	Parameter	$T_A = +25^\circ\text{C}$ $V_{CC} = +5.0\text{V}$ $C_L = 50\text{ pF}$ 9 Outputs Switching (Note 9)			$T_A = -40^\circ\text{C to } +85^\circ\text{C}$ $V_{CC} = 4.5\text{V} - 5.5\text{V}$ $C_L = 250\text{ pF}$ 1 Output Switching (Note 10)		$T_A = -40^\circ\text{C to } +85^\circ\text{C}$ $V_{CC} = 4.5\text{V} - 5.5\text{V}$ $C_L = 250\text{ pF}$ 9 Outputs Switching (Note 11)		Units
		Min	Typ	Max	Min	Max	Min	Max	
$t_{\text{TOGGLE}}$	Max Toggle Frequency	100							MHz
$t_{\text{PLH}}$	Propagation Delay	1.5		6.2	2.0	7.2	2.5	9.5	ns
$t_{\text{PHL}}$	$A_n$ to $B_n$	1.5		6.2	2.0	7.2	2.5	9.5	
$t_{\text{PLH}}$	Propagation Delay	1.5		6.8	2.0	8.0	2.5	10.0	ns
$t_{\text{PHL}}$	APAR to BPAR	1.5		6.8	2.0	8.0	2.0	10.0	
$t_{\text{PLH}}$	Propagation Delay	2.5		10.0	3.0	12.5	3.5	13.5	ns
$t_{\text{PHL}}$	$A_n, B_n$ to BPAR, APAR	2.5		10.0	3.0	12.5	3.5	13.5	
$t_{\text{PLH}}$	Propagation Delay	(Note 13)			3.0	12.0	(Note 13)		ns
$t_{\text{PHL}}$	$A_n, B_n$ to $\overline{\text{ERRA}}, \overline{\text{ERRB}}$	(Note 13)			3.0	12.0	(Note 13)		
$t_{\text{PLH}}$	Propagation Delay	(Note 13)			2.0	9.0	(Note 13)		ns
$t_{\text{PHL}}$	APAR, BPAR to $\overline{\text{ERRA}}, \overline{\text{ERRB}}$	(Note 13)			2.0	9.0	(Note 13)		
$t_{\text{PLH}}$	Propagation Delay	(Note 13)			2.5	9.9	(Note 13)		ns
$t_{\text{PHL}}$	ODD/EVEN to APAR, BPAR	(Note 13)			2.5	9.9	(Note 13)		
$t_{\text{PLH}}$	Propagation Delay	(Note 13)			2.0	8.8	(Note 13)		ns
$t_{\text{PHL}}$	ODD/EVEN to $\overline{\text{ERRA}}, \overline{\text{ERRB}}$	(Note 13)			2.0	8.8	(Note 13)		
$t_{\text{PLH}}$	Propagation Delay	(Note 13)			2.0	9.5	(Note 13)		ns
$t_{\text{PHL}}$	SEL to APAR, BPAR	(Note 13)			2.0	9.5	(Note 13)		
$t_{\text{PLH}}$	Propagation Delay	1.5		5.7	2.0	7.9	2.5	10.0	ns
$t_{\text{PHL}}$	LEA, LEB to $B_n, A_n$	1.5		5.7	2.0	7.9	2.5	10.0	
$t_{\text{PLH}}$	Propagation Delay	1.5		9.5	2.0	12.0	2.5	13.0	ns
$t_{\text{PHL}}$	LEA, LEB to BPAR, APAR	1.5		9.5	2.0	12.0	2.5	13.0	
$t_{\text{PLH}}$	Propagation Delay	(Note 13)			2.0	11.5	(Note 13)		ns
$t_{\text{PHL}}$	LEA, LEB to $\overline{\text{ERRA}}, \overline{\text{ERRB}}$	(Note 13)			2.0	11.5	(Note 13)		
$t_{\text{PZH}}$	Output enable time	1.5		7.0	2.0	8.5	2.5	10.5	ns
$t_{\text{PZL}}$	$\overline{\text{GBA}}$ or $\overline{\text{GAB}}$ to $A_n$ , APAR or $B_n$ , BPAR	1.5		7.0	2.0	8.5	2.5	10.5	
$t_{\text{PHZ}}$	Output disable time	1.0		6.5					ns
$t_{\text{PLZ}}$	$\overline{\text{GBA}}$ or $\overline{\text{GAB}}$ to $A_n$ , APAR or $B_n$ , BPAR	1.0		6.5	(Note 12)		(Note 12)		

**Note 9:** This specification is guaranteed but not tested. The limits apply to propagation delays for all paths described switching in phase (i.e., all LOW-to-HIGH, HIGH-to-LOW, etc.).

**Note 10:** This specification is guaranteed but not tested. The limits represent propagation delay with 250 pF load capacitors in place of the 50 pF load capacitors in the standard AC load. This specification pertains to single output switching only.

**Note 11:** This specification is guaranteed but not tested. The limits represent propagation delays for all paths described switching in phase (i.e., all LOW-to-HIGH, HIGH-to-LOW, etc.) with 250 pF load capacitors in place of the 50 pF load capacitors in the standard AC load.

**Note 12:** The 3-STATE delay time is dominated by the RC network (500Ω, 250 pF) on the output and has been excluded from the datasheet.

**Note 13:** Not applicable for multiple output switching.

Extended AC Electrical Characteristics									
(SSOP Package)									
Symbol	Parameter	$T_A = +25^\circ\text{C}$ $V_{CC} = +5.0\text{V}$ $C_L = 50\text{ pF}$ 9 Outputs Switching (Note 14)			$T_A = -40^\circ\text{C to } +85^\circ\text{C}$ $V_{CC} = 4.5\text{V} - 5.5\text{V}$ $C_L = 250\text{ pF}$ 1 Output Switching (Note 15)		$T_A = -40^\circ\text{C to } +85^\circ\text{C}$ $V_{CC} = 4.5\text{V} - 5.5\text{V}$ $C_L = 250\text{ pF}$ 9 Outputs Switching (Note 16)		Units
		Min	Typ	Max	Min	Max	Min	Max	
$f_{\text{TOGGLE}}$	Max Toggle Frequency	100							MHz
$t_{\text{PLH}}$	Propagation Delay	1.5		6.7	2.0	7.7	2.5	10.1	ns
$t_{\text{PHL}}$	$A_n$ to $B_n$	1.5		6.7	2.0	7.7	2.5	10.1	
$t_{\text{PLH}}$	Propagation Delay	1.5		7.3	2.0	8.5	2.5	10.6	ns
$t_{\text{PHL}}$	APAR to BPAR	1.5		7.3	2.0	8.5	2.0	10.6	
$t_{\text{PLH}}$	Propagation Delay	2.5		10.7	3.0	13.2	3.5	14.3	ns
$t_{\text{PHL}}$	$A_n, B_n$ to BPAR, APAR	2.5		10.7	3.0	13.2	3.5	14.3	
$t_{\text{PLH}}$	Propagation Delay	(Note 18)			3.0	12.9	(Note 18)		ns
$t_{\text{PHL}}$	$A_n, B_n$ to $\overline{\text{ERRA}}, \overline{\text{ERRB}}$	(Note 18)			3.0	12.9	(Note 18)		
$t_{\text{PLH}}$	Propagation Delay	(Note 18)			2.0	9.5	(Note 18)		ns
$t_{\text{PHL}}$	APAR, BPAR to $\overline{\text{ERRA}}, \overline{\text{ERRB}}$	(Note 18)			2.0	9.5	(Note 18)		
$t_{\text{PLH}}$	Propagation Delay	(Note 18)			2.5	10.4	(Note 18)		ns
$t_{\text{PHL}}$	ODD/EVEN to APAR, BPAR	(Note 18)			2.5	10.4	(Note 18)		
$t_{\text{PLH}}$	Propagation Delay	(Note 18)			2.0	9.3	(Note 18)		ns
$t_{\text{PHL}}$	ODD/ $\overline{\text{EVEN}}$ to $\overline{\text{ERRA}}, \overline{\text{ERRB}}$	(Note 18)			2.0	9.3	(Note 18)		
$t_{\text{PLH}}$	Propagation Delay	(Note 18)			2.0	10.0	(Note 18)		ns
$t_{\text{PHL}}$	SEL to APAR, BPAR	(Note 18)			2.0	10.0	(Note 18)		
$t_{\text{PLH}}$	Propagation Delay	1.5		6.2	2.0	8.4	2.5	10.6	ns
$t_{\text{PHL}}$	LEA, LEB to $B_n, A_n$	1.5		6.2	2.0	8.4	2.5	10.6	
$t_{\text{PLH}}$	Propagation Delay	1.5		10.0	2.0	12.5	2.5	13.6	ns
$t_{\text{PHL}}$	LEA, LEB to BPAR, APAR	1.5		10.0	2.0	12.5	2.5	13.6	
$t_{\text{PLH}}$	Propagation Delay	(Note 18)			2.0	12.0	(Note 18)		ns
$t_{\text{PHL}}$	LEA, LEB to $\overline{\text{ERRA}}, \overline{\text{ERRB}}$	(Note 18)			2.0	12.0	(Note 18)		
$t_{\text{PZH}}$	Output enable time	1.5		7.5	2.0	9.0	2.5	11.1	ns
$t_{\text{PZL}}$	$\overline{\text{GBA}}$ or $\overline{\text{GAB}}$ to $A_n$ , APAR or $B_n$ , BPAR	1.5		7.5	2.0	9.0	2.5	11.1	
$t_{\text{PHZ}}$	Output disable time	1.0		7.0					ns
$t_{\text{PLZ}}$	$\overline{\text{GBA}}$ or $\overline{\text{GAB}}$ to $A_n$ , APAR or $B_n$ , BPAR	1.0		7.0	(Note 17)		(Note 17)		

**Note 14:** This specification is guaranteed but not tested. The limits apply to propagation delays for all paths described switching in phase (i.e., all LOW-to-HIGH, HIGH-to-LOW, etc.).

**Note 15:** This specification is guaranteed but not tested. The limits represent propagation delay with 250 pF load capacitors in place of the 50 pF load capacitors in the standard AC load. This specification pertains to single output switching only.

**Note 16:** This specification is guaranteed but not tested. The limits represent propagation delays for all paths described switching in phase (i.e., all LOW-to-HIGH, HIGH-to-LOW, etc.) with 250 pF load capacitors in place of the 50 pF load capacitors in the standard AC load.

**Note 17:** The 3-STATE delay time is dominated by the RC network (500Ω, 250 pF) on the output and has been excluded from the datasheet.

**Note 18:** Not applicable for multiple output switching.



<b>Skew</b>				
(PLCC package) (Note 2)				
Symbol	Parameter	$T_A = -40^\circ\text{C to }+85^\circ\text{C}$ $V_{CC} = 4.5\text{V} - 5.5\text{V}$ $C_L = 50\text{ pF}$ 9 Outputs Switching (Note 19)	$T_A = -40^\circ\text{C to }+85^\circ\text{C}$ $V_{CC} = 4.5\text{V} - 5.5\text{V}$ $C_L = 250\text{ pF}$ 9 Outputs Switching (Note 20)	Units
		Max	Max	
$t_{OSHL}$ (Note 21)	Pin to Pin Skew HL Transitions	1.0	2.0	ns
$t_{OSLH}$ (Note 21)	Pin to Pin Skew LH Transitions	1.1	2.1	ns
$t_{PS}$ (Note 22)	Duty Cycle LH-HL Skew	2.0	3.5	ns
$t_{OST}$ (Note 21)	Pin to Pin Skew LH/HL Transitions	2.0	3.5	ns
$t_{PV}$ (Note 23)	Device to Device Skew LH/HL Transitions	3.0	4.0	ns

**Note 19:** This specification is guaranteed but not tested. The limits apply to propagation delays for all paths described switching in phase (i.e., all LOW-to-HIGH, HIGH-to-LOW, etc.).

**Note 20:** This specification is guaranteed but not tested. The limits represent propagation delays with 250 pF load capacitors in place of the 50 pF load capacitors in the standard AC load.

**Note 21:** Skew is defined as the absolute value of the difference between the actual propagation delays for any two separate outputs of the same device. The specification applies to any outputs switching HIGH to LOW ( $t_{OSHL}$ ), LOW to HIGH ( $t_{OSLH}$ ), or any combination switching LOW to HIGH and/or HIGH to LOW ( $t_{OST}$ ). This specification is guaranteed but not tested. Skew applies to propagation delays individually; i.e.,  $A_n$  to  $B_n$  separate from  $LE_A$  to  $A_n$ .

**Note 22:** This describes the difference between the delay of the LOW-to-HIGH and the HIGH-to-LOW transition on the same pin. It is measured across all the outputs (drivers) on the same chip, the worst (largest delta) number is the guaranteed specification. This specification is guaranteed but not tested.

**Note 23:** Propagation delay variation for a given set of conditions (i.e., temperature and  $V_{CC}$ ) from device to device. This specification is guaranteed but not tested.

### Capacitance

Symbol	Parameter	Typ	Units	Conditions $T_A = 25^\circ\text{C}$
$C_{IN}$	Input Pin Capacitance	5.0	pF	$V_{CC} = 0\text{V}$
$C_{I/O}$ (Note 24)	Output Capacitance	11.0	pF	$V_{CC} = 5.0\text{V}$

**Note 24:**  $C_{I/O}$  is measured at frequency,  $f = 1\text{ MHz}$ , per MIL-STD-883B, Method 3012.

AC Path

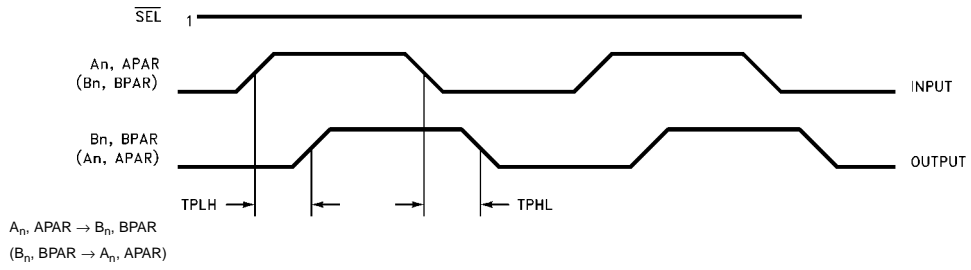

FIGURE 1.

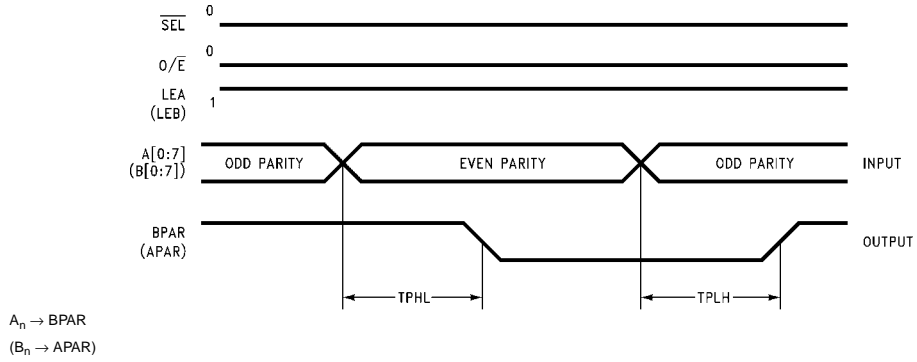

FIGURE 2.

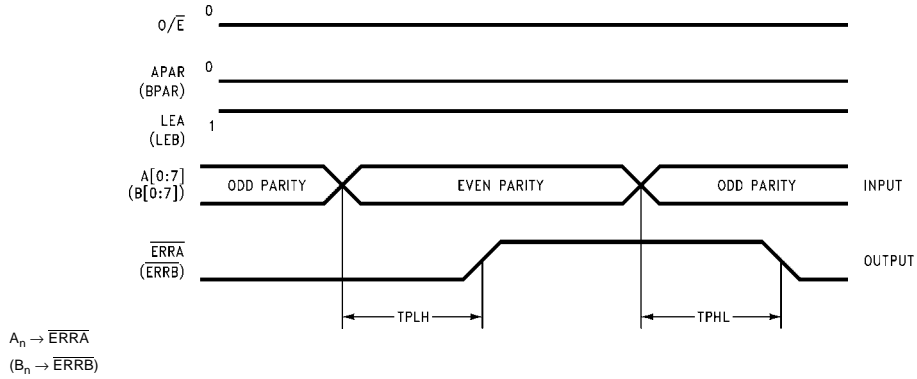

FIGURE 3.

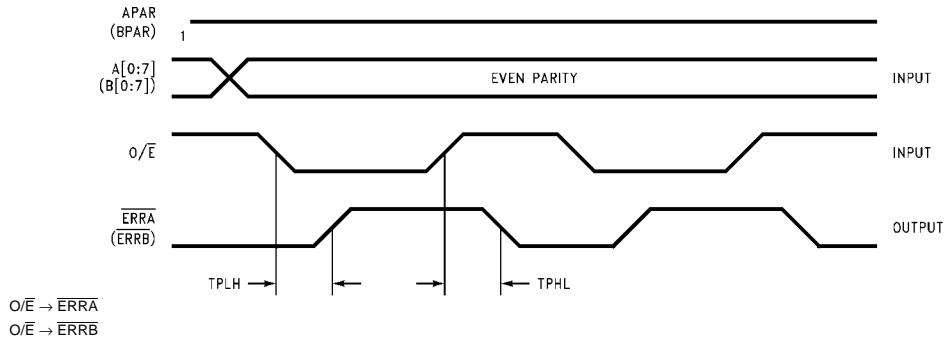

FIGURE 4.

AC Path (Continued)

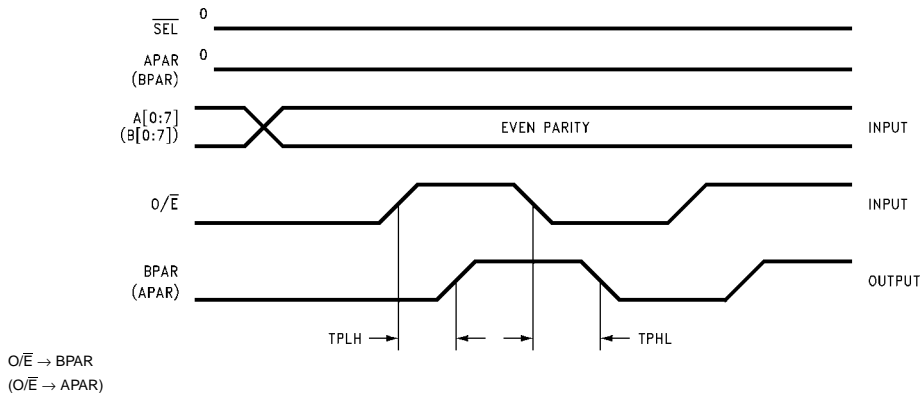

FIGURE 5.

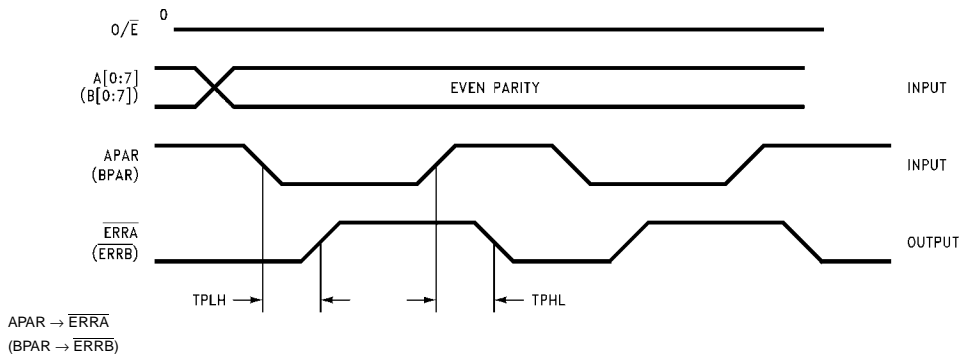

FIGURE 6.

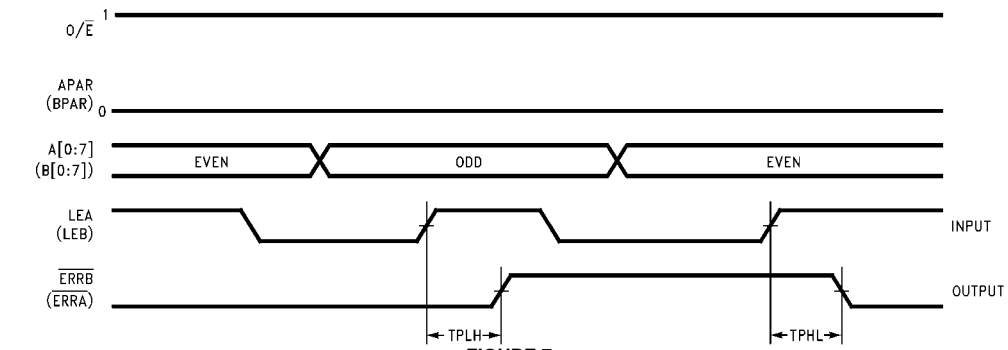

FIGURE 7.

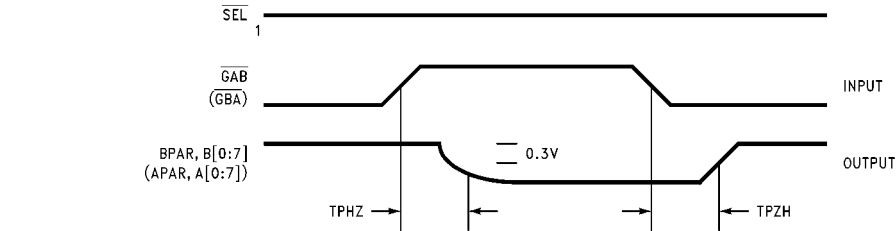

FIGURE 8.

ZH, HZ

AC Path (Continued)

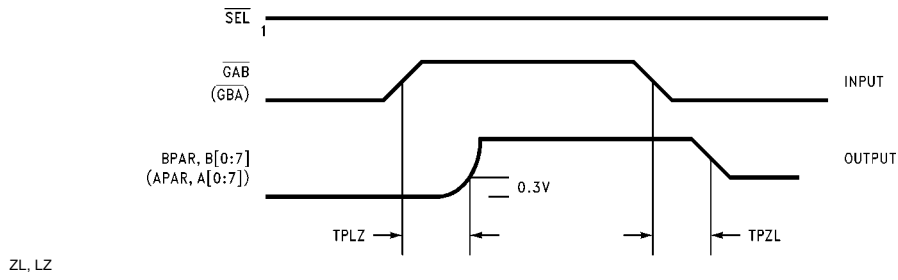

FIGURE 9.

ZL, LZ

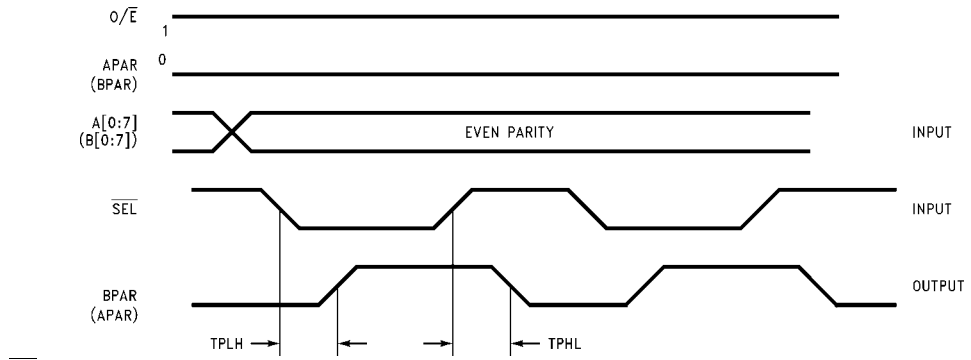

FIGURE 10.

$\overline{SEL} \rightarrow$  BPAR  
( $\overline{SEL} \rightarrow$  APAR)

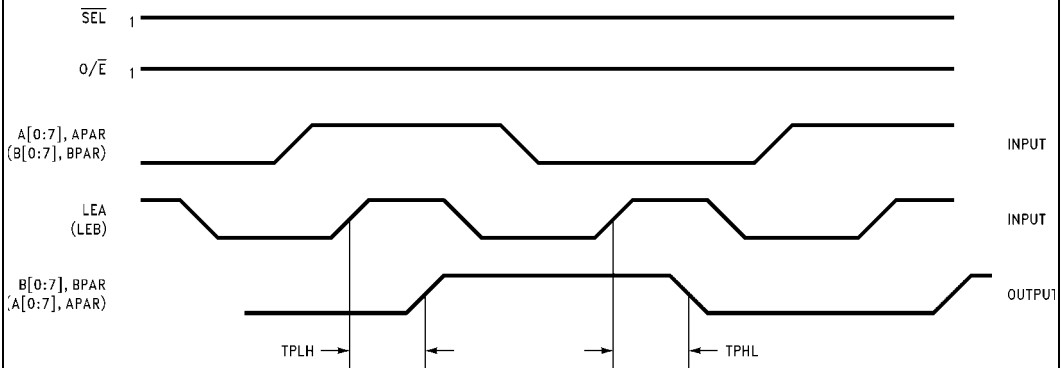

FIGURE 11.

LEA  $\rightarrow$  BPAR, B[0:7]  
(LEB  $\rightarrow$  APAR, A[0:7])

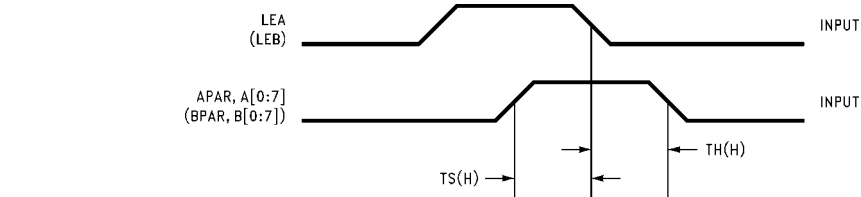
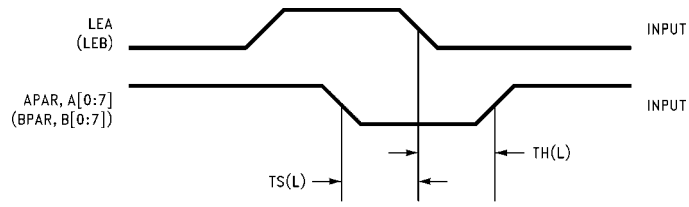

FIGURE 12.

TS(H), TH(H)  
LEA  $\rightarrow$  APAR, A[0:7]  
(LEB  $\rightarrow$  BPAR, B[0:7])

AC Path (Continued)



TS(L), TH(L)  
 LEA → APAR, A[0:7]  
 (LEB → BPAR, B[0:7])

FIGURE 13.

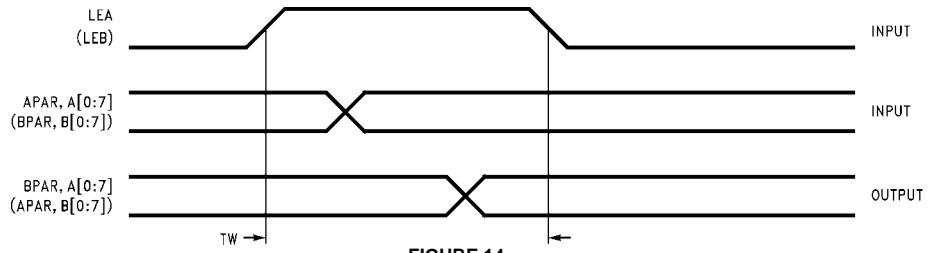
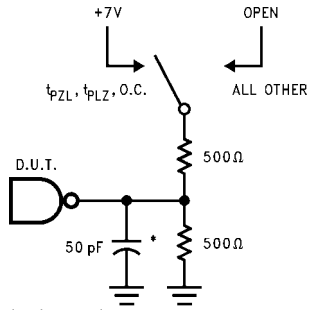

FIGURE 14.

### AC Loading



\*Includes jig and probe capacitance

FIGURE 15. Standard AC Test Load

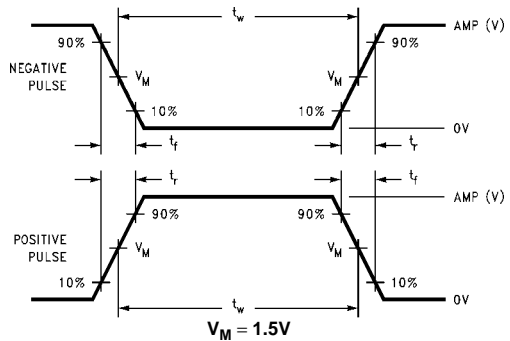

FIGURE 16.

### Input Pulse Requirements

Amplitude	Rep. Rate	$t_w$	$t_r$	$t_f$
3.0V	1 MHz	500 ns	2.5 ns	2.5 ns

FIGURE 17. Test Input Signal Requirements

### AC Waveforms

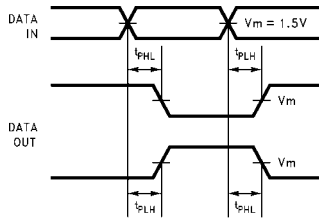

FIGURE 18. Propagation Delay Waveforms for Inverting and Non-Inverting Functions

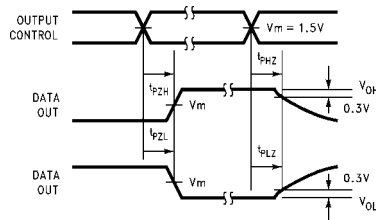

FIGURE 20. 3-STATE Output HIGH and LOW Enable and Disable Times

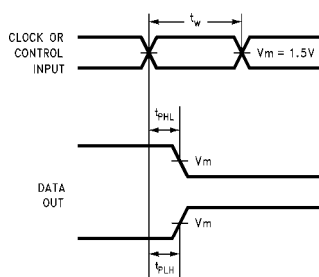

FIGURE 19. Propagation Delay, Pulse Width Waveforms

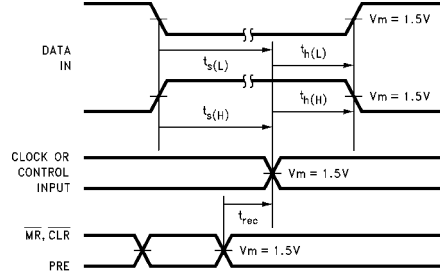
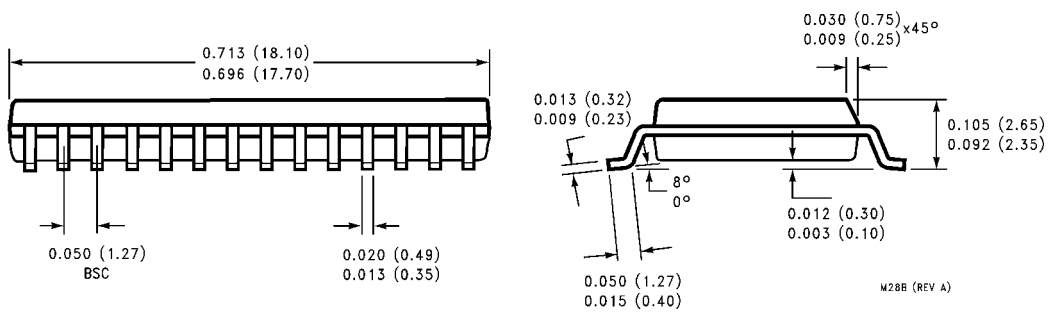
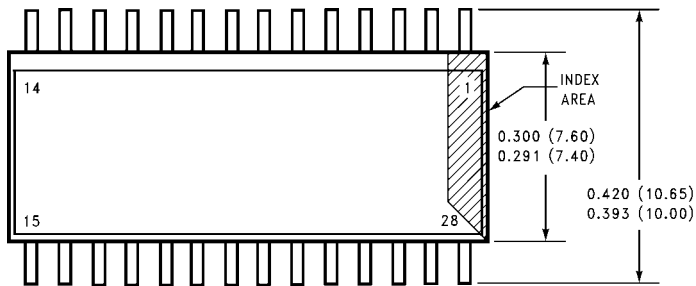
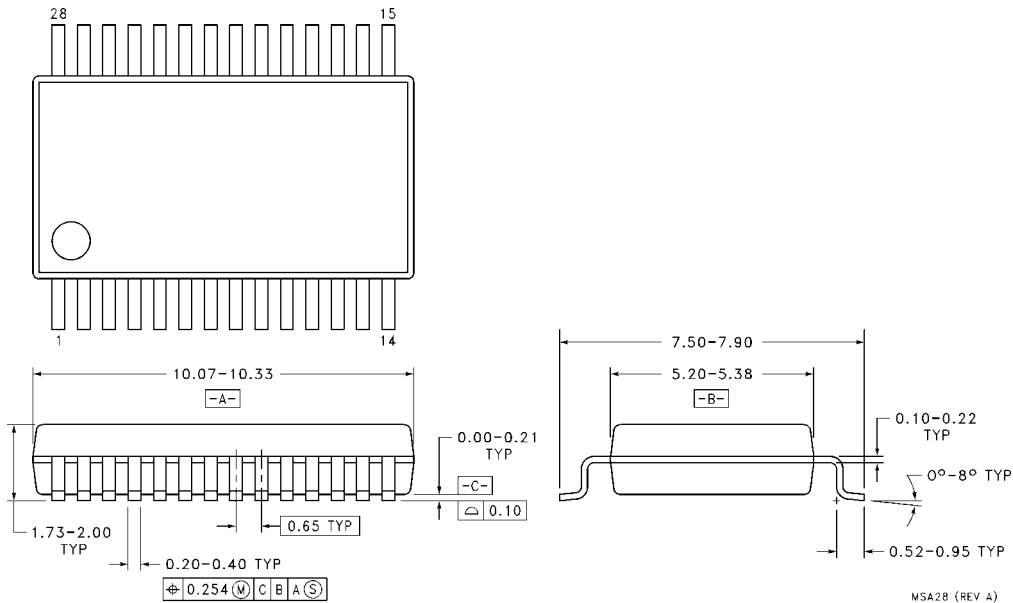

FIGURE 21. Setup Time, Hold Time and Recovery Time Waveforms

**Physical Dimensions** inches (millimeters) unless otherwise noted



**28-Lead Small Outline Integrated Circuit (SOIC), MS-013, 0.300" Wide Body  
Package Number M28B**



**28-Lead Shrink Small Outline Package (SSOP), EIAJ TYPE II, 5.3mm Wide  
Package Number MSA28**

**Physical Dimensions** inches (millimeters) unless otherwise noted (Continued)

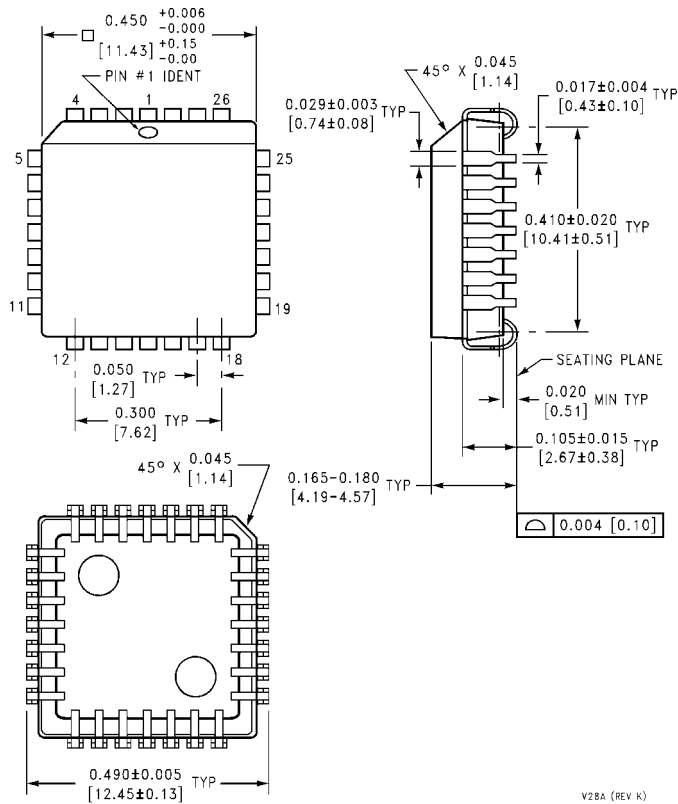

**28-Lead Plastic Lead Chip Carrier (PLCC), JEDEC MO-047, 0.450" Square Package Number V28A**

**LIFE SUPPORT POLICY**

FAIRCHILD'S PRODUCTS ARE NOT AUTHORIZED FOR USE AS CRITICAL COMPONENTS IN LIFE SUPPORT DEVICES OR SYSTEMS WITHOUT THE EXPRESS WRITTEN APPROVAL OF THE PRESIDENT OF FAIRCHILD SEMICONDUCTOR CORPORATION. As used herein:

1. Life support devices or systems are devices or systems which, (a) are intended for surgical implant into the body, or (b) support or sustain life, and (c) whose failure to perform when properly used in accordance with instructions for use provided in the labeling, can be reasonably expected to result in a significant injury to the user.
2. A critical component in any component of a life support device or system whose failure to perform can be reasonably expected to cause the failure of the life support device or system, or to affect its safety or effectiveness.

[www.fairchildsemi.com](http://www.fairchildsemi.com)