

DIALIGHT PART NO.	LED COLOR (nm)
598-8E20-102F,107F	RED ORANGE (625)
598-8E30-102F,107F	ORANGE (605)
598-8E40-102F,107F	YELLOW (590)
598-8E60-102F,107F	YELLOW GREEN (570)
598-8E80-102F,107F	GREEN (525)
598-8E90-102F,107F	BLUE (470)

REV	REVISIONS	DRN	APP	DATE
A	NEW RELEASE	LD	NO	9-24-19
B	ADDED DIM .039	LD	NO	11-13-19
C	P/N 598-8E10-102F,107F CHANGED TO 598-8E20-102F,107F, REMOVED I <sub>F</sub> VALUES UNDER FWD VOLTAGE	LD	NO	02-05-20

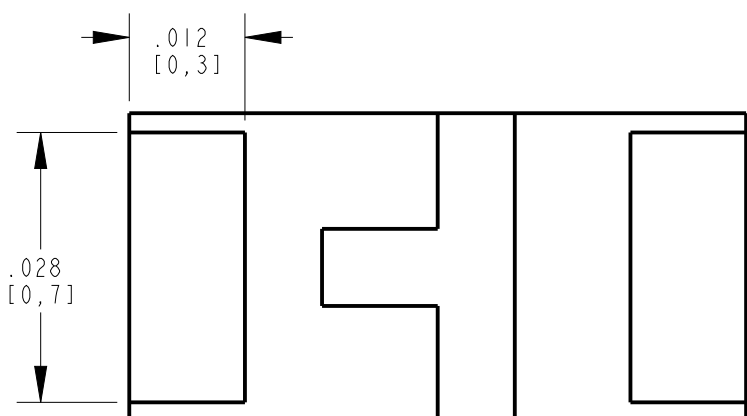

### RECOMMENDED PAD LAYOUT

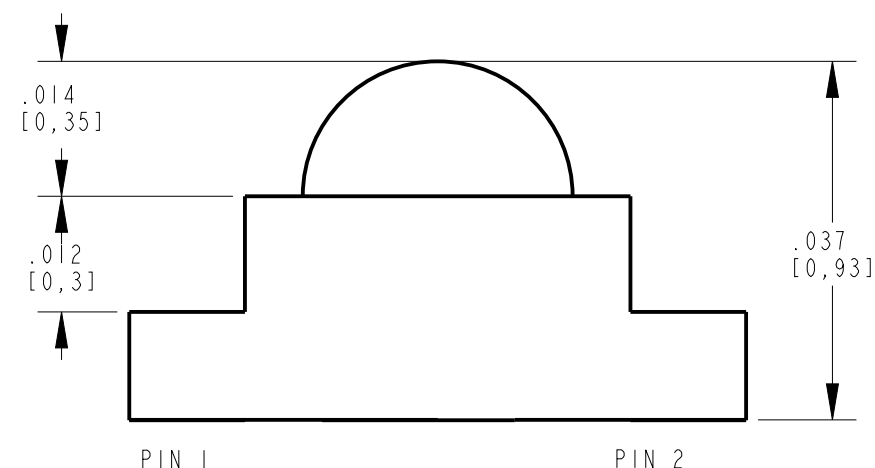
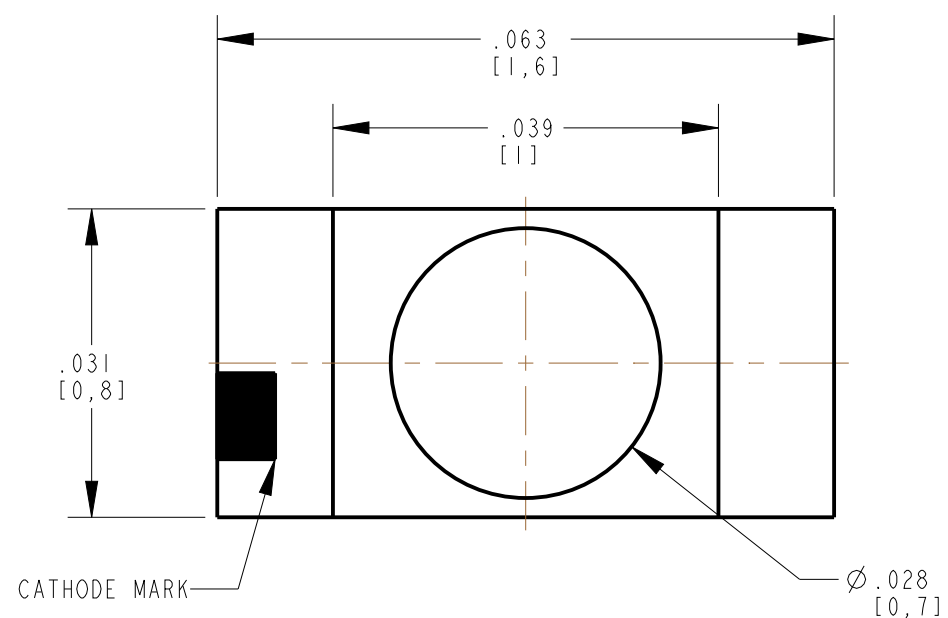
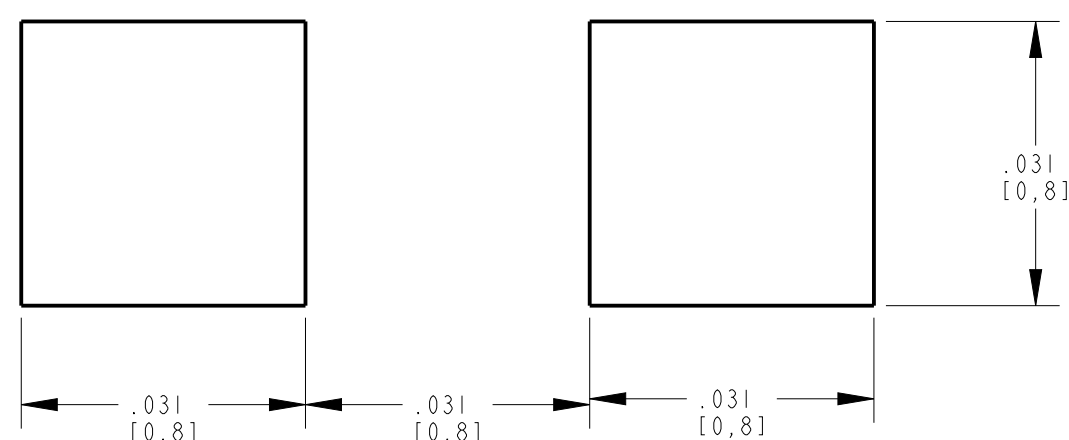

### NOTES:

1. QUANTITY IS 4,000 PCS PER REEL
2. PIN NUMBERS ARE FOR REFERENCE ONLY, DESIGNATION NON-EXISTENT ON PART.
3. THIS ASSEMBLY CONTAINS ELECTROSTATIC DISCHARGE SENSITIVE DEVICES (ESDS). MAINTAIN ALL PRECAUTIONARY MEASURES DURING ASSEMBLY, HANDLING AND STORAGE IN ACCORDANCE WITH IPC-A-610.
4. THIS PRODUCT IS RoHS COMPLIANT. EACH BAG IS TO BE MARKED WITH RoHS COMPLIANT LABEL OR EQUIVALENT MARKINGS. LED MUST BE Pb FREE.

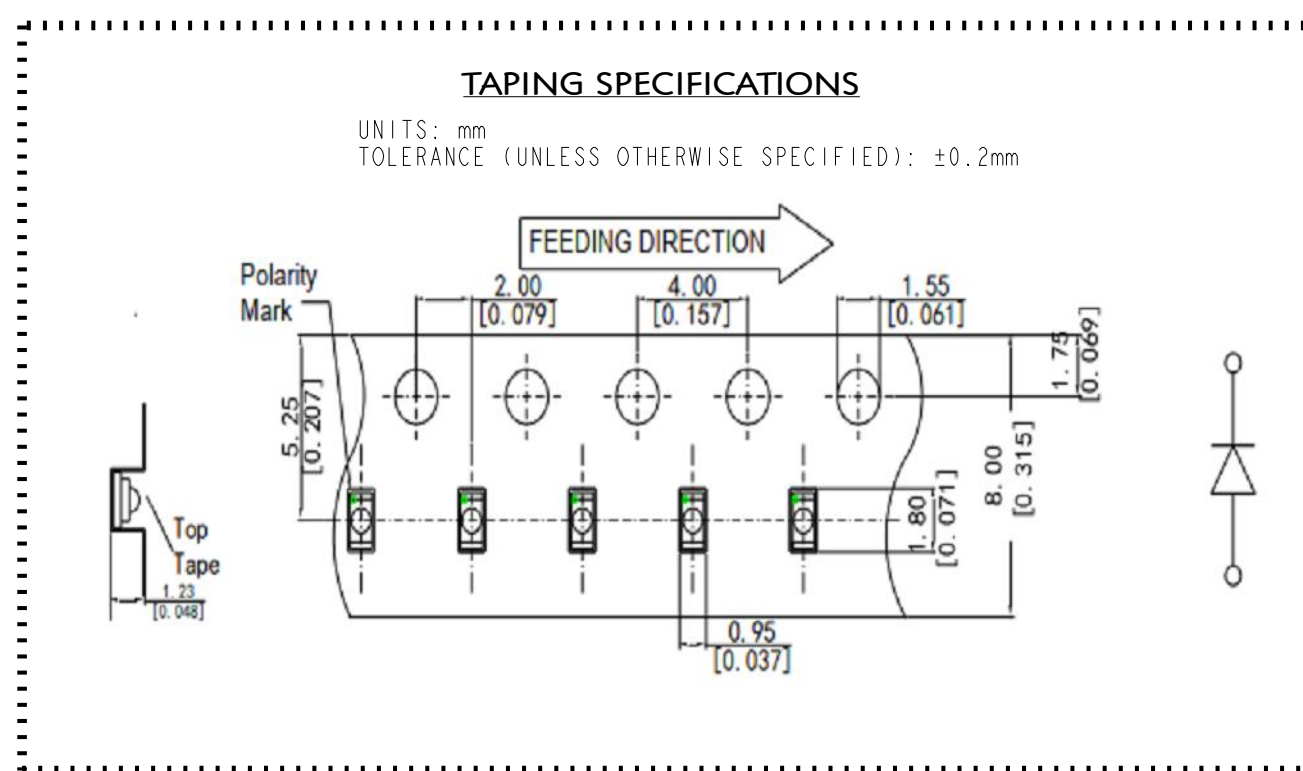

ELECTRICAL OPTICAL CHARACTERISTICS AT 25°C													
LED COLOR	TEST CONDITION	LUMINOUS INTENSITY (mcd)			DOMINANT WAVELENGTH (nm)			REVERSE CURRENT (uA)	SPECTRAL LINE HALF-WIDTH (nm)		FORWARD VOLTAGE (V)		VIEWING ANGLE (DEG)
		MIN.	TYP.	MAX.	MIN.	TYP.	MAX.	MAX	TYP	TYP.	MAX.	TYP	
RED ORANGE	I <sub>F</sub> (mA)	350	500	650	615	625	630	10	15	1.6	2.4	60	
ORANGE		430	615	800	600	605	610			1.6	2.4		
YELLOW		350	590	650	585	590	595			1.6	2.4		
YELLOW GREEN		150	340	530	565	570	575			1.8	2.4		
GREEN		350	775	1200	515	525	535			2.4	3.6		
BLUE		350	440	530	460	470	475			2.6	3.8		

ABSOLUTE MAXIMUM RATINGS AT 25°C							
LED COLOR	POWER DISSIPATION (mW)	FORWARD CURRENT (mA)	PEAK FORWARD CURRENT (mA)	ELECTROSTATIC DISCHARGE (V)	OPERATING TEMPERATURE (°C)	STORAGE TEMPERATURE (°C)	SOLDERING CONDITION (°C)
RED ORANGE	72	30	60	2000	-40 to +85	-40 to +85	260
ORANGE							
YELLOW							
YELLOW GREEN							
GREEN	108			1000			
BLUE	114						

### RECOMMENDED RoHS SOLDER PROFILE

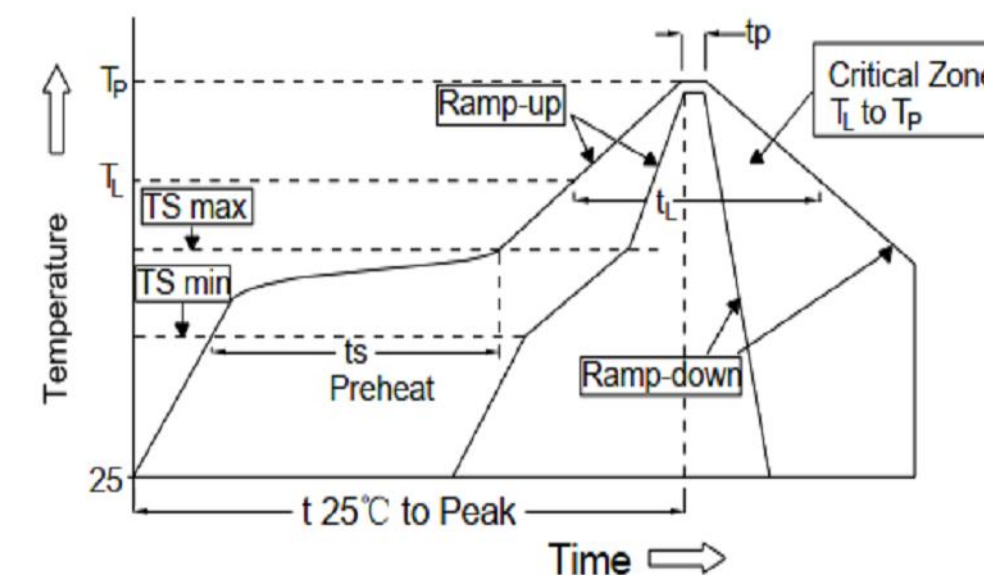

MARK	DEFINITION	CONDITION
TS <sub>max</sub>	Maximum of pre-heating temperature	200 °C
TS <sub>min</sub>	Minimum of pre-heating temperature	150 °C
T <sub>s</sub>	Time form T <sub>smin</sub> to T <sub>smax</sub>	60-120 sec
T <sub>L</sub>	Reference temperature	217 °C
t <sub>L</sub>	Retention time for TL	within 60s
T <sub>P</sub>	Peak Temperature	260 °C
t <sub>p</sub>	Time for peak temperature	within 10s
DTr/Dt	Temperature rising rate	under 6° C/sec
DTd/Dt	Temperature decreasing rate	under -3° C/sec

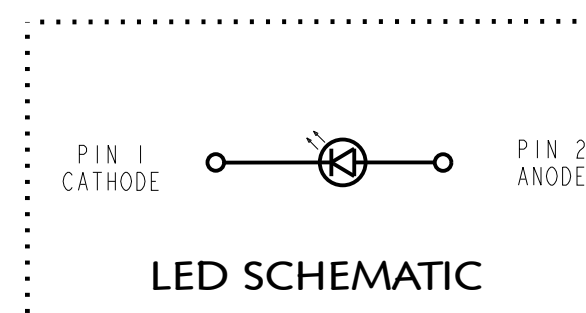

**ATTENTION:**  
OBSERVE PRECAUTIONS FOR  
HANDLING ELECTROSTATIC  
SENSITIVE DEVICES

THIS DRAWING AND THE CONTENTS HEREIN ARE CONFIDENTIAL AND THE SOLE PROPERTY OF DIALIGHT CORP. REPRODUCTION OF THIS DRAWING OR CONSTRUCTION OF ANY PARTS WITHIN THIS DRAWING ARE FORBIDDEN WITHOUT THE WRITTEN CONSENT OF DIALIGHT CORP.		
DIALIGHT CORP INTERNAL REFERENCE ONLY - 3D MODEL : 4500521848X15-A-1		
SCALE: 35.00	DRAWING NUMBER	REV
ALL DIM'S IN: INCHES (MM)	C18448	C
TOLERANCES: UNLESS OTHERWISE SPECIFIED	TITLE	
FRACTIONS: ±1/64	0603 W/ LENS	
DECIMALS (.XX): ±.01	MATERIAL	
DECIMALS (.XXX): ±.005		
DECIMALS (.XXXX): ±.0005		
ANGLES: ±1°		
FINISH	<b>Dialight</b>	
FSCM 83330	1501 ROUTE 34 SOUTH FARMINGDALE, NJ 07727 (732) 919-3119 www.dialight.com	
SHEET 1 OF 1	FAMILY TABLE:	