

System LXXX
LXXX 15.00/03/90 4.5SN BK BX

Weidmüller Interface GmbH & Co. KG
 Klingenbergstraße 16
 D-32758 Detmold
 Germany
 Fon: +49 5231 14-0
 Fax: +49 5231 14-2083
 www.weidmueller.com



The high-current PCB connection for more power on board:
 150 A /1000 V with wires up to 50 mm², transmitted right to the PCB!

The LXXX 15.0 – with its proven steel clamping-yoke technology in a compact standard housing – integrates the latest market requirements for security, power density and miniaturization in power electronics. It connects these requirements into an efficient solution for the entire value-creation chain – including development, production, installation and maintenance.

The function and form of the application's connection method plays a key role. It influences the application's design, reliability, usability and costs. With the Substitution of For example, with the replacement of complex constructions involving bolts or bus bars, the PCB can be transformed into a system platform that is both consistent and sustainable into the future – even for high-current applications.

The LXXX 15.0 reduces size and complexity while at the same time improving application integration. In so doing, it fulfils the requirements of power electronics better than the established mechanisms and connection elements.

General ordering data

Material number	1047140000
Short text for material	LXXX 15.00/03/90 4.5SN BK BX
Article - short description	PCB terminal, Clamping yoke connection, Solder connection, Clamping range, rated connection, max.: 50 mm ² , Pitch in mm: 15.00 mm, No. of poles: 3, 90°, Box
EAN	4032248784011
Qty.	10 pc(s).
Packaging	Box

System LXXX LXXX 15.00/03/90 4.5SN BK BX

Weidmüller Interface GmbH & Co. KG
Klingenbergstraße 16
D-32758 Detmold
Germany
Fon: +49 5231 14-0
Fax: +49 5231 14-2083
www.weidmueller.com

Technical data

Approvals

Approvals CSA; UR

System parameters

Product family	System LXXX	Conductor connection system	Clamping yoke connection
Fitted to PCB	Solder connection	Outgoing direction of conductor	90°
Pitch in mm	15 mm	Pitch in inch	0.591 inch
No. of poles	3	Fitted by customer	No
No. of rows	1	Solder pin length	4.5 mm
Diameter of solder eyelet	1.6 mm	Tolerance of the diameter of the solder eyelet	+ 0,1 mm
Number of solder pins per pole	4	Screwdriver blade	1.2 x 6.5
Screwdriver blade standard	DIN 5264	Tightening torque, min.	2.5 Nm
Tightening torque, max.	4 Nm	Clamping screw	M 6
Stripping length	18 mm	L1 in mm	30 mm
L1 in inch	1.181 inch		

Material data

Insulating material	Wemid (PA)	Colour	black
Flammability class UL 94	V-0	CTI	≥ 600
Contact material	Copper alloy	Contact surface	tinned
Contact base material	Copper alloy		

Connectable conductors

Clamping range, rated connection, min.	0.5 mm ²	Clamping range, rated connection, max.	50 mm ²
Conductor connection cross-section AWG, min.	AWG 20	Conductor connection cross-section AWG, max.	AWG 1
Solid, min. H05(07) V-U	0.5 mm ²	Solid, max. H05(07) V-U	16 mm ²
Stranded, max. H07V-R	50 mm ²	Stranded, min. H07V-R	6 mm ²
Flexible, min. H05(07) V-K	0.5 mm ²	Flexible, max. H05(07) V-K	35 mm ²
w. wire end ferrule, DIN 46228 pt 1, min.	0.5 mm ²	with wire end ferrule, DIN 46228 pt 1, max.	35 mm ²
w. plastic collar ferrule, DIN 46228 pt 4, min.	0.5 mm ²	with plastic collar ferrule, DIN 46228 pt 4, max.	35 mm ²

DIN IEC rating data

Rated current, min. No. of poles (Tu=20°C)	150 A	Rated current, no. of poles (Tu=40°C), min.	150 A
Rated voltage for overvoltage class/pollution severity II/2	1,000 V	Rated voltage for overvoltage class/pollution severity III/2	1,000 V
Rated voltage at overvoltage category/pollution degree III/3	1,000 V	Rated impulse withstand voltage for overvoltage class/pollution severity II/2	8 kV
Rated impulse withstand voltage for overvoltage class/pollution severity III/2	8 kV	Rated impulse withstand voltage for overvoltage class/pollution severity III/3	8 kV

CSA rating data

Rated voltage (Use group B)	600 V	Rated current (use group B)	127 A
Rated voltage (Use group C)	600 V	Rated current (use group C)	127 A
Rated voltage (use group D)	600 V	Rated current (use group D)	5 A
Wire cross-section, AWG, min.	AWG 20	Wire cross-section, AWG, max.	AWG 1

System LXXX LXXX 15.00/03/90 4.5SN BK BX

Weidmüller Interface GmbH & Co. KG
 Klingenbergstraße 16
 D-32758 Detmold
 Germany
 Fon: +49 5231 14-0
 Fax: +49 5231 14-2083
 www.weidmueller.com

Technical data

UL 1059 rating data

Rated voltage (use group B)	600 V	Rated current (use group B)	127 A
Rated voltage (use group C)	600 V	Rated current (use group C)	127 A
Rated voltage (use group D)	600 V	Rated current (use group D)	5 A
Wire cross-section, AWG, min.	AWG 20	Wire cross-section, AWG, max.	AWG 1

Classifications

ETIM 3.0	EC001284	ETIM 4.0	EC002643
eClass 6.0	27-26-11-01		

Notes

Notes	<ul style="list-style-type: none"> • Additional colours on request • Rated current related to rated cross-section and min. No. of poles. • Wire end ferrule without plastic collar to DIN 46228 pt 1 • Wire end ferrule with plastic collar to DIN 46228 pt 4 • P on drg. = pitch • Rated data refer only to the component itself. Clearance and creepage distances to other components are to be designed in accordance with the relevant application standards. • IP 20 from 16 mm² to 50 mm²
-------	--

System LXXX
LXXX 15.00/03/90 4.5SN BK BX

Weidmüller Interface GmbH & Co. KG
 Klingenbergstraße 16
 D-32758 Detmold
 Germany
 Fon: +49 5231 14-0
 Fax: +49 5231 14-2083
 www.weidmueller.com

Drawings

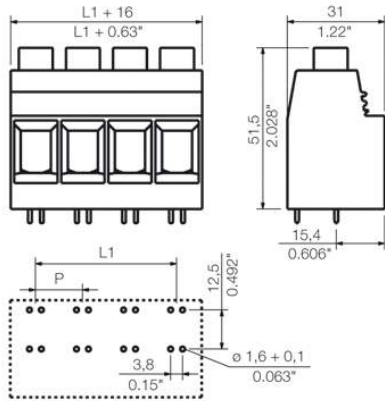

Derating curve

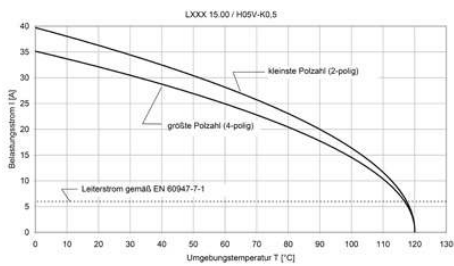

Derating curve

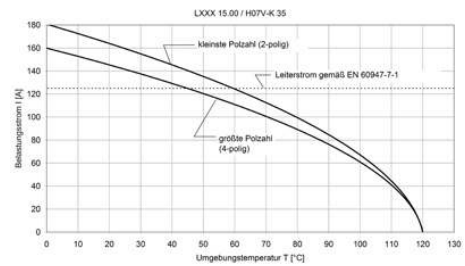

Derating curve

