

END-LOOK PACKAGE PIN PHOTO DIODE

● Features

1. Wide receiving angle
2. Linear response vs. irradiance
3. Fast switching time
4. End-looking Package ideal for space limited applications
5. Lens Appearance: Black
6. This product doesn't contain restriction substance, comply RoHS standard

● Description

The BPD-BQDA38V-FZ04 device consists of a PIN silicon photodiode molded in a black epoxy package which allows spectral response infrared light wavelengths. The wide receiving angle provides relatively even reception over a large area. The end-looking package is designed for easy PC board mounting. This photodiode is mechanically and spectrally matched to BRIGHT's GaAs and GaAlAs series of infrared emitting diodes.

● Absolute Maximum Ratings(Ta=25°C)

Parameter	Maximum Rating	Unit
Power Dissipation	100	mW
Reverse Breakdown Voltage	60V	
Operating Temperature	-40°C~+85°C	
Storage Temperature Range	-45°C~+85°C	
Lead Soldering Temperature	260°C for 5 seconds	

● Package Dimensions:

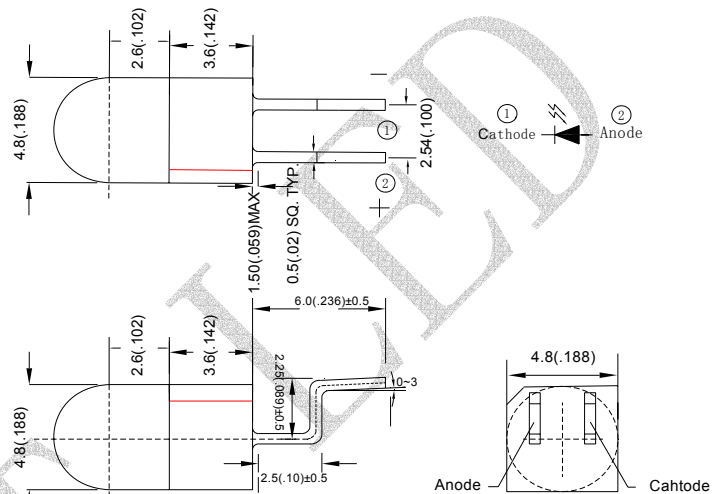

NOTES:

1. All dimensions are in millimeters (inches).
2. Tolerance is $\pm 0.25\text{mm}$ (0.01") unless otherwise specified.
3. Lead spacing is measured where the leads emerge from the package
4. Specifications are subject to change without notice

● **Electrical Characteristics** (TA=25°C unless otherwise noted)

PARAMETER	SYM BOL	MIN	TYP	MAX	UNITS	TEST CONDITIONS
Reverse Light Current	I_L	-	90		μA	$V_R=5V, E_e=1mW/cm^2$
Reverse Dark Current	I_D	-	-	100	nA	$V_R=10V, E_e=0 mW/cm^2$
Reverse Break down Voltage	$V_{(BR)}$	35	-	-	-	$I_R=100\mu A$
Forward Voltage	V_F	-	-	1.3	V	$I_F=10mA$
Total Capacitance	C_T	-	9	-	PF	$V_R=5V, E_e=0, f=1.0MHZ$
Rise Time/ Fall Time	tr/tf	-	50	-	ns	$V_R=20V, \lambda=940nm, RL=50\Omega$

● **Typical Optical-Electrical Characteristic Curves**

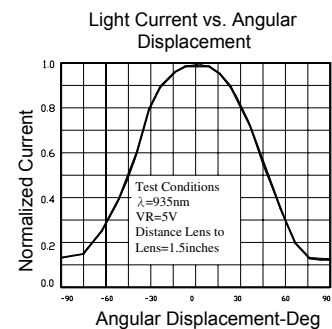
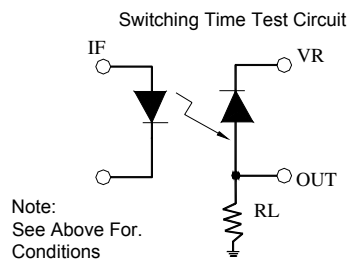
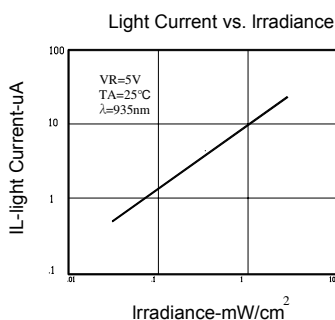
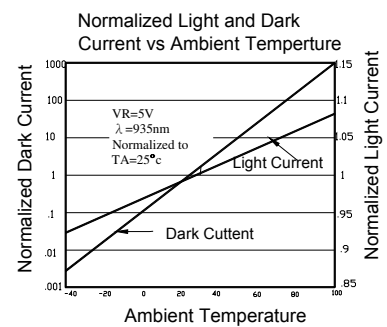
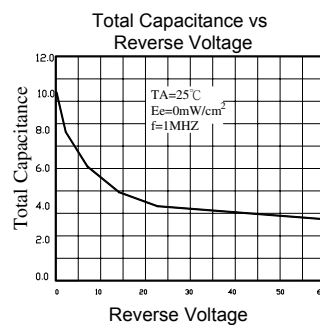
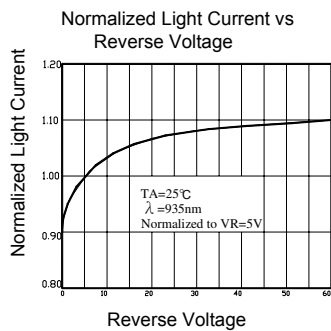
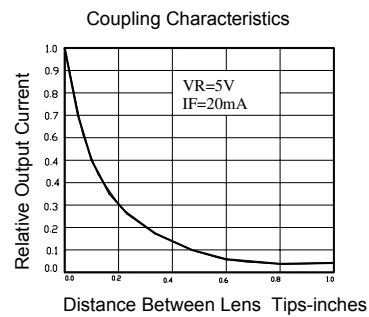
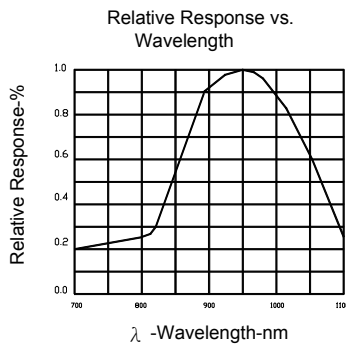

● Dip Soldering

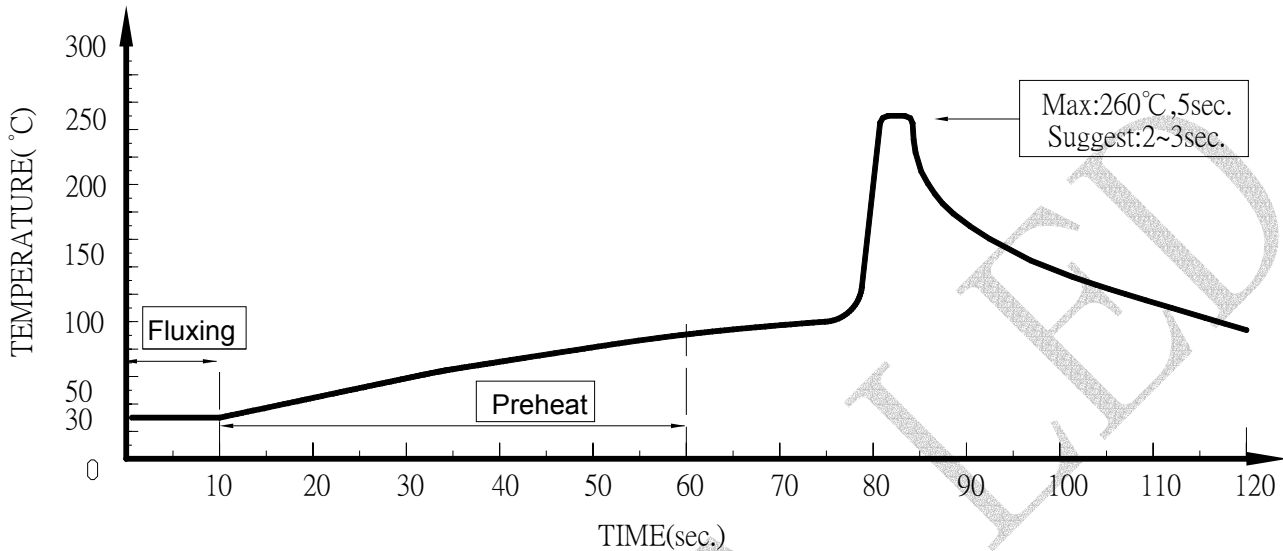

1. Please avoid any external stress applied to the lead-frames and epoxy while the LEDs are at high temperature, especially during soldering
2. DIP soldering and hand soldering should not be done more than one time.
3. After soldering, avoid the epoxy lens from mechanical shock or vibration until the LEDs are back to room temperature.
4. Avoid rapid cooling during temperature ramp-down process
5. Although the soldering condition is recommended above, soldering at the lowest possible temperature is feasible for the LEDs

● IRON Soldering

A: Max: 350°C Within 3 sec. One time only.

B: The products of 3mm without flange, welding condition of flat plate PCB Max: 350°C Within 2 sec. One time only

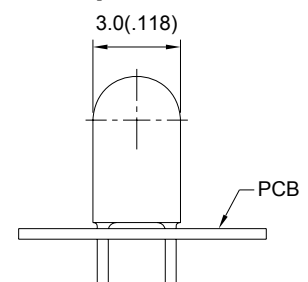

● Tapping and packaging specifications(Units: mm)

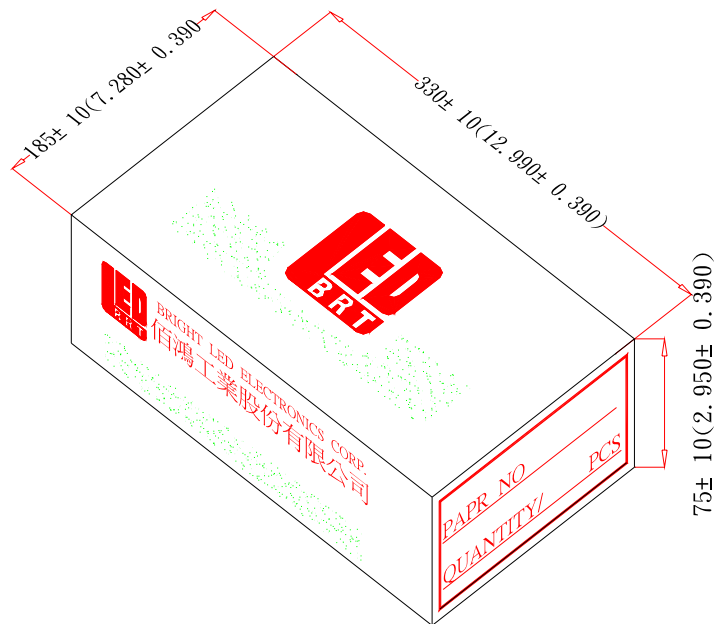

● Packaging Bag Dimensions

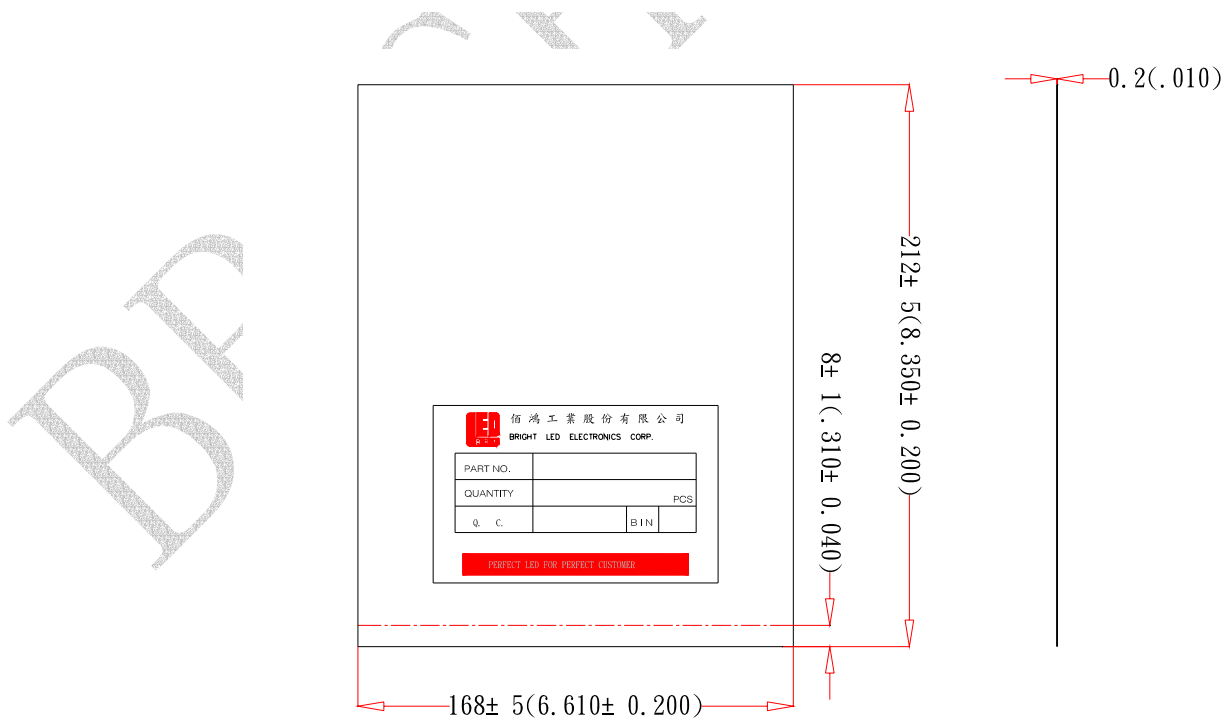

Notes:

- 1、500pcs per bag,5Kpcs per box.
- 2、All dimensions are in millimeters(inches).
- 3、Specifications are subject to change without notice.



Photodiode Specification

(Commodity: Photodiode

(Collector Current Bin Limits (IF=24mA Vce =5V)

BIN CODE	Min.(uA)	Max.(uA)
3	53	64
4	64	77
5	77	92
6	92	110
7	110	132

NOTES: Tolerance of measurement of Reverse Light Current :±15%