

APPROVED: \_\_\_\_\_  
 DATE: \_\_\_\_\_ TITLE: \_\_\_\_\_

Rev	AWO #	Description	Date	Appr
-		RELEASED	5/6/21	
A		RELEASED	5/24/21	LH/RC
B		ADDED PACKING	6/22/21	WX/RC
C		UPDATE PACKING DIM	11/11/21	LH/RC

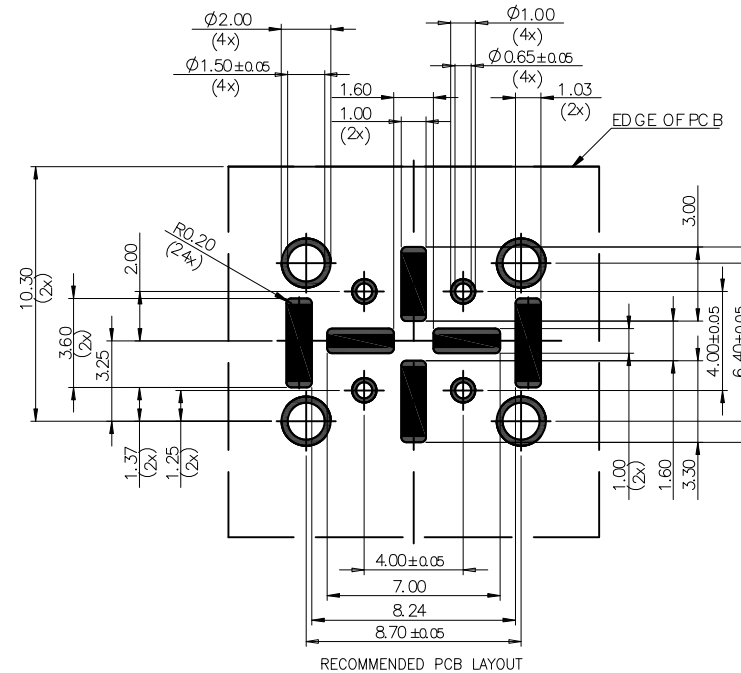

**SPECIFICATIONS:**  
 Material:  
 Insulator: Thermoplastic  
 Contacts: Brass  
 Shell: Zamak, Tin Plated  
 Contact Plating:  
 Contact area: 80-160u" Silver Plated  
 Solder tails area: 80-160u" Tin Plated  
 Underplate: 40-160u" Nickel underplate overall

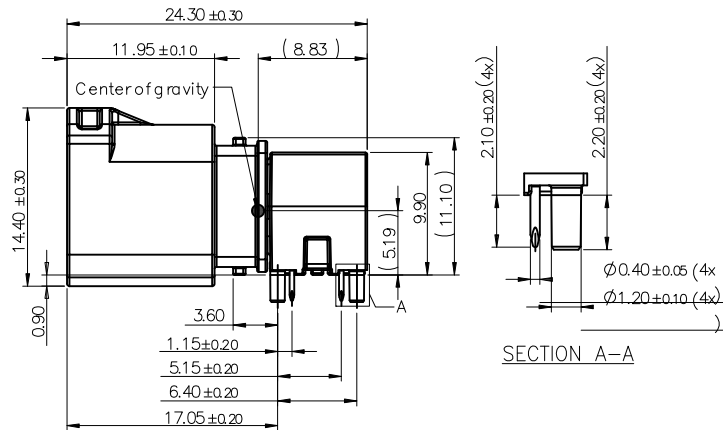
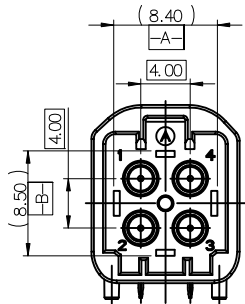
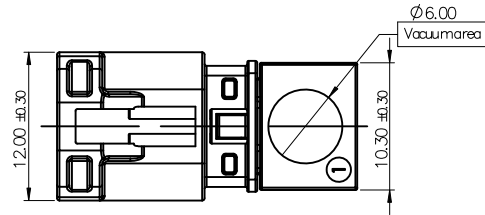
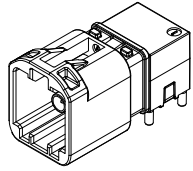
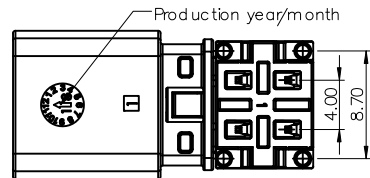

**Electrical:**  
 Impedance: 50Ω  
 Frequency: DC to 9 GHz  
 Return loss: ≥ 17 dB to 6 GHz  
 ≥ 12 dB to 9 GHz  
 Insertion loss: ≤ 0.75 dB @ 9 GHz  
 Insulation resistance: 1000 MΩ

**Mechanical:**  
 Mating Cycles: ≥ 25 Cycles  
 Engagement force: ≤ 30N  
 Disengagement force: ≥ 60N  
 Temperature Rating:  
 -40°C to +105°C  
 Environmental:  
 Lead free, RoHS compliant

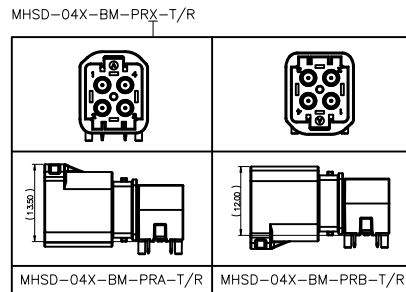

PACKAGED ON TAPE & REEL

UNLESS OTHERWISE SPECIFIED ALL DIMENSIONS ARE MILLIMETERS. TOLERANCES: EXCEPT AS NOTED		
X	MM ± 0.50	ANGLE ± 5°
.X	± 0.30	
.XX	± 0.20	
DRAWN	LH	5/6/21
CHECKED	RC	5/6/21
APPROVED		
THIS DRAWING CONTAINS INFORMATION THAT IS PROPRIETARY AND SHOULD NOT BE USED WITHOUT PRIOR WRITTEN PERMISSION FROM ADAM TECH		

**ADAM TECH** 909 Rahway Avenue, Union, NJ 07083  
 Phone: 908-687-5000 Fax: 908-687-5710

TITLE: **MINI FAKRA RIGHT ANGLE PLUG**

SIZE: X PART NO.: MHSD-04X-BM-PRX-T/R REV.: C

REF: S00013T SCALE: NTS SHEET 1 OF 4

6

5

4

3

2

1







APPROVED: \_\_\_\_\_

DATE: \_\_\_\_\_ TITLE: \_\_\_\_\_

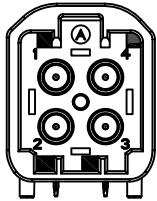
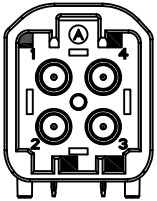
Rev	AWO #	Description	Date	Appr
-----	-------	-------------	------	------

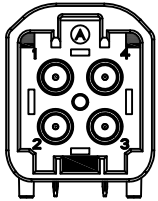
SEE SHT 1 OF 4 FOR REVISION

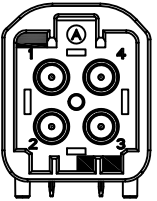
MHSD-04X-BM-PRX-T/R

Coding	A	B	C	D	E	F	Z
Plug							
Color	BLACK	WHITE	BLUE	CLARET VIOLET	GREEN	BROWN	WATER BLUE

UNLESS OTHERWISE SPECIFIED ALL DIMENSIONS ARE MILLIMETERS. TOLERANCES: EXCEPT AS NOTED

	MM	ANGLE
X.	± 0.50	± 5°
.X	± 0.30	
.XX	± 0.20	

**ADAM**  
**TECH**

909 Rahway Avenue,  
Union, NJ 07083  
Phone: 908-687-5000  
Fax: 908-687-5710

DRAWN	LH	5/6/21
CHECKED	RC	5/6/21
APPROVED		

TITLE		
MINI FAKRA RIGHT ANGLE PLUG		

THIS DRAWING CONTAINS INFORMATION THAT IS PROPRIETARY AND SHOULD NOT BE USED WITHOUT PRIOR WRITTEN PERMISSION FROM ADAM TECH

SIZE X	PART NO. MHSD-04X-BM-PRX-T/R	REV. C
REF: S00013T	SCALE: NTS	SHEET 2 OF 4

6

5

4

3

2

1

6

5

4

3

2

1

APPROVED: \_\_\_\_\_

DATE: \_\_\_\_\_ TITLE: \_\_\_\_\_

Rev	AWO #	Description	Date	Appr
-----	-------	-------------	------	------

SEE SHT 1 OF 4 FOR REVISION

D

D

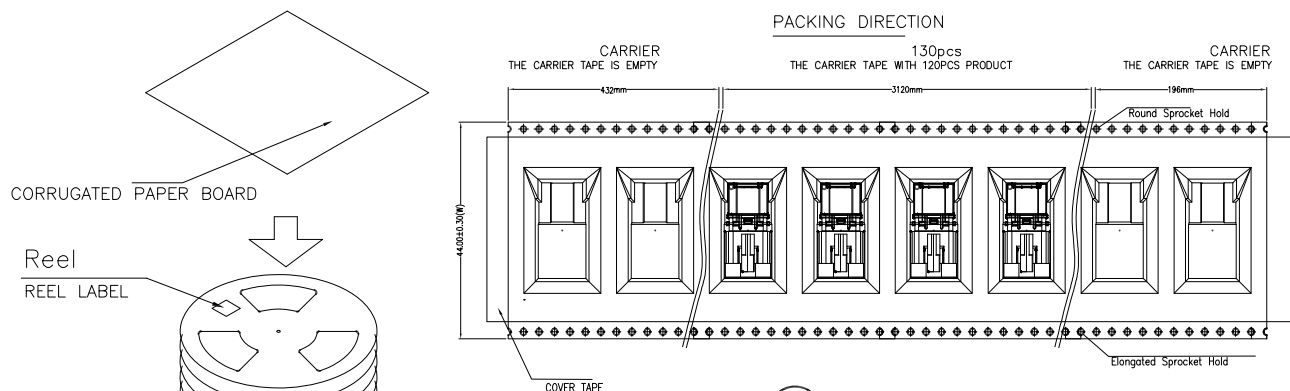

CORRUGATED PAPER BOARD

Reel  
REEL LABEL

DRYING AGENT

WATER PROOF BAG

C

C

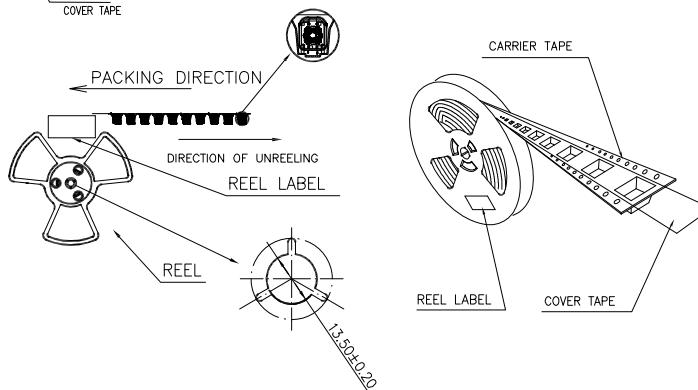

1. Fill in a corrugated paper board.
2. Put 4 triangle cylinder cardboard in all corner.
3. Put 5 reels of products into water proof bag, with 5pcs of drying agent.
4. Make all reel label side up.
5. Cover with corrugated paper board.
6. As the indication sticking the label at the certain place of carton.
7. Resistance value : 10'~10' □

B

B

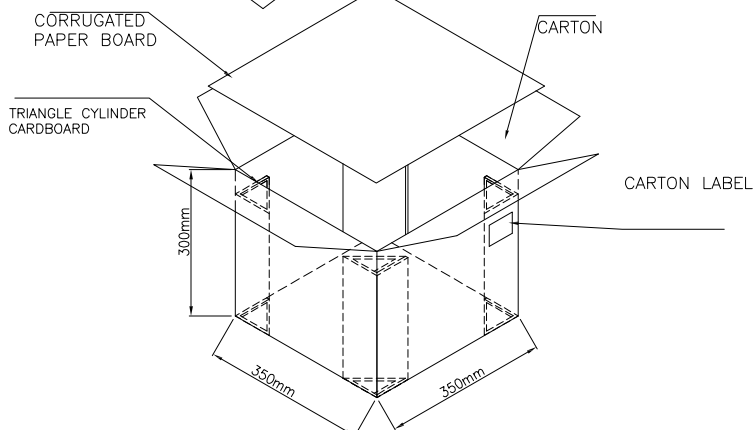

PCS/REEL: 130  
 REEL/CARTON: 5  
 CARTON/PCS: 650

A

A

NOTES

1. MATERIALS: PS (ESD)
  2. PACKING: TAPE REEL(130PCS/REEL,650PCS/CARTON)
  3. SONY SS-00259 or RoHS
- All Material in According With The RoHS Environment Related Substances List Controlled.

MHSD-04X-BM-PRA-TR

UNLESS OTHERWISE SPECIFIED ALL DIMENSIONS ARE MILLIMETERS. TOLERANCES: EXCEPT AS NOTED			<b>ADAM TECH</b> 909 Rahway Avenue, Union, NJ 07083 Phone: 908-687-5000 Fax: 908-687-5710	
X.	± 0.50	ANGLE		
.X	± 0.30			
.XX	± 0.20			
DRAWN	LH	5/6/21	TITLE	
CHECKED	RC	5/6/21	MINI FAKRA RIGHT ANGLE PLUG	
APPROVED			SIZE	PART NO.
THIS DRAWING CONTAINS INFORMATION THAT IS PROPRIETARY AND SHOULD NOT BE USED WITHOUT PRIOR WRITTEN PERMISSION FROM ADAM TECH			X	MHSD-04X-BM-PRX-T/R
			REV. C	
REF: S00013T	SCALE: NTS	SHEET 3 OF 4		

6

5

4

3

2

1

6

5

4

3

2

1

APPROVED: \_\_\_\_\_

DATE: \_\_\_\_\_ TITLE: \_\_\_\_\_

Rev	AWO #	Description	Date	Appr
-----	-------	-------------	------	------

SEE SHT 1 OF 4 FOR REVISION

D

D

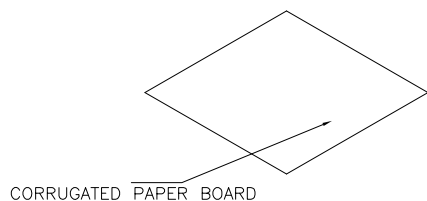

CORRUGATED PAPER BOARD

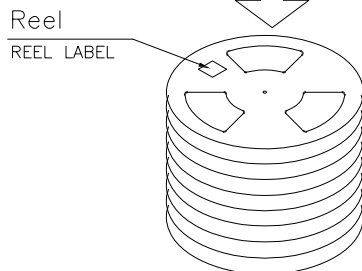

Reel

REEL LABEL

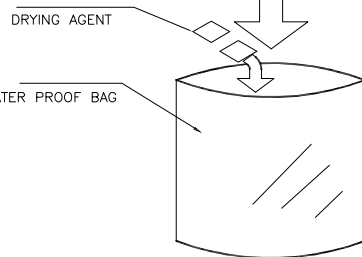

DRYING AGENT

WATER PROOF BAG

C

C

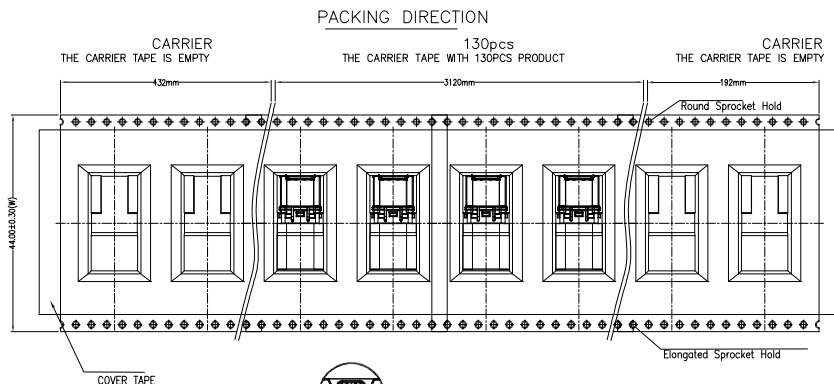

PACKING DIRECTION

CARRIER  
THE CARRIER TAPE IS EMPTY

130pcs  
THE CARRIER TAPE WITH 130PCS PRODUCT

CARRIER  
THE CARRIER TAPE IS EMPTY

432mm

3120mm

192mm

Round Sprocket Hold

Elongated Sprocket Hold

4600±0.30mm

COVER TAPE

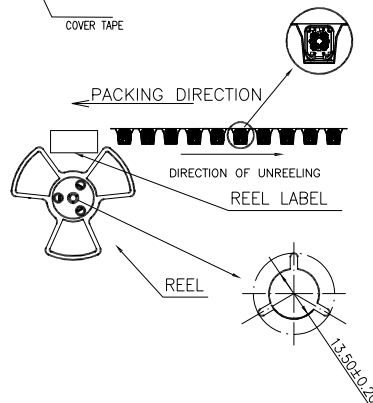

PACKING DIRECTION

DIRECTION OF UNREEING

REEL LABEL

REEL

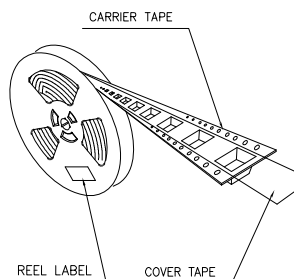

CARRIER TAPE

REEL LABEL

COVER TAPE

B

B

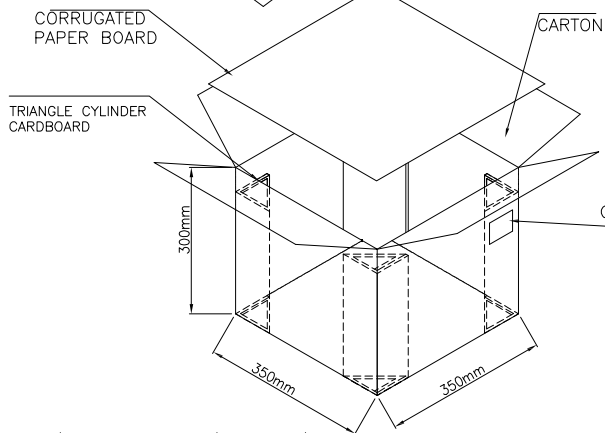

CORRUGATED PAPER BOARD

CARTON

TRIANGLE CYLINDER CARDBOARD

CARTON LABEL

300mm

350mm

350mm

MHSD-04X-BM-PRB-TR

A

A

NOTES

1. MATERIALS: PS (ESD)
  2. PACKING: TAPE REEL(130PCS/REEL,650PCS/CARTON)
  3. SONY SS-00259 or RoHS
- All Material in According With The RoHS Environment Related Substances List Controlled.

UNLESS OTHERWISE SPECIFIED ALL DIMENSIONS ARE MILLIMETERS. TOLERANCES: EXCEPT AS NOTED

	MM	ANGLE
X.	± 0.50	± 5°
.X	± 0.30	
.XX	± 0.20	

**ADAM TECH**

909 Rahway Avenue,  
Union, NJ 07083  
Phone: 908-687-5000  
Fax: 908-687-5710

DRAWN	LH	5/6/21
CHECKED	RC	5/6/21
APPROVED		

TITLE		REV.
MINI FAKRA RIGHT ANGLE PLUG		C
SIZE	PART NO.	
X	MHSD-04X-BM-PRX-T/R	

THIS DRAWING CONTAINS INFORMATION THAT IS PROPRIETARY AND SHOULD NOT BE USED WITHOUT PRIOR WRITTEN PERMISSION FROM ADAM TECH

REF:	S00013T	SCALE:	NTS	SHEET	4 OF 4
------	---------	--------	-----	-------	--------

6

5

4

3

2

1