

# CGH27015

15 W, 28 V, GaN HEMT for Linear Communications ranging from VHF to 3 GHz

## Description

WolfSpeed's CGH27015 is a gallium nitride (GaN) high electron mobility transistor designed specifically for high efficiency, high gain and wide bandwidth capabilities, which makes the CGH27015 ideal for VHF, Comms, 3G, 4G, LTE, 2.3-2.9 GHz WiMAX and BWA amplifier applications. The unmatched transistor is available in both screw-down, flange and solder-down, pill packages.

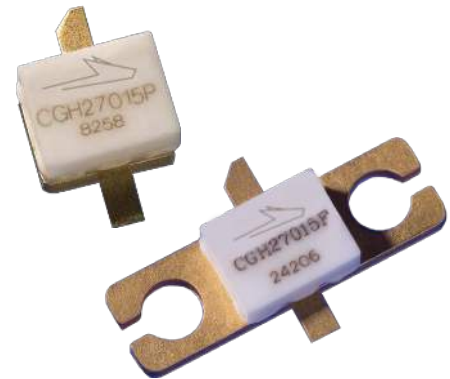

Package Types: 440166 and 440196  
PNs: CGH27015F and CGH27015P

## Typical Performance Over 2.3-2.7 GHz ( $T_c = 25^\circ\text{C}$ )

Parameter	2.3 GHz	2.4 GHz	2.5 GHz	2.6 GHz	2.7 GHz	Unit
Small Signal Gain	16.9	16.0	15.1	14.6	14.3	dB
EVM at $P_{AVE} = 33$ dBm	1.69	1.51	1.50	1.66	1.93	%
Drain Efficiency at $P_{AVE} = 33$ dBm	27.1	27.8	28.4	28.0	28.0	dB

### Notes:

<sup>1</sup> Measured in the CGH27015F-AMP amplifier circuit, under 802.16 OFDM, 3.5 MHz Channel BW, 1/4 Cyclic Prefix, 64 QAM Modulated Burst, 5ms Burst, Symbol Length of 59, Coding Type RS-CC, Coding Rate Type 2/3, PAR = 9.8 dB @ 0.01 % Probability on CCDF.

## Features

- VHF - 3.0 GHz Operation
- 15 W Peak Power Capability
- 14.5 dB Small Signal Gain
- 2 W  $P_{AVE} < 2.0\%$  EVM
- 28% Efficiency at 2 W Average Power
- Designed for WiMAX Fixed Access 802.16-2004 OFDM Applications
- Designed for WiMAX Mobile Access 802.16e OFDMA Applications







## Absolute Maximum Ratings (not simultaneous) at 25°C Case Temperature

Parameter	Symbol	Rating	Units	Conditions
Drain-Source Voltage	$V_{DSS}$	120	V	25°C
Gate-to-Source Voltage	$V_{GS}$	-10, +2		
Storage Temperature	$T_{STG}$	-65, +150	°C	
Operating Junction Temperature	$T_J$	225		
Maximum Forward Gate Current	$I_{GMAX}$	4.0	mA	25°C
Maximum Drain Current <sup>1</sup>	$I_{DMAX}$	1.5	A	
Soldering Temperature <sup>2</sup>	$T_S$	245	°C	
Screw Torque	$\tau$	40	in-oz	
Thermal Resistance, Junction to Case <sup>3</sup>	$R_{\theta JC}$	8.0	°C/W	85°C
Case Operating Temperature <sup>3</sup>	$T_C$	-40, +150	°C	

### Notes:

<sup>1</sup> Current limit for long term, reliable operation

<sup>2</sup> Refer to the Application Note on soldering at [wolfspeed.com/rf/document-library](http://wolfspeed.com/rf/document-library)

<sup>3</sup> Measured for the CGH27015F at  $P_{DISS} = 14$  W

## Electrical Characteristics ( $T_C = 25^\circ\text{C}$ )

Characteristics	Symbol	Min.	Typ.	Max.	Units	Conditions
<b>DC Characteristics<sup>1</sup></b>						
Gate Threshold Voltage	$V_{GS(th)}$	-3.8	-3.0	-2.3	$V_{DC}$	$V_{DS} = 10$ V, $I_D = 3.6$ mA
Gate Quiescent Voltage	$V_{GS(Q)}$	—	-2.7	—		$V_{DS} = 28$ V, $I_{DQ} = 100$ mA
Saturated Drain Current	$I_{DS}$	2.9	3.5	—	A	$V_{DS} = 6.0$ V, $V_{GS} = 2.0$ V
Drain-Source Breakdown Voltage	$V_{BR}$	84	—	—	$V_{DC}$	$V_{GS} = -8$ V, $I_D = 3.6$ mA
<b>RF Characteristics<sup>2,3</sup> (<math>T_C = 25^\circ\text{C}</math>, <math>F_0 = 2.5</math> GHz unless otherwise noted)</b>						
Small Signal Gain	$G_{SS}$	13	15	—	dB	$V_{DD} = 28$ V, $I_{DQ} = 100$ mA
Drain Efficiency <sup>4</sup>	$\eta$	20	28	—	%	$V_{DD} = 28$ V, $I_{DQ} = 100$ mA, $P_{AVE} = 33$ dBm
Error Vector Magnitude	EVM	—	2.0	—		
Output Mismatch Stress	VSWR	—	—	10 : 1	$\Psi$	No damage at all phase angles, $V_{DD} = 28$ V, $I_{DQ} = 100$ mA, $P_{AVE} = 33$ dBm OFDM $P_{AVE}$
<b>Dynamic Characteristics</b>						
Input Capacitance	$C_{GS}$	—	4.5	—	pF	$V_{DS} = 28$ V, $V_{GS} = -8$ V, $f = 1$ MHz
Output Capacitance	$C_{DS}$	—	1.3	—		
Feedback Capacitance	$C_{GD}$	—	0.2	—		

### Notes:

<sup>1</sup> Measured in the CGH27015F-AMP test fixture

<sup>2</sup> Scaled from PCM data

<sup>3</sup> Under 802.16 OFDM, 3.5 MHz Channel BW, 1/4 Cyclic Prefix, 64 QAM Modulated Burst, 5ms Burst, Symbol Length of 59, Coding Type RS-CC, Coding Rate Type 2/3

<sup>4</sup> Drain Efficiency =  $P_{OUT}/P_{DC}$



**Typical Performance Data**

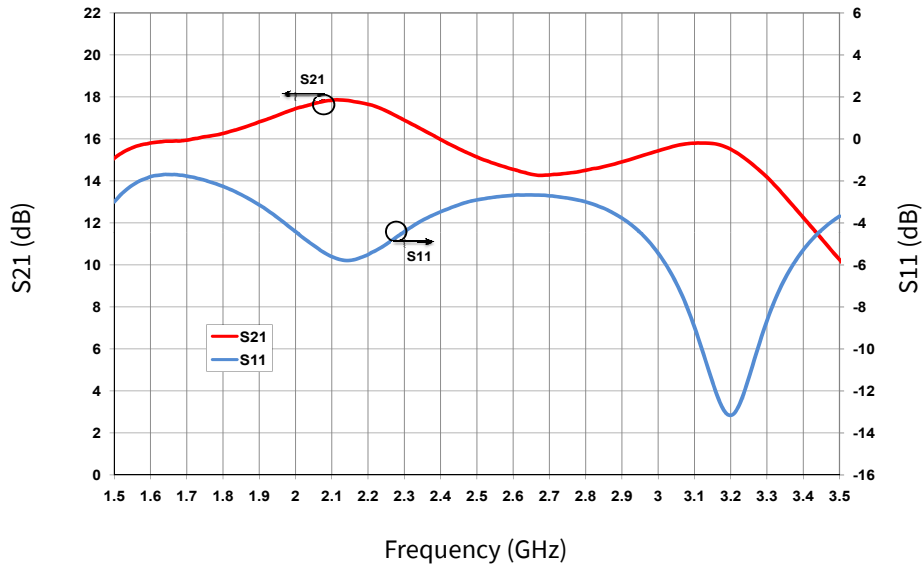

**Figure 1.** Performance of CGH27015 in Broadband Amplifier Circuit  
 $V_{DD} = 28\text{ V}$ ,  $I_{DQ} = 100\text{ mA}$

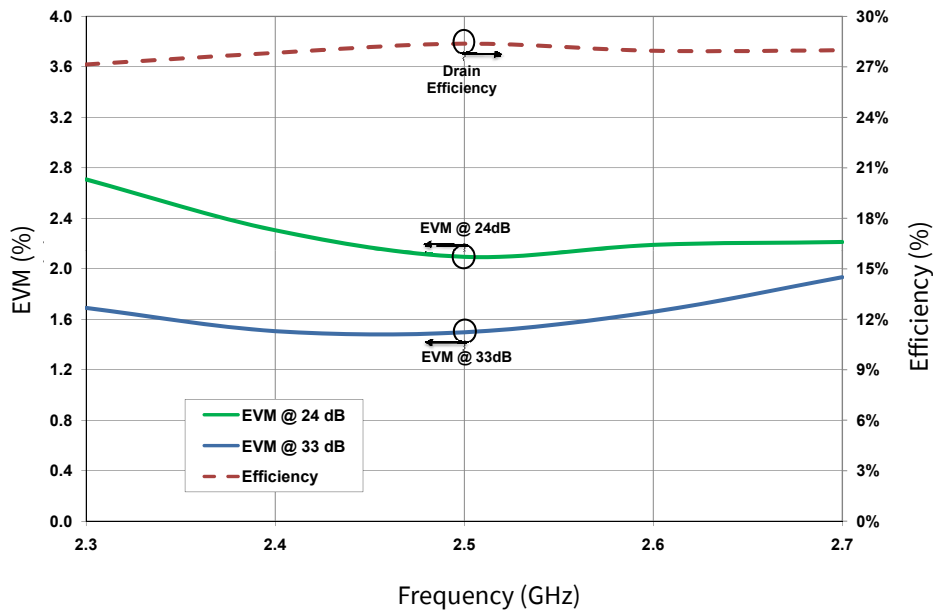

**Figure 2.** Typical EVM and Efficiency at 24 dBm and 33 dBm vs Frequency of CGH27015 in Broadband Amplifier Circuit

Note:

<sup>1</sup> Under 802.16 OFDM, 3.5 MHz Channel BW, 1/4 Cyclic Prefix, 64 QAM Modulated Burst, Symbol Length of 59, Coding Type RS-CC, Coding Rate Type 2/3.



Typical Performance Data

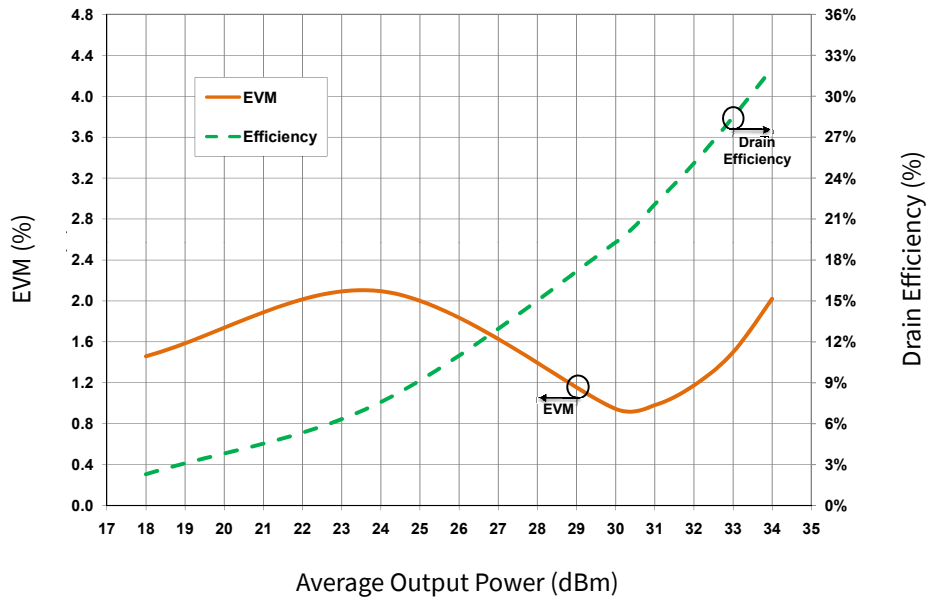

**Figure 3.** Typical EVM and Efficiency of CGH27015 in Broadband Amplifier Circuit at 2.5 GHz  
 $f = 2.5 \text{ GHz}$ , 802.16-2004 OFDM, P/A = 9.8 dB

Note:  
<sup>1</sup> Under 802.16-2004 OFDM, 3.5 MHz Channel BW, 1/4 Cyclic Prefix, 64 QAM Modulated Burst, Symbol Length of 59, Coding Type RS-CC, Coding Rate Type 2/3.

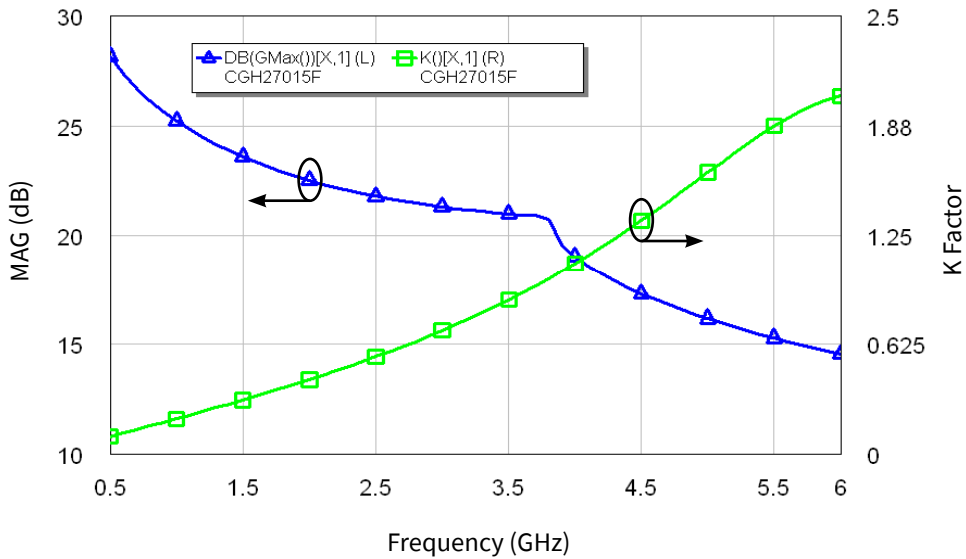

**Figure 4.** Simulated Maximum Available Gain and K Factor of the CGH27015F  
 $V_{DD} = 28 \text{ V}$ ,  $I_{DQ} = 100 \text{ mA}$



### Typical Noise Performance

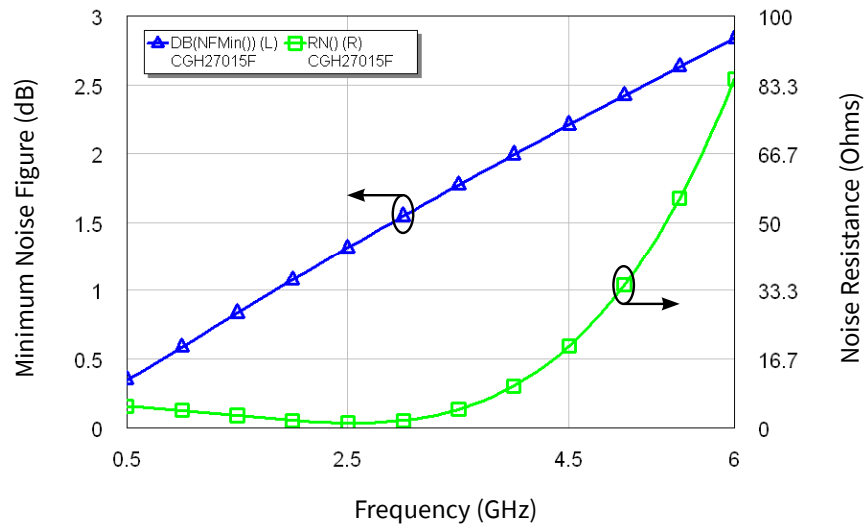
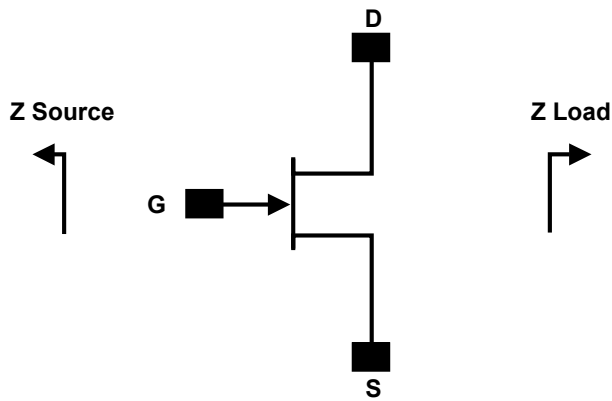

**Figure 5.** Simulated Minimum Noise Figure and Noise Resistance vs Frequency of the CGH27015  
 $V_{DD} = 28\text{ V}$ ,  $I_{DQ} = 100\text{ mA}$

### Electrostatic Discharge (ESD) Classifications

Parameter	Symbol	Class	Classification Level	Test Methodology
Human Body Model	HBM	TBD	ANSI/ESDA/JEDEC JS-001 Table 3	JEDEC JESD22 A114-D
Charge Device Model	CDM	TBD	ANSI/ESDA/JEDEC JS-002 Table 3	JEDEC JESD22 C101-C

### Source and Load Impedances



Frequency (MHz)	Z Source	Z Load
2300	17.8 - j1.5	16.8 - j1.7
2400	20.3 - j4.0	16.9 - j0.8
2500	20.6 - j7.9	17.2 + j0.2
2600	18.2 - j11.3	17.7 + j1.3
2700	14.6 - j12.6	19.1 + j2.4

Notes:

<sup>1</sup>  $V_{DD} = 28\text{ V}$ ,  $I_{DQ} = 200\text{ mA}$ . In the 440166 package

<sup>2</sup> Impedances are extracted from CGH27015-AMP demonstration circuit and are not source and load pull data derived from the transistor

### CGH27015 Power Dissipation De-rating Curve

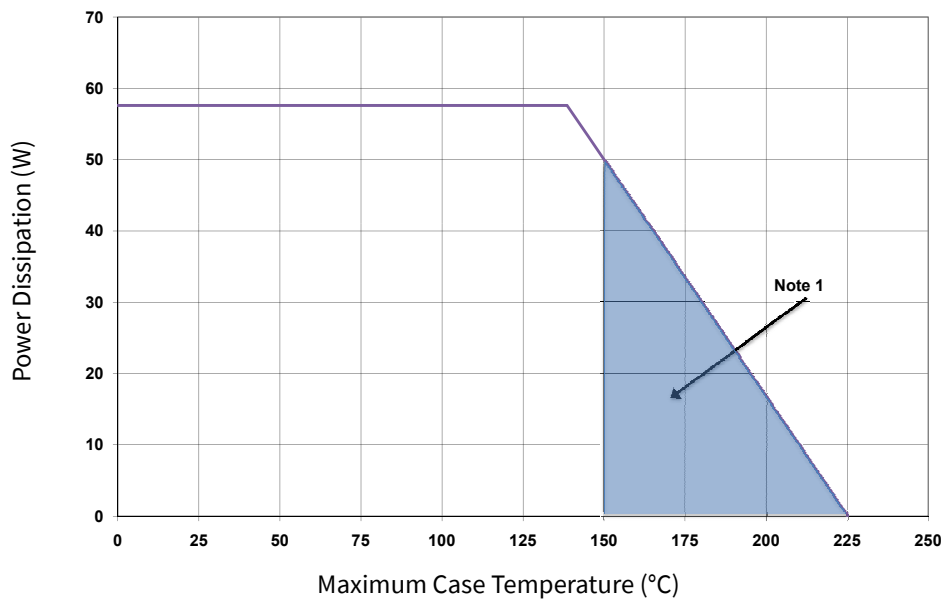

Note:

<sup>1</sup> Area exceeds Maximum Case Operating Temperature (See Page 2)



## CGH27015-AMP Demonstration Amplifier Circuit Bill of Materials

Designator	Description	Qty
R1, R2	RES, 1/16W, 0603, 1%, 0 OHMS	2
R4	RES, 1/16W, 0603, 1%, 100 OHMS	1
R3	RES, 1/16W, 0603, 1%, 22.6 OHMS	1
C6	CAP, 470pF, 5%, 100V, 0603	1
C17	CAP, 33 $\mu$ F, 20%, G CASE	1
C16	CAP, 1.0 $\mu$ F, 100V, 10%, X7R, 1210	1
C8	CAP, 10 $\mu$ F, 16V TANTALUM	1
C14	CAP, 100.0pF, +/-5%, 0603	1
C4	CAP, 15pF, +/-5%, 0603	1
C1	CAP, 1.8pF, +/-0.1pF, 0603	1
C2, C10, C11	CAP, 2.0pF, +/-0.1pF, 0603	3
C5, C13	CAP, 39pF, +/-5%, 0603	2
C7, C15	CAP, 33000pF, 0805, 100V, X7R	2
J3, J4	CONN SMA STR PANEL JACK RECP	1
J2	HEADER RT>PLZ.1CEN LK 2 POS	1
J1	HEADER RT>PLZ .1CEN LK 5POS	1
—	PCB, RO4350B, Er = 3.48, h = 20 mil	1
—	CGH27015F or CGH27015P	1

## CGH27015-AMP Demonstration Amplifier Circuit

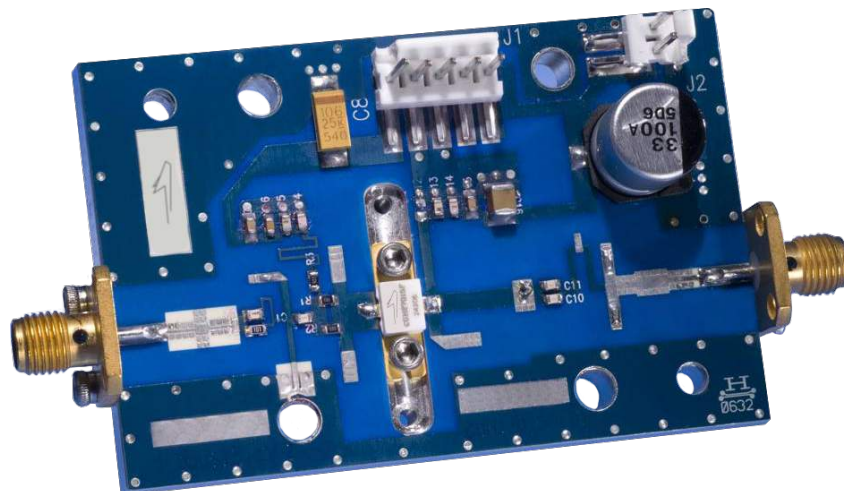



### CGH27015-AMP Demonstration Amplifier Circuit Schematic

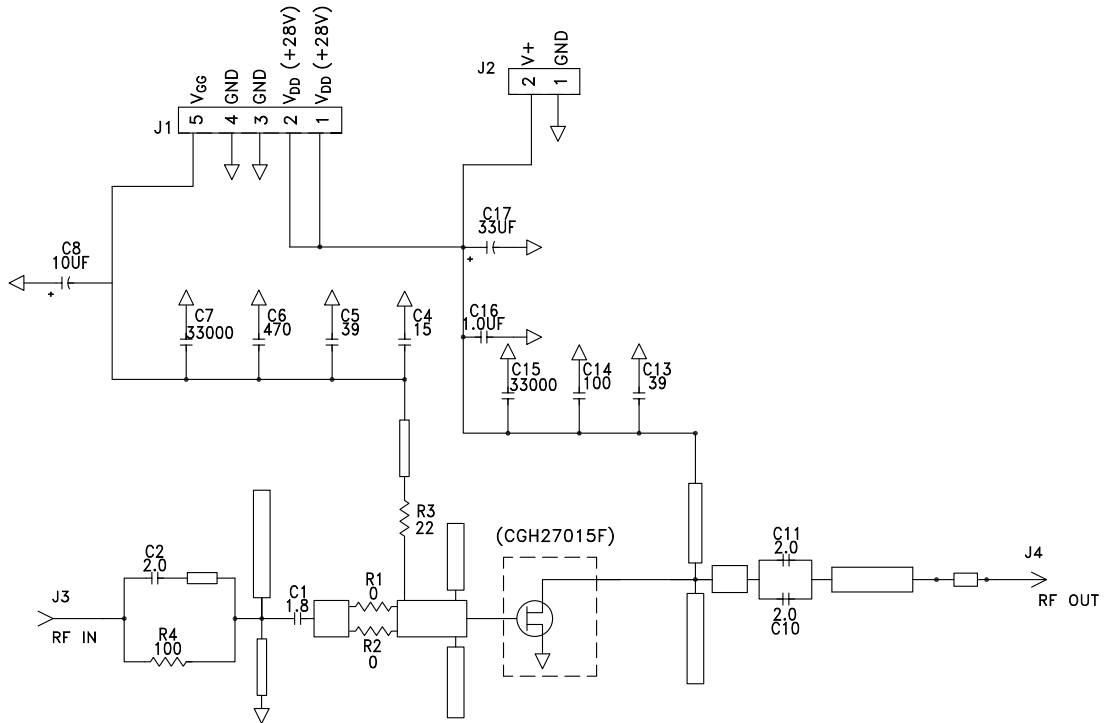

### CGH27015-AMP Demonstration Amplifier Circuit Outline

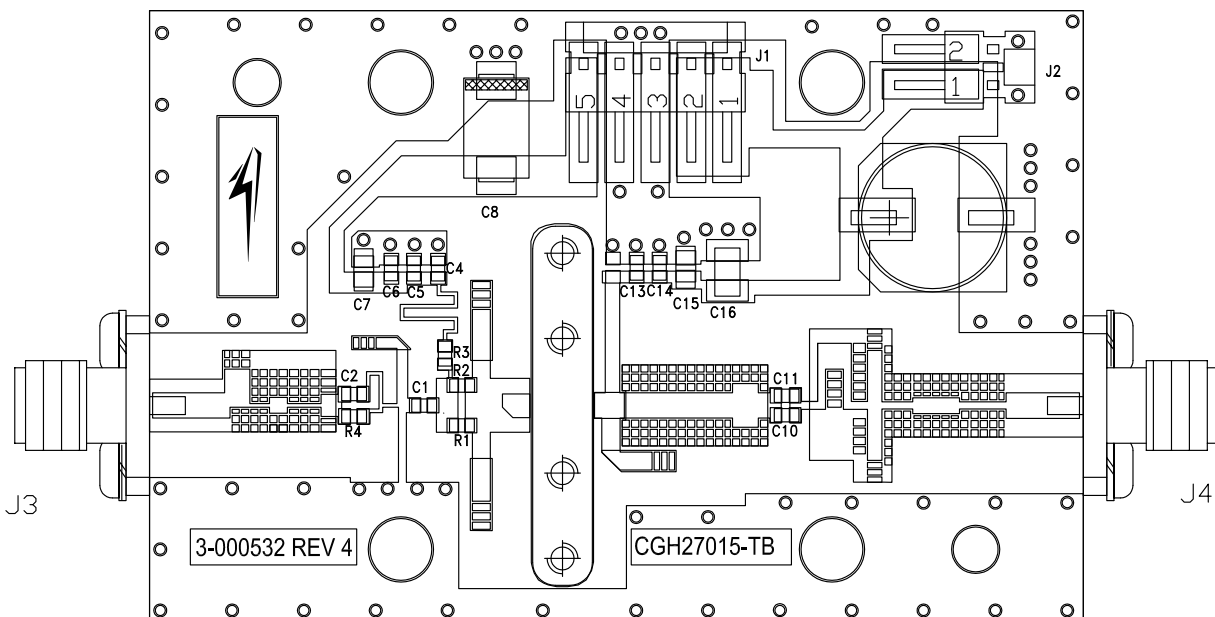





**Typical Package S-Parameters for CGH27015**  
 (Small Signal,  $V_{DS} = 28\text{ V}$ ,  $I_{DQ} = 100\text{ mA}$ , angle in degrees)

Frequency	Mag S11	Ang S11	Mag S21	Ang S21	Mag S12	Ang S12	Mag S22	Ang S22
500 MHz	0.909	-124.41	17.41	107.81	0.026	21.06	0.335	-93.73
600 MHz	0.902	-134.04	15.04	101.48	0.027	15.39	0.322	-101.61
700 MHz	0.898	-141.62	13.18	96.16	0.028	10.74	0.315	-107.78
800 MHz	0.894	-147.78	11.71	91.54	0.028	6.79	0.312	-112.73
900 MHz	0.892	-152.91	10.51	87.43	0.028	3.35	0.312	-116.77
1.0 GHz	0.890	-157.30	9.53	83.68	0.028	0.28	0.314	-120.15
1.1 GHz	0.889	-161.12	8.71	80.20	0.028	-2.51	0.318	-123.04
1.2 GHz	0.889	-164.51	8.01	76.95	0.028	-5.07	0.322	-125.57
1.3 GHz	0.888	-167.56	7.41	73.86	0.028	-7.45	0.328	-127.82
1.4 GHz	0.888	-170.34	6.89	70.91	0.028	-9.69	0.335	-129.87
1.5 GHz	0.888	-172.91	6.44	68.07	0.028	-11.81	0.342	-131.77
1.6 GHz	0.888	-175.30	6.04	65.32	0.028	-13.82	0.349	-133.56
1.7 GHz	0.888	-177.55	5.69	62.65	0.027	-15.74	0.357	-135.25
1.8 GHz	0.888	-179.68	5.37	60.05	0.027	-17.58	0.364	-136.89
1.9 GHz	0.888	178.29	5.09	57.50	0.027	-19.34	0.373	-138.48
2.0 GHz	0.888	176.34	4.83	55.01	0.027	-21.04	0.381	-140.03
2.1 GHz	0.889	174.45	4.60	52.56	0.026	-22.69	0.389	-141.55
2.2 GHz	0.889	172.63	4.39	50.14	0.026	-24.27	0.397	-143.06
2.3 GHz	0.889	170.84	4.20	47.76	0.026	-25.80	0.405	-144.56
2.4 GHz	0.889	169.10	4.02	45.41	0.025	-27.28	0.413	-146.04
2.5 GHz	0.890	167.39	3.86	43.09	0.025	-28.70	0.421	-147.52
2.6 GHz	0.890	165.71	3.71	40.79	0.025	-30.08	0.429	-149.00
2.7 GHz	0.891	164.04	3.57	38.51	0.024	-31.41	0.437	-150.48
2.8 GHz	0.891	162.39	3.44	36.26	0.024	-32.69	0.445	-151.95
2.9 GHz	0.891	160.76	3.32	34.01	0.024	-33.92	0.452	-153.43
3.0 GHz	0.892	159.13	3.21	31.79	0.023	-35.10	0.459	-154.92
3.2 GHz	0.892	155.89	3.00	27.38	0.023	-37.31	0.473	-157.90
3.4 GHz	0.893	152.65	2.83	23.00	0.022	-39.32	0.486	-160.90
3.6 GHz	0.893	149.39	2.67	18.66	0.021	-41.09	0.499	-163.93
3.8 GHz	0.894	146.09	2.54	14.34	0.020	-42.63	0.510	-166.99
4.0 GHz	0.894	142.74	2.41	10.02	0.020	-43.90	0.521	-170.10
4.2 GHz	0.895	139.33	2.31	5.70	0.019	-44.88	0.530	-173.24
4.4 GHz	0.895	135.84	2.21	1.37	0.018	-45.53	0.539	-176.45
4.6 GHz	0.895	132.26	2.12	-2.98	0.018	-45.84	0.547	-179.71
4.8 GHz	0.895	128.59	2.04	-7.36	0.017	-45.78	0.554	176.97
5.0 GHz	0.895	124.80	1.97	-11.79	0.016	-45.32	0.561	173.56
5.2 GHz	0.895	120.90	1.91	-16.27	0.016	-44.47	0.566	170.07
5.4 GHz	0.895	116.87	1.85	-20.81	0.016	-43.25	0.571	166.48
5.6 GHz	0.895	112.70	1.80	-25.41	0.015	-41.72	0.575	162.78
5.8 GHz	0.895	108.38	1.75	-30.10	0.015	-39.97	0.579	158.96
6.0 GHz	0.895	103.92	1.70	-34.88	0.016	-38.13	0.581	155.00

To download the s-parameters in s2p format, go to the [CGH27015 Product page](#) and click on the documentation tab.



**Product Dimensions CGH27015F (Package Type — 440166)**

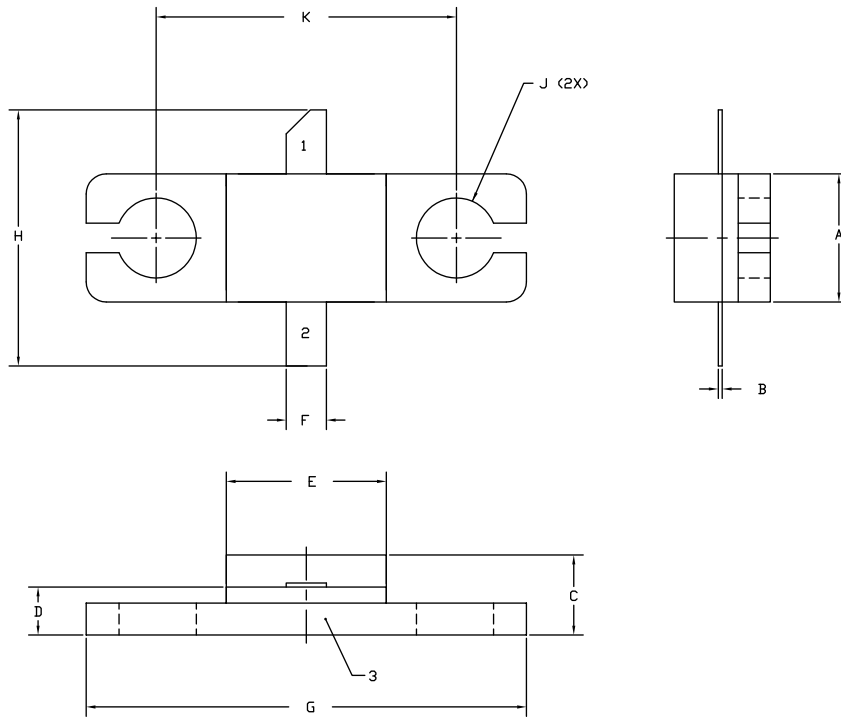

NOTES:

1. DIMENSIONING AND TOLERANCING PER ANSI Y14.5M, 1982.
2. CONTROLLING DIMENSION: INCH.
3. ADHESIVE FROM LID MAY EXTEND A MAXIMUM OF 0.020" BEYOND EDGE OF LID.
4. LID MAY BE MISALIGNED TO THE BODY OF THE PACKAGE BY A MAXIMUM OF 0.008" IN ANY DIRECTION.
5. ALL PLATED SURFACES ARE NI/AU

DIM	INCHES		MILLIMETERS	
	MIN	MAX	MIN	MAX
A	0.155	0.165	3.94	4.19
B	0.004	0.006	0.10	0.15
C	0.115	0.135	2.92	3.43
D	0.057	0.067	1.45	1.70
E	0.195	0.205	4.95	5.21
F	0.045	0.055	1.14	1.40
G	0.545	0.555	13.84	14.09
H	0.280	0.360	7.11	9.14
J	Ø .100		2.54	
K	0.375		9.53	

- PIN 1. GATE  
 PIN 2. DRAIN  
 PIN 3. SOURCE

**Product Dimensions CGH27015P (Package Type — 440196)**

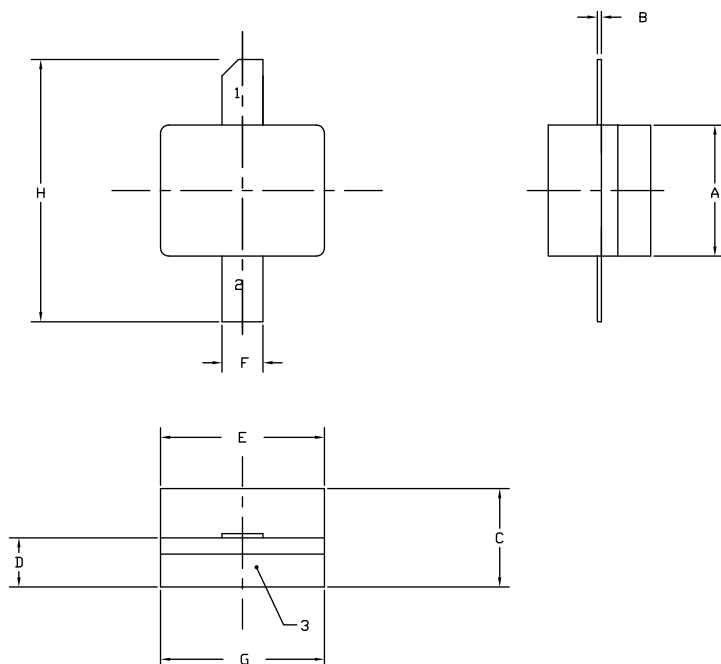



NOTES:

1. DIMENSIONING AND TOLERANCING PER ANSI Y14.5M, 1982.
2. CONTROLLING DIMENSION: INCH.
3. ADHESIVE FROM LID MAY EXTEND A MAXIMUM OF 0.020" BEYOND EDGE OF LID.
4. LID MAY BE MISALIGNED TO THE BODY OF THE PACKAGE BY A MAXIMUM OF 0.008" IN ANY DIRECTION.
5. ALL PLATED SURFACES ARE NI/AU

DIM	INCHES		MILLIMETERS	
	MIN	MAX	MIN	MAX
A	0.155	0.165	3.94	4.19
B	0.003	0.006	0.10	0.15
C	0.115	0.135	2.92	3.17
D	0.057	0.067	1.45	1.70
E	0.195	0.205	4.95	5.21
F	0.045	0.055	1.14	1.40
G	0.195	0.205	4.95	5.21
H	0.280	0.360	7.11	9.14

- PIN 1. GATE  
 PIN 2. DRAIN  
 PIN 3. SOURCE

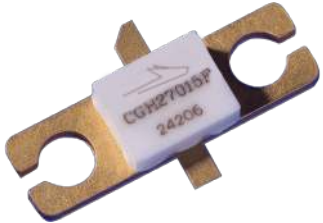
**Product Ordering Information**

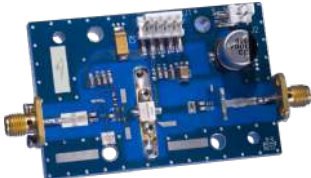
Order Number	Description	Unit of Measure	Image
CGH27015F	GaN HEMT	Each	
CGH27015P	GaN HEMT	Each	
CGH27015F-AMP	Test board with GaN HEMT installed	Each	

**For more information, please contact:**

4600 Silicon Drive  
Durham, NC 27703 USA  
Tel: +1.919.313.5300  
[www.wolfspeed.com/RF](http://www.wolfspeed.com/RF)

Sales Contact  
[RFSales@wolfspeed.com](mailto:RFSales@wolfspeed.com)

RF Product Marketing Contact  
[RFMarketing@wolfspeed.com](mailto:RFMarketing@wolfspeed.com)

## Notes & Disclaimer

---

Specifications are subject to change without notice. “Typical” parameters are the average values expected by Wolfspeed in large quantities and are provided for information purposes only. Wolfspeed products are not warranted or authorized for use as critical components in medical, life-saving, or life-sustaining applications, or other applications where a failure would reasonably be expected to cause severe personal injury or death. No responsibility is assumed by Wolfspeed for any infringement of patents or other rights of third parties which may result from use of the information contained herein. No license is granted by implication or otherwise under any patent or patent rights of Wolfspeed.

© 2005-2022 Wolfspeed, Inc. All rights reserved. Wolfspeed® and the Wolfstreak logo are registered trademarks and the Wolfspeed logo is a trademark of Wolfspeed, Inc.  
PATENT: <https://www.wolfspeed.com/legal/patents>

*The information in this document is subject to change without notice.*